



US00D911450S

(12) **United States Design Patent**  
**Peeters et al.**

(10) **Patent No.:** **US D911,450 S**  
(45) **Date of Patent:** **\*\* Feb. 23, 2021**

(54) **GAME BOARD WITH GAME BOARD COVER AND GAME PIECES**

(71) Applicant: **SMART N.V.**, Kontich (BE)

(72) Inventors: **Raf Peeters**, Lier (BE); **Leighton Meredith Rees**, Cirencester (GB)

(73) Assignee: **SMART N.V.**, Kontich (BE)

(\*\*) Term: **15 Years**

(21) Appl. No.: **29/688,148**

(22) Filed: **Apr. 18, 2019**

(30) **Foreign Application Priority Data**

Oct. 30, 2018 (EM) ..... 005813094

(51) **LOC (13) Cl.** ..... **21-01**

(52) **U.S. Cl.**  
USPC ..... **D21/336**

(58) **Field of Classification Search**

USPC ..... D21/334, 335-342, 355-359, 365, 318, D21/397, 351, 385, 386, 389, 404, 478, D21/479, 483-486, 489-491, 493, 494, D21/497, 499, 507, 510, 511, 561; 273/241, 242, 244-247, 259, 275-277, 273/281, 282.1-282.3, 284, 287, 317.3, 273/108.1, 108.5, 118 D, 236-240, 283, 273/309, 441, 461; D6/406.1, 406.3, D6/406.4, 406.6; D19/86, 92, 95, 87, D19/113, 75, 77, 78, 80; 108/14, 62, 43, 108/67; 434/416, 247, 248, 251, 408, 434/413, 145, 430

CPC .... A63F 3/00; A63F 3/00003; A63F 3/00028; A63F 3/00041; A63F 3/00044; A63F 3/00047; A63F 3/00173; A63F 3/00176; A63F 3/00214; A63F 3/00261; A63F 3/00643; A63F 3/00646-00659; A63F 3/04; A63F 3/00097; A63F 3/0434; A63F 3/00148; A63F 3/00697; A63F 3/0023; A63F 3/00895; A63F 3/00574; A63F 3/00694; A63F 2003/00182; A63F

2003/00223; A63F 2003/00457; A63F 2003/0046; A63F 2003/00463; A63F 2003/00466; A63F 2003/0047; A63F 2003/00485; A63F 2003/00492; A63F 2003/00507; A63F 2003/00514; A63F 2003/00533; A63F 2003/00552; A63F 2003/00558; A63F 2003/00943; A63F 2003/00946; A63F 2003/00952-00962; A63F 2003/00974; A63F 7/00; A63F 7/06; A63F 7/0612; A63F 7/0604; A63F 7/0616-0636; A63F 7/30; A63F 7/36; A63F 7/0005; A63F 7/0017; A63F 7/0023; A63F 2007/0035; A63F 2007/367; A63F 2007/3674; A63F 9/00; A63F 9/08; A63F 9/001; A63F 9/0826; A63F 9/0073; A63F 9/0078; A63F 9/0602; A63F 9/0613; A63F 9/12-1208; A63F 9/1288; A63F 2009/0012; A63F 2009/1212-2009/1228; A63F 2009/1292; A63F 2009/1296

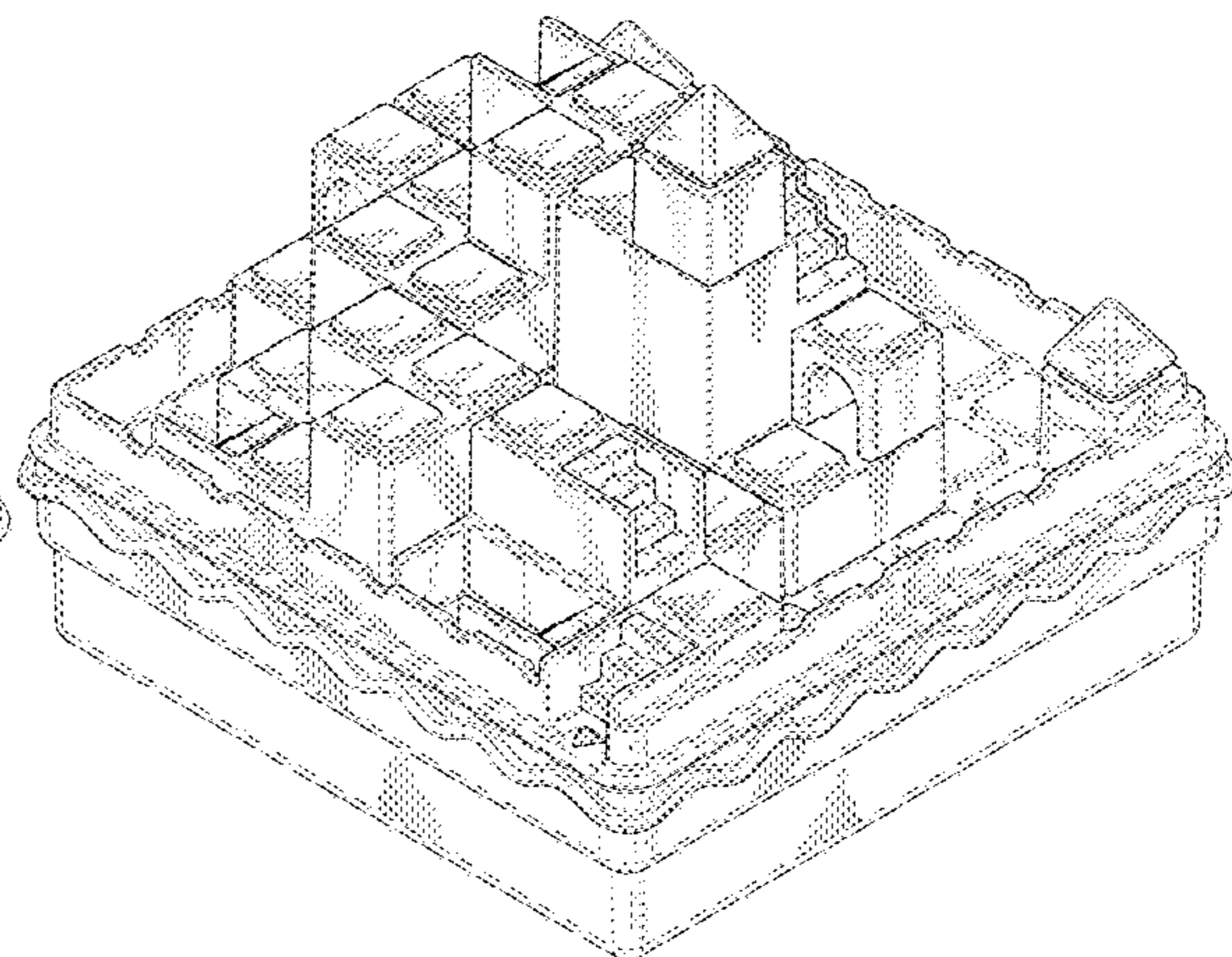
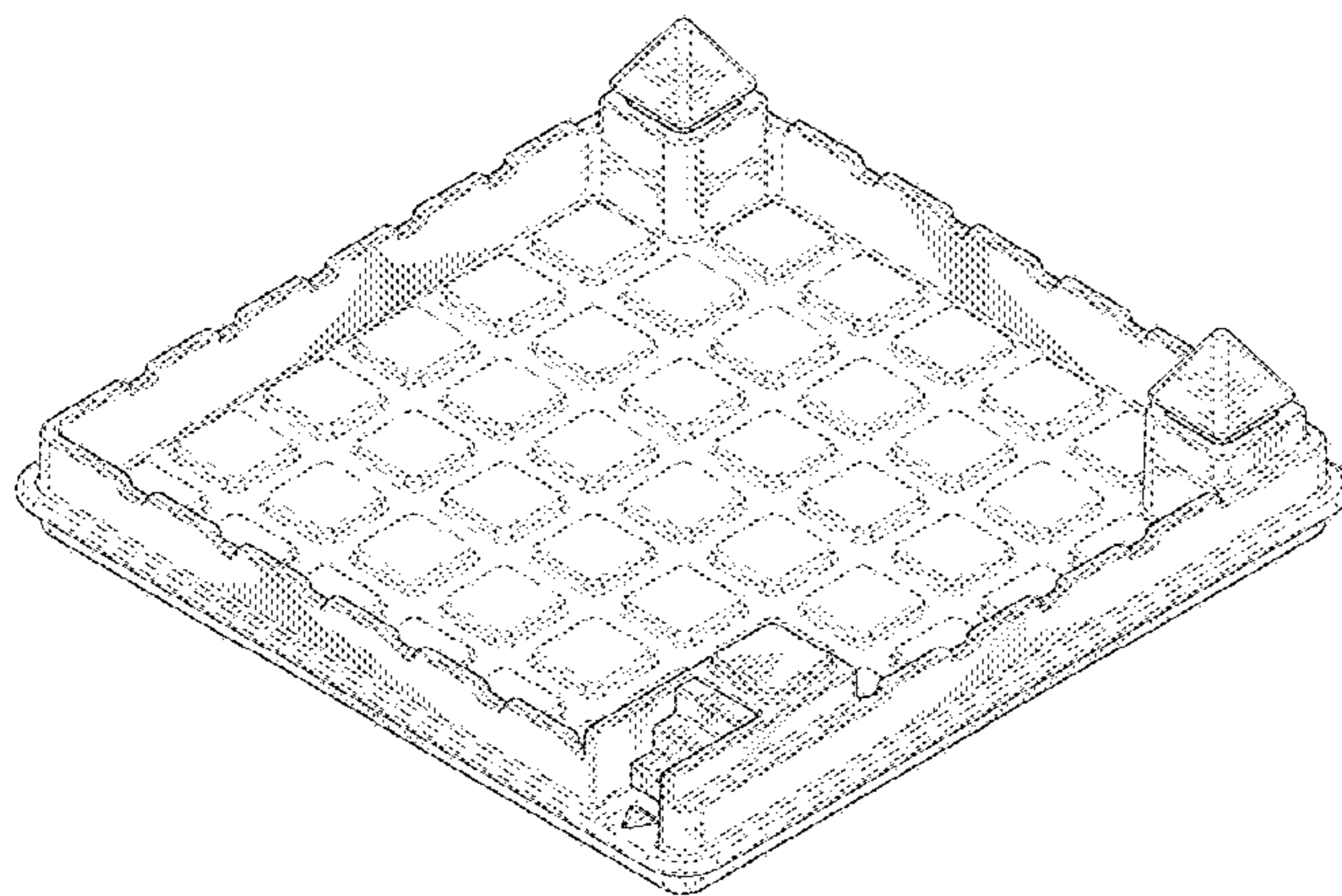
See application file for complete search history.

(56)

**References Cited**

**U.S. PATENT DOCUMENTS**

D17,127 S \* 2/1887 Clark ..... D19/103  
537,168 A \* 4/1895 Ormsby ..... A63F 9/0078  
273/153 R  
D55,496 S \* 6/1920 White ..... D7/590  
1,653,244 A \* 12/1927 White ..... A61J 7/0069  
206/459.5  
2,101,019 A \* 12/1937 Bowes ..... E04B 5/32  
249/18  
D110,770 S \* 8/1938 Alger ..... D21/335  
D111,647 S \* 10/1938 Alger ..... D21/335  
D115,126 S \* 6/1939 Petersen et al. .... D21/335  
D122,589 S \* 9/1940 Bastress ..... D7/553.5  
D133,824 S \* 9/1942 Young ..... D7/611  
D135,930 S \* 7/1943 Cobb ..... D21/342  
D137,722 S \* 4/1944 Triay ..... D21/366  
D137,887 S \* 5/1944 Shulman ..... D7/611  
D139,220 S \* 10/1944 Woodward et al. .... D21/366  
D143,719 S \* 2/1946 Ernster ..... D7/611  
D146,697 S \* 4/1947 Bates ..... D7/553.8  
D148,455 S \* 1/1948 Bleich et al. .... D19/92  
D150,414 S \* 8/1948 Gulley et al. .... D7/611





# US D911,450 S

2,501,379 A *	3/1950	Cranston	A47F 3/14 206/509	4,474,371 A *	10/1984	Silbermintz	A63F 9/1204 273/153 S
D160,848 S *	11/1950	Ernster	D7/611	D279,384 S *	6/1985	Evenson	D19/75
D162,742 S *	4/1951	Lorenzana et al.	D21/345	D280,290 S *	8/1985	Bakus	D9/425
D168,933 S *	3/1953	Gamble	D21/335	D282,265 S *	1/1986	Hyland	D21/336
D172,958 S *	9/1954	Ferrucci	D19/103	D283,012 S *	3/1986	Jankens	D32/55
2,704,927 A *	3/1955	Carrell	F25C 1/24 62/382	D283,164 S *	3/1986	Pandya	D19/75
2,757,934 A *	8/1956	Dunbar	A63F 3/0423 273/272	D285,318 S *	8/1986	Propsom	D21/341
D188,987 S *	10/1960	Swimmer	D21/336	4,648,524 A *	3/1987	Ackermann	A47B 88/969 220/507
D192,672 S *	4/1962	Jenkins	D24/230	D289,531 S *	4/1987	Coghill	D10/46.1
D197,134 S *	12/1963	Markham	D21/336	4,674,433 A *	6/1987	Inada	G09B 19/02 116/200
3,211,290 A *	10/1965	Strickling	B65B 21/18 209/522	D294,668 S *	3/1988	Handler	D6/569
3,273,700 A *	9/1966	Moreau et al.	B44D 3/04 206/1.7	D296,797 S *	7/1988	Andrews	D21/335
D206,761 S *	1/1967	Kirwan	D7/553.5	D297,441 S *	8/1988	Smith, III	D21/335
D210,542 S *	3/1968	Stookey	D21/336	4,783,081 A *	11/1988	Eckhardt	A63F 3/00261 273/281
D210,613 S *	3/1968	Moore	F25D 25/00 D7/611	D299,287 S *	1/1989	Gertler	D12/419
3,382,632 A *	5/1968	Grofcsik	E04B 2/10 52/223.7	D299,933 S *	2/1989	Shalaon	D21/336
D217,851 S *	6/1970	Yankovich	D3/313	4,819,945 A *	4/1989	Porcheddu	A63F 3/00634 273/272
D222,522 S *	10/1971	Zipf	D3/313	D301,575 S *	6/1989	Crawford, Jr.	D13/119
D223,026 S *	2/1972	Kotkow	D19/59	D302,026 S *	7/1989	Tu	D19/75
D223,714 S *	5/1972	Kester	D10/46.1	4,872,723 A *	10/1989	Kopf	B60N 3/002 297/216.1
D223,939 S *	6/1972	Palazzolo	D21/336	4,896,889 A *	1/1990	Kuhn	A63F 1/10 273/150
D225,241 S *	11/1972	Westlake	D21/336	D308,699 S *	6/1990	Ancona	D19/75
3,705,727 A *	12/1972	Breslow	A63F 3/06 273/271	D309,687 S *	8/1990	Embree	D6/552
D230,870 S *	3/1974	Keim	D21/336	D311,210 S *	10/1990	Bottcher	D19/103
D232,646 S *	9/1974	Stubbmann	D21/345	D319,348 S *	8/1991	Monteleon	D3/313
3,840,113 A *	10/1974	Bartleson	B44D 2/002 206/575	D320,619 S *	10/1991	Schleeh	D19/78
D234,781 S *	4/1975	White et al.	D21/336	5,052,549 A *	10/1991	Scharch	F42B 39/00 206/3
3,929,337 A *	12/1975	Hayes	A63F 3/00697 273/243	5,054,789 A *	10/1991	Pellerin	A63F 3/0423 273/288
3,940,212 A *	2/1976	Gutner	F16B 12/14 403/306	D321,431 S *	11/1991	Dunkeld	D12/419
D239,334 S *	3/1976	Lowenstein	D19/77	D335,796 S *	5/1993	Barnes	D7/553.5
D242,157 S *	11/1976	Missinich	D21/336	D338,808 S *	8/1993	Anderson	D7/549
D245,118 S *	7/1977	Heaton	D24/230	D350,478 S *	9/1994	Fuller	D3/203.3
D246,945 S *	1/1978	Shore	D7/549	D355,333 S *	2/1995	Campbell	D7/553.2
D247,533 S *	3/1978	Noyes	D6/514	D358,841 S *	5/1995	Ascone	D19/103
D247,647 S *	3/1978	Huber	D19/77	D363,091 S *	10/1995	Dobis	D21/336
4,123,062 A *	10/1978	Wexler	A63F 3/00 273/248	D363,856 S *	11/1995	Westbrooks, Jr.	D7/553.2
4,136,883 A *	1/1979	Klees	A63F 3/00261 273/281	D364,567 S *	11/1995	Dancel	D9/436
D251,644 S *	4/1979	Ravn	D6/571	D368,736 S *	4/1996	Massena	D19/103
D253,071 S *	10/1979	Montez	D24/181	D369,469 S *	5/1996	Gregory	D3/313
D253,126 S *	10/1979	Baxter	D24/226	D370,781 S *	6/1996	Vasudeva	D3/284
D253,127 S *	10/1979	Baxter	D24/226	5,560,612 A *	10/1996	Ippoliti	A63F 3/00574 273/272
D255,129 S *	5/1980	Strongin	D21/341	D381,515 S *	7/1997	Haynes	D24/224
D255,310 S *	6/1980	Spencer	D7/553.5	D393,543 S *	4/1998	Wilkening	D3/313
D256,081 S *	7/1980	Patterson	D3/311	5,738,108 A *	4/1998	Hein	A61B 5/411 600/556
4,237,906 A *	12/1980	Havstad	A61B 17/205 215/250	D394,750 S *	6/1998	Iversen	D3/313
4,244,581 A *	1/1981	Imatt	A63F 3/00574 273/236	D396,954 S *	8/1998	Iversen	D19/75
4,254,957 A *	3/1981	Kramer	A63F 3/00574 273/271	D396,955 S *	8/1998	Iversen	D19/75
D259,644 S *	6/1981	Israel	D21/336	D396,956 S *	8/1998	Iversen	D19/75
4,327,919 A *	5/1982	Vennor	A63F 3/00697 273/236	D408,061 S *	4/1999	Borg	D21/337
D264,857 S *	6/1982	Aitkens	D21/338	D411,308 S *	6/1999	Pandey	D24/216
D265,915 S *	8/1982	Tivey	D19/103	D419,772 S *	2/2000	Williams	D3/201
D266,728 S *	11/1982	Ivy	D7/693	D421,776 S *	3/2000	Borg	D21/336
D267,023 S *	11/1982	Bowser	D21/336	D434,456 S *	11/2000	Bracken	D21/336
D268,130 S *	3/1983	Easton	D24/230	D439,113 S *	3/2001	Claffy	D7/553.1
D268,353 S *	3/1983	Pilipski	D21/336	D443,299 S *	6/2001	Harrison	D19/103
D270,170 S *	8/1983	Shoptaugh	D21/342	D450,351 S *	11/2001	Fong	D21/335
D272,923 S *	3/1984	Quinn	273/148 R	6,345,822 B1 *	2/2002	Reynolds	A63F 3/00261 273/281
D274,789 S *	7/1984	Brown	D9/758	D457,371 S *	5/2002	Grassman	D6/552
D274,885 S *	7/1984	Joice	D9/758	D467,080 S *	12/2002	Zimmerman	D3/311
D276,116 S *	10/1984	Basil	D7/541	D467,980 S *	12/2002	Creech	D21/335
				D484,919 S *	1/2004	Campos	D21/335
				D490,244 S *	5/2004	Pero	D3/315
				D504,563 S *	5/2005	Broussard	D3/20
				D510,604 S *	10/2005	Deveaux, III	D21/335
				D513,124 S *	12/2005	Funk	D3/313
				D519,303 S *	4/2006	Winig	D6/682.2



D526,027 S \* 8/2006 Smith ..... D21/336  
 7,114,829 B2 \* 10/2006 Lai ..... F21S 10/02  
 362/231  
 D538,354 S \* 3/2007 Harman ..... D21/337  
 D539,359 S \* 3/2007 Rom ..... D21/478  
 7,219,895 B1 \* 5/2007 Hutchins, Jr. .... A63F 3/02  
 273/236  
 D545,379 S \* 6/2007 Floden ..... D21/346  
 D549,288 S \* 8/2007 Droznika ..... D21/341  
 D585,499 S \* 1/2009 Kramer ..... D21/335  
 D585,500 S \* 1/2009 Kramer ..... D21/335  
 D585,683 S \* 2/2009 Nielsen ..... D6/629  
 D589,626 S \* 3/2009 Petersen ..... D24/230  
 D592,401 S \* 5/2009 Beavers ..... D3/304  
 D596,758 S \* 7/2009 Constable ..... D24/230  
 D600,748 S \* 9/2009 Tabuchi ..... D19/106  
 D601,343 S \* 10/2009 Franczyk ..... D3/313  
 D606,774 S \* 12/2009 Kohli ..... D6/406.6  
 D607,516 S \* 1/2010 DeOreo ..... D21/335  
 D617,118 S \* 6/2010 Fojtasek ..... D6/382  
 D618,476 S \* 6/2010 Maddux ..... D6/705  
 D624,795 S \* 10/2010 Koeleman ..... D7/706  
 7,862,043 B2 \* 1/2011 Kramer ..... A63F 3/0023  
 273/283  
 D634,541 S \* 3/2011 Gutierrez ..... D3/313  
 D639,866 S \* 6/2011 Lévasseur ..... D21/342  
 D648,548 S \* 11/2011 Winer ..... D6/300  
 D651,538 S \* 1/2012 Garzone ..... D11/178  
 D656,201 S \* 3/2012 Perrin ..... D21/335  
 D657,824 S \* 4/2012 Sorrell ..... D21/365  
 D660,723 S \* 5/2012 Akana ..... D9/737  
 D661,950 S \* 6/2012 Greenwood ..... D7/590  
 D669,311 S \* 10/2012 Hsu ..... D7/553.5  
 8,302,801 B2 \* 11/2012 Fried ..... B65D 21/086  
 220/508  
 D674,709 S \* 1/2013 Akana ..... D9/737  
 8,381,662 B2 \* 2/2013 Goldszer ..... A47B 37/04  
 108/50.12  
 D678,409 S \* 3/2013 Papenfuß ..... D19/106  
 D680,379 S \* 4/2013 Lackey ..... D7/553.2  
 D685,654 S \* 7/2013 Akana ..... D9/737  
 D690,164 S \* 9/2013 Lock ..... D7/553.2  
 D695,078 S \* 12/2013 Hertaus ..... D7/600.1  
 D709,323 S \* 7/2014 Brown ..... D7/402  
 D713,051 S \* 9/2014 Smeja ..... D24/230  
 D714,958 S \* 10/2014 Smeja ..... D24/230  
 D729,549 S \* 5/2015 Williams ..... D6/675  
 D734,867 S \* 7/2015 Smeja ..... D24/230  
 D736,403 S \* 8/2015 Hudson ..... D24/226  
 D739,680 S \* 9/2015 Smeja ..... D7/600.1  
 D742,666 S \* 11/2015 Akana ..... D6/682.2  
 D744,159 S \* 11/2015 Lukas ..... D27/183  
 D746,637 S \* 1/2016 Mairinger ..... D7/553.2  
 D750,443 S \* 3/2016 Kraemer ..... D7/611  
 9,393,075 B2 \* 7/2016 Ghosh ..... A61B 46/10  
 D767,309 S \* 9/2016 Akana ..... D6/682.2  
 D769,678 S \* 10/2016 Jussen ..... D7/701  
 9,486,294 B2 \* 11/2016 Ghosh ..... A61B 50/13  
 D785,406 S \* 5/2017 Wansink ..... D7/553.2  
 D789,749 S \* 6/2017 Tsai ..... D7/600.1  
 D789,750 S \* 6/2017 Noe ..... D7/600.1  
 9,694,289 B2 \* 7/2017 Thomas ..... A63F 13/822  
 D793,813 S \* 8/2017 Dubois ..... D7/553.2  
 D793,856 S \* 8/2017 Akana ..... D9/425  
 D795,704 S \* 8/2017 Tanus ..... D9/737  
 9,788,913 B2 \* 10/2017 Ghosh ..... A61B 46/00  
 D802,678 S \* 11/2017 Wimer ..... D21/336  
 D804,261 S \* 12/2017 Almaguer ..... D7/701  
 D807,129 S \* 1/2018 Martinez ..... D7/701  
 D820,330 S \* 6/2018 Di Monte, Sr. .... D15/140  
 D820,623 S \* 6/2018 Akana ..... D6/682.4  
 D820,690 S \* 6/2018 Canuto ..... D9/757  
 D826,425 S \* 8/2018 Muller ..... D24/230  
 D826,426 S \* 8/2018 Muller ..... D24/230  
 D827,432 S \* 9/2018 Akana ..... D9/436  
 D834,365 S \* 11/2018 Hundley ..... D7/391  
 D836,832 S \* 12/2018 Kesselman ..... D27/186  
 D836,991 S \* 1/2019 Wansink ..... D7/553.5  
 D838,553 S \* 1/2019 Kraemer ..... D7/611

10,166,464 B2 \* 1/2019 Todokoro ..... A63F 9/0803  
 D840,053 S \* 2/2019 Kamees ..... D24/230  
 D840,249 S \* 2/2019 Payne ..... D9/760  
 D844,375 S \* 4/2019 Hundley ..... D7/391  
 D844,806 S \* 4/2019 Johns ..... D24/227  
 D859,979 S \* 9/2019 Akana ..... D9/432  
 D863,449 S \* 10/2019 Shoptaugh ..... D21/342  
 D864,304 S \* 10/2019 Macadam ..... D21/337  
 D872,187 S \* 1/2020 Hsu ..... D21/343  
 D873,572 S \* 1/2020 Hofer ..... D4/134  
 D873,660 S \* 1/2020 Akana ..... D9/436  
 D884,798 S \* 5/2020 Hsu ..... D21/342  
 D886,202 S \* 6/2020 Hsu ..... D21/342  
 D897,449 S \* 9/2020 Xu ..... D21/468  
 2002/0113370 A1 \* 8/2002 Pickering ..... A63F 3/00094  
 273/271  
 2003/0006553 A1 \* 1/2003 Veguilla ..... A63F 3/02  
 273/281  
 2005/0265129 A1 \* 12/2005 Agnoff ..... G04B 3/006  
 368/206  
 2006/0283767 A1 \* 12/2006 White West ..... A45D 19/00  
 206/557

\* cited by examiner

Primary Examiner — Susan Moon Lee

(74) Attorney, Agent, or Firm — Hodgson Russ LLP

(57) CLAIM

We claim the ornamental design for a game board with game board cover and game pieces, as shown and described.

DESCRIPTION

FIG. 1 is a top perspective view of a game board with game board cover and game pieces according to the present design, showing the game board apart from the game board cover and game pieces for clarity of illustration; FIG. 2 is a front elevational view of the game board of FIG. 1; FIG. 3 is a rear elevational view of the game board of FIG. 1; FIG. 4 is a right side view of the game board of FIG. 1; FIG. 5 is a left side view of the game board of FIG. 1; FIG. 6 is a top view of the game board of FIG. 1; FIG. 7 is a bottom view of the game board of FIG. 1; FIG. 8 is a top perspective view of the game board cover component, shown separately for clarity of illustration; FIG. 9 is a front elevational view of the game board cover of FIG. 8; FIG. 10 is a rear elevational view of the game board cover of FIG. 8; FIG. 11 is a left side view of the game board cover of FIG. 8; FIG. 12 is a right side view of the game board cover of FIG. 8; FIG. 13 is a top view of the game board cover of FIG. 8; FIG. 14 is a bottom view of the game board cover of FIG. 8; FIG. 15 is a top perspective view of a game piece, shown separately for clarity of illustration; FIG. 16 is a front elevational view of the game piece of FIG. 15; FIG. 17 is a rear elevational view of the game piece of FIG. 15; FIG. 18 is a left side view of the game piece of FIG. 15; FIG. 19 is a right side view of the game piece of FIG. 15; FIG. 20 is a top view of the game piece of FIG. 15; FIG. 21 is a bottom view of the game piece of FIG. 15;

FIG. 22 is a top perspective view of a game piece, shown separately for clarity of illustration;  
FIG. 23 is a front elevational view of the game piece of FIG. 22;  
FIG. 24 is a rear elevational view of the game piece of FIG. 22;  
FIG. 25 is a left side view of the game piece of FIG. 22;  
FIG. 26 is a right side view of the game piece of FIG. 22;  
FIG. 27 is a top view of the game piece of FIG. 22;  
FIG. 28 is a bottom view of the game piece of FIG. 22;  
FIG. 29 is a top perspective view of a game piece, shown separately for clarity of illustration;  
FIG. 30 is a front elevational view of the game piece of FIG. 29;  
FIG. 31 is a rear elevational view of the game piece of FIG. 29;  
FIG. 32 is a left side view of the game piece of FIG. 29;  
FIG. 33 is a right side view of the game piece of FIG. 29;  
FIG. 34 is a top view of the game piece of FIG. 29;  
FIG. 35 is a bottom view of the game piece of FIG. 29;  
FIG. 36 is a top perspective view of a game piece, shown separately for clarity of illustration;  
FIG. 37 is a front elevational view of the game piece of FIG. 36;  
FIG. 38 is a rear elevational view of the game piece of FIG. 36;  
FIG. 39 is a left side view of the game piece of FIG. 36;  
FIG. 40 is a right side view of the game piece of FIG. 36;

FIG. 41 is a top view of the game piece of FIG. 36;  
FIG. 42 is a bottom view of the game piece of FIG. 36;  
FIG. 43 is a top perspective view of a game piece, shown separately for clarity of illustration;  
FIG. 44 is a front elevational view of the game piece of FIG. 43;  
FIG. 45 is a rear elevational view of the game piece of FIG. 43;  
FIG. 46 is a right side view of the game piece of FIG. 43;  
FIG. 47 is a left side view of the game piece of FIG. 43;  
FIG. 48 is a top view of the game piece of FIG. 43;  
FIG. 49 is a bottom view of the game piece of FIG. 43;  
FIG. 50 is a top perspective view of a game piece, shown separately for clarity of illustration;  
FIG. 51 is a front elevational view of the game piece of FIG. 50;  
FIG. 52 is a rear elevational view of the game piece of FIG. 50;  
FIG. 53 is a left side view of the game piece of FIG. 50;  
FIG. 54 is a right side view of the game piece of FIG. 50;  
FIG. 55 is a top view of the game piece of FIG. 50;  
FIG. 56 is a bottom view of the game piece of FIG. 50; and,  
FIG. 57 is a top perspective view of the game board with game board cover and game pieces.  
The broken lines illustrate portions of the game board with game board cover and game pieces that form no part of the claim but are included for purposes of illustration.

**1 Claim, 42 Drawing Sheets**



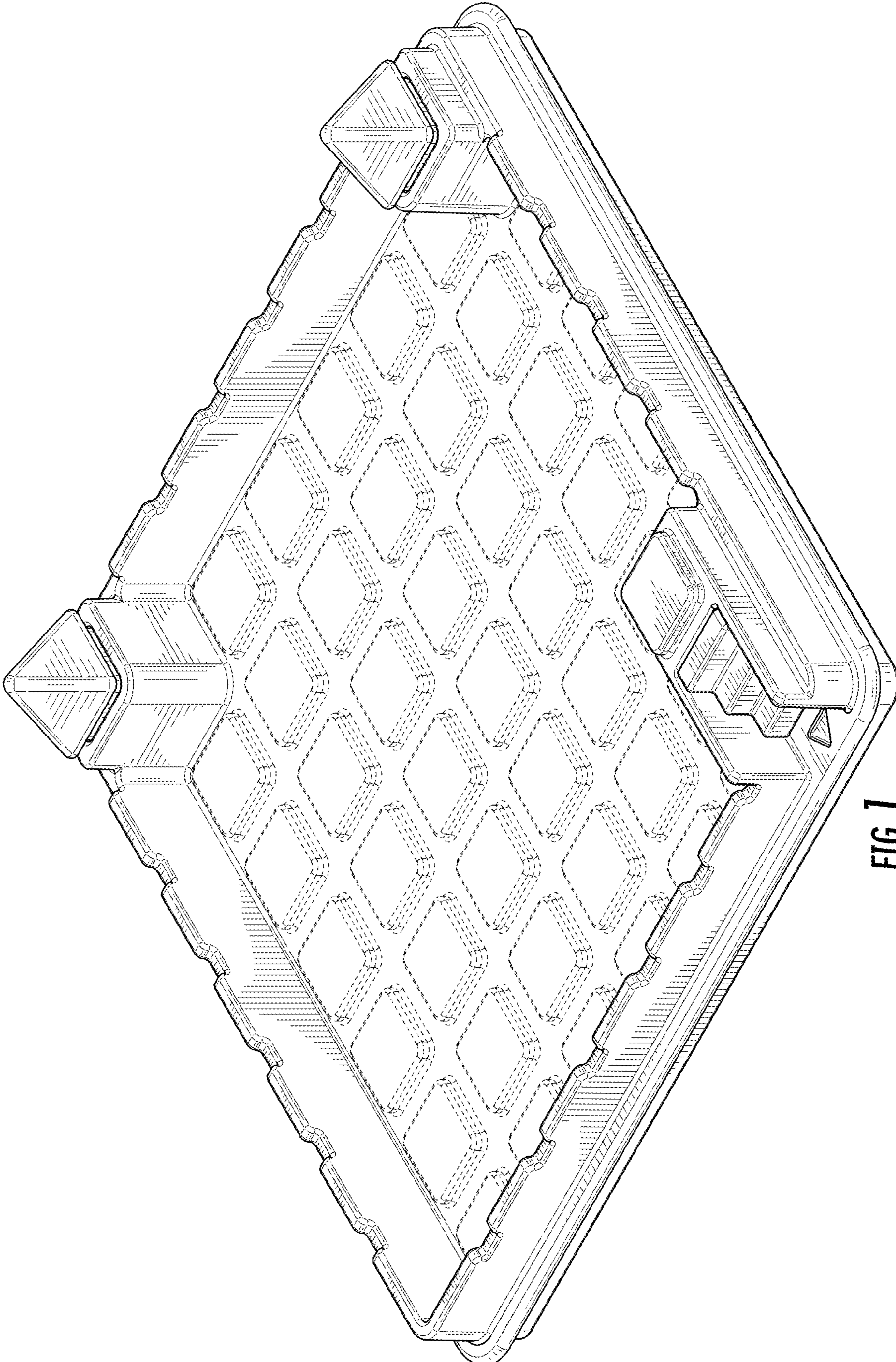
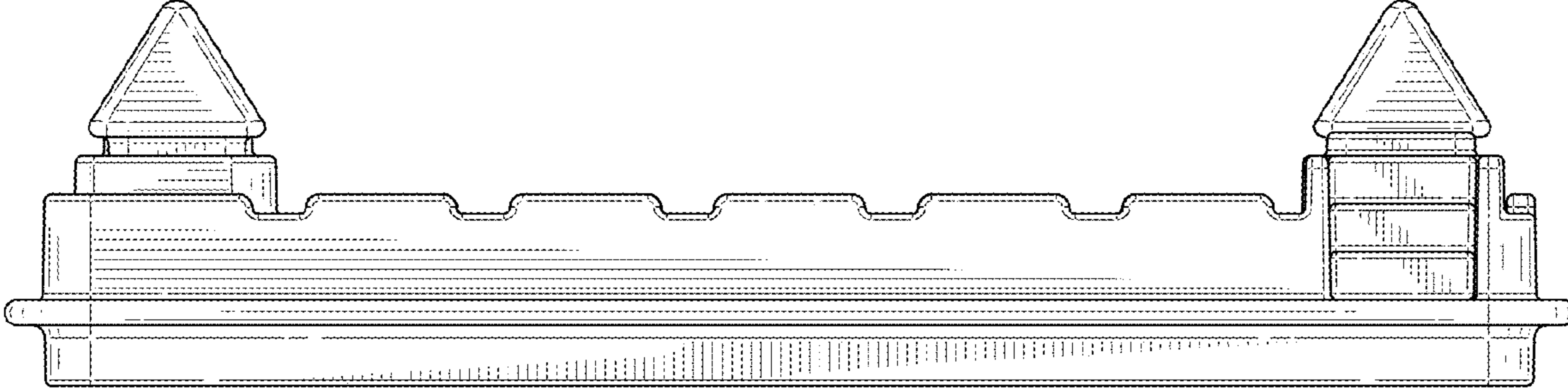
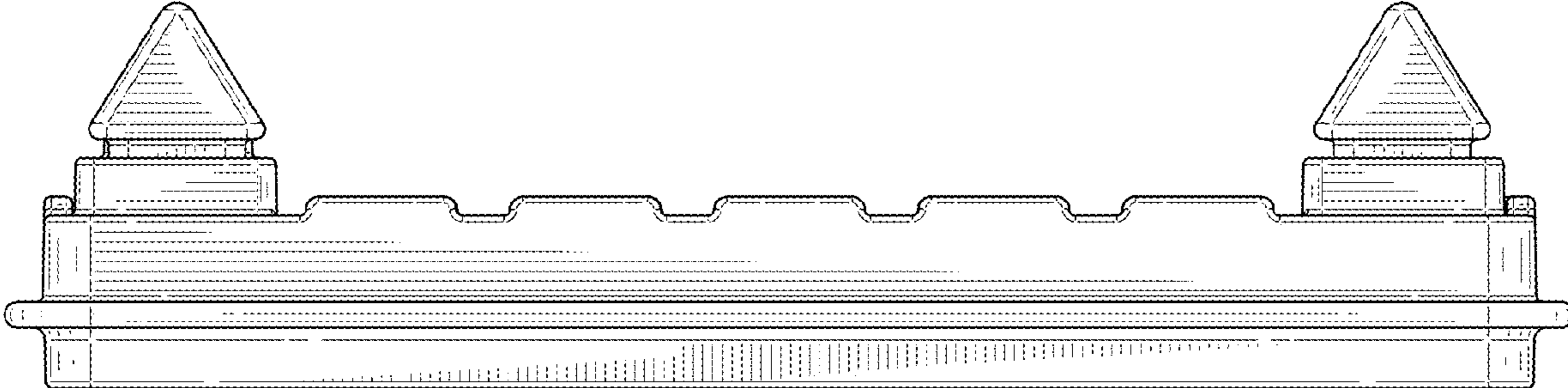


FIG. 1



**FIG. 2**



**FIG. 3**

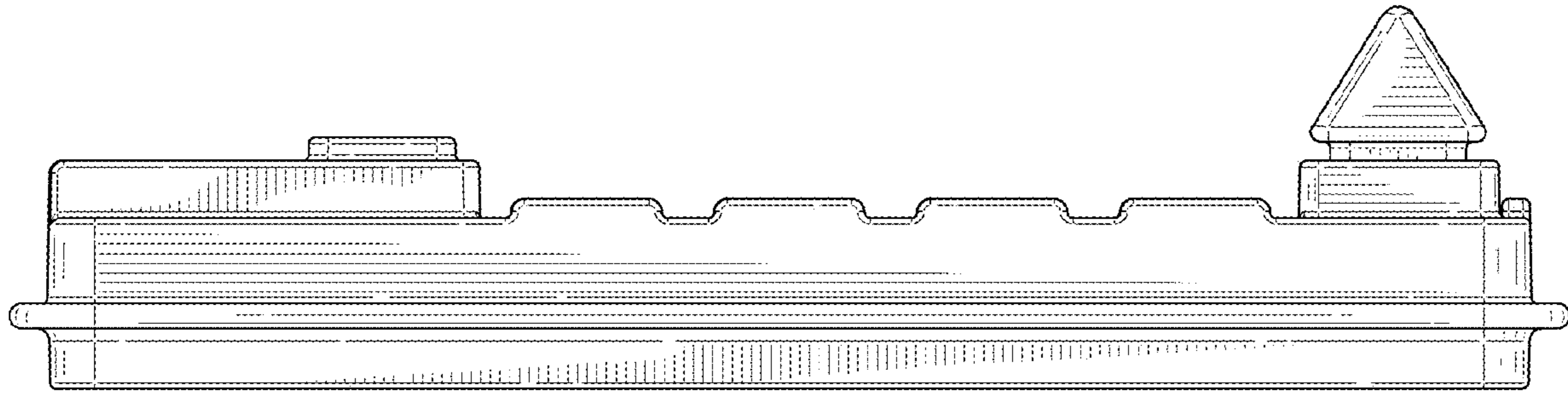


FIG. 4

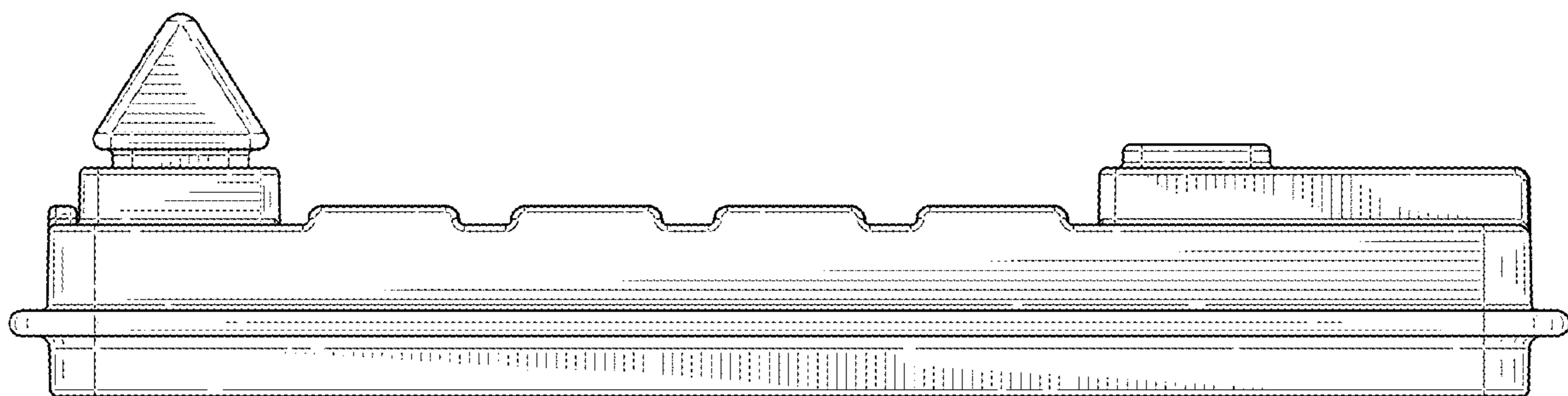


FIG. 5



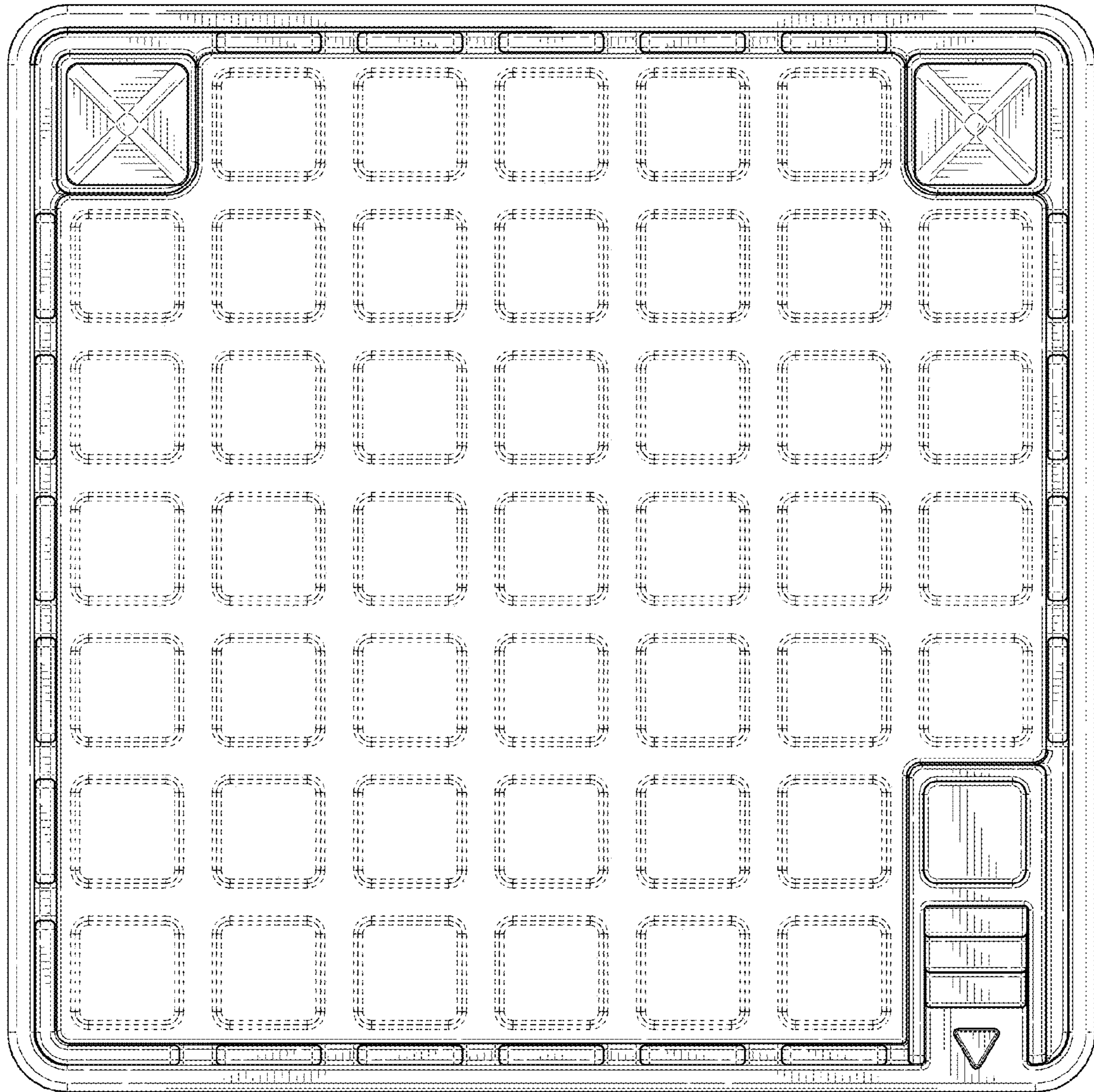


FIG. 6



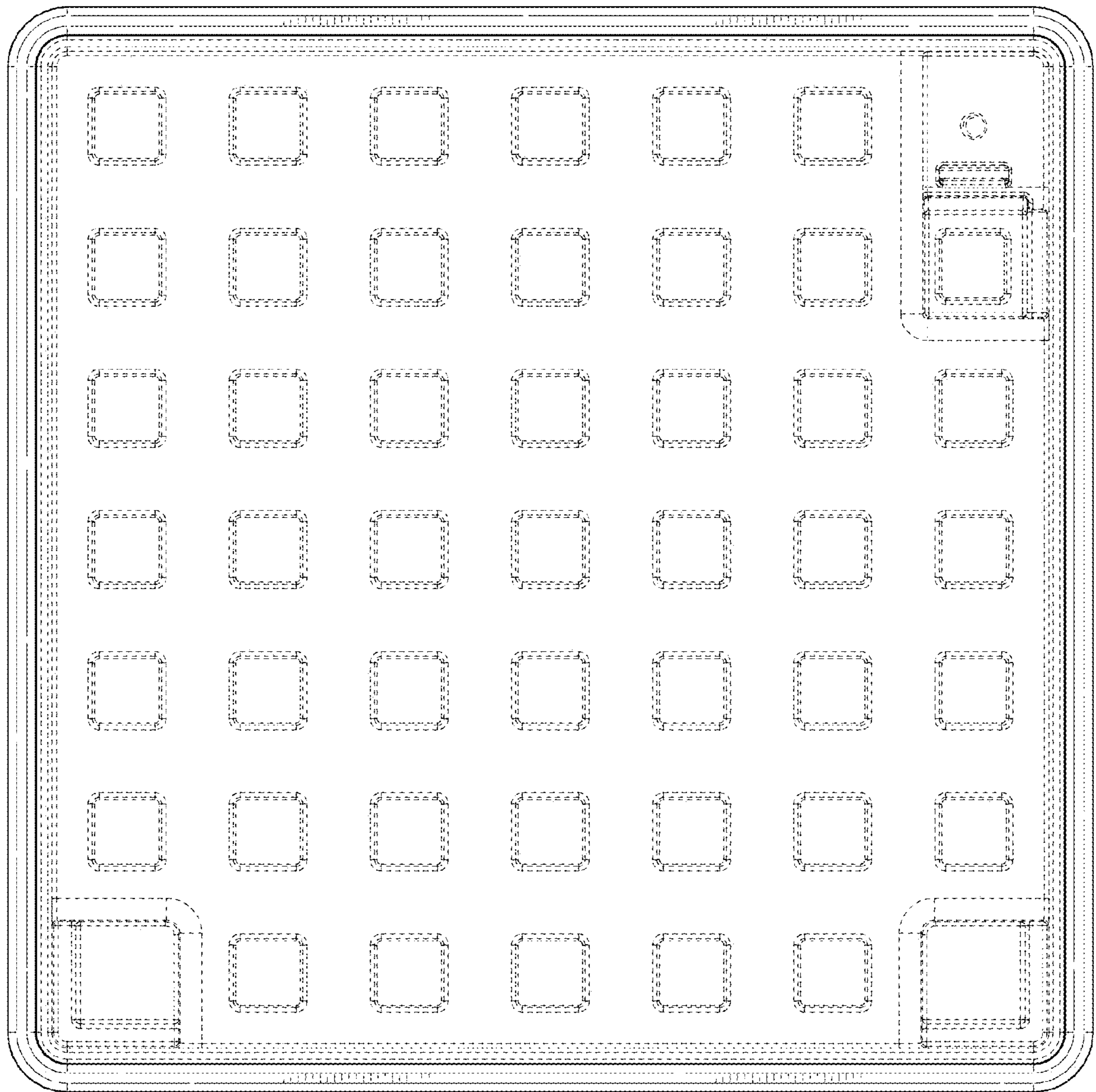


FIG. 7

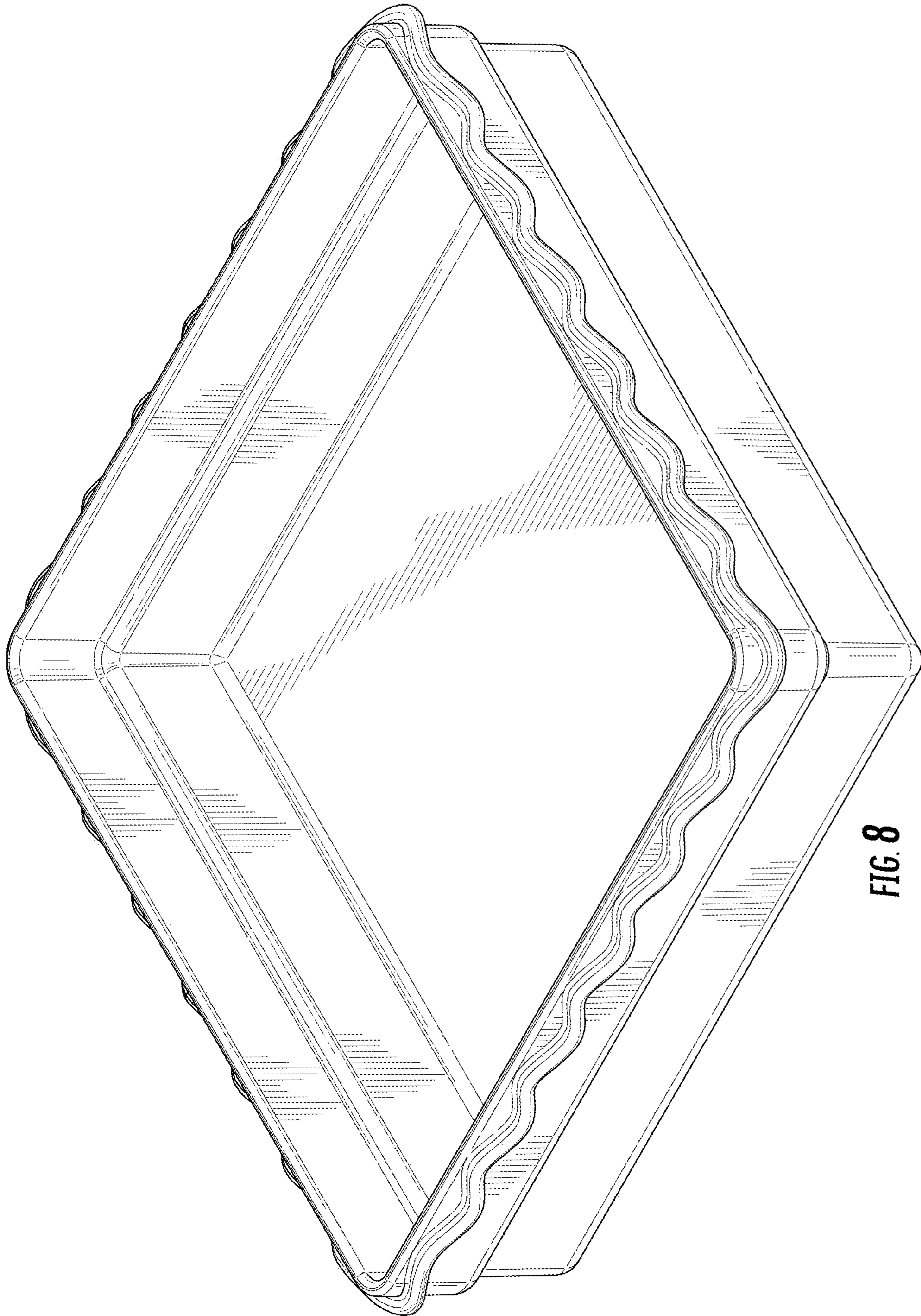
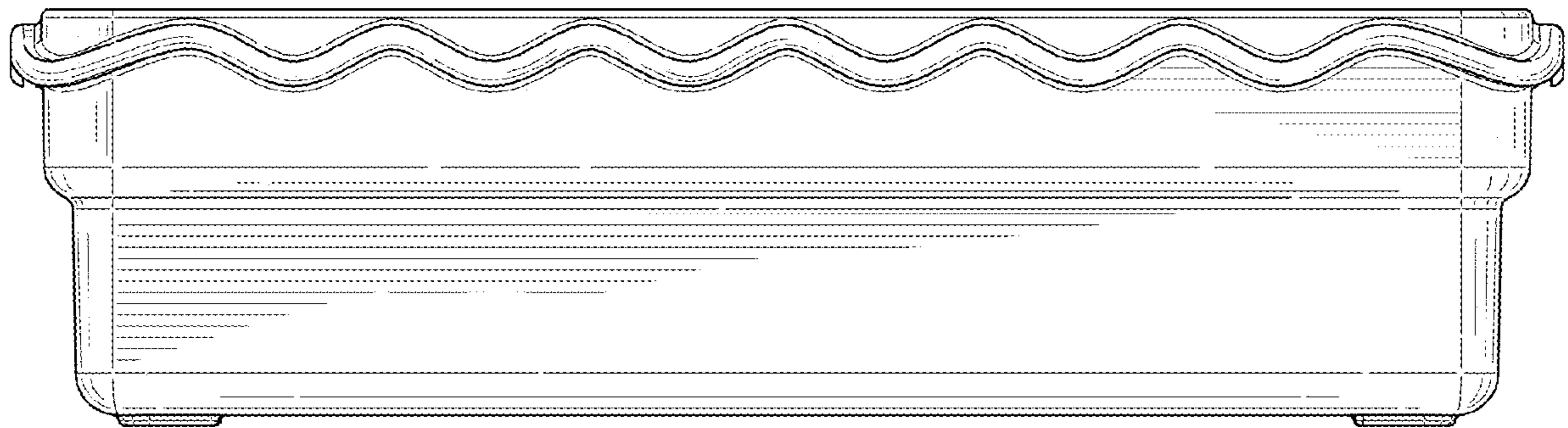
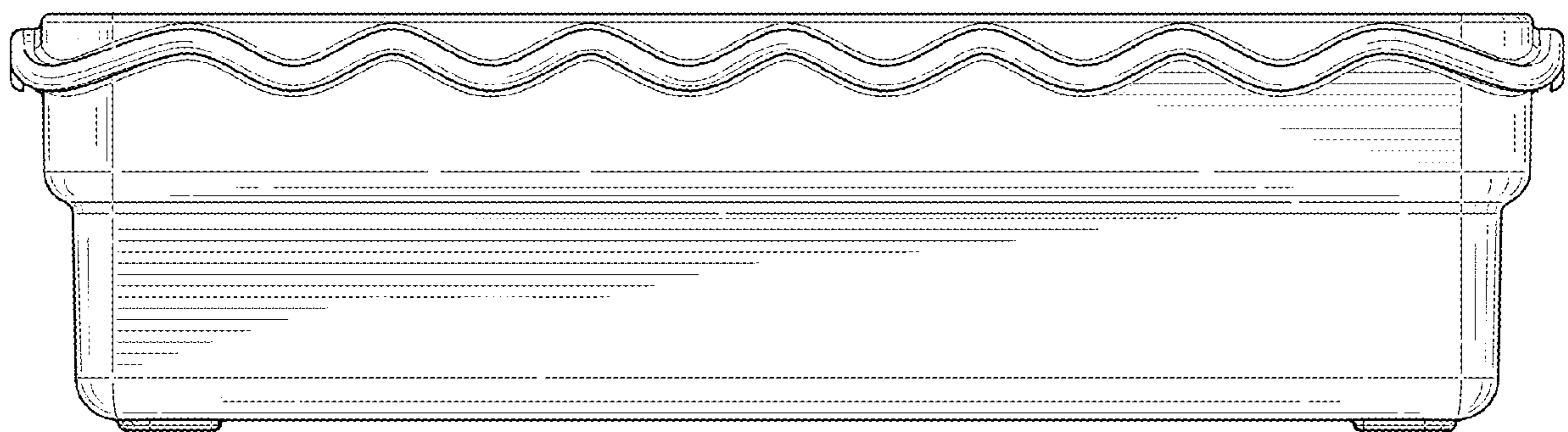


FIG. 8

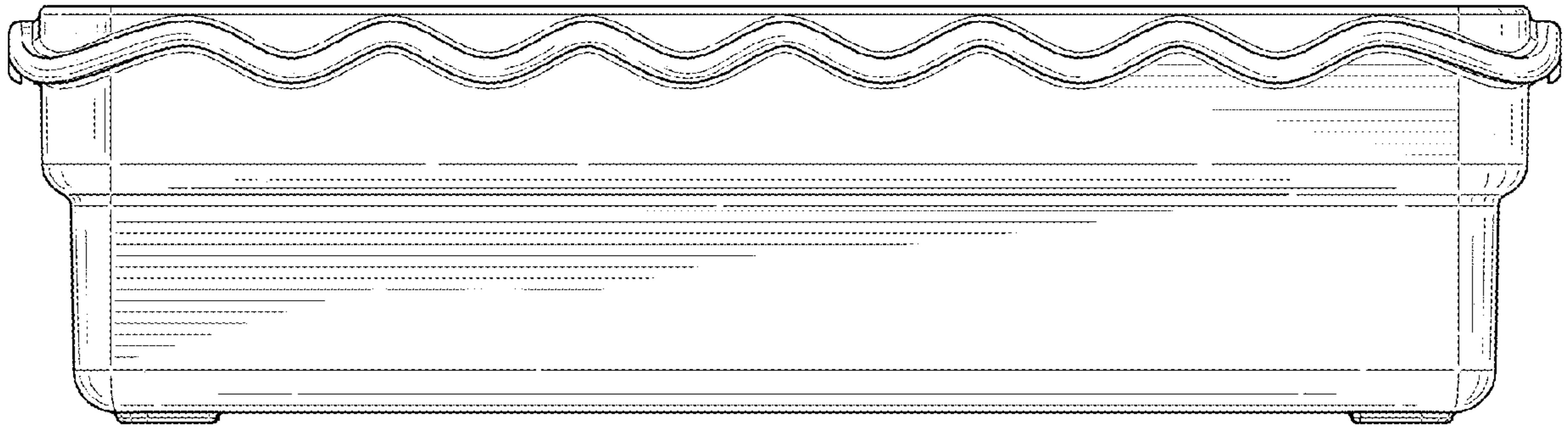




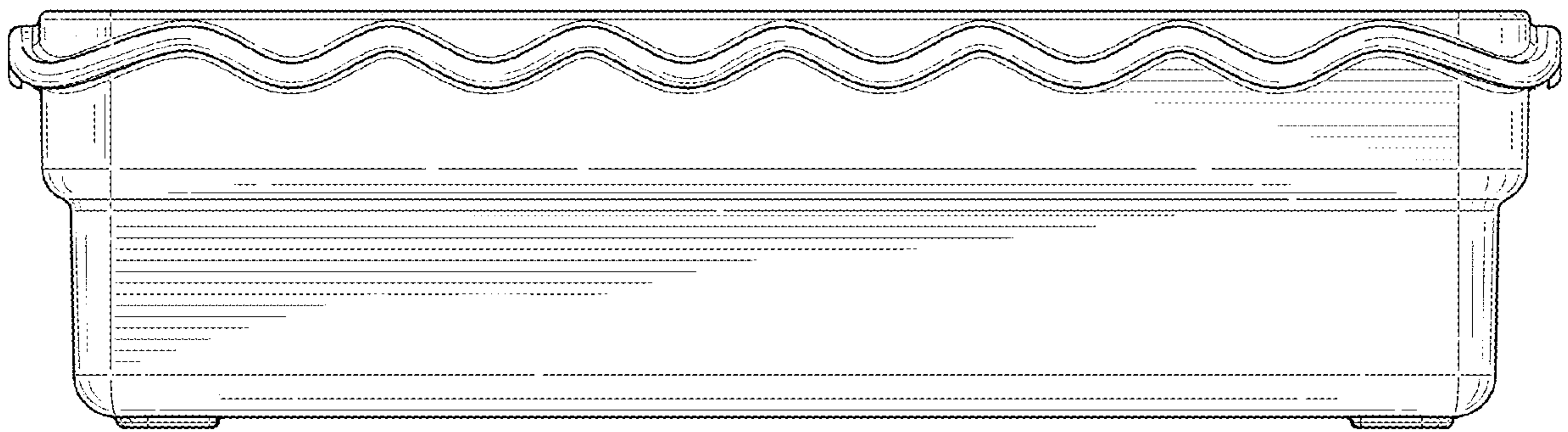
**FIG. 9**



**FIG. 10**



**FIG. 11**



**FIG. 12**



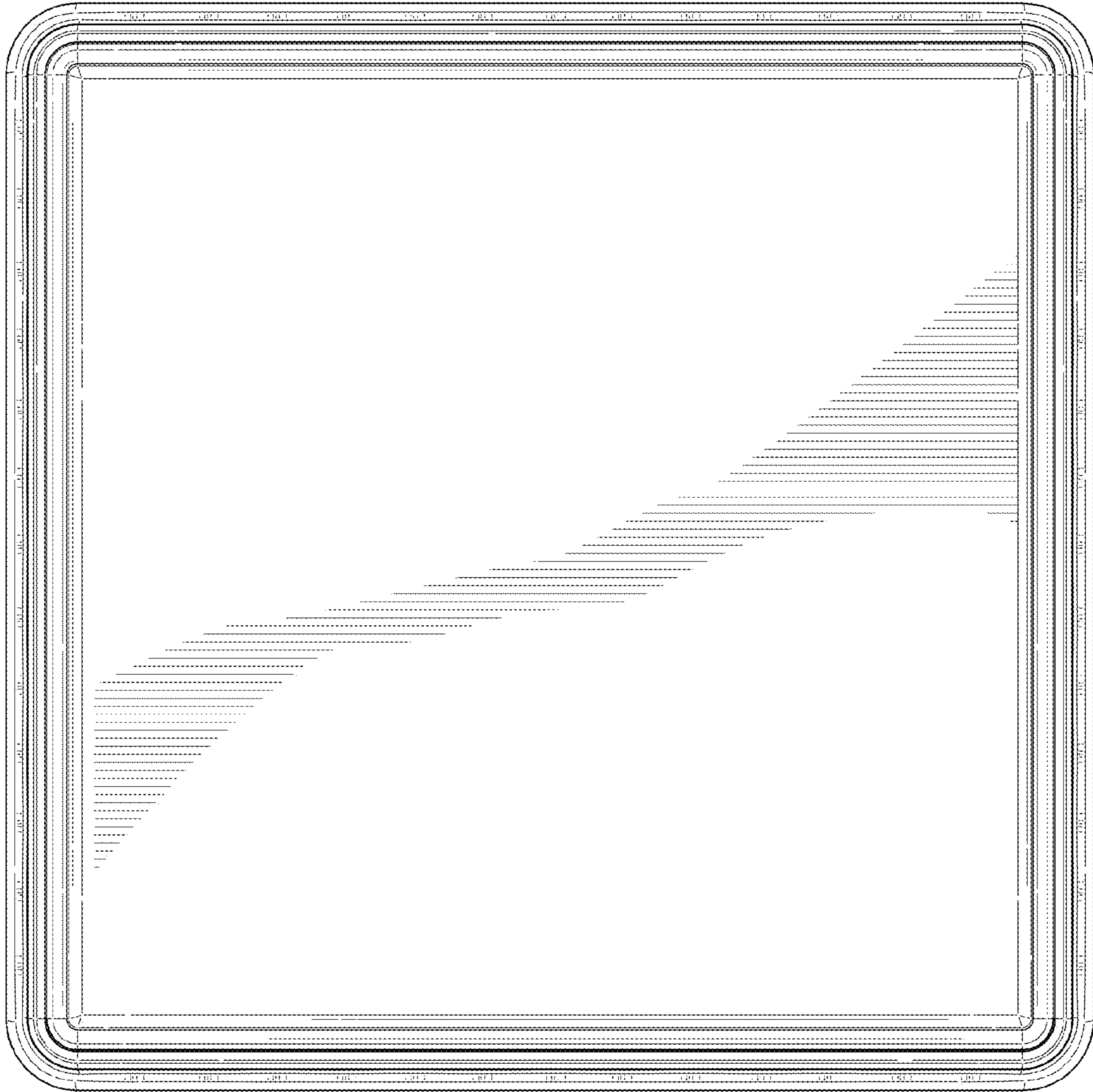


FIG. 13

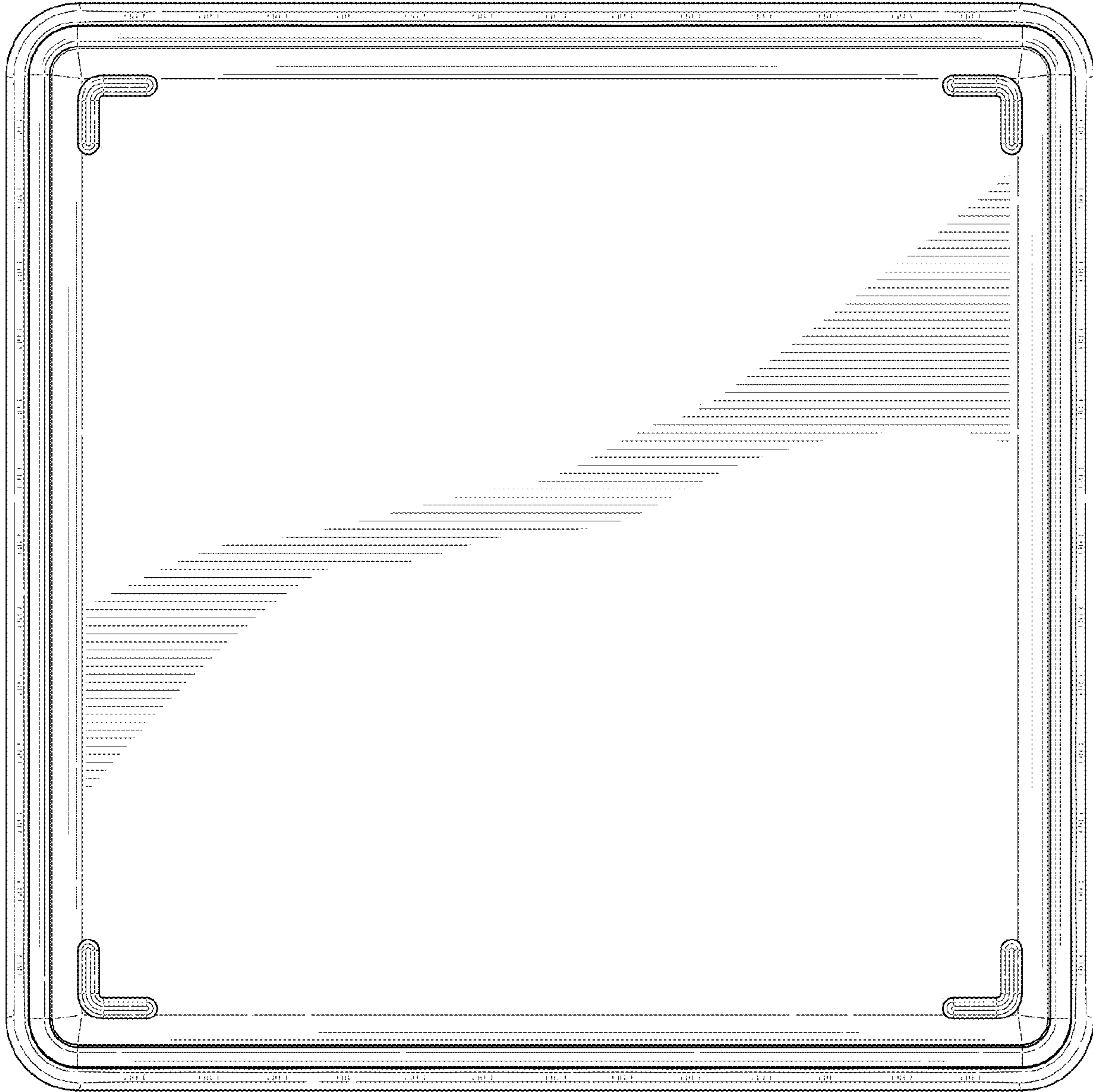
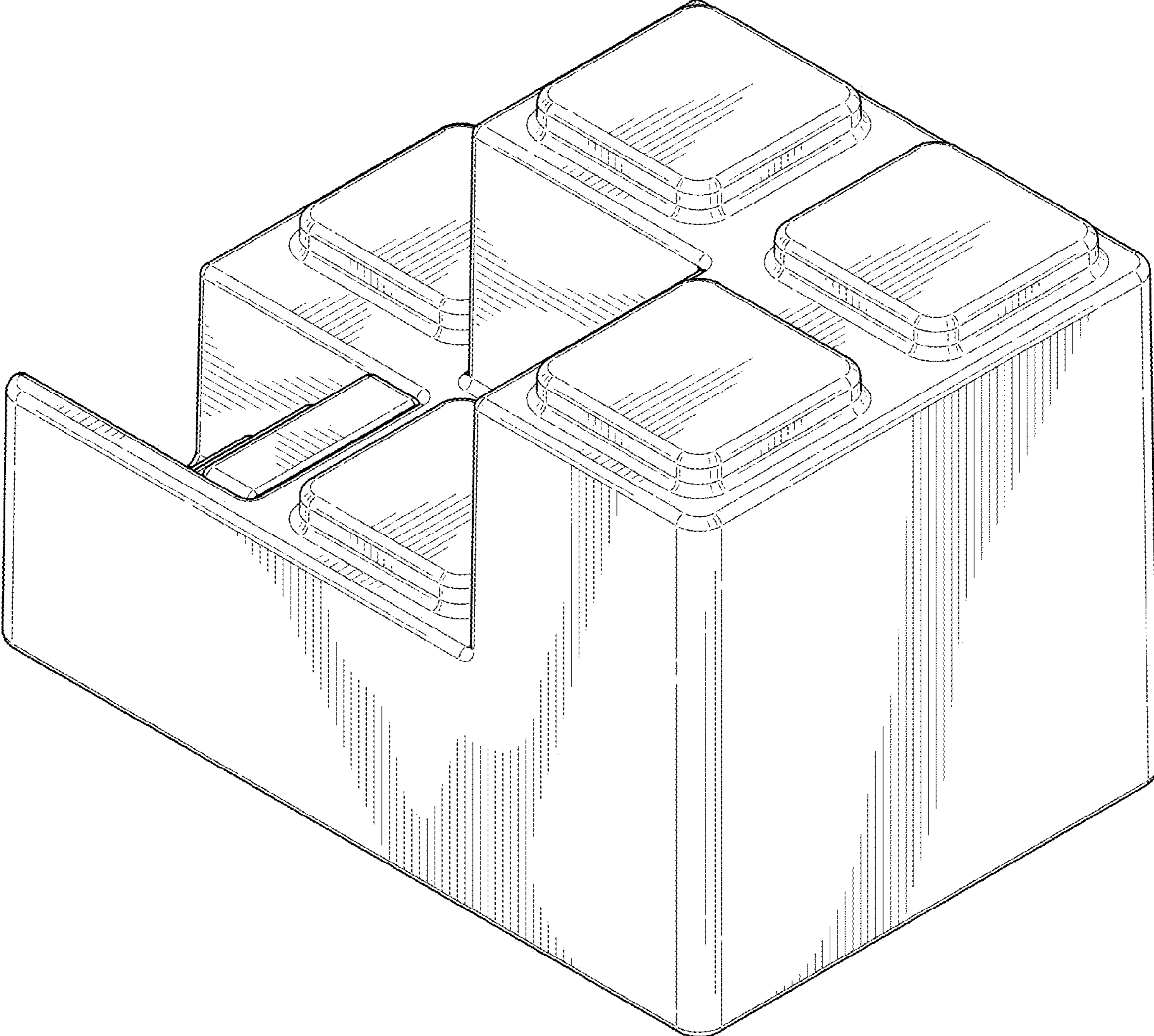
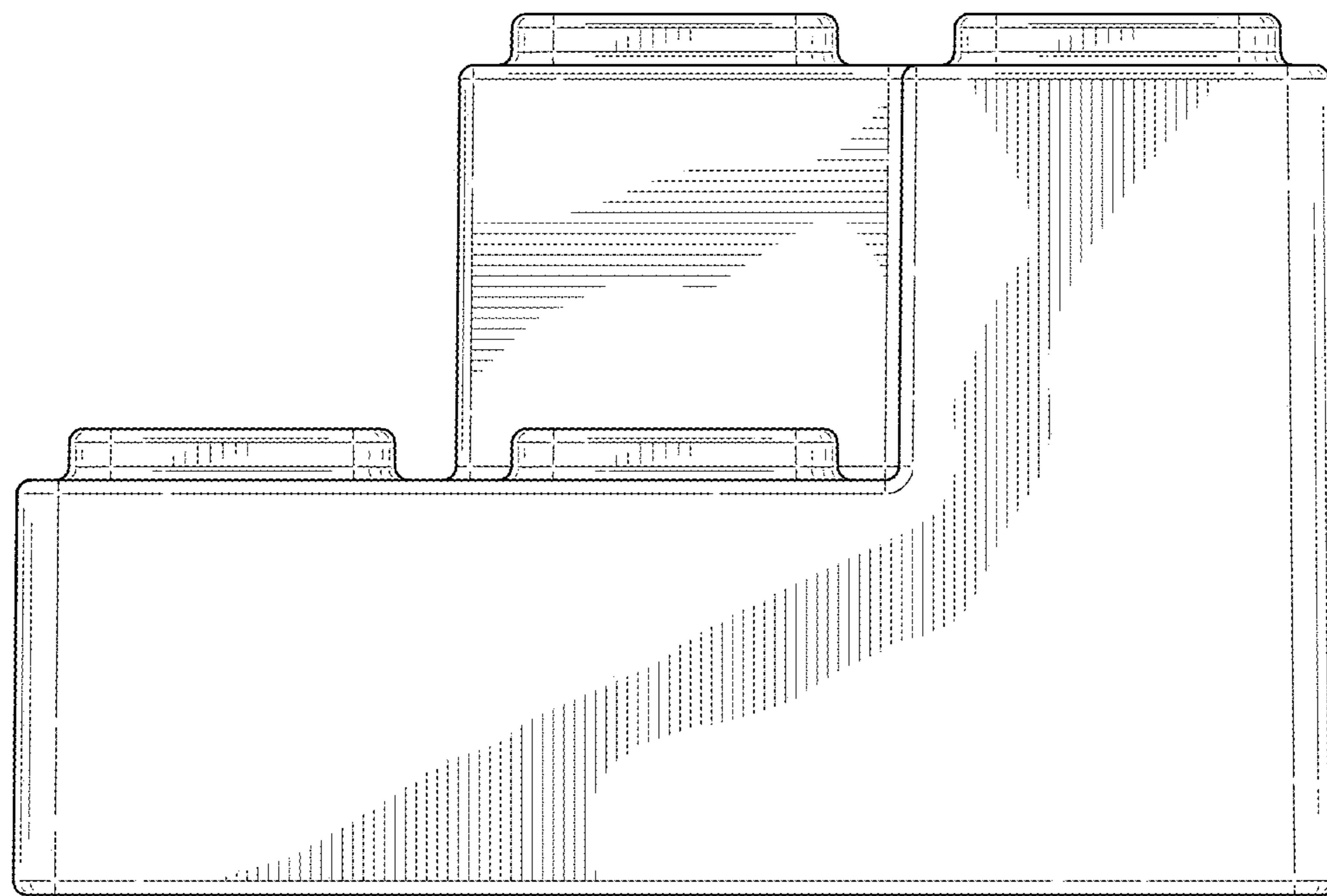


FIG. 14

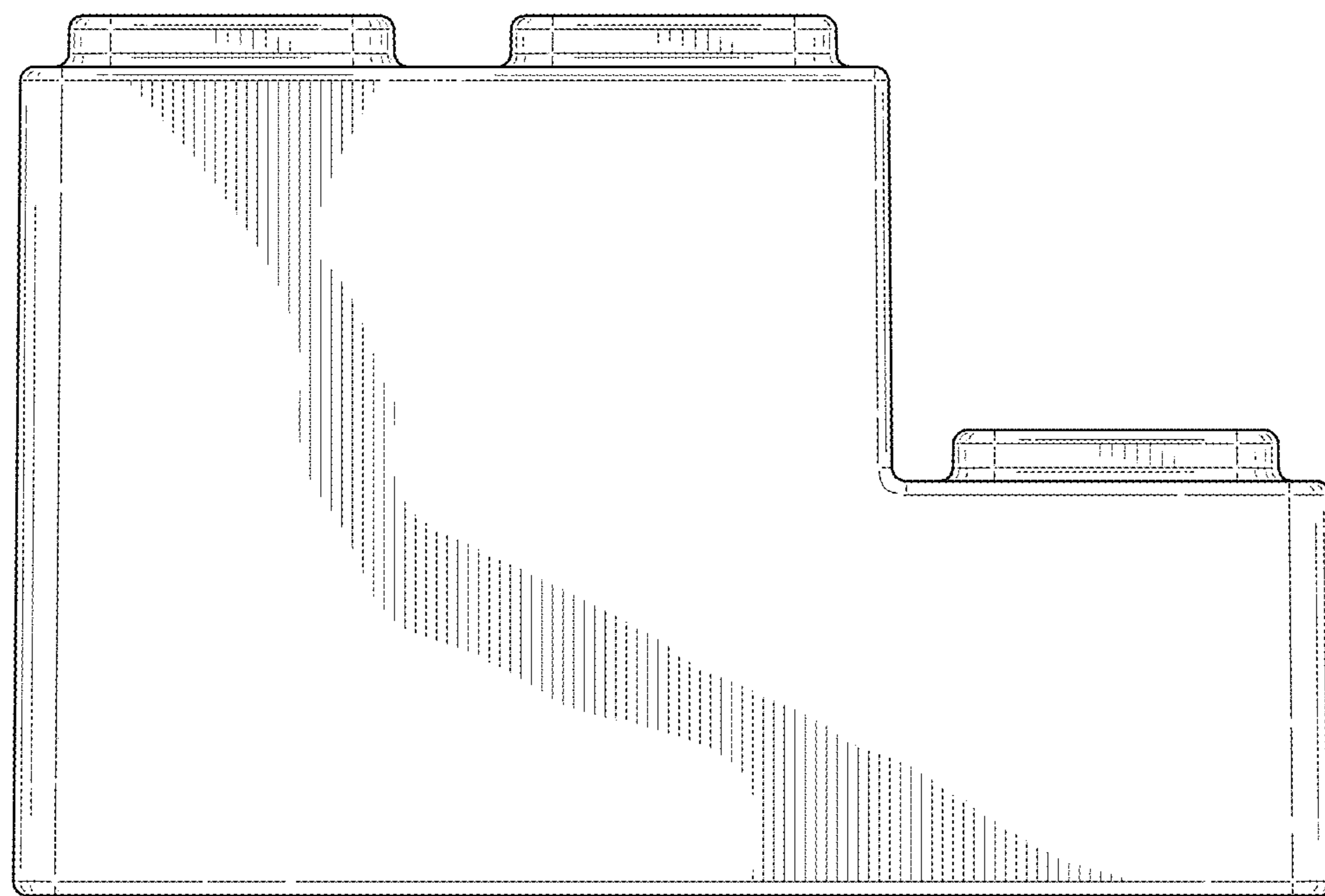




**FIG. 15**

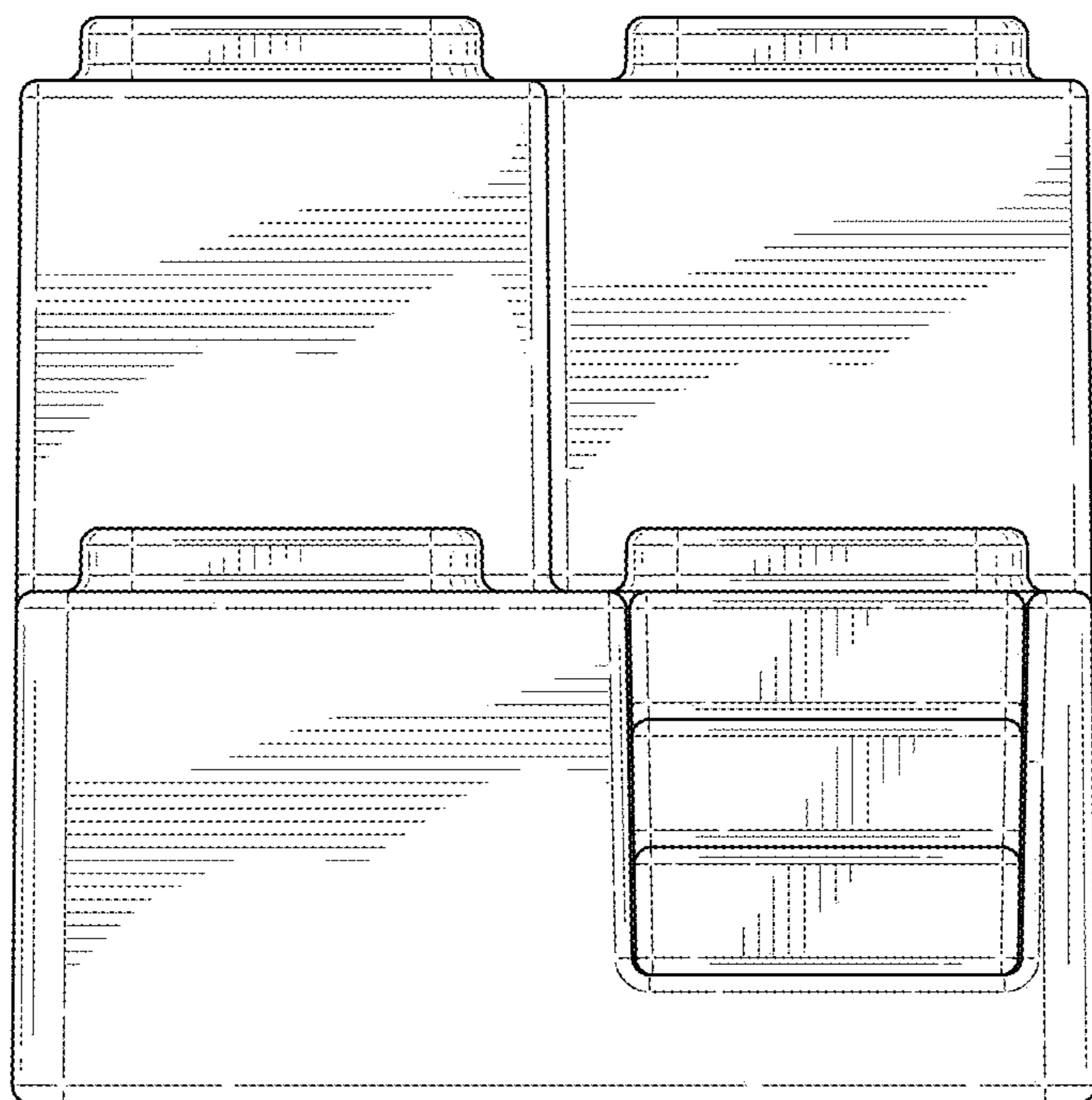


**FIG. 16**

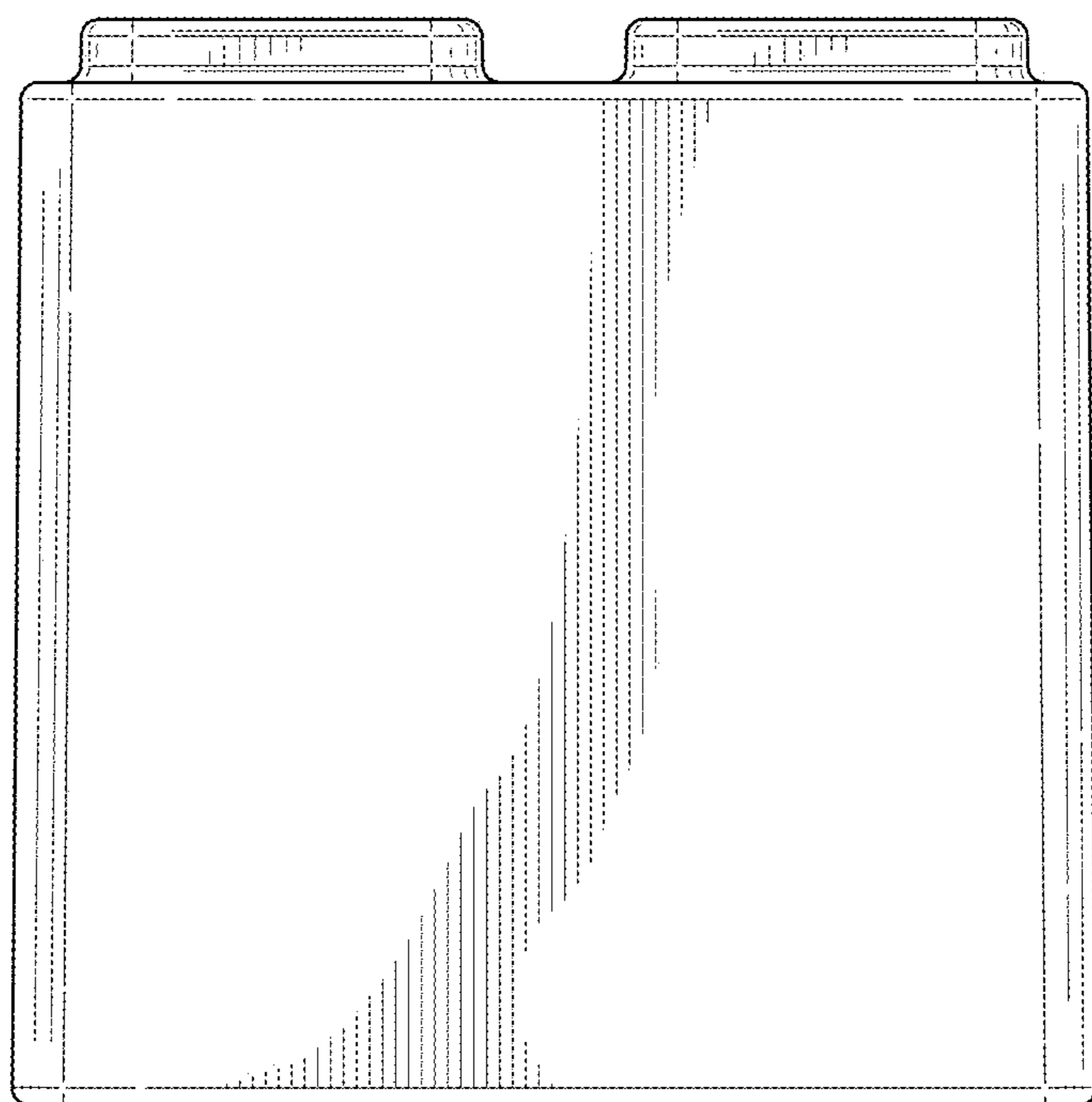


**FIG. 17**

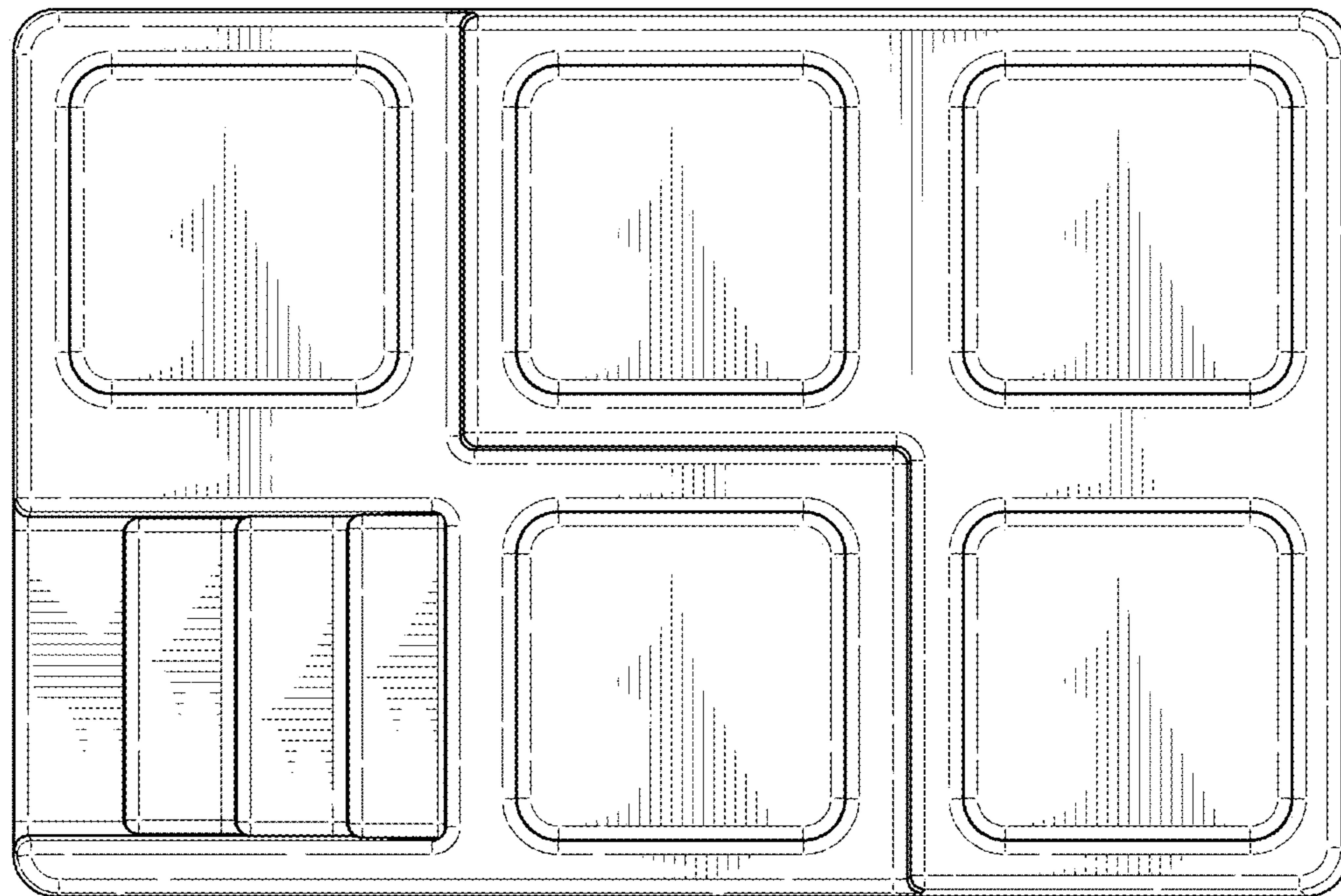




**FIG. 18**

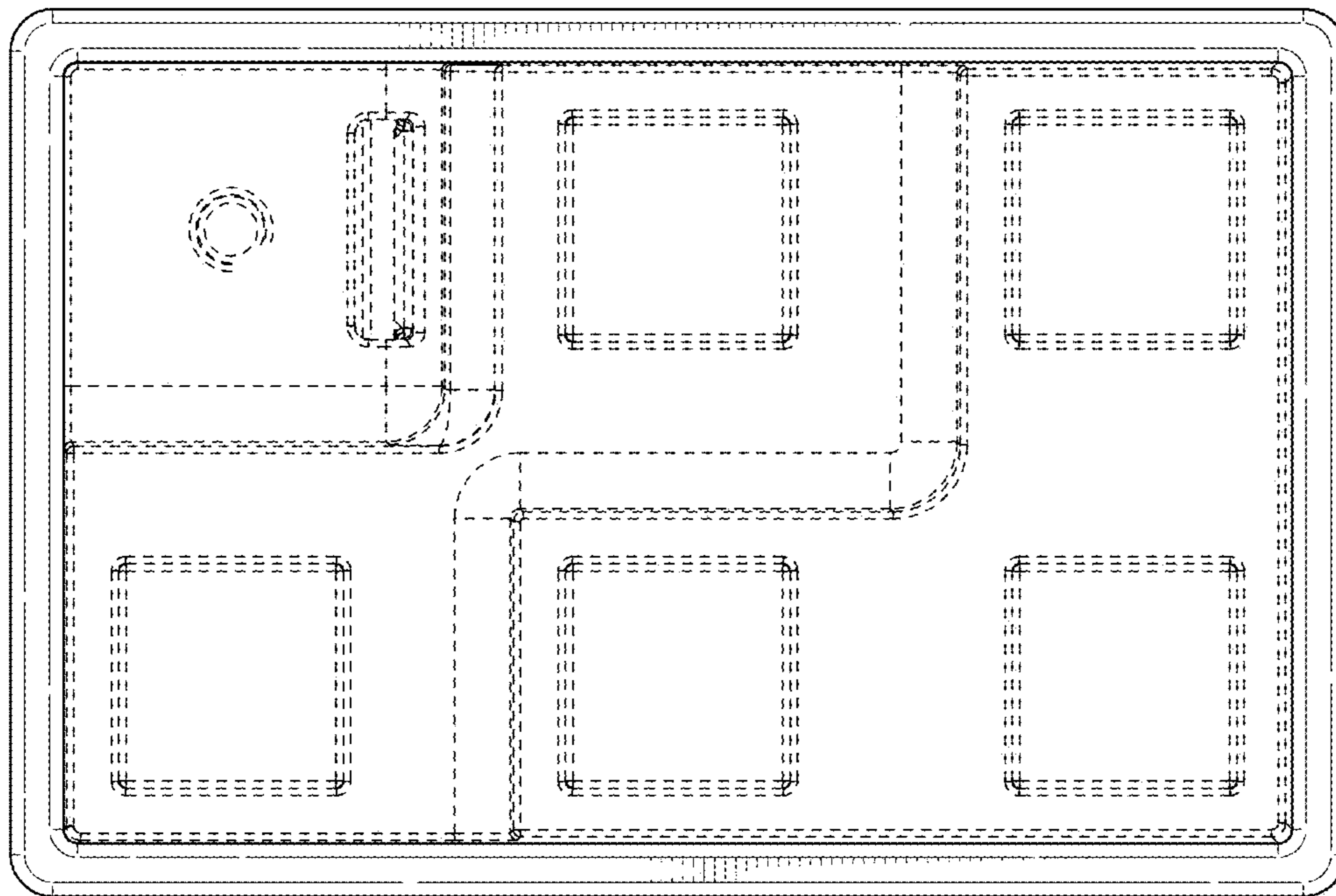


**FIG. 19**

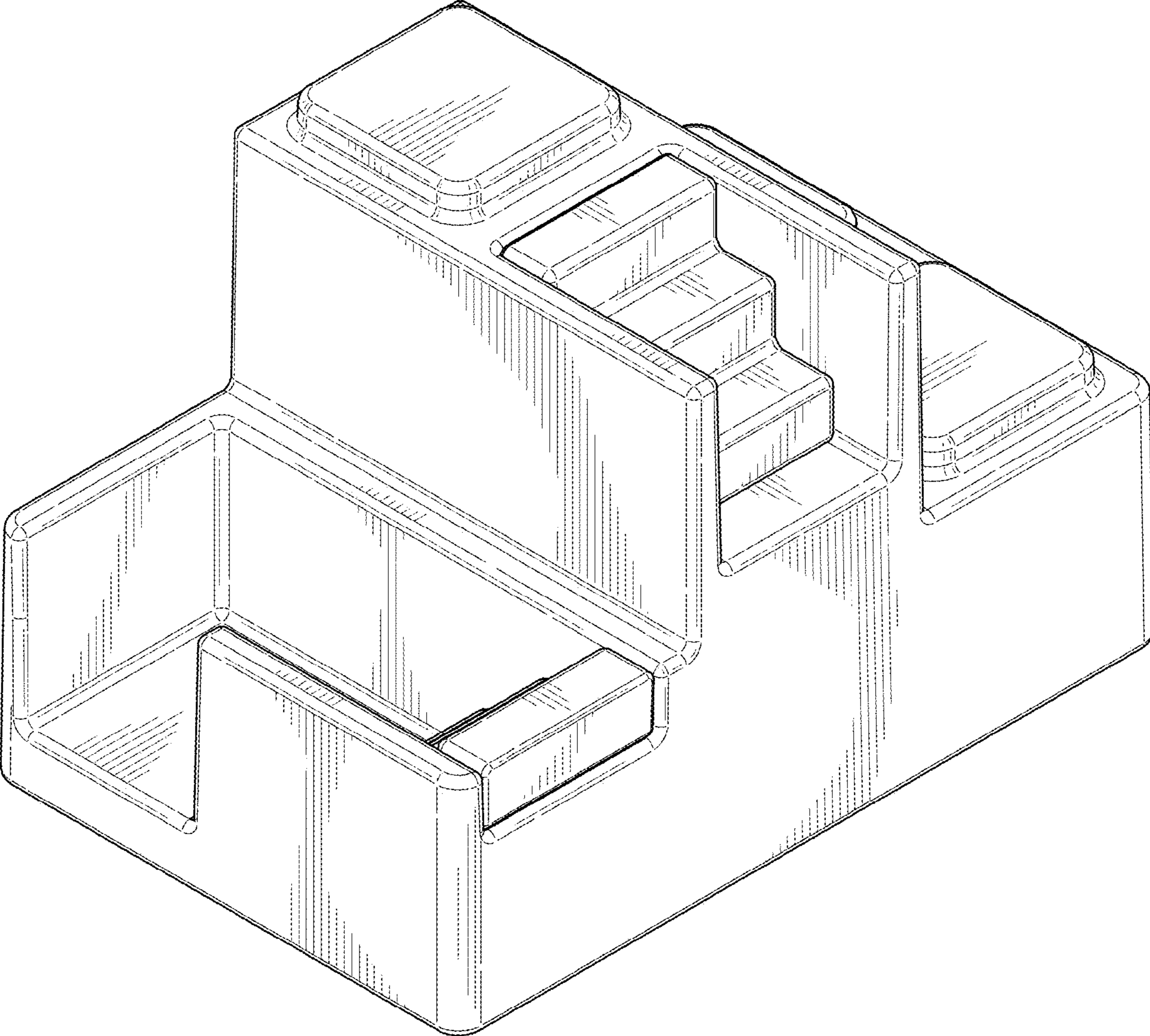


**FIG. 20**





**FIG. 21**



**FIG. 22**



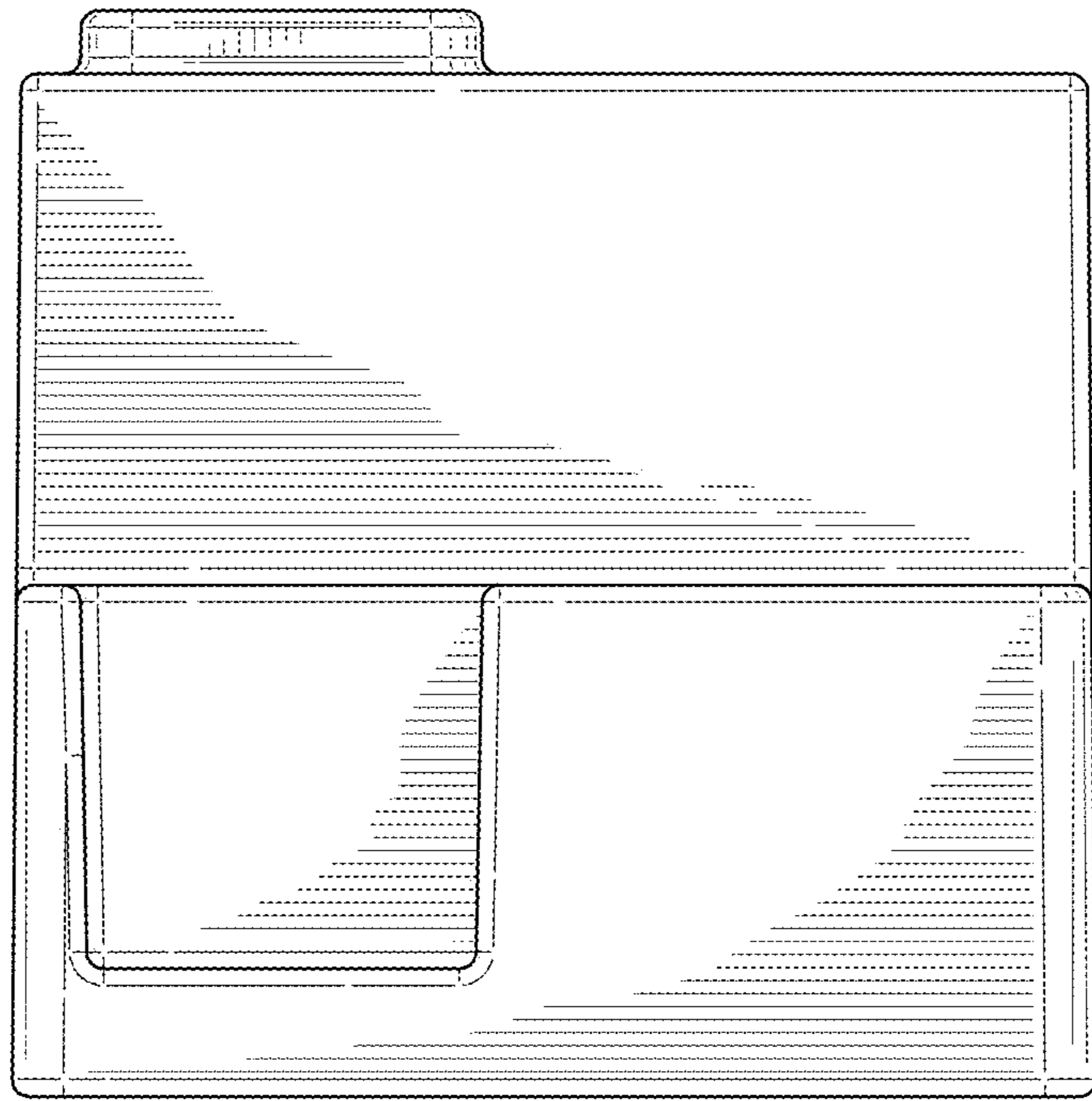


FIG. 23

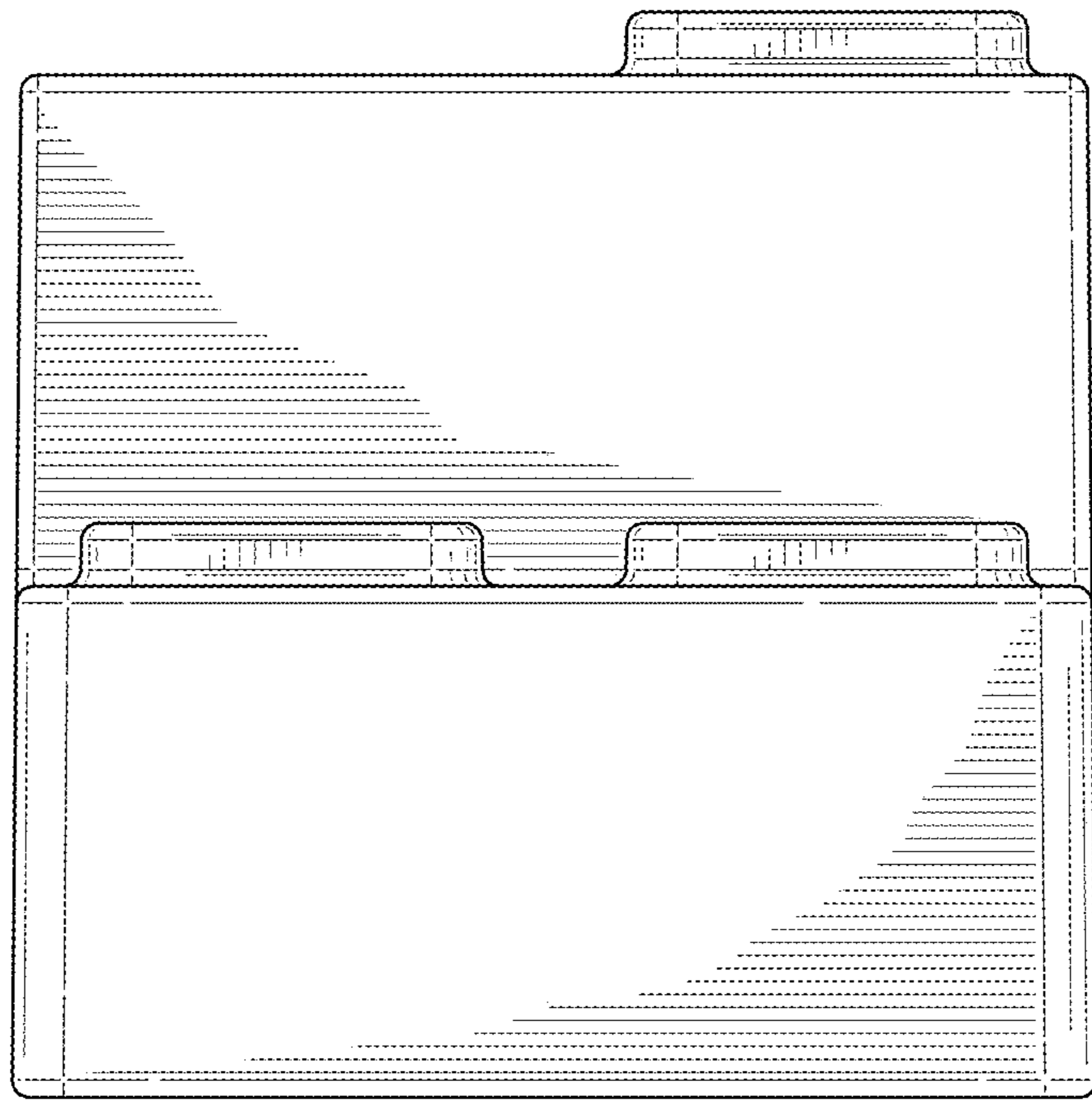
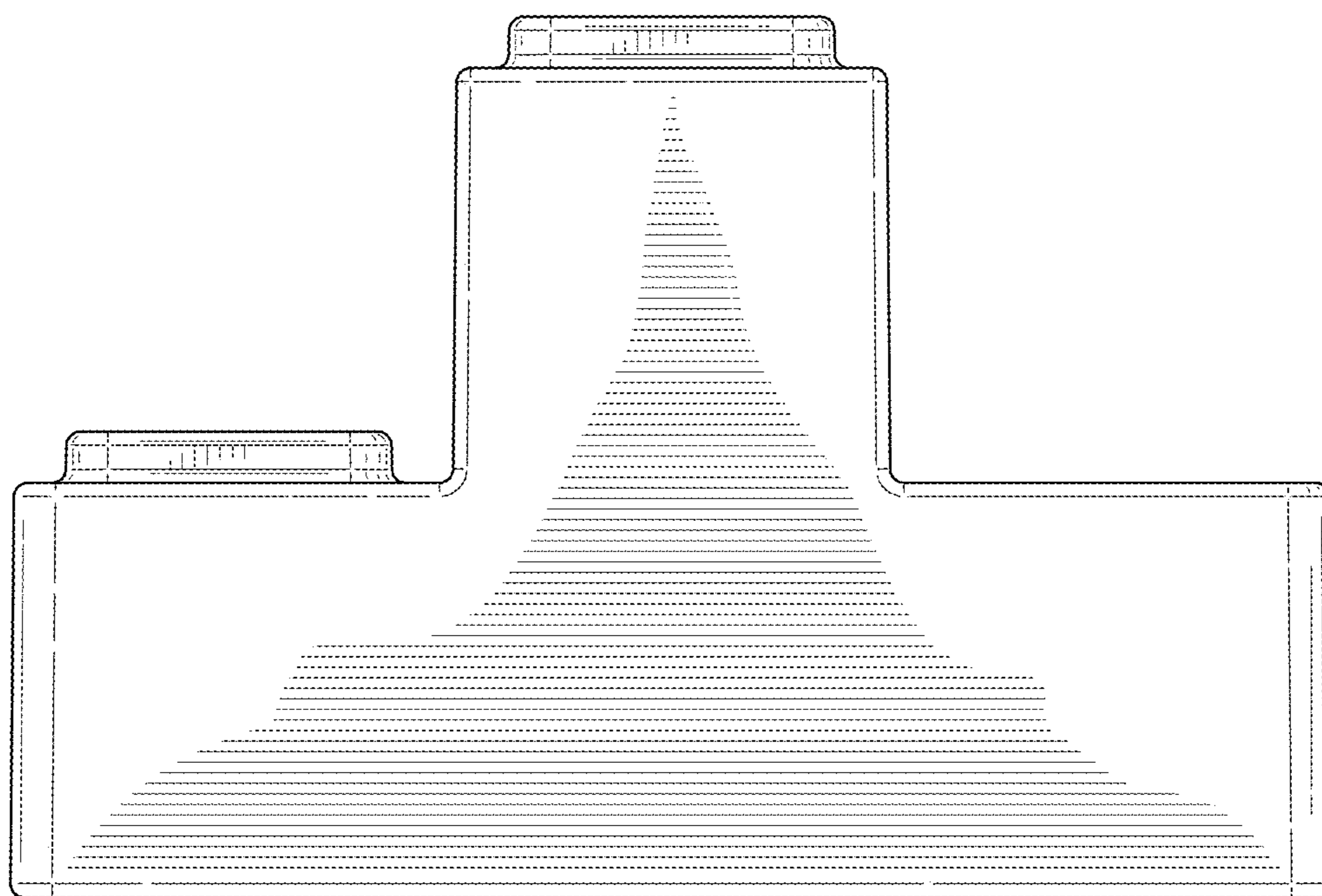
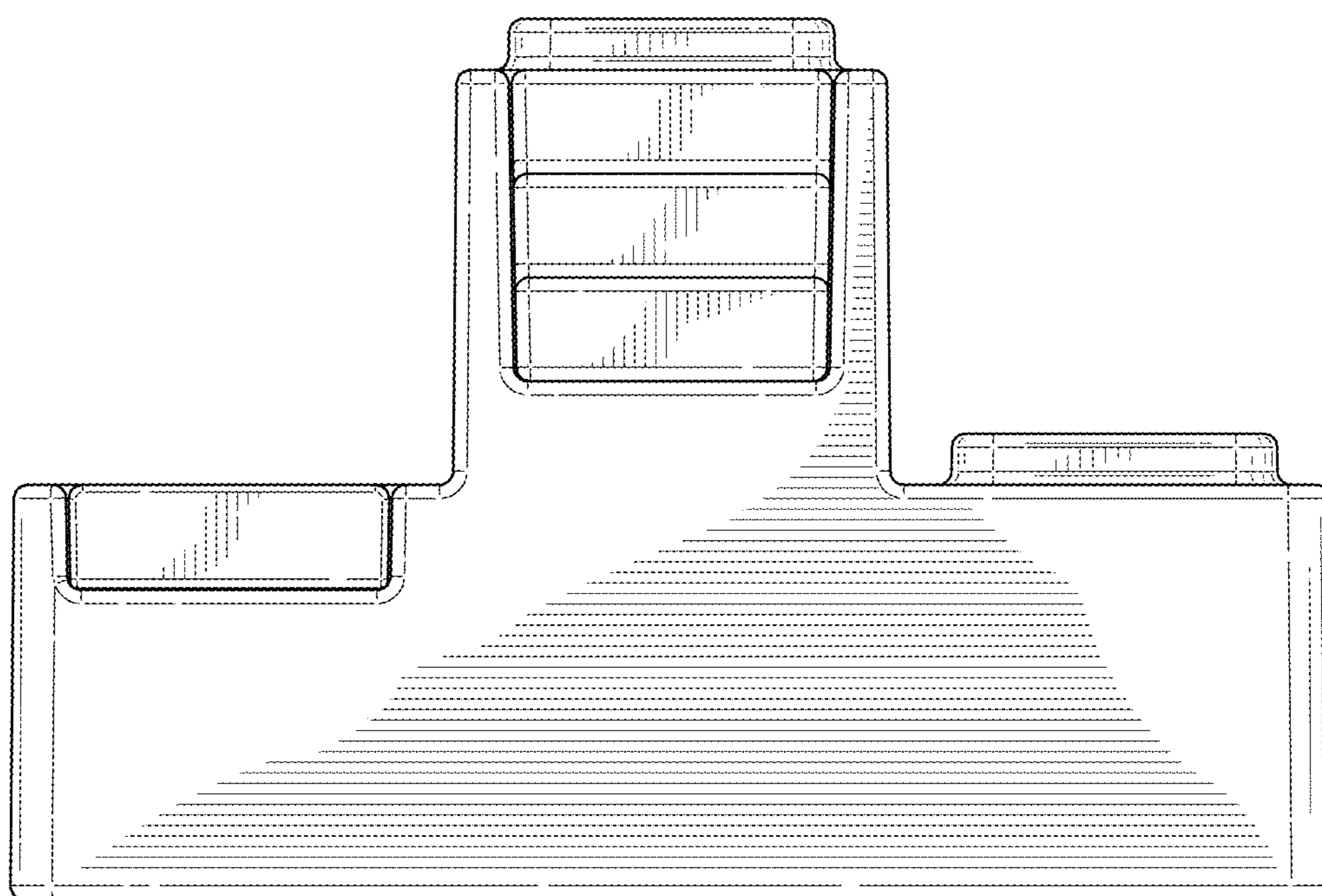


FIG. 24

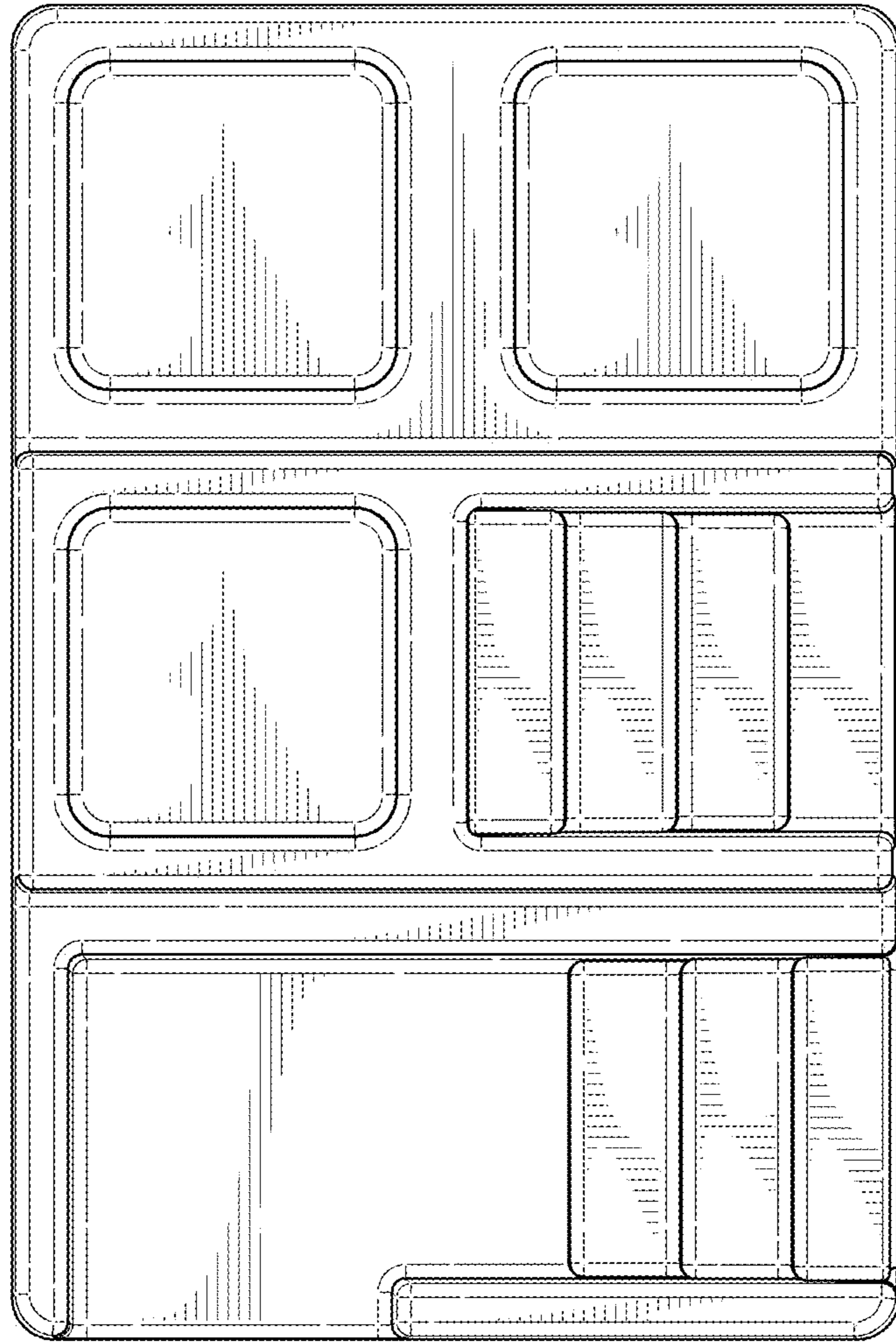


**FIG. 25**



**FIG. 26**





**FIG. 27**

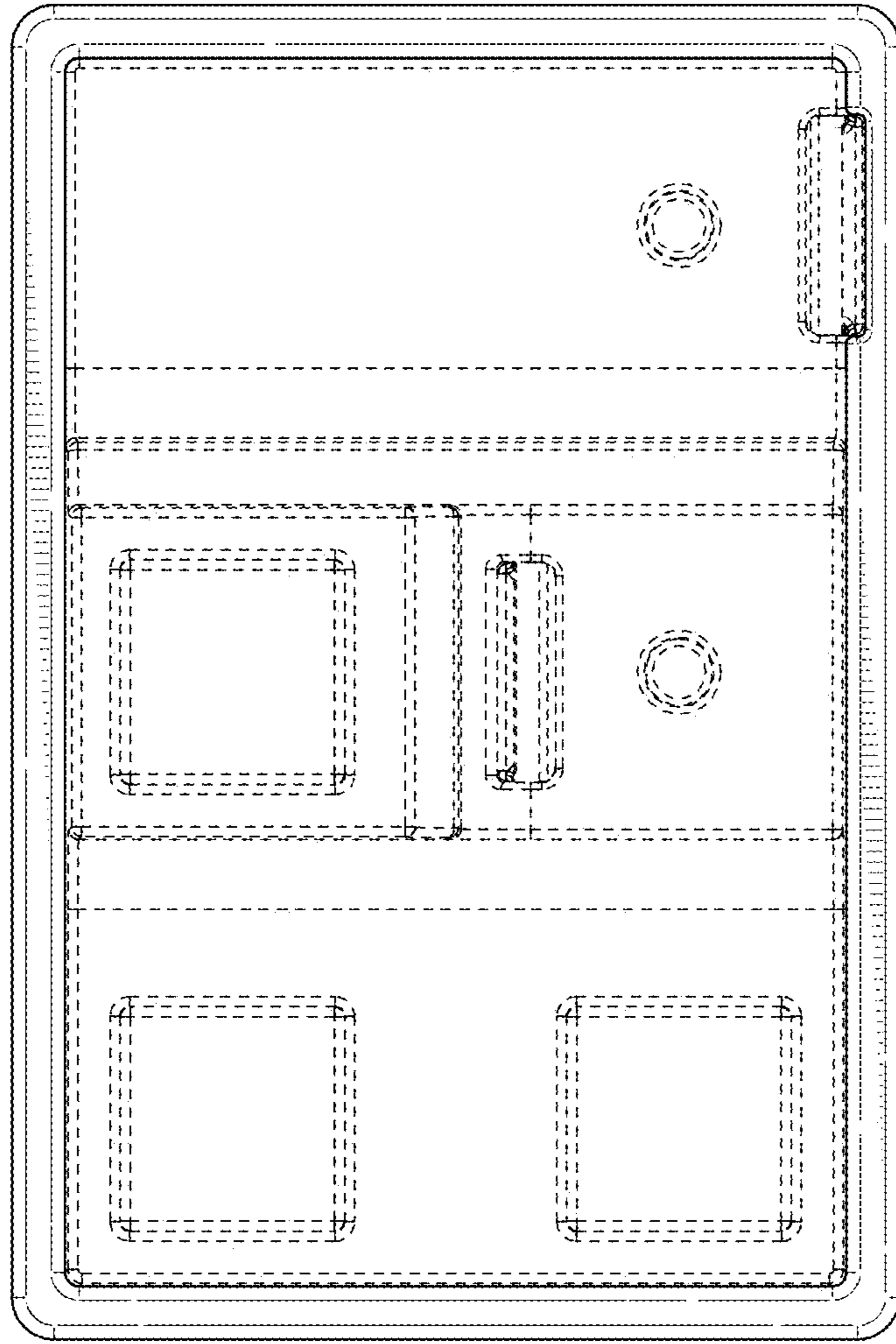
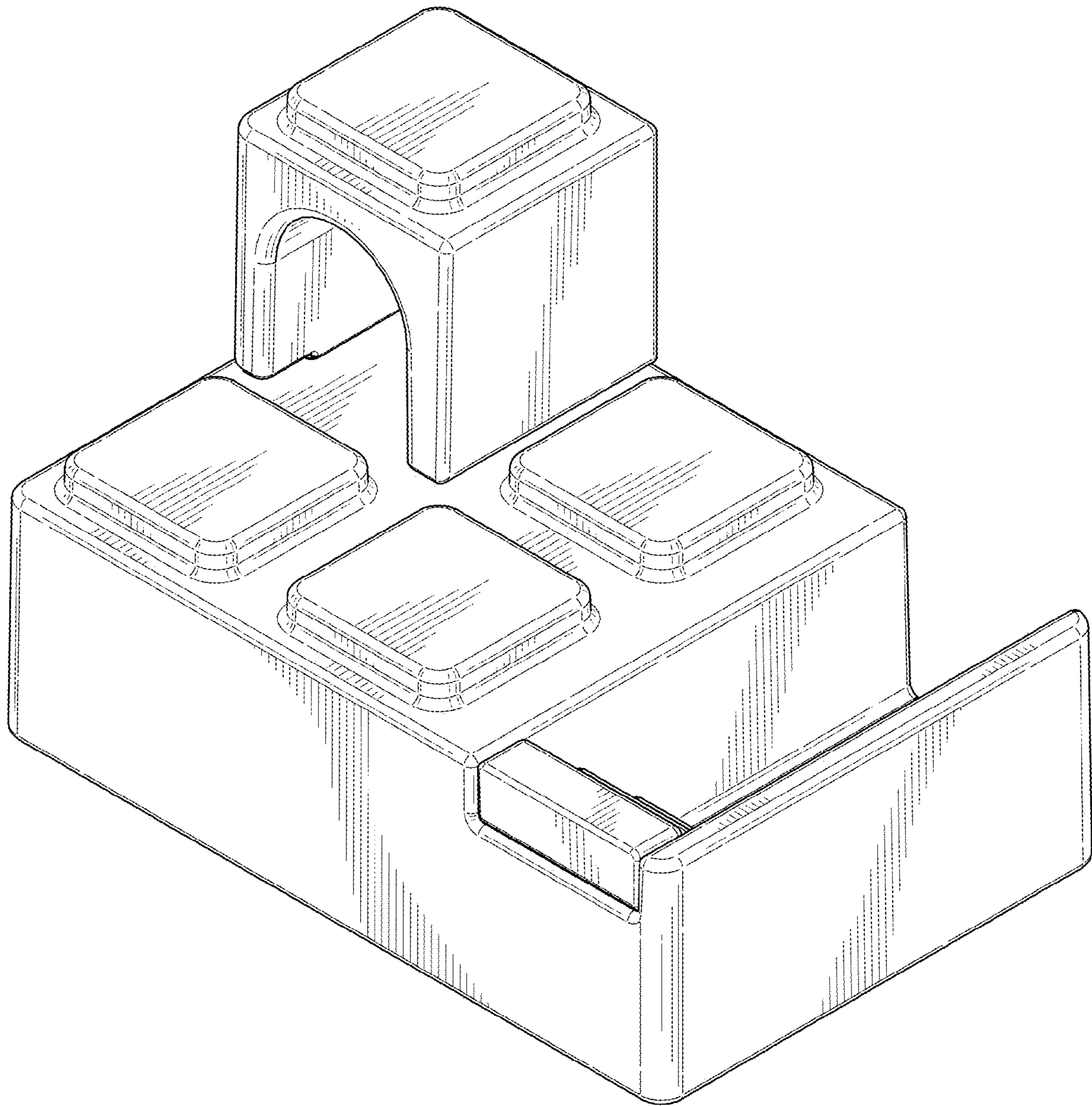
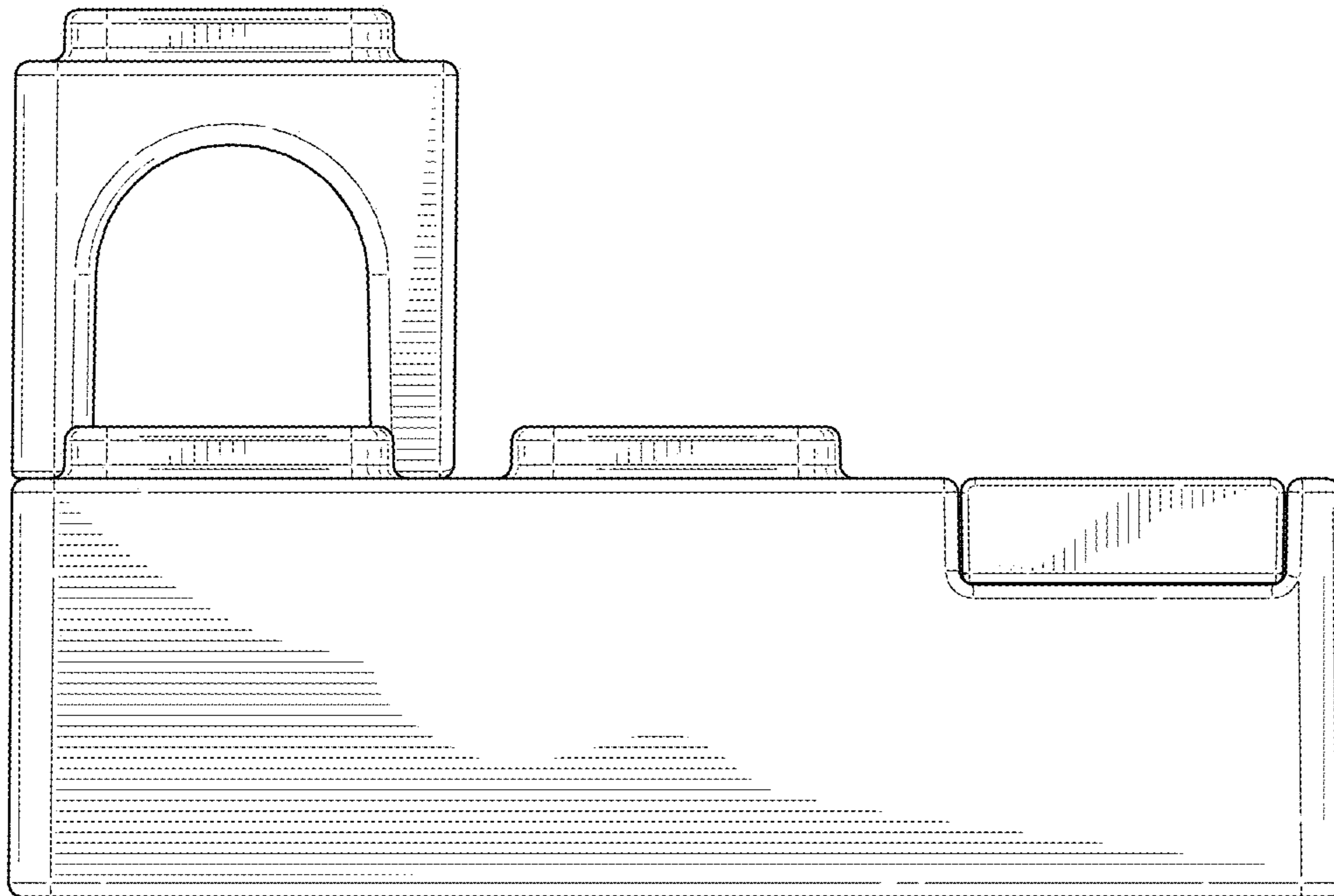


FIG. 28

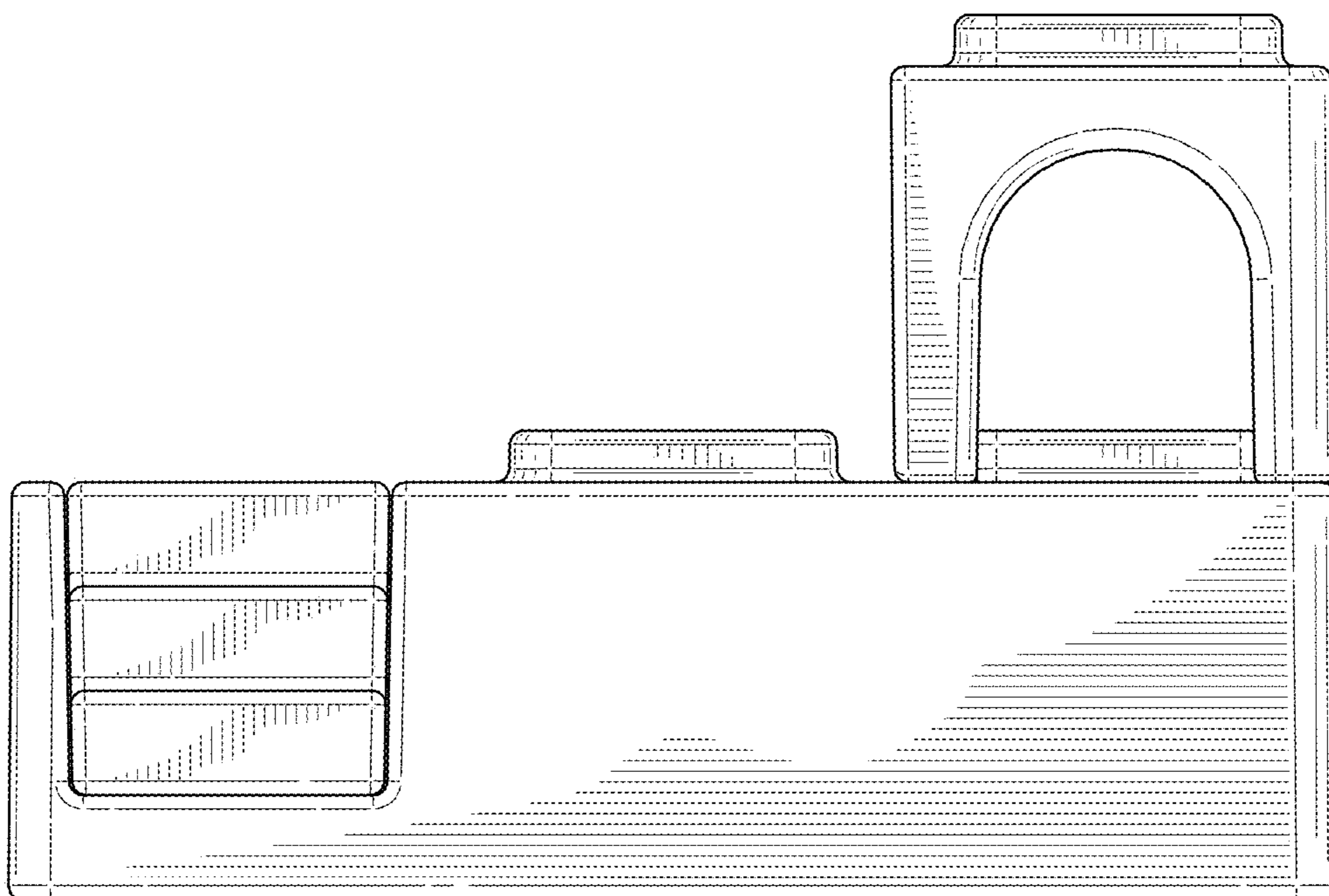


**FIG. 29**

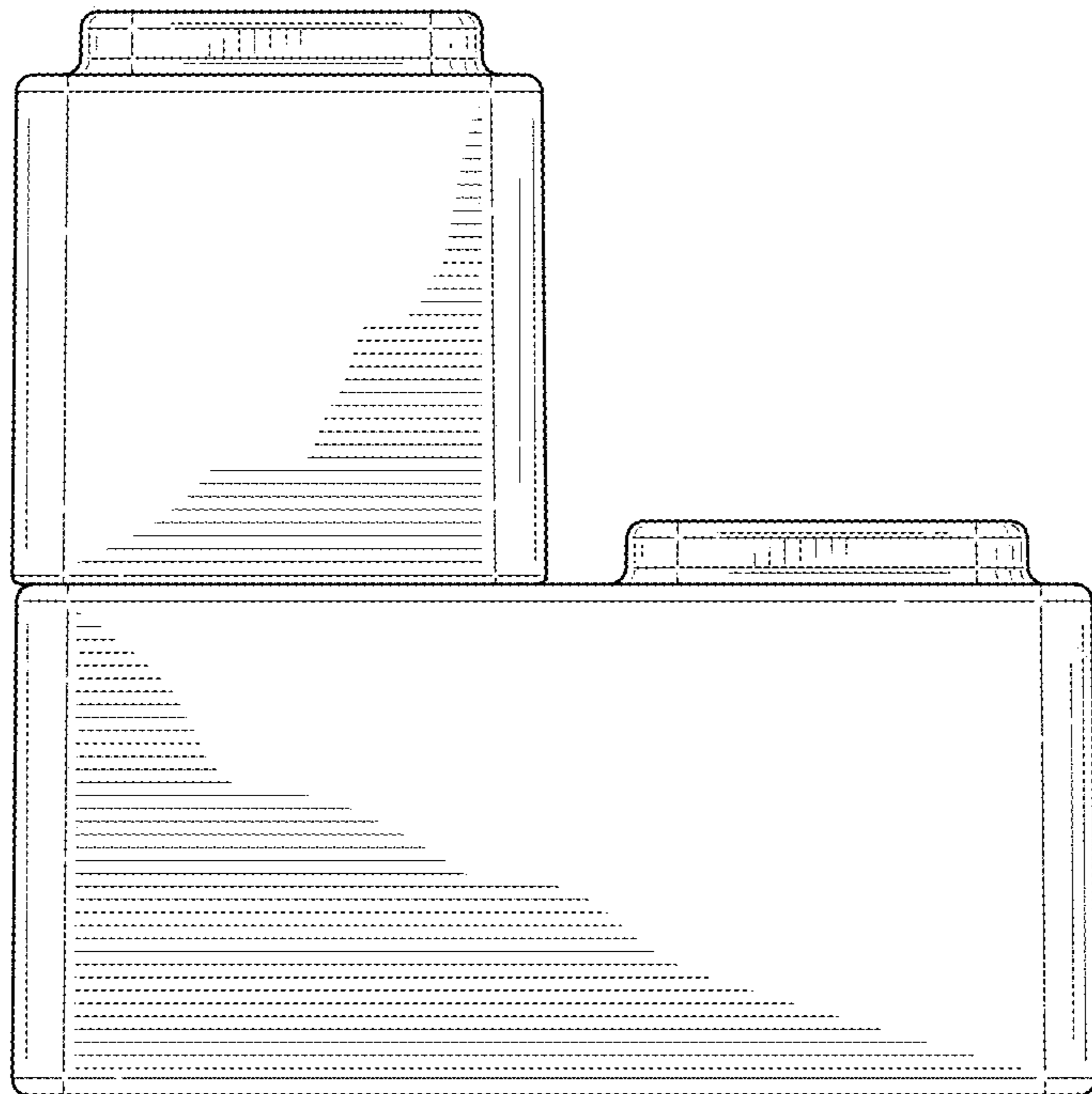




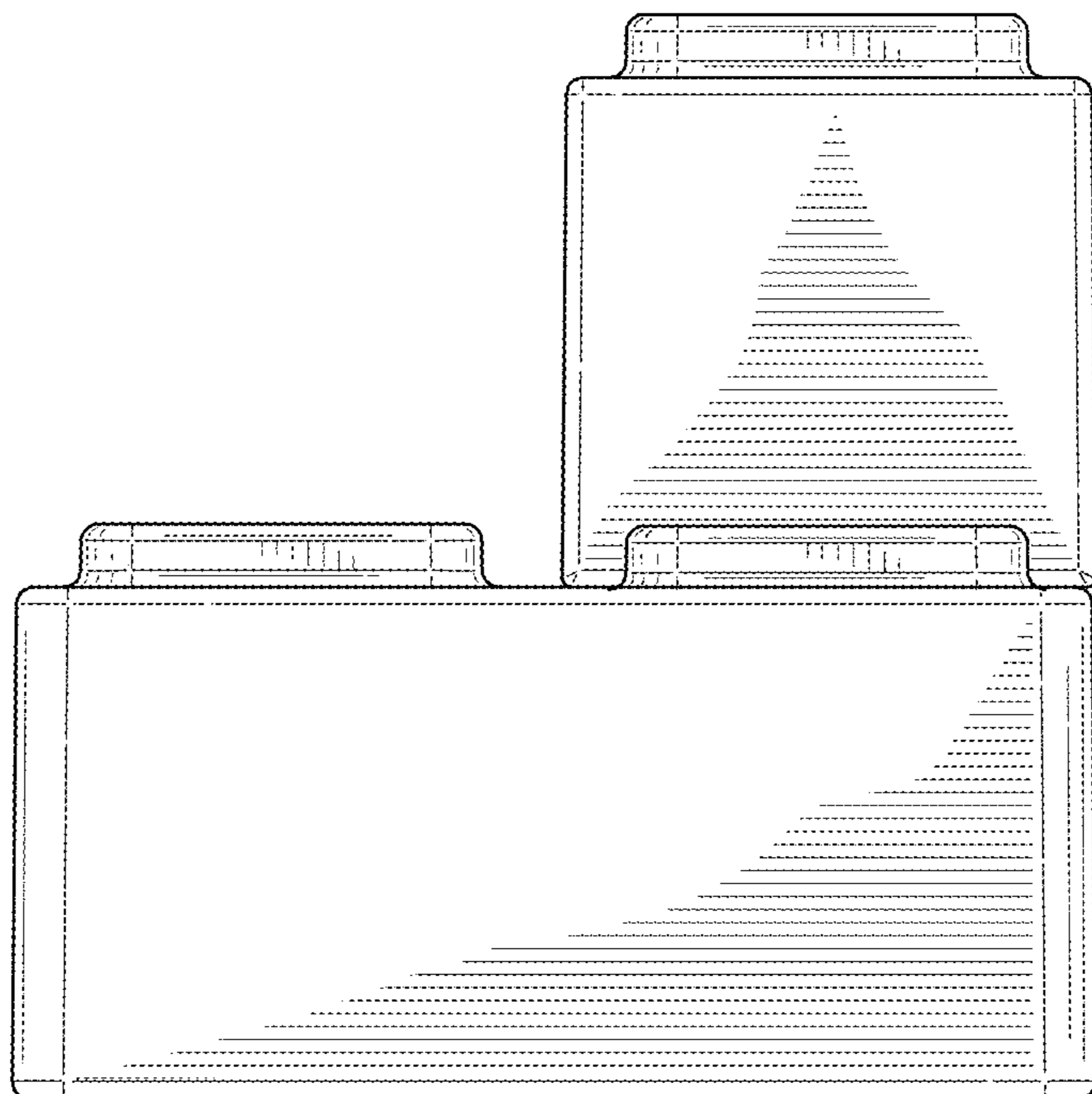
**FIG. 30**



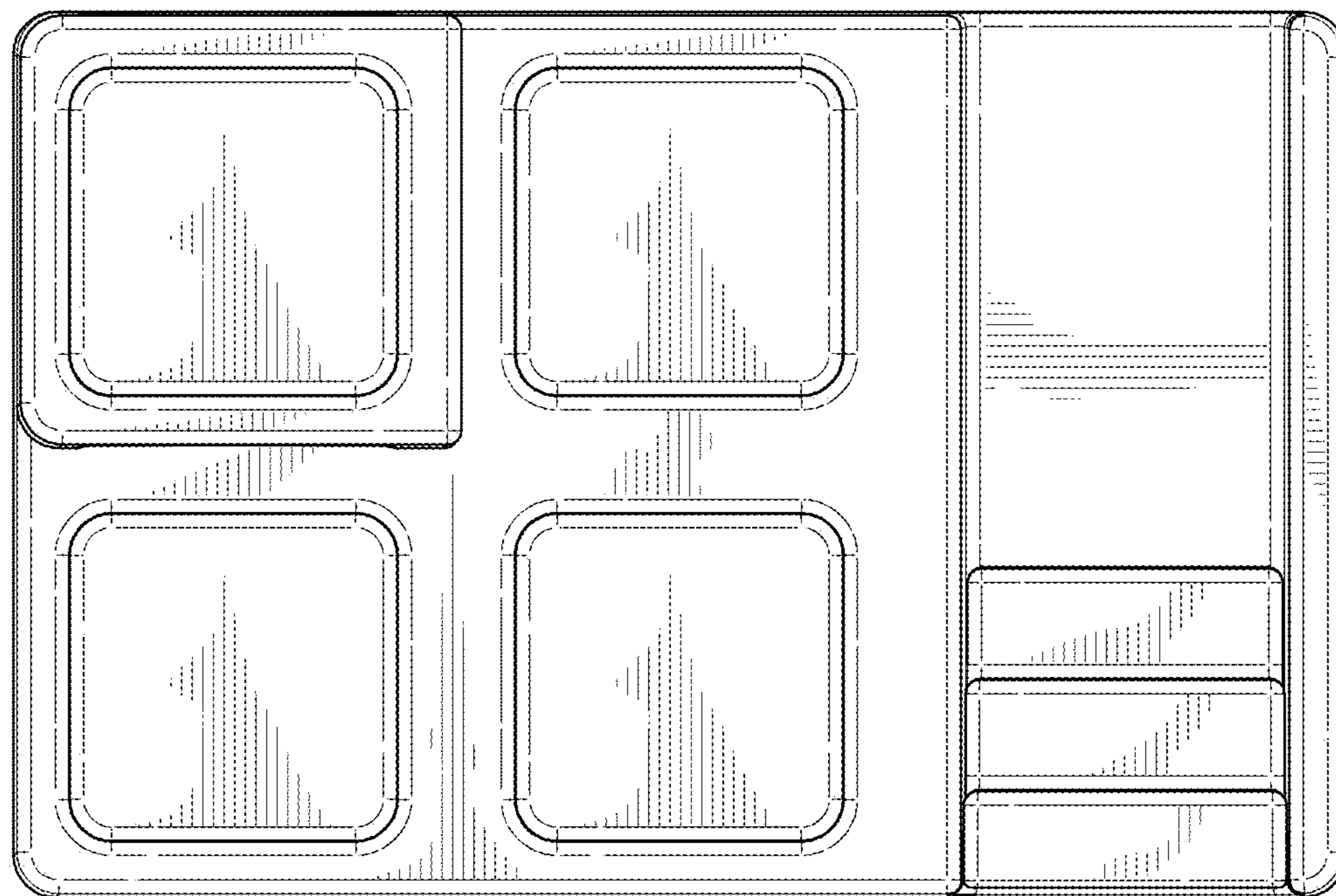
**FIG. 31**



**FIG. 32**



**FIG. 33**



**FIG. 34**



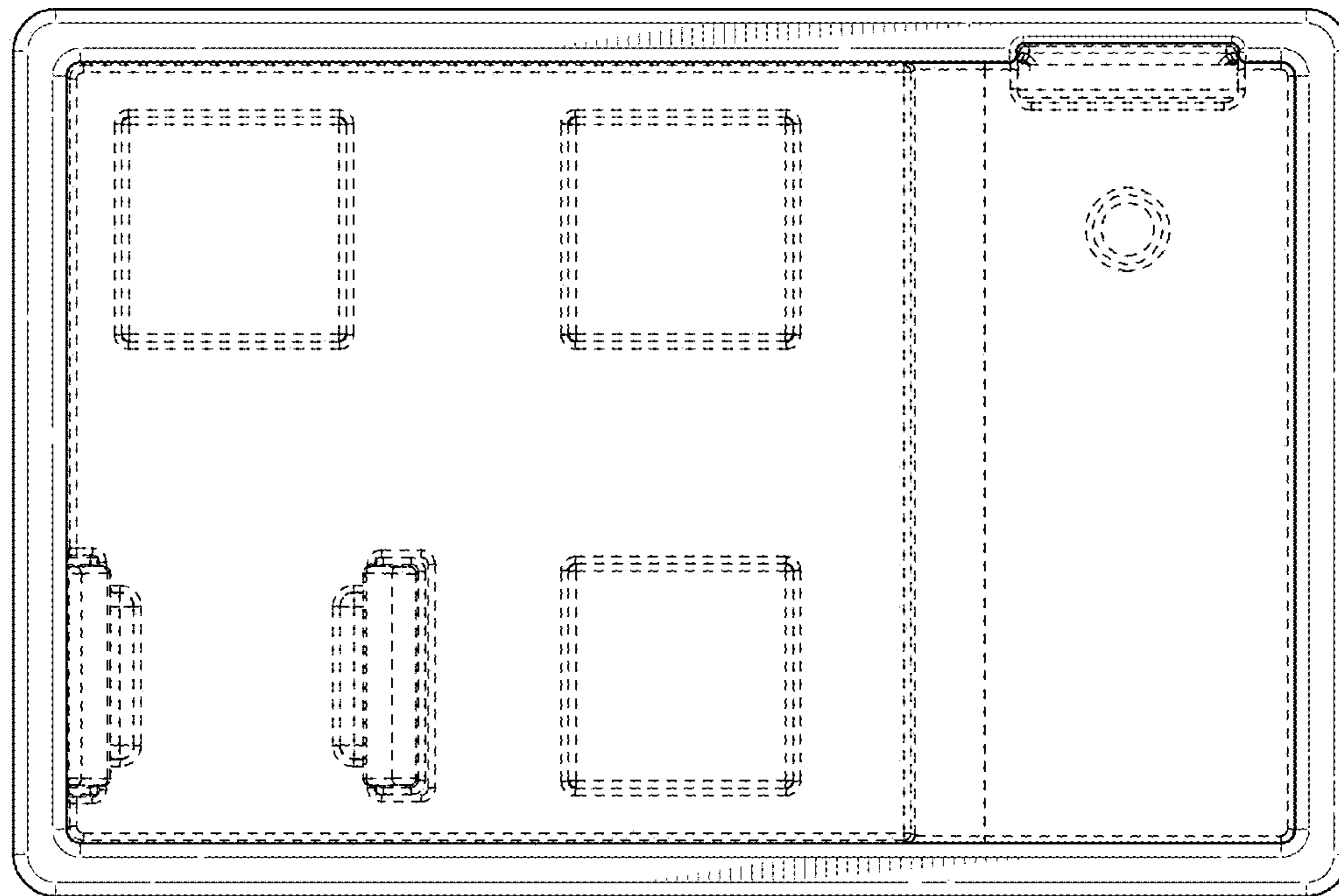
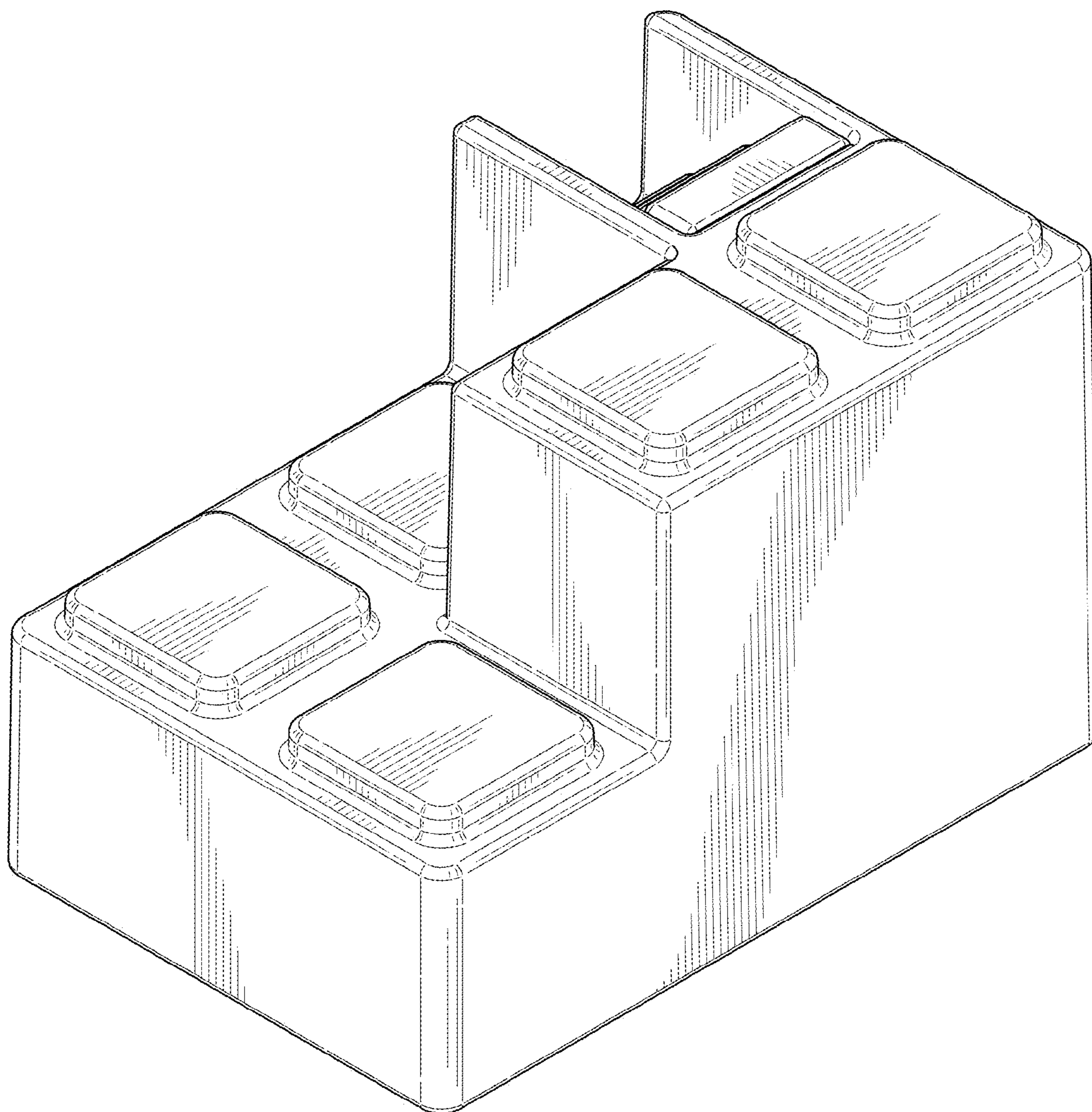
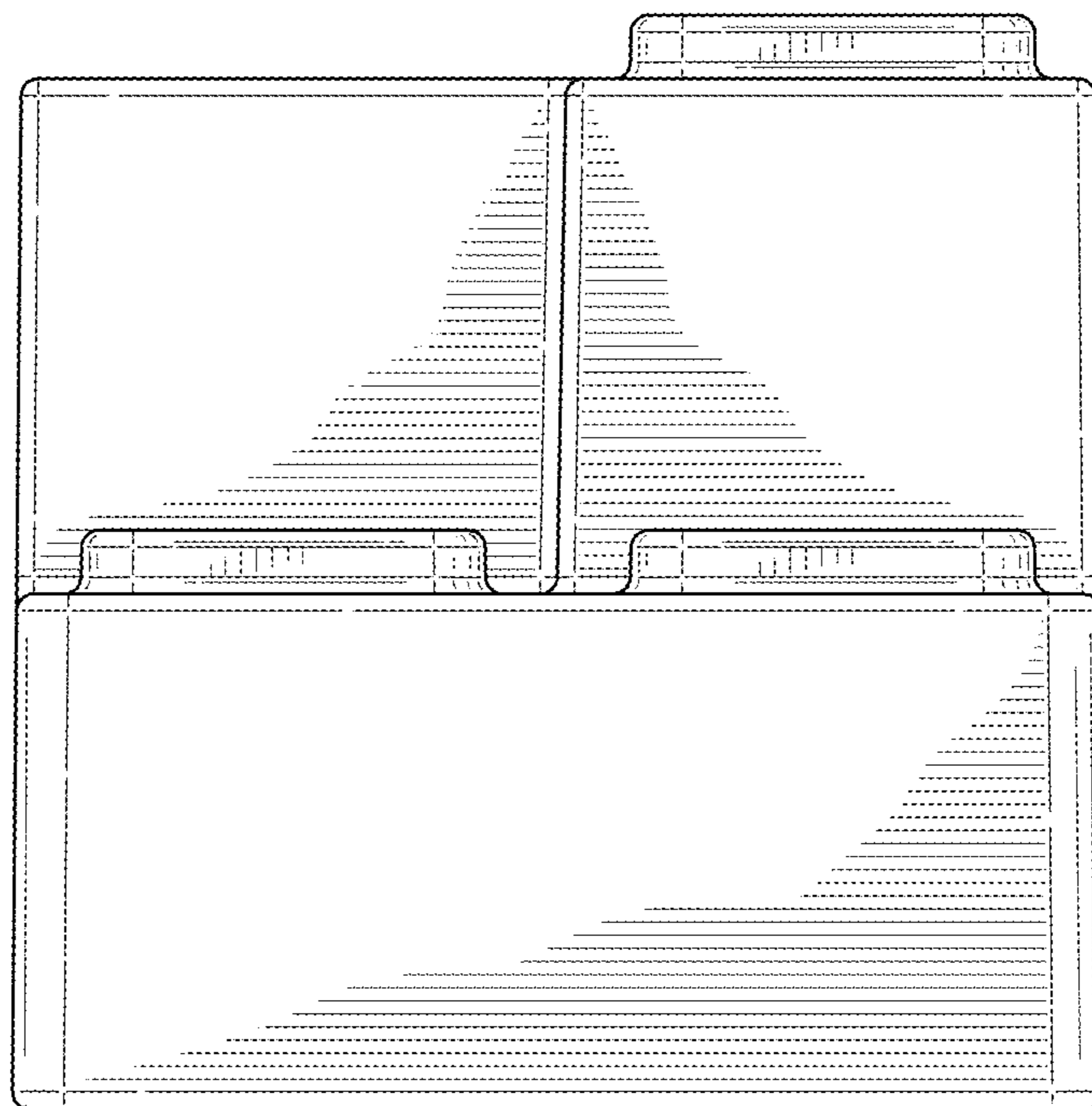


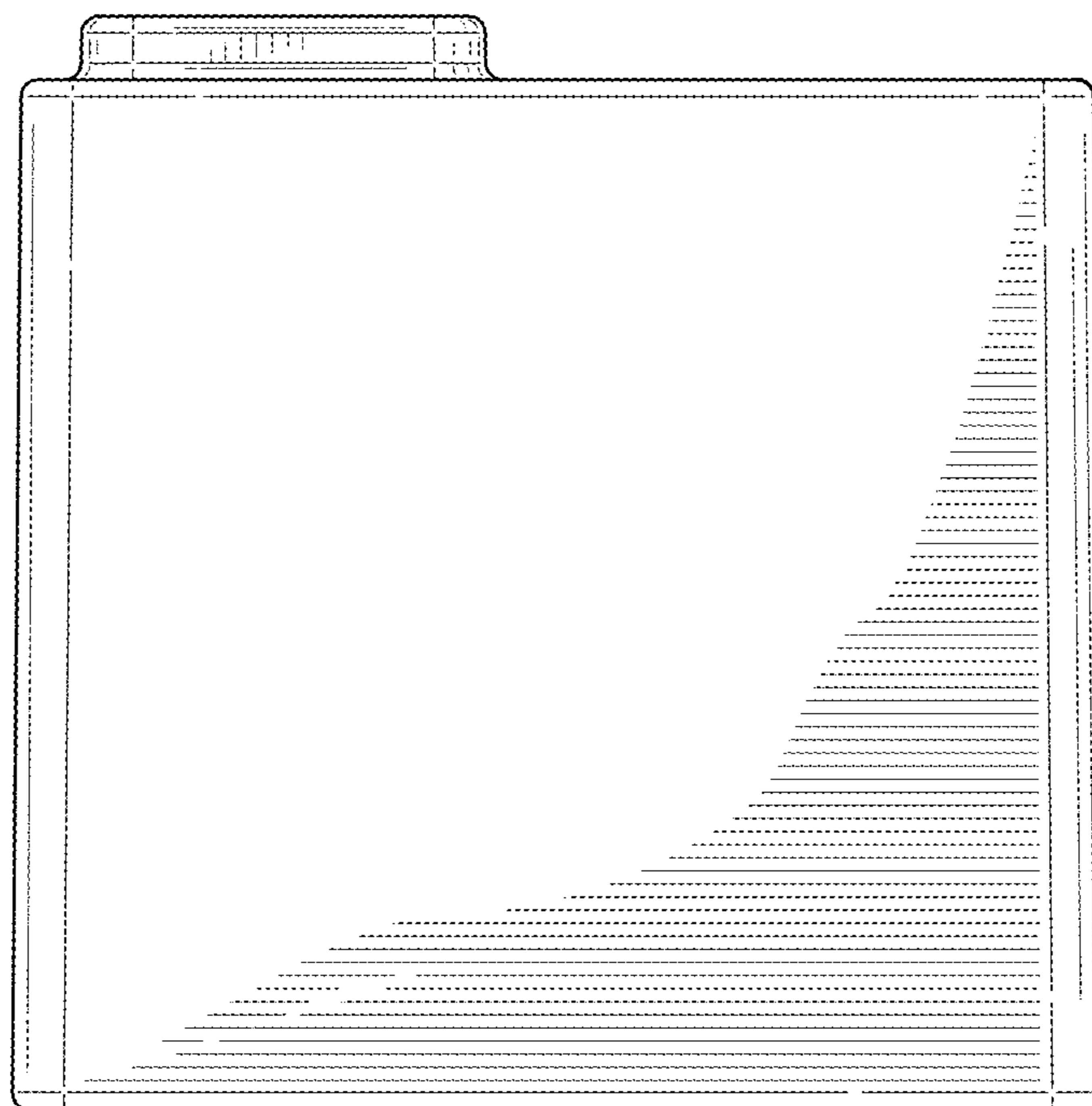
FIG. 35



**FIG. 36**

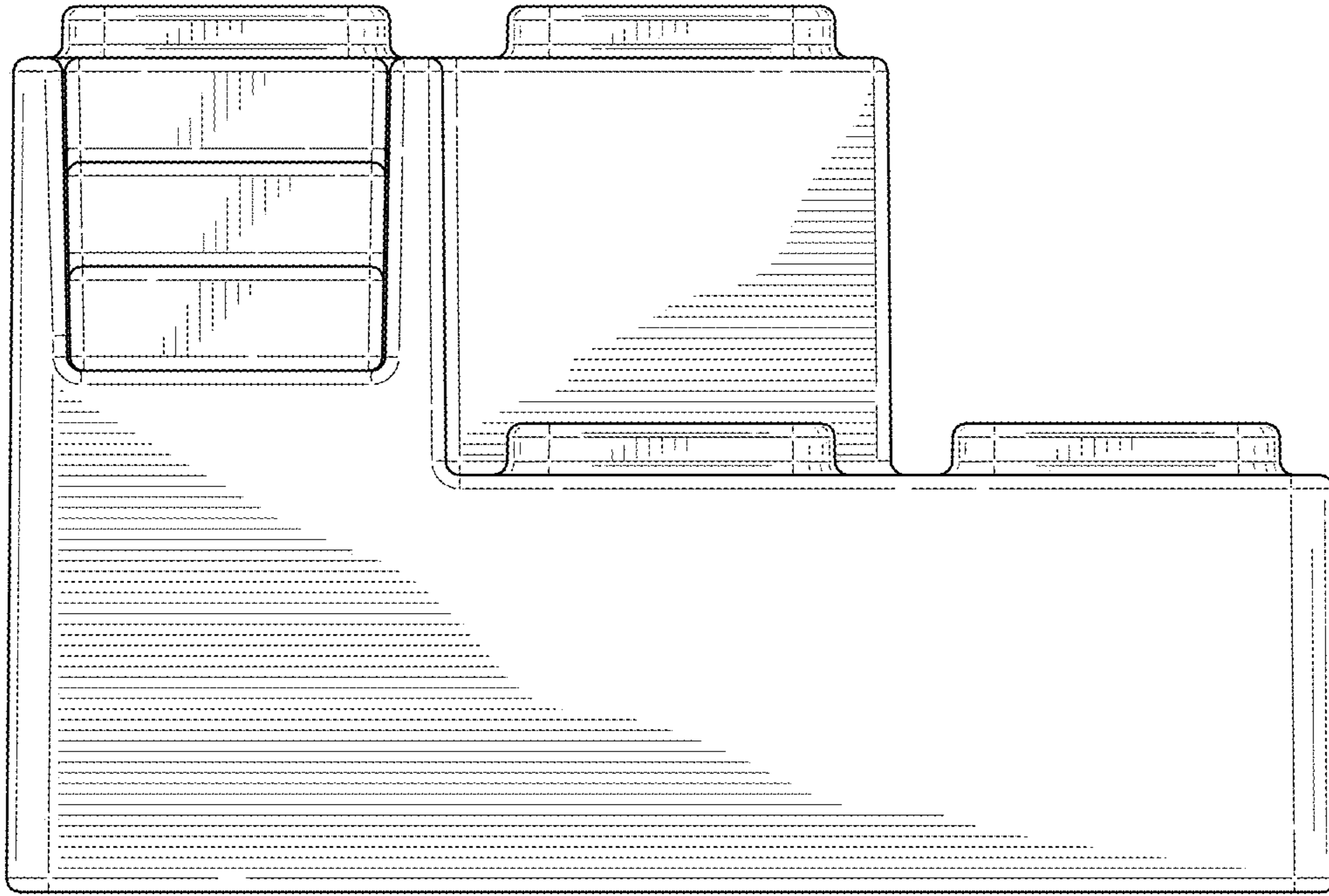


**FIG. 37**

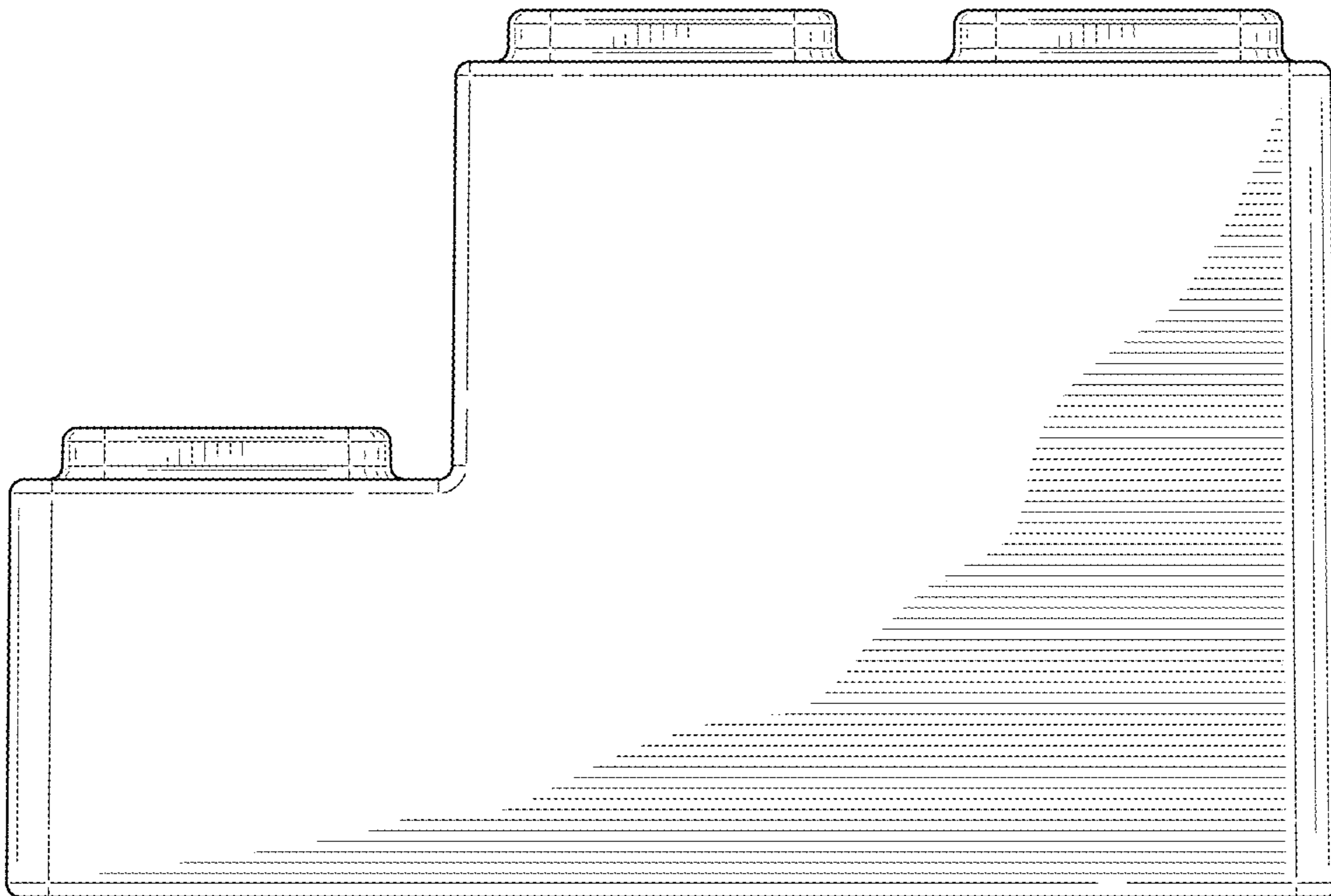


**FIG. 38**

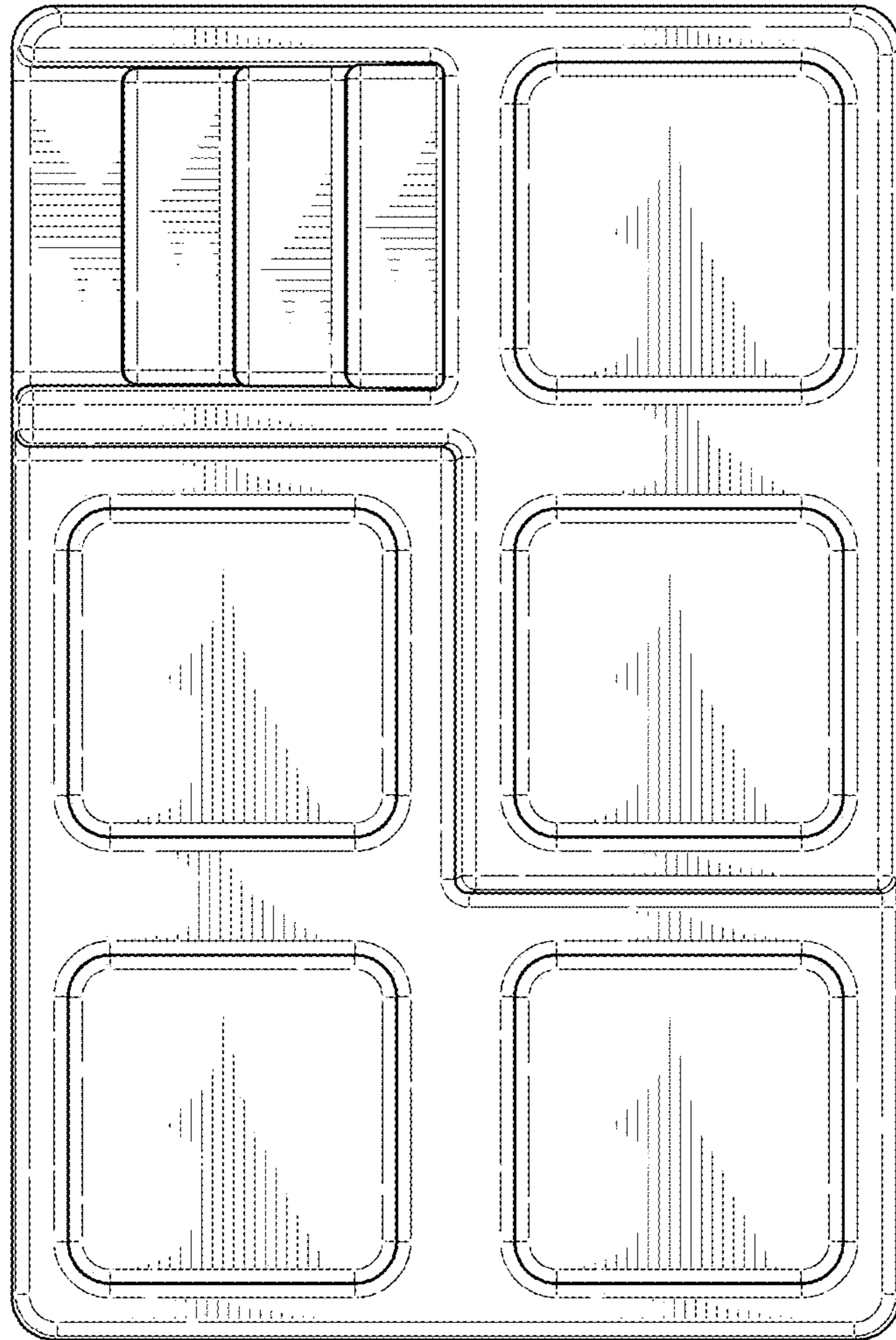




**FIG. 39**



**FIG. 40**



**FIG. 41**

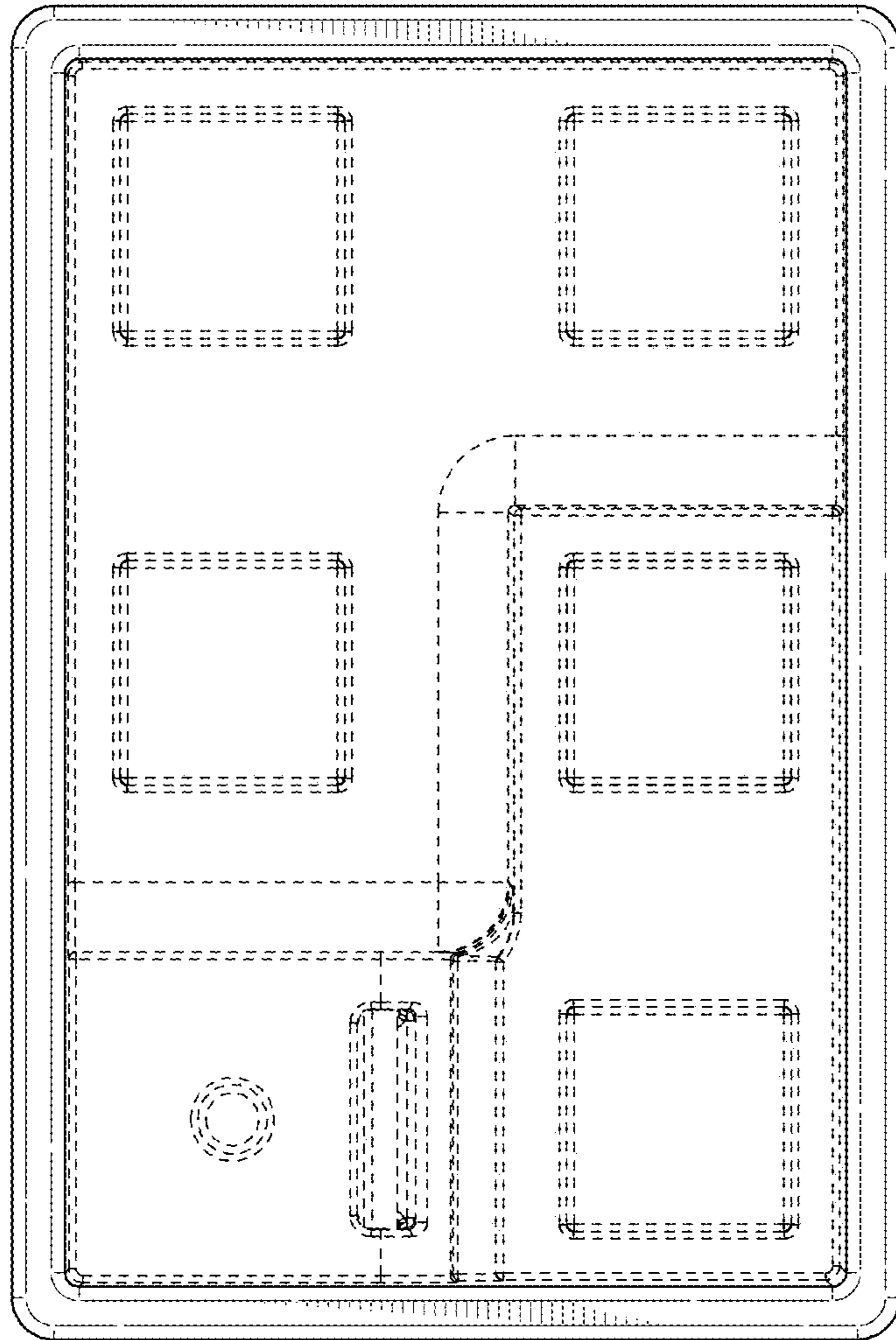
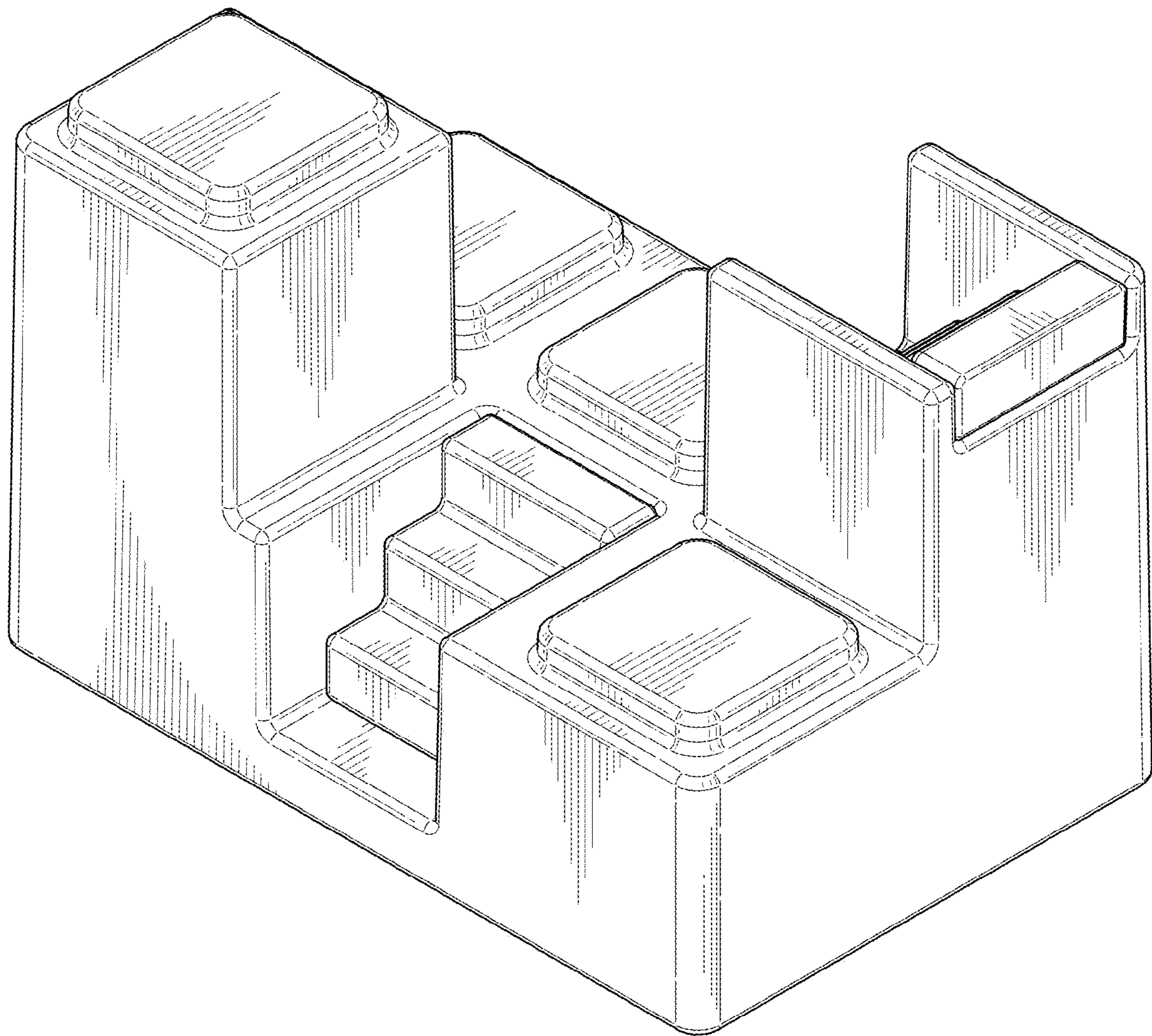
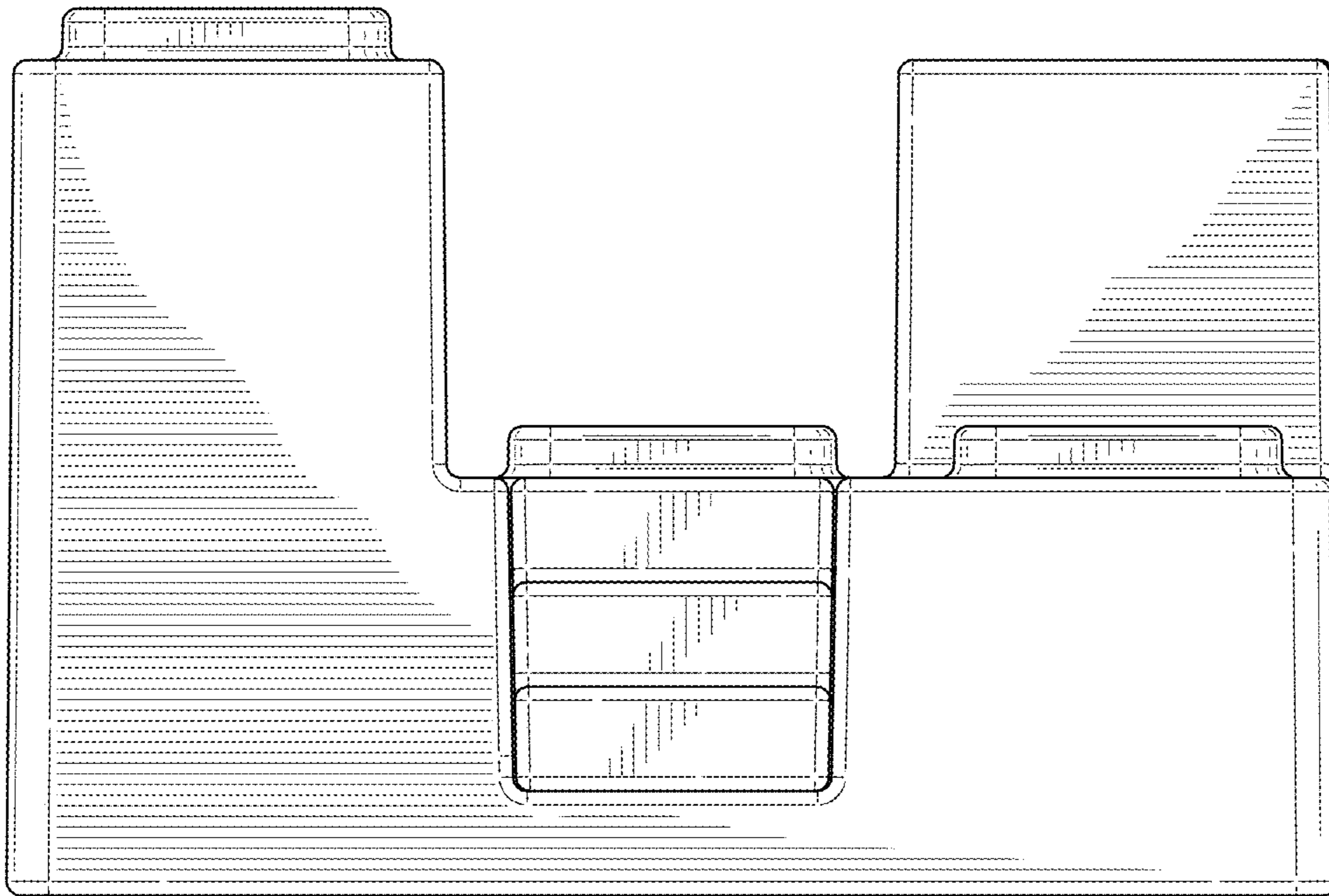


FIG. 42

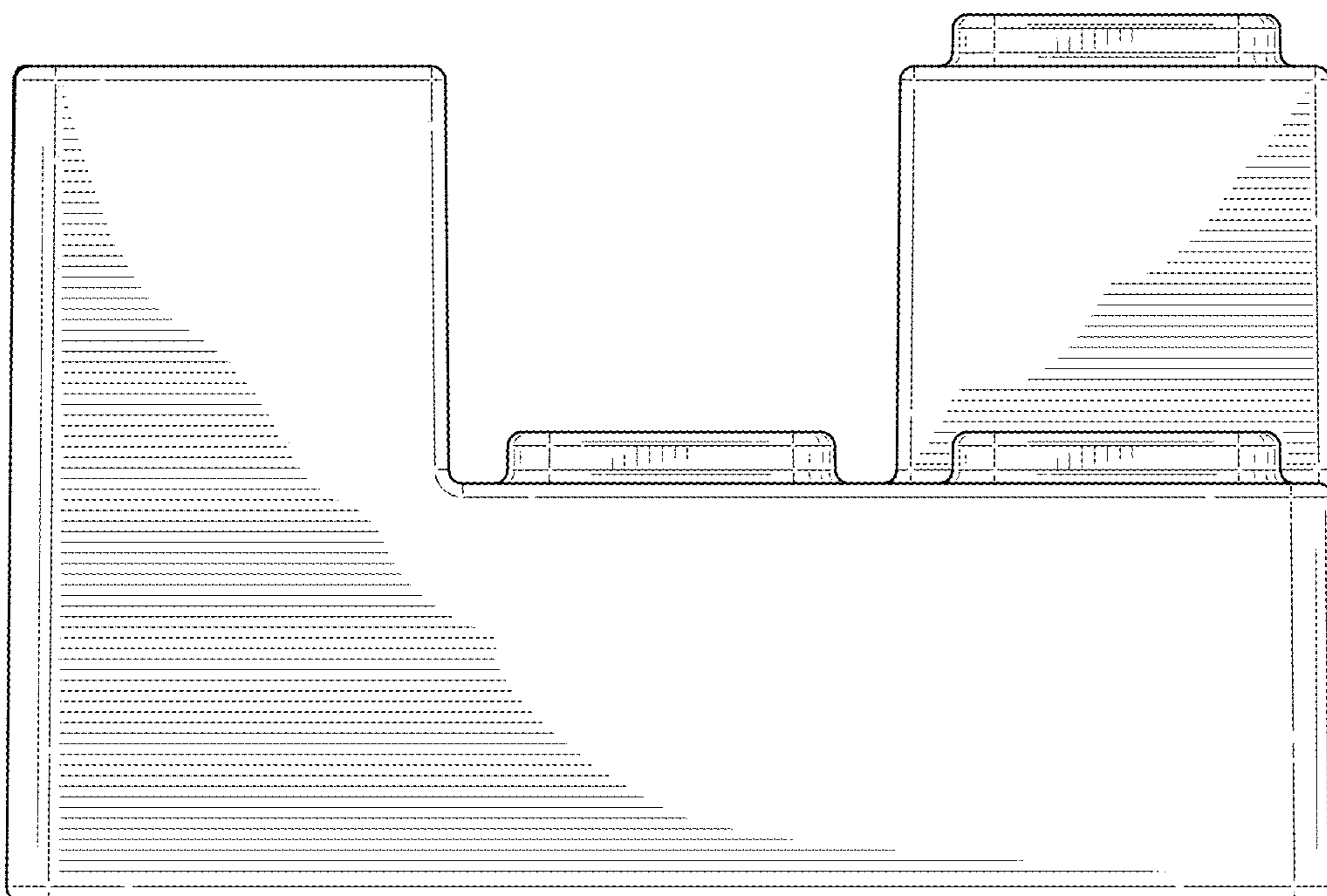




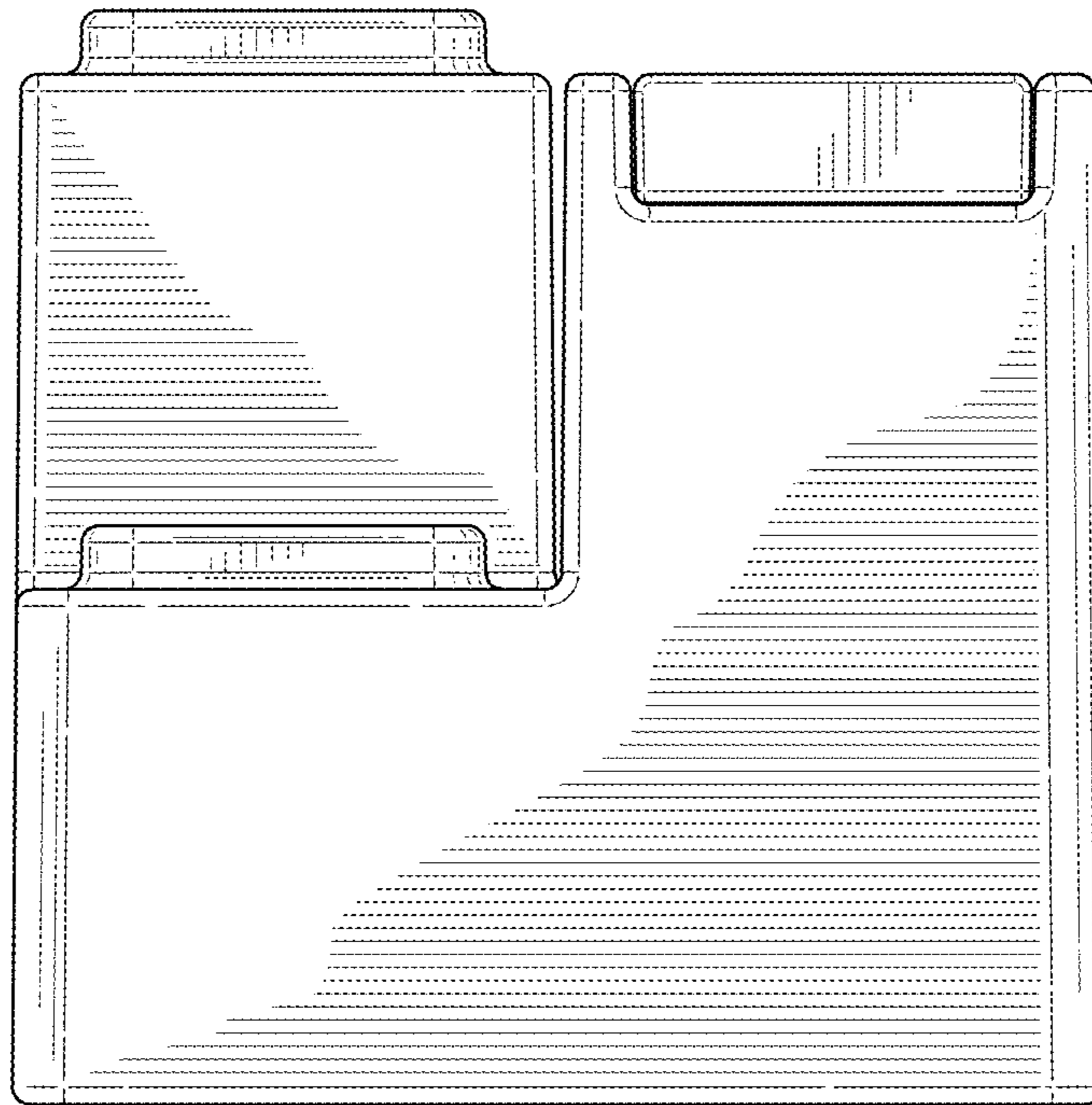
**FIG. 43**



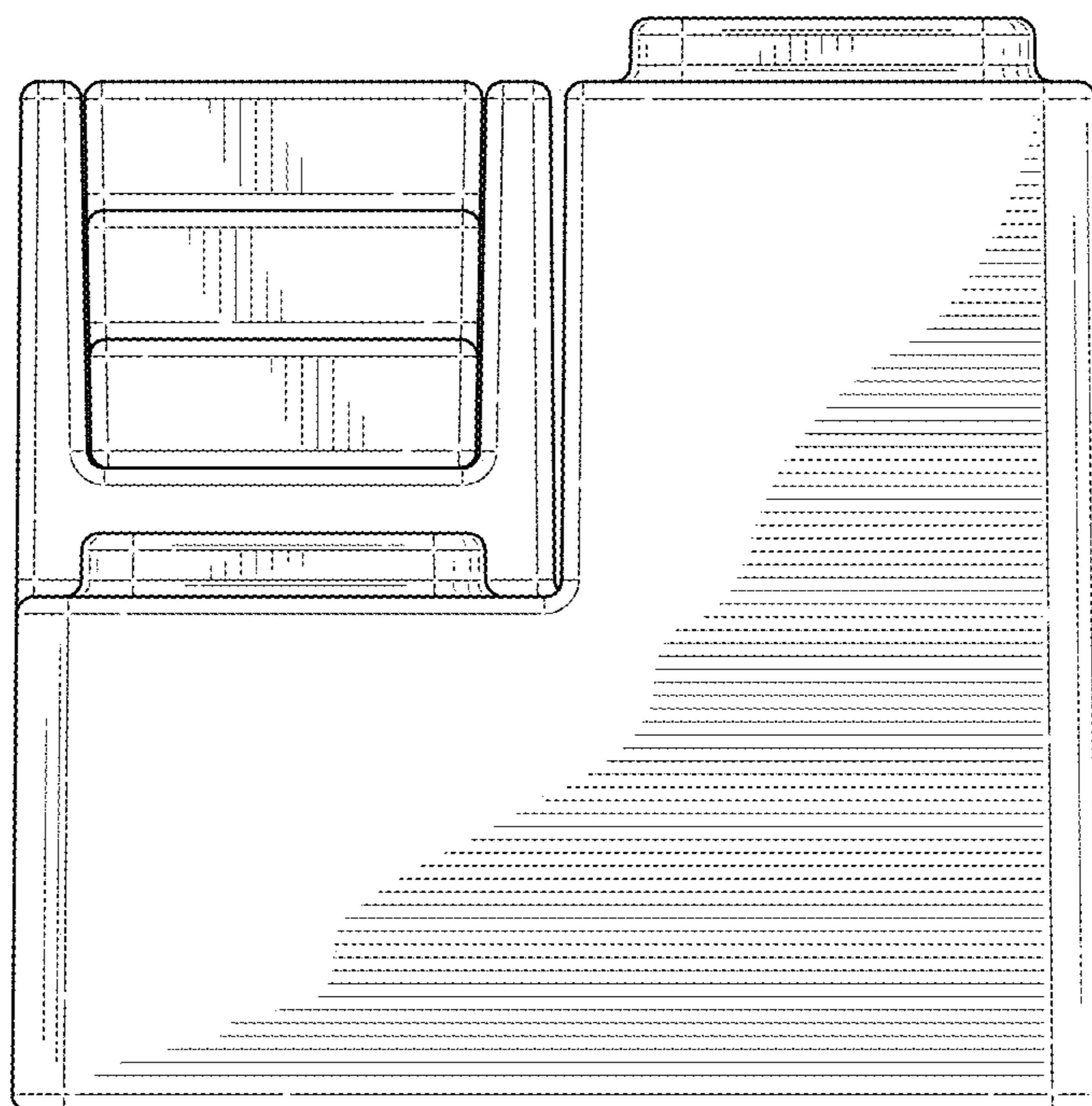
**FIG. 44**



**FIG. 45**

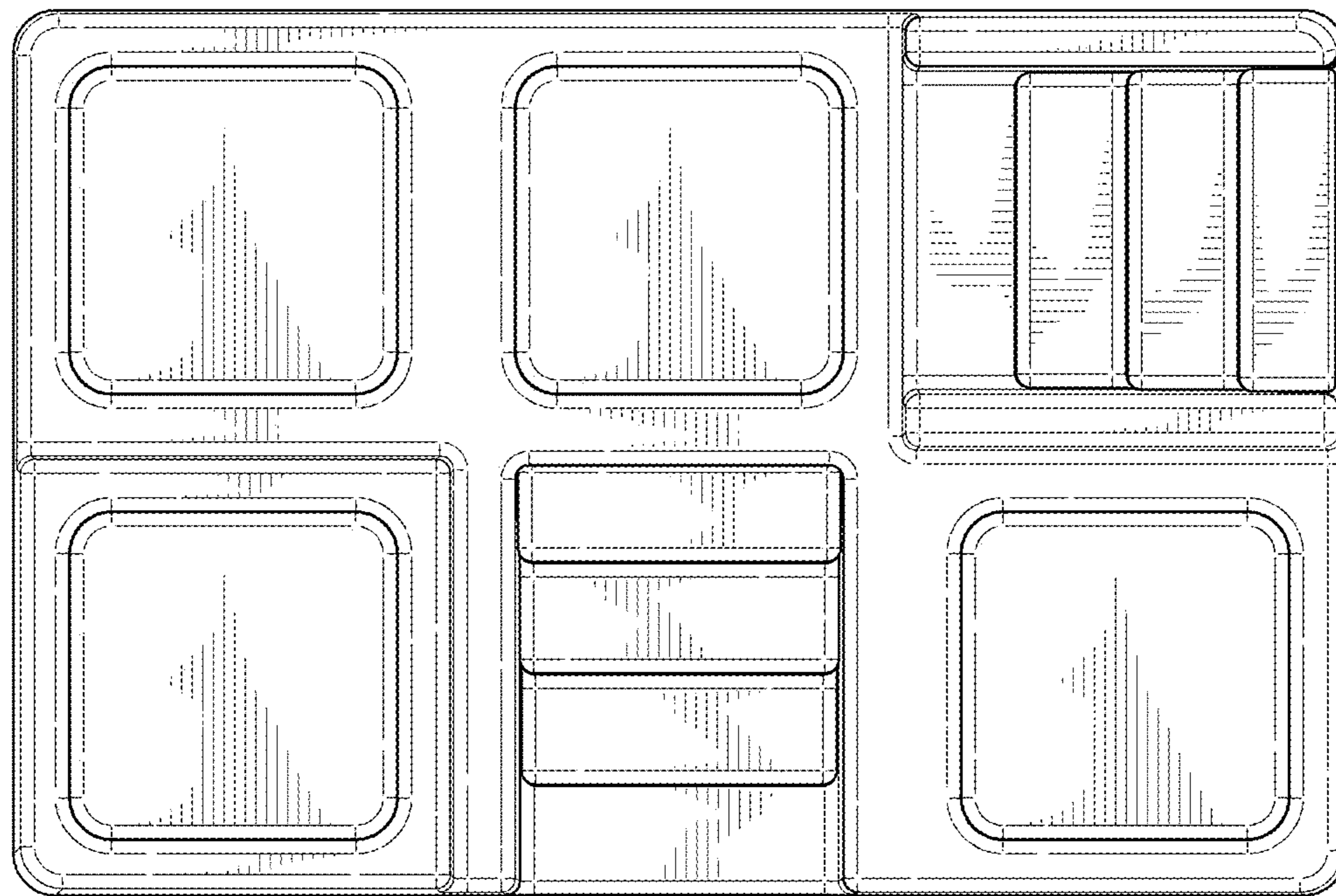


**FIG. 46**



**FIG. 47**





**FIG. 48**

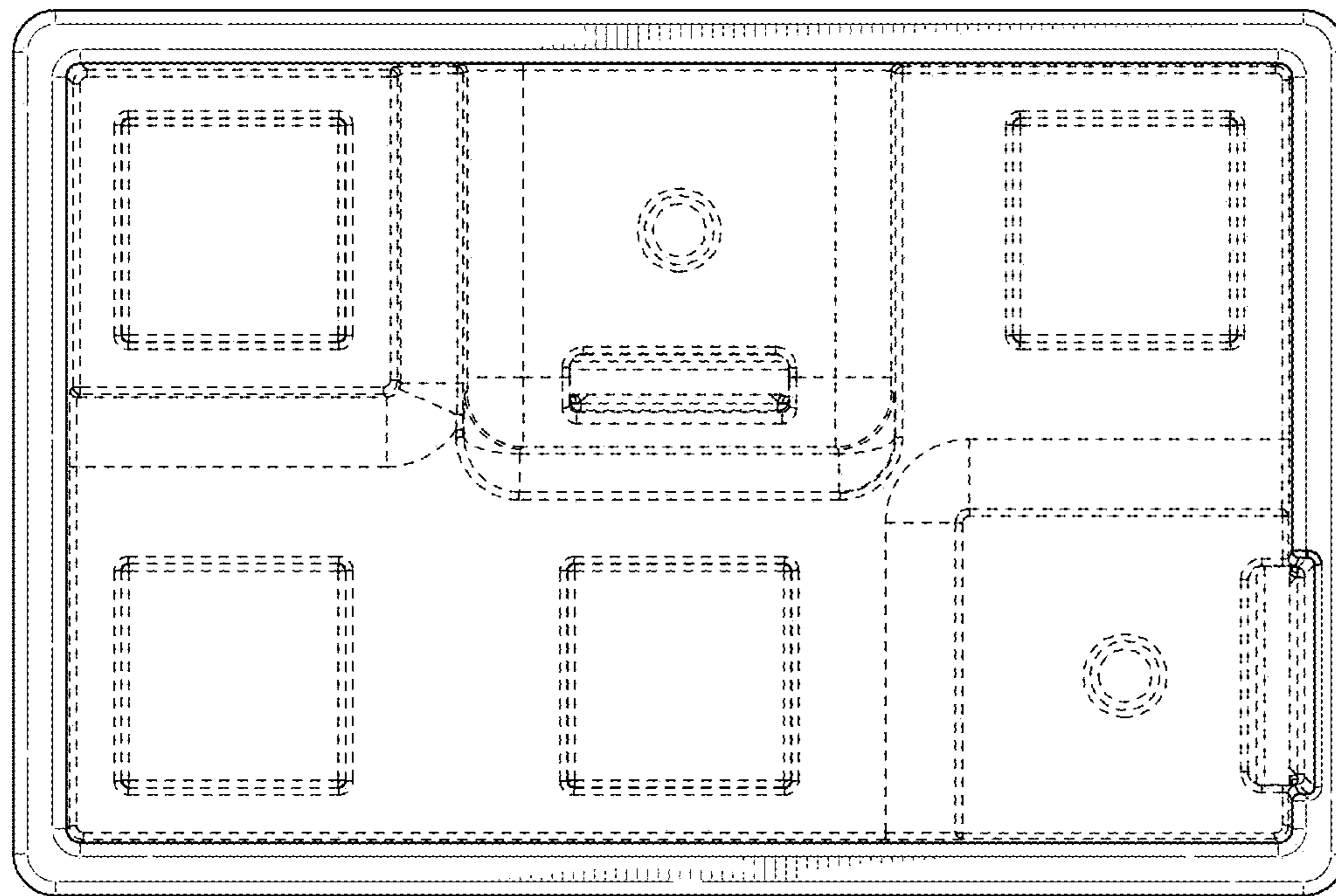
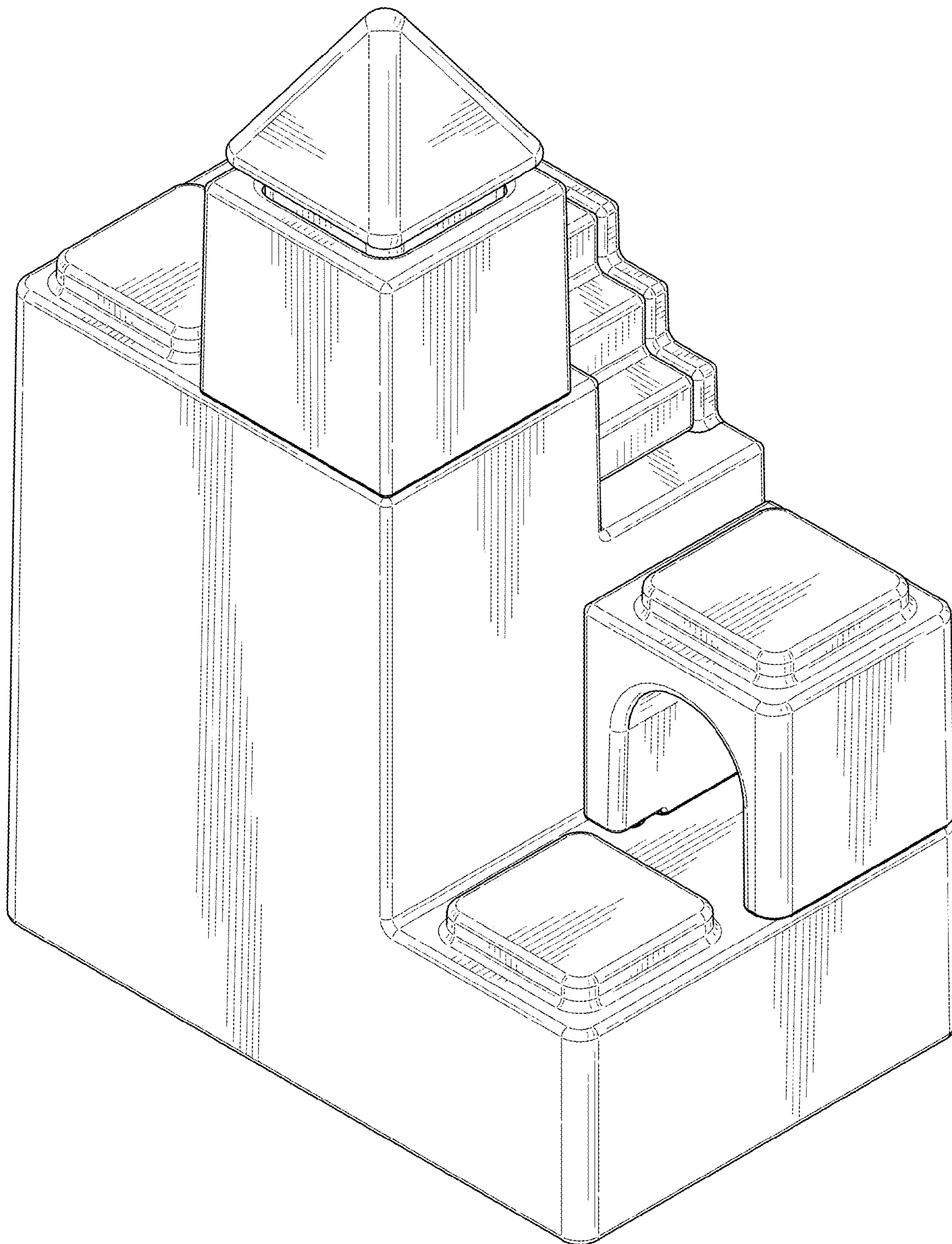
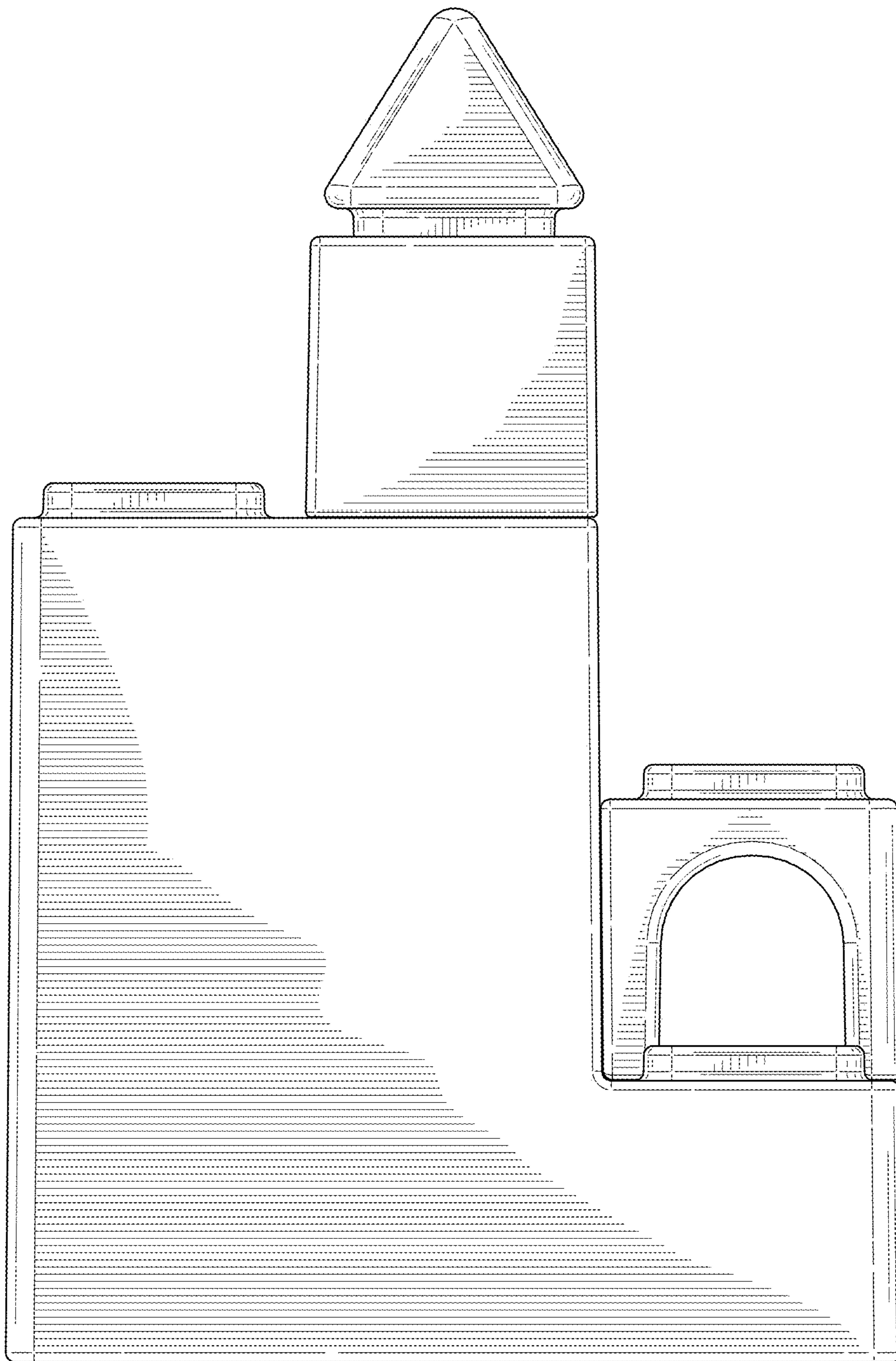


FIG. 49



**FIG. 50**





**FIG. 51**

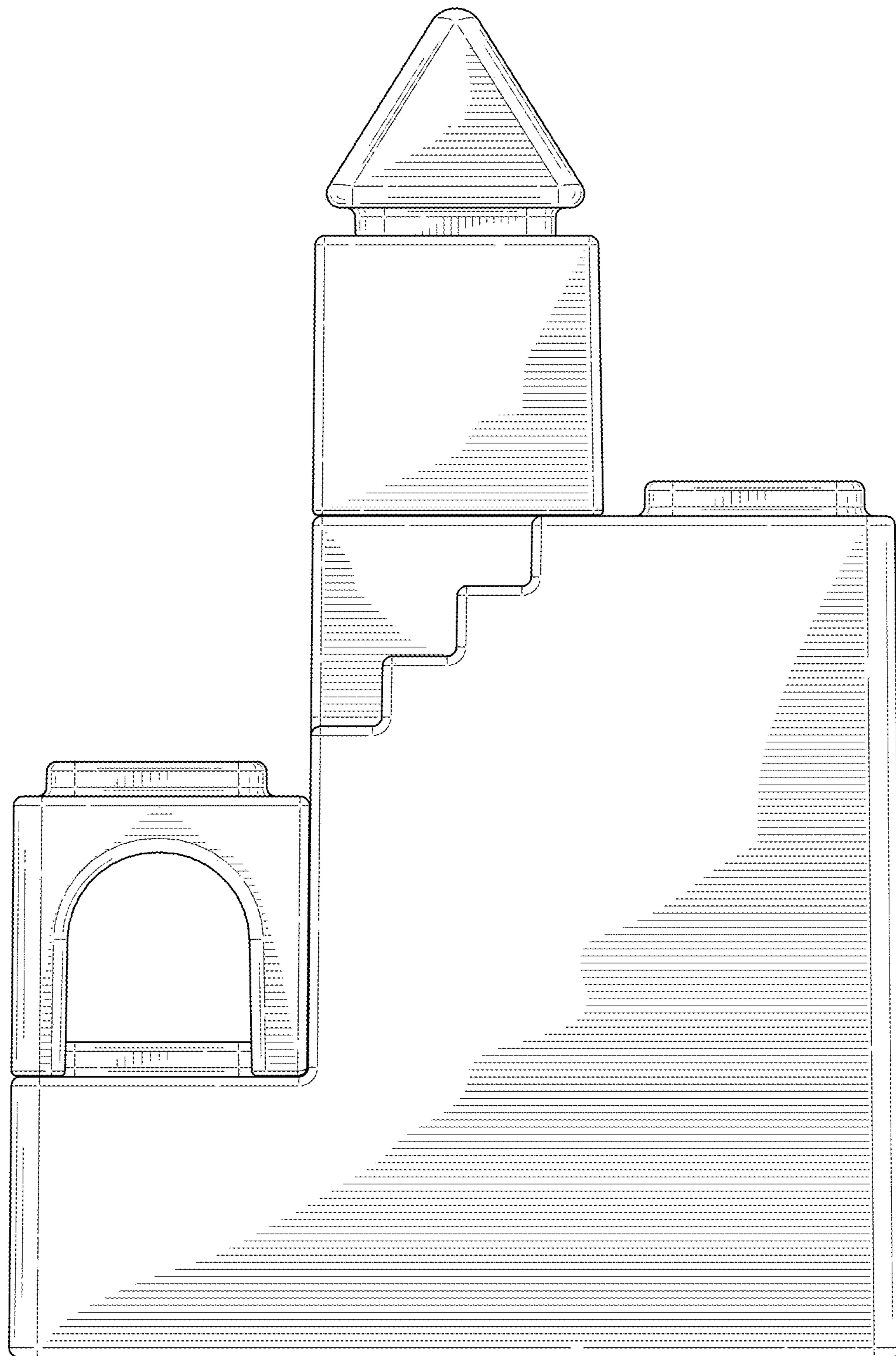
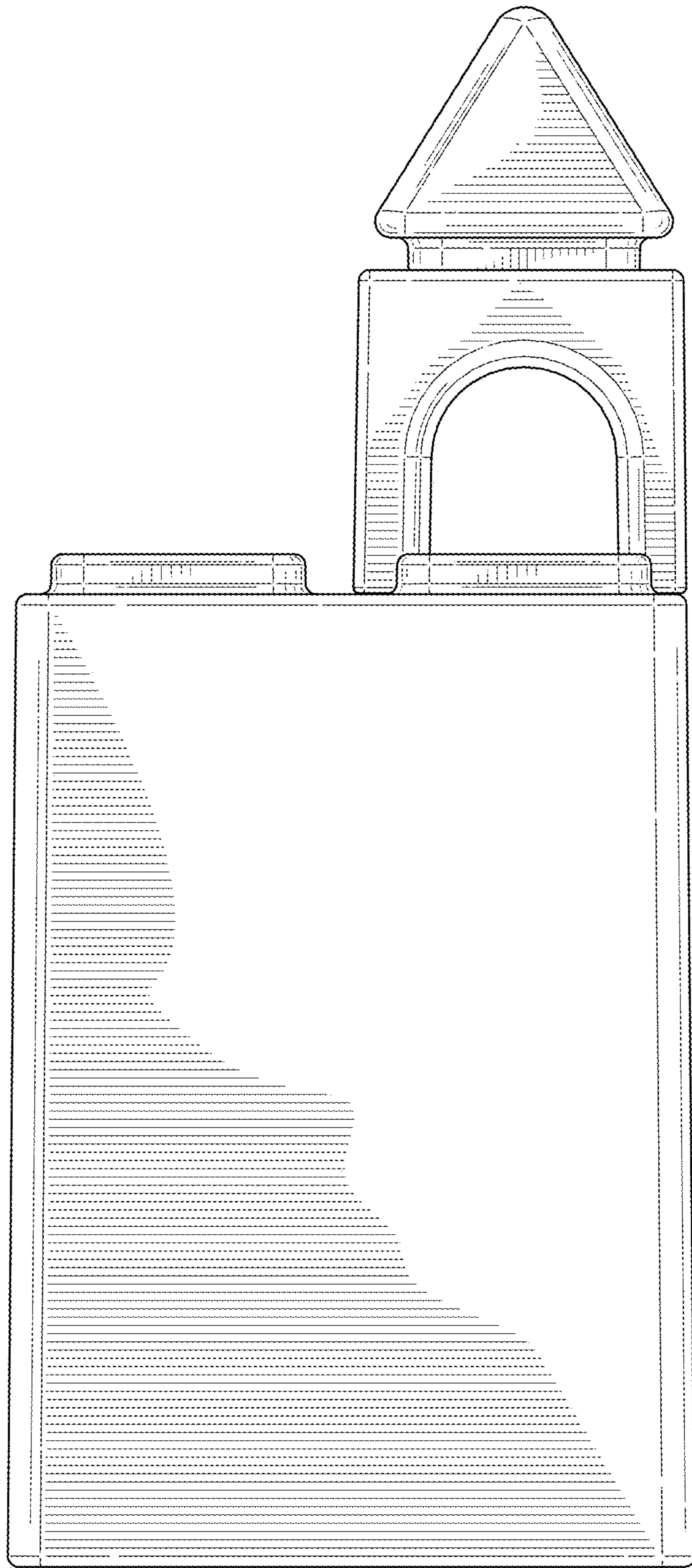
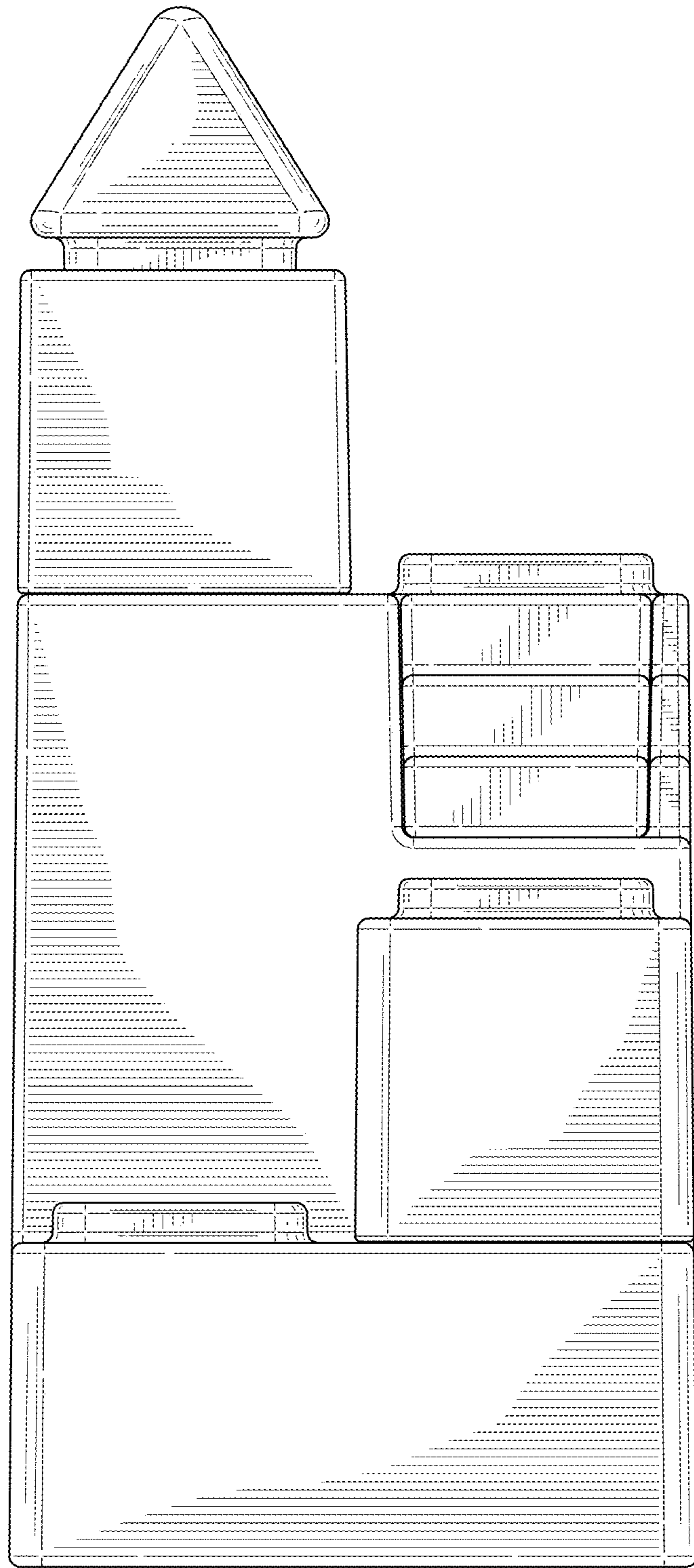


FIG. 52



**FIG. 53**





**FIG. 54**

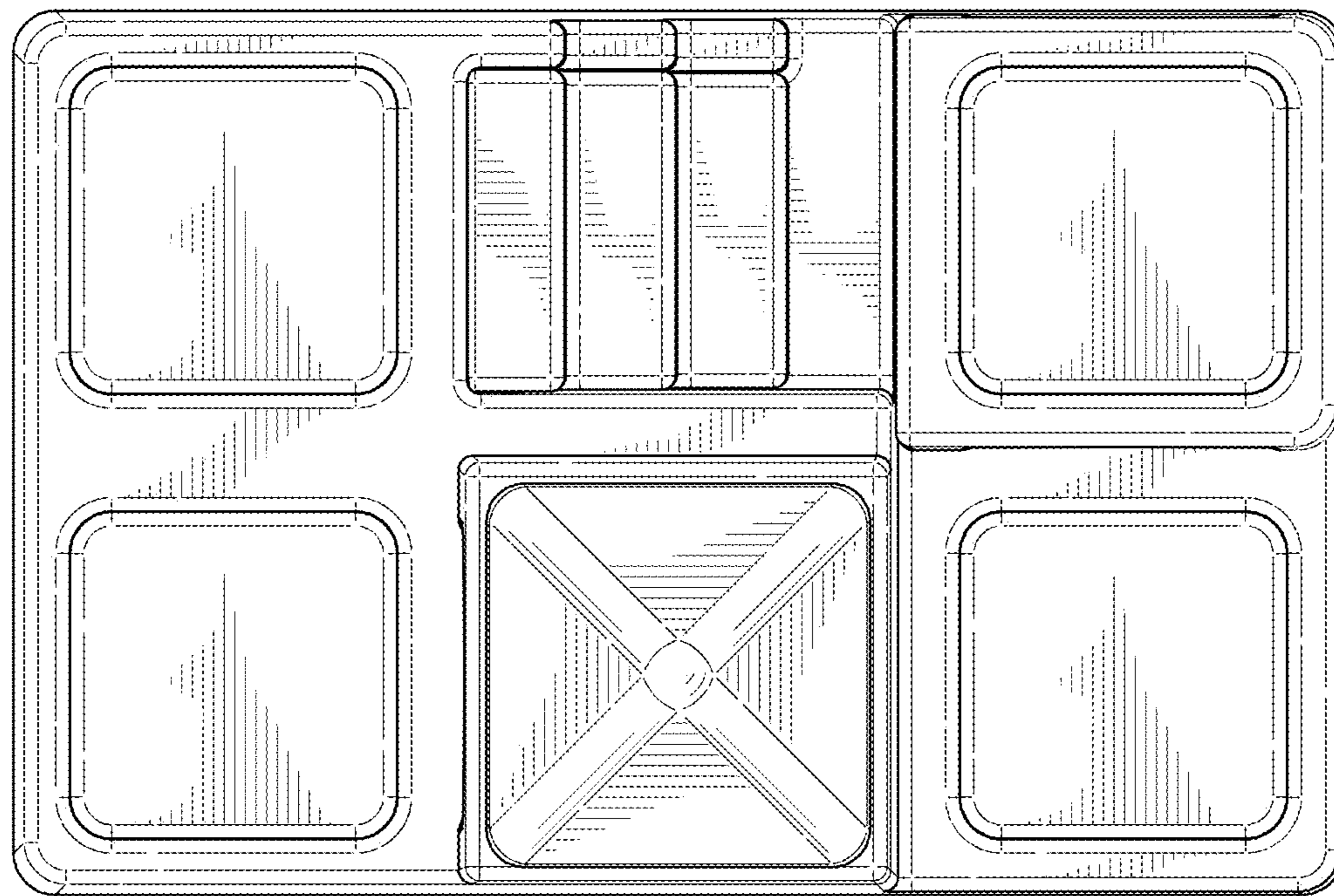


FIG. 55

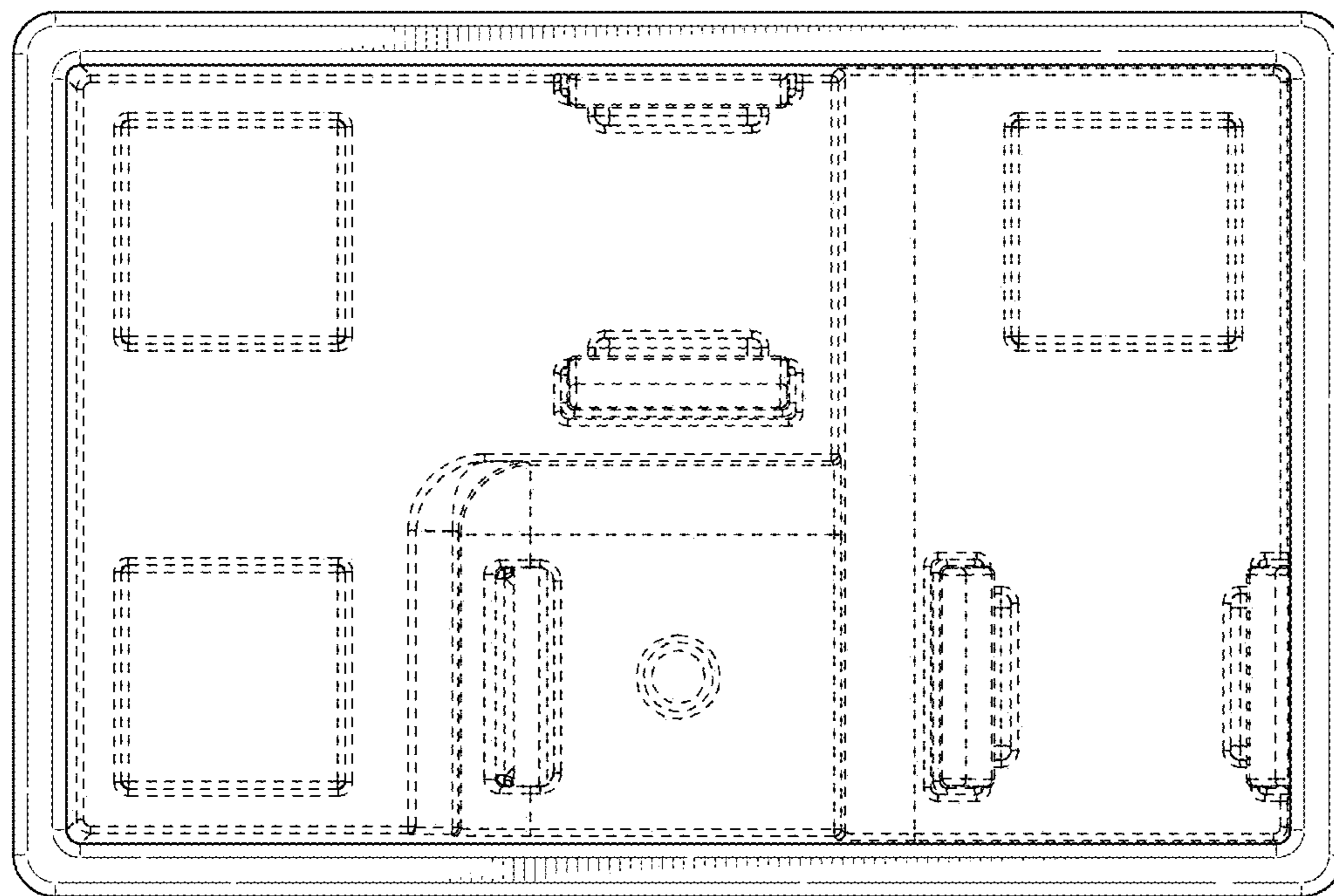


FIG. 56



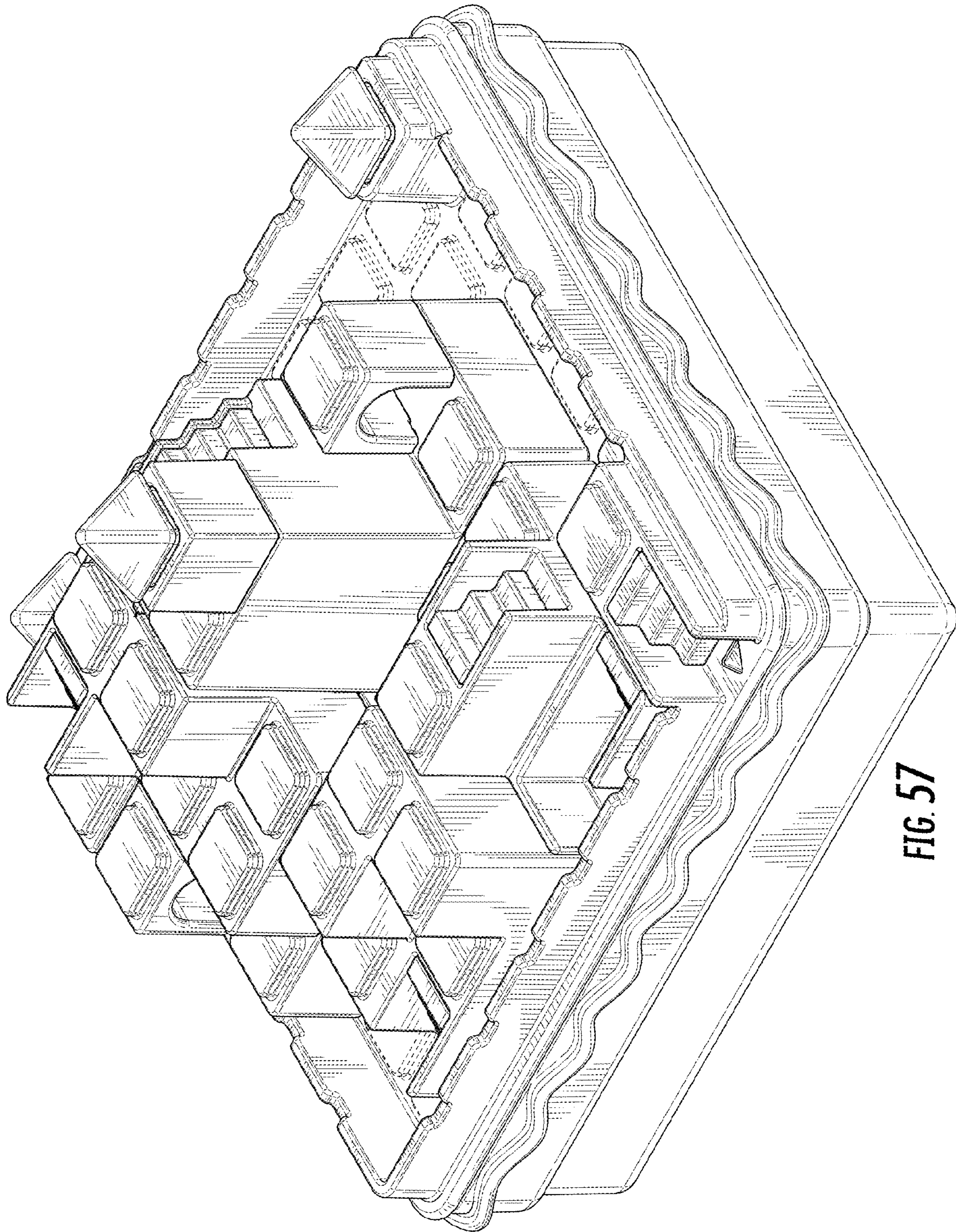


FIG. 57