



US00D911449S

(12) **United States Design Patent**
Peeters et al.

(10) **Patent No.:** **US D911,449 S**
(45) **Date of Patent:** **** Feb. 23, 2021**

(54) **GAME HOUSING AND GAME PIECES**

(71) Applicant: **SMART N.V.**, Kontich (BE)

(72) Inventors: **Raf Peeters**, Lier (BE); **Leighton Meredith Rees**, Cirencester (GB)

(73) Assignee: **SMART N.V.**, Kontich (BE)

(**) Term: **15 Years**

(21) Appl. No.: **29/688,159**

(22) Filed: **Apr. 18, 2019**

(30) **Foreign Application Priority Data**

Oct. 30, 2018 (EM) 005813094

(51) **LOC (13) Cl.** **21-01**

(52) **U.S. Cl.**

USPC **D21/335**; D21/342

(58) **Field of Classification Search**

USPC D21/334, 335-342, 355-359, 365, 318, D21/397, 351, 385, 386, 389, 404, 478, D21/479, 483-486, 489-491, 493, 494, D21/497-499, 507, 510, 511, 561; 273/241, 242, 244-247, 259, 275-277, 273/281, 282.1-282.3, 284-287, 317.3, 273/108.1, 108.5, 118 D, 236-240, 283, 273/309, 441, 461; D6/406.1, 406.3, D6/406.4, 406.6; D19/86, 92, 95, 87, D19/113, 75, 77, 78, 80; 108/14, 62, 43, 108/67; 434/416, 247, 248, 251, 408, 434/413, 145, 430

CPC A63F 3/00; A63F 3/00003; A63F 3/00028; A63F 3/00041; A63F 3/00044; A63F 3/00047; A63F 3/00173; A63F 3/00176; A63F 3/00214; A63F 3/00261; A63F 3/00643; A63F 3/00646-00659; A63F 3/04; A63F 3/00097; A63F 3/0434; A63F 3/00148; A63F 3/00697; A63F 3/0023; A63F 3/00895; A63F 3/00574; A63F 3/00694; A63F 2003/00182; A63F 3/00223; A63F 3/00457; A63F 3/0046;

A63F 3/00463; A63F 3/00466; A63F 3/0047; A63F 3/00485; A63F 3/00492; A63F 3/00507; A63F 3/00514; A63F 3/00533; A63F 3/00552; A63F 3/00558; A63F 3/00943; A63F 3/00946; A63F 3/00952-00962; A63F 2003/00974; A63F 7/00; A63F 7/06; A63F 7/0612; A63F 7/0604; A63F 7/0616-0636; A63F 7/30; A63F 7/36; A63F 7/0005; A63F 7/0017; A63F 7/0023; A63F 2007/0035; A63F 2007/367; A63F 2007/3674; A63F 9/00; A63F 9/08; A63F 9/001; A63F 9/0826; A63F 9/0073; A63F 9/0078; A63F 9/0602; A63F 9/0613; A63F 9/12-1208; A63F 9/1288; A63F 2009/0012; A63F 2009/1212-1228; A63F 2009/1292; A63F 2009/1296

See application file for complete search history.

(56) **References Cited**

U.S. PATENT DOCUMENTS

D17,127 S *	2/1887	Clark	D19/103
537,168 A *	4/1895	Ormsby	A63F 9/0078
				273/153 R
D55,496 S *	6/1920	White	D7/590
1,653,244 A *	12/1927	White	A61J 7/0069
				206/459.5
2,101,019 A *	12/1937	Bowes	E04B 5/32
				249/18
D110,770 S *	8/1938	Alger	D21/335
D111,647 S *	10/1938	Alger	D21/335
D115,126 S *	6/1939	Petersen et al.	D21/335
D122,589 S *	9/1940	Bastress	D7/553.5
D133,824 S *	9/1942	Young	D7/611
D135,930 S *	7/1943	Cobb	D21/342
D137,722 S *	4/1944	Triay	D21/366
D137,887 S *	5/1944	Shulman	D7/611
D139,220 S *	10/1944	Woodward et al.	D21/366
D143,719 S *	2/1946	Ernster	D7/611
D146,697 S *	4/1947	Bates	D7/553.8
D148,455 S *	1/1948	Bleitch et al.	D19/92
D150,414 S *	8/1948	Gulley	D7/611
2,501,379 A *	3/1950	Cranston	A47F 3/14
				206/509
D160,848 S *	11/1950	Ernster	D7/611
D162,742 S *	4/1951	Lorenzana et al.	D21/345
D168,933 S *	3/1953	Gamble	D21/335

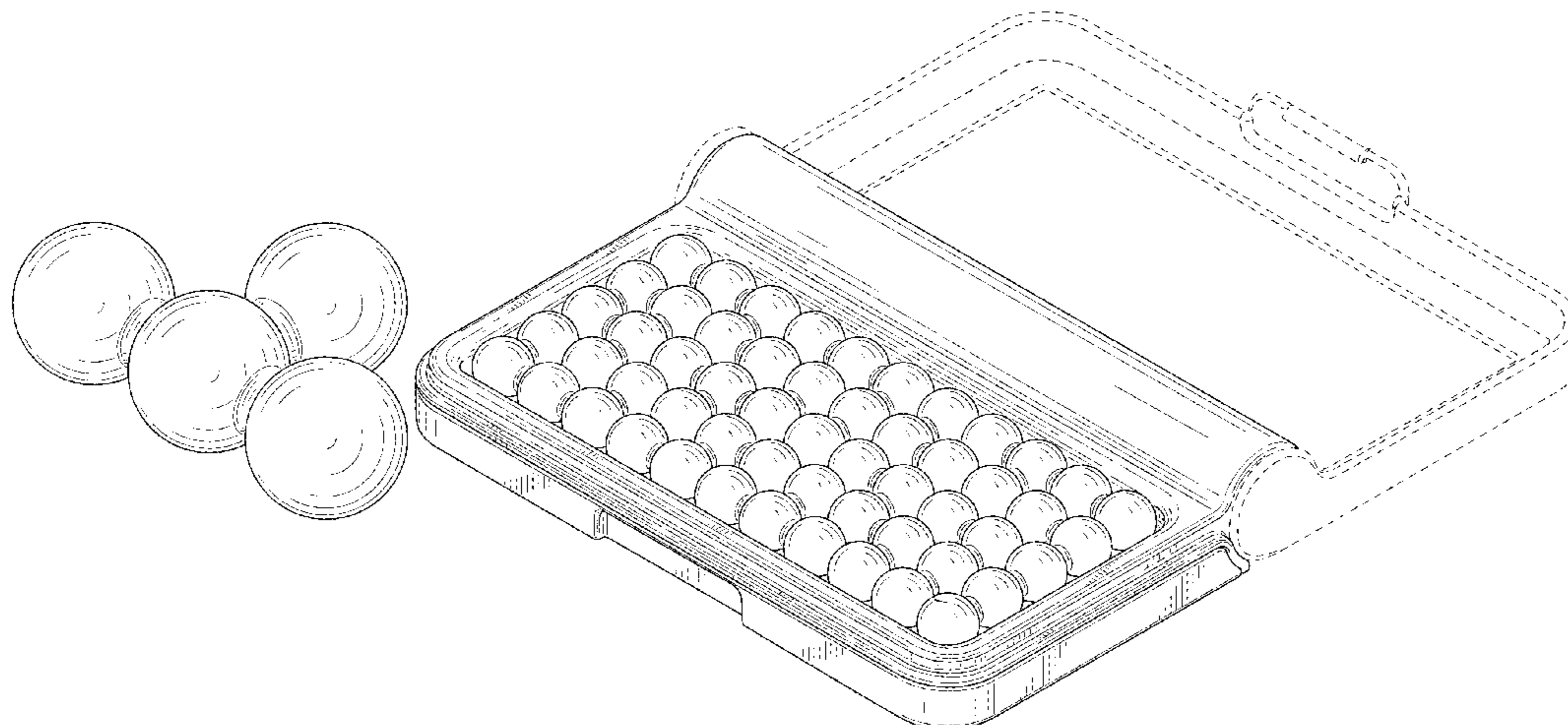

US D911,449 S

D172,958 S *	9/1954	Ferrucci	D19/103	D283,164 S *	3/1986	Pandya	D19/75
2,704,927 A *	3/1955	Carrell	F25C 1/24	D285,318 S *	8/1986	Propsom	D21/341
			62/382	4,648,524 A *	3/1987	Ackermann	A47B 88/969
2,757,934 A *	8/1956	Dunbar	A63F 3/0423				220/507
			273/272	D289,531 S *	4/1987	Coghill	D10/46.1
D188,987 S *	10/1960	Swimmer	D21/336	4,674,433 A *	6/1987	Inada	G09B 19/02
D192,672 S *	4/1962	Jenkins	D24/230				116/200
D197,134 S *	12/1963	Markham	D21/336	D294,668 S *	3/1988	Handler	D6/569
3,211,290 A *	10/1965	Strickling	B65B 21/18	D296,797 S *	7/1988	Andrews	D21/335
			209/522	D297,441 S *	8/1988	Smith, III	D21/335
3,273,700 A *	9/1966	Moreau et al.	B44D 3/04	4,783,081 A *	11/1988	Eckhardt	A63F 3/00261
			206/1.7				273/281
D206,761 S *	1/1967	Kirwan	D7/553.5	D299,287 S *	1/1989	Gertler	D12/419
D210,542 S *	3/1968	Stookey	D21/336	D299,933 S *	2/1989	Shalaon	D21/336
D210,613 S *	3/1968	Moore	F25D 25/00	4,819,945 A *	4/1989	Porcheddu	A63F 3/00634
			D7/611				273/272
3,382,632 A *	5/1968	Grofcsik	E04B 2/10	D301,575 S *	6/1989	Crawford, Jr.	D13/119
			52/223.7	D302,026 S *	7/1989	Tu	D19/75
D217,851 S *	6/1970	Yankovich	D3/313	4,872,723 A *	10/1989	Kopf	B60N 3/002
D222,522 S *	10/1971	Zipf	D3/313				297/216.1
D223,026 S *	2/1972	Rotkow	D19/59	4,896,889 A *	1/1990	Kuhn	A63F 1/10
D223,714 S *	5/1972	Kester	D10/46.1				273/150
D223,939 S *	6/1972	Palazzolo	D21/336	D308,699 S *	6/1990	Ancona	D19/75
D225,241 S *	11/1972	Westlake	D21/336	D309,687 S *	8/1990	Embree	D6/552
3,705,727 A *	12/1972	Breslow	A63F 3/06	D311,210 S *	10/1990	Bottcher	D19/103
			273/271	D319,348 S *	8/1991	Monteleon	D3/313
D230,870 S *	3/1974	Keim	D21/336	D320,619 S *	10/1991	Schleeh	D19/78
D232,646 S *	9/1974	Stubbmann	D21/345	5,052,549 A *	10/1991	Scharch	F42B 39/00
3,840,113 A *	10/1974	Bartleson	B44D 2/002				206/3
			206/575	5,054,789 A *	10/1991	Pellerin	A63F 3/0423
D234,781 S *	4/1975	White et al.	D21/336				273/288
3,929,337 A *	12/1975	Hayes	A63F 3/00697	D321,431 S *	11/1991	Dunkeld	D12/419
			273/243	D335,796 S *	5/1993	Barnes	D7/553.5
3,940,212 A *	2/1976	Gutner	F16B 12/14	D338,808 S *	8/1993	Anderson	D7/549
			403/306	D350,478 S *	9/1994	Fuller	D3/203.3
D239,334 S *	3/1976	Lowenstein	D19/77	D355,333 S *	2/1995	Campbell	D7/553.2
D242,157 S *	11/1976	Missinich	D21/336	D358,841 S *	5/1995	Ascone	D19/103
D245,118 S *	7/1977	Heaton	D24/230	D363,091 S *	10/1995	Dobis	D21/336
D246,945 S *	1/1978	Shore	D7/549	D363,856 S *	11/1995	Westbrooks, Jr.	D7/553.2
D247,533 S *	3/1978	Noyes	D6/514	D364,567 S *	11/1995	Dancel	D9/436
D247,647 S *	3/1978	Huber	D19/77	D368,736 S *	4/1996	Massena	D19/103
4,123,062 A *	10/1978	Wexler	A63F 3/00	D369,469 S *	5/1996	Gregory	D3/313
			273/248	D370,781 S *	6/1996	Vasudeva	D3/284
4,136,883 A *	1/1979	Klees	A63F 3/00261	5,560,612 A *	10/1996	Ippoliti	A63F 3/00574
			273/281				273/272
D251,644 S *	4/1979	Ravn	D6/571	D381,515 S *	7/1997	Haynes	D24/224
D253,071 S *	10/1979	Montez	D24/181	D393,543 S *	4/1998	Wilkening	D3/313
D253,126 S *	10/1979	Baxter	D24/226	5,738,108 A *	4/1998	Hein	A61B 5/411
D253,127 S *	10/1979	Baxter	D24/226				600/556
D255,129 S *	5/1980	Strongin	D21/341	D394,750 S *	6/1998	Iversen	D3/313
D255,310 S *	6/1980	Spencer	D7/553.5	D396,954 S *	8/1998	Iversen	D19/75
D256,081 S *	7/1980	Patterson	D3/311	D396,955 S *	8/1998	Iversen	D19/75
4,237,906 A *	12/1980	Havstad	A61B 17/205	D396,956 S *	8/1998	Iversen	D19/75
			215/250	D408,061 S *	4/1999	Borg	D21/337
4,244,581 A *	1/1981	Imatt	A63F 3/00574	D411,308 S *	6/1999	Pandey	D24/216
			273/236	D419,772 S *	2/2000	Williams	D3/201
4,254,957 A *	3/1981	Kramer	A63F 3/00574	D421,776 S *	3/2000	Borg	D21/336
			273/271	D434,456 S *	11/2000	Bracken	D21/336
D259,644 S *	6/1981	Israel	D21/336	D439,113 S *	3/2001	Claffy	D7/553.1
4,327,919 A *	5/1982	Vennor	A63F 3/00697	D443,299 S *	6/2001	Harrison	D19/103
			273/236	D450,351 S *	11/2001	Fong	D21/335
D264,857 S *	6/1982	Aitkens	D21/338	6,345,822 B1 *	2/2002	Reynolds	A63F 3/00261
D265,915 S *	8/1982	Tivey	D19/103				273/281
D266,728 S *	11/1982	Ivy	D7/693	D457,371 S *	5/2002	Grassman	D6/552
D267,023 S *	11/1982	Bowser	D21/336	D467,080 S *	12/2002	Zimmerman	D3/311
D268,130 S *	3/1983	Easton	D24/230	D467,980 S *	12/2002	Creech	D21/335
D268,353 S *	3/1983	Pilipski	D21/336	D484,919 S *	1/2004	Campos	D21/335
D270,170 S *	8/1983	Shoptaugh	D21/342	D490,244 S *	5/2004	Pero	D3/315
D272,923 S *	3/1984	Quinn	273/148 R	D504,563 S *	5/2005	Broussard	D3/20
D274,789 S *	7/1984	Brown	D9/758	D510,604 S *	10/2005	Deveaux, III	D21/335
D274,885 S *	7/1984	Joice	D9/758	D513,124 S *	12/2005	Funk	D3/313
D276,116 S *	10/1984	Basil	D7/541	D519,303 S *	4/2006	Winig	D6/682.2
4,474,371 A *	10/1984	Silbermintz	A63F 9/1204	D526,027 S *	8/2006	Smith	D21/336
			273/153 S	7,114,829 B2 *	10/2006	Lai	F21S 10/02
D279,384 S *	6/1985	Evenson	D19/75				362/231
D280,290 S *	8/1985	Bakus	D9/425	D538,354 S *	3/2007	Harman	D21/337
D282,265 S *	1/1986	Hyland	D21/336	D539,359 S *	3/2007	Rom	D21/478
D283,012 S *	3/1986	Jankens	D32/55				

7,219,895	B1 *	5/2007	Hutchins, Jr.	A63F 3/02	273/236
D545,379	S *	6/2007	Floden	D21/346	
D549,288	S *	8/2007	Droznika	D21/341	
D585,499	S *	1/2009	Kramer	D21/335	
D585,500	S *	1/2009	Kramer	D21/335	
D585,683	S *	2/2009	Nielsen	D6/629	
D589,626	S *	3/2009	Petersen	D24/230	
D592,401	S *	5/2009	Beavers	D3/304	
D596,758	S *	7/2009	Constable	D24/230	
D600,748	S *	9/2009	Tabuchi	D19/106	
D601,343	S *	10/2009	Franczyk	D3/313	
D606,774	S *	12/2009	Kohli	D6/406.6	
D607,516	S *	1/2010	DeOreo	D21/335	
D617,118	S *	6/2010	Fojtasek	D6/382	
D618,476	S *	6/2010	Maddux	D6/705	
D624,795	S *	10/2010	Koeleman	D7/706	
7,862,043	B2 *	1/2011	Kramer	A63F 3/0023	273/283
D634,541	S *	3/2011	Gutierrez	D3/313	
D639,866	S *	6/2011	Levasseur	D21/342	
D648,548	S *	11/2011	Winer	D6/300	
D651,538	S *	1/2012	Garzone	D11/178	
D656,201	S *	3/2012	Perrin	D21/335	
D657,824	S *	4/2012	Sorrell	D21/365	
D660,723	S *	5/2012	Akana	D9/737	
D661,950	S *	6/2012	Greenwood	D7/590	
D669,311	S *	10/2012	Hsu	D7/553.5	
8,302,801	B2 *	11/2012	Fried	B65D 21/086	220/508
D674,709	S *	1/2013	Akana	D9/737	
8,381,662	B2 *	2/2013	Goldszer	A47B 37/04	108/50.12
D678,409	S *	3/2013	Papenfuß	D19/106	
D680,379	S *	4/2013	Lackey	D7/553.2	
D685,654	S *	7/2013	Akana	D9/737	
D690,164	S *	9/2013	Lock	D7/553.2	
D695,078	S *	12/2013	Hertaus	D7/600.1	
D709,323	S *	7/2014	Brown	D7/402	
D713,051	S *	9/2014	Smeja	D24/230	
D714,958	S *	10/2014	Smeja	D24/230	
D729,549	S *	5/2015	Williams	D6/675	
D734,867	S *	7/2015	Smeja	D24/230	
D736,403	S *	8/2015	Hudson	D24/226	
D739,680	S *	9/2015	Smeja	D7/600.1	
D742,666	S *	11/2015	Akana	D6/682.2	
D744,159	S *	11/2015	Lukas	D27/183	
D746,637	S *	1/2016	Mairinger	D7/553.2	
D750,443	S *	3/2016	Kraemer	D7/611	
9,393,075	B2 *	7/2016	Ghosh	A61B 46/10	
D767,309	S *	9/2016	Akana	D6/682.2	
D769,678	S *	10/2016	Jussen	D7/701	
9,486,294	B2 *	11/2016	Ghosh	A61B 50/13	
D785,406	S *	5/2017	Wansink	D7/553.2	
D789,749	S *	6/2017	Tsai	D7/600.1	
D789,750	S *	6/2017	Noe	D7/600.1	
9,694,289	B2 *	7/2017	Thomas	A63F 13/822	
D793,813	S *	8/2017	Dubois	D7/553.2	
D793,856	S *	8/2017	Akana	D9/425	
D795,704	S *	8/2017	Tanus	D9/737	
9,788,913	B2 *	10/2017	Ghosh	A61B 46/00	
D802,678	S *	11/2017	Wimer	D21/336	
D804,261	S *	12/2017	Almaguer	D7/701	
D807,129	S *	1/2018	Martinez	D7/701	
D820,330	S *	6/2018	Di Monte, Sr.	D15/140	
D820,623	S *	6/2018	Akana	D6/682.4	
D820,690	S *	6/2018	Canuto	D9/757	
D826,425	S *	8/2018	Muller	D24/230	
D826,426	S *	8/2018	Muller	D24/230	
D827,432	S *	9/2018	Akana	D9/436	
D834,365	S *	11/2018	Hundley	D7/391	
D836,832	S *	12/2018	Kesselman	D27/186	
D836,991	S *	1/2019	Wansink	D7/553.5	
D838,553	S *	1/2019	Kraemer	D7/611	
10,166,464	B2 *	1/2019	Todokoro	A63F 9/0803	
D840,053	S *	2/2019	Kamees	D24/230	
D840,249	S *	2/2019	Payne	D9/760	
D844,375	S *	4/2019	Hundley	D7/391	
D844,806	S *	4/2019	Johns	D24/227	

D859,979	S *	9/2019	Akana	D9/432
D863,449	S *	10/2019	Shoptaugh	D21/342
D864,304	S *	10/2019	Macadam	D21/337
D872,187	S *	1/2020	Hsu	D21/343
D873,572	S *	1/2020	Hofer	D4/134
D873,660	S *	1/2020	Akana	D9/436
D884,798	S *	5/2020	Hsu	D21/342
D886,202	S *	6/2020	Hsu	D21/342
D897,449	S *	9/2020	Xu	D21/468
2002/0113370	A1 *	8/2002	Pickering	A63F 3/00094
				273/271
2003/0006553	A1 *	1/2003	Veguilla	A63F 3/02
				273/281
2005/0265129	A1 *	12/2005	Agnoff	G04B 3/006
				368/206
2006/0283767	A1 *	12/2006	White West	A45D 19/00
				206/557

* cited by examiner

Primary Examiner — Susan Moon Lee

(74) Attorney, Agent, or Firm — Hodgson Russ LLP

(57)

CLAIM

The ornamental design for a game housing and game pieces, as shown and described.

DESCRIPTION

FIG. 1 is an open configuration, top perspective view of the game housing component of our design for a game housing and game pieces, shown separately from the game pieces for clarity of illustration; FIG. 2 is a front elevational of the game housing of FIG. 1; FIG. 3 is a rear elevational of the game housing of FIG. 1; FIG. 4 is a left side view of the game housing of FIG. 1; FIG. 5 is a right side view of the game housing of FIG. 1; FIG. 6 is a top view of the game housing of FIG. 1; FIG. 7 is a bottom view of the game housing of FIG. 1; FIG. 8 is a top perspective view of a game piece, shown separately for clarity of illustration; FIG. 9 is a front elevational view of the game piece of FIG. 8; FIG. 10 is a rear elevational view of the game piece of FIG. 8; FIG. 11 is a right side view of the game piece of FIG. 8; FIG. 12 is a left side view of the game piece of FIG. 8; FIG. 13 is a top view of the game piece of FIG. 8; FIG. 14 is a bottom view of the game piece of FIG. 8; FIG. 15 is a top perspective view of a game piece, shown separately for clarity of illustration; FIG. 16 is a front elevational view of the game piece of FIG. 15; FIG. 17 is a rear elevational view of the game piece of FIG. 15; FIG. 18 is a right side view of the game piece of FIG. 15; FIG. 19 is a left side view of the game piece of FIG. 15; FIG. 20 is a top view of the game piece of FIG. 15; FIG. 21 is a bottom view of the game piece of FIG. 15; FIG. 22 is a top perspective view of a game piece, shown separately for clarity of illustration; FIG. 23 is a front elevational view of the game piece of FIG. 22; FIG. 24 is a rear elevational view of the game piece of FIG. 22; FIG. 25 is a right side view of the game piece of FIG. 22; FIG. 26 is a left side view of the game piece of FIG. 22; FIG. 27 is a top view of the game piece of FIG. 22;

FIG. 28 is a bottom view of the game piece of FIG. 22;
 FIG. 29 is a top perspective view of a game piece, shown separately for clarity of illustration;
 FIG. 30 is a front elevational view of the game piece of FIG. 29;
 FIG. 31 is a rear elevational view of the game piece of FIG. 29;
 FIG. 32 is a right side view of the game piece of FIG. 29;
 FIG. 33 is a left side view of the game piece of FIG. 29;
 FIG. 34 is a top view of the game piece of FIG. 29;
 FIG. 35 is a bottom view of the game piece of FIG. 29;
 FIG. 36 is a top perspective view of a game piece, shown separately for clarity of illustration;
 FIG. 37 is a front elevational view of the game piece of FIG. 37;
 FIG. 38 is a rear elevational view of the game piece of FIG. 37;
 FIG. 39 is a right side view of the game piece of FIG. 37;
 FIG. 40 is a left side view of the game piece of FIG. 37;
 FIG. 41 is a top view of the game piece of FIG. 37;
 FIG. 42 is a bottom view of the game piece of FIG. 37;
 FIG. 43 is a top perspective view of a game piece, shown separately for clarity of illustration;
 FIG. 44 is a front elevational view of the game piece of FIG. 43;
 FIG. 45 is a rear elevational view of the game piece of FIG. 43;
 FIG. 46 is a right side view of the game piece of FIG. 43;
 FIG. 47 is a left side view of the game piece of FIG. 43;
 FIG. 48 is a top view of the game piece of FIG. 43;
 FIG. 49 is a bottom view of the game piece of FIG. 43;
 FIG. 50 is a top perspective view of a game piece, shown separately for clarity of illustration;
 FIG. 51 is a front elevational view of the game piece of FIG. 50;
 FIG. 52 is a rear elevational view of the game piece of FIG. 50;
 FIG. 53 is a right side view of the game piece of FIG. 50;
 FIG. 54 is a left side view of the game piece of FIG. 50;
 FIG. 55 is a top view of the game piece of FIG. 50;
 FIG. 56 is a bottom view of the game piece of FIG. 50;
 FIG. 57 is a top perspective view of a game piece, shown separately for clarity of illustration;
 FIG. 58 is a front elevational view of the game piece of FIG. 57;
 FIG. 59 is a rear elevational view of the game piece of FIG. 57;
 FIG. 60 is a right side view of the game piece of FIG. 57;
 FIG. 61 is a left side view of the game piece of FIG. 57;
 FIG. 62 is a top view of the game piece of FIG. 57;

FIG. 63 is a bottom view of the game piece of FIG. 57;
 FIG. 64 is a top perspective view of a game piece, shown separately for clarity of illustration;
 FIG. 65 is a front elevational view of the game piece of FIG. 64;
 FIG. 66 is a rear elevational view of the game piece of FIG. 64;
 FIG. 67 is a right side view of the game piece of FIG. 64;
 FIG. 68 is a left side view of the game piece of FIG. 64;
 FIG. 69 is a top view of the game piece of FIG. 64;
 FIG. 70 is a bottom view of the game piece of FIG. 64;
 FIG. 71 is a top perspective view of a game piece, shown separately for clarity of illustration;
 FIG. 72 is a front elevational view of the game piece of FIG. 71;
 FIG. 73 is a rear elevational view of the game piece of FIG. 71;
 FIG. 74 is a right side view of the game piece of FIG. 71;
 FIG. 75 is a left side view of the game piece of FIG. 71;
 FIG. 76 is a top view of the game piece of FIG. 71;
 FIG. 77 is a bottom view of the game piece of FIG. 71;
 FIG. 78 is a top perspective view of a game piece, shown separately for clarity of illustration;
 FIG. 79 is a front elevational view of the game piece of FIG. 78;
 FIG. 80 is a rear elevational view of the game piece of FIG. 78;
 FIG. 81 is a right side view of the game piece of FIG. 78;
 FIG. 82 is a left side view of the game piece of FIG. 78;
 FIG. 83 is a top view of the game piece of FIG. 78;
 FIG. 84 is a bottom view of the game piece of FIG. 78;
 FIG. 85 is a top perspective view of a game piece, shown separately for clarity of illustration;
 FIG. 86 is a front elevational view of the game piece of FIG. 85;
 FIG. 87 is a rear elevational view of the game piece of FIG. 85;
 FIG. 88 is a right side view of the game piece of FIG. 85;
 FIG. 89 is a left side view of the game piece of FIG. 85;
 FIG. 90 is a top view of the game piece of FIG. 85;
 FIG. 91 is a bottom view of the game piece of FIG. 85;
 FIG. 92 is a top perspective view of the game housing component of FIG. 1, shown in a closed configuration; and,
 FIG. 93 is a top perspective view of the game housing and game pieces of the present design, shown in an open configuration.
 The evenly-dashed broken lines in the drawings illustrate the portions of the game pieces and game housing that form no part of the claim.

1 Claim, 67 Drawing Sheets

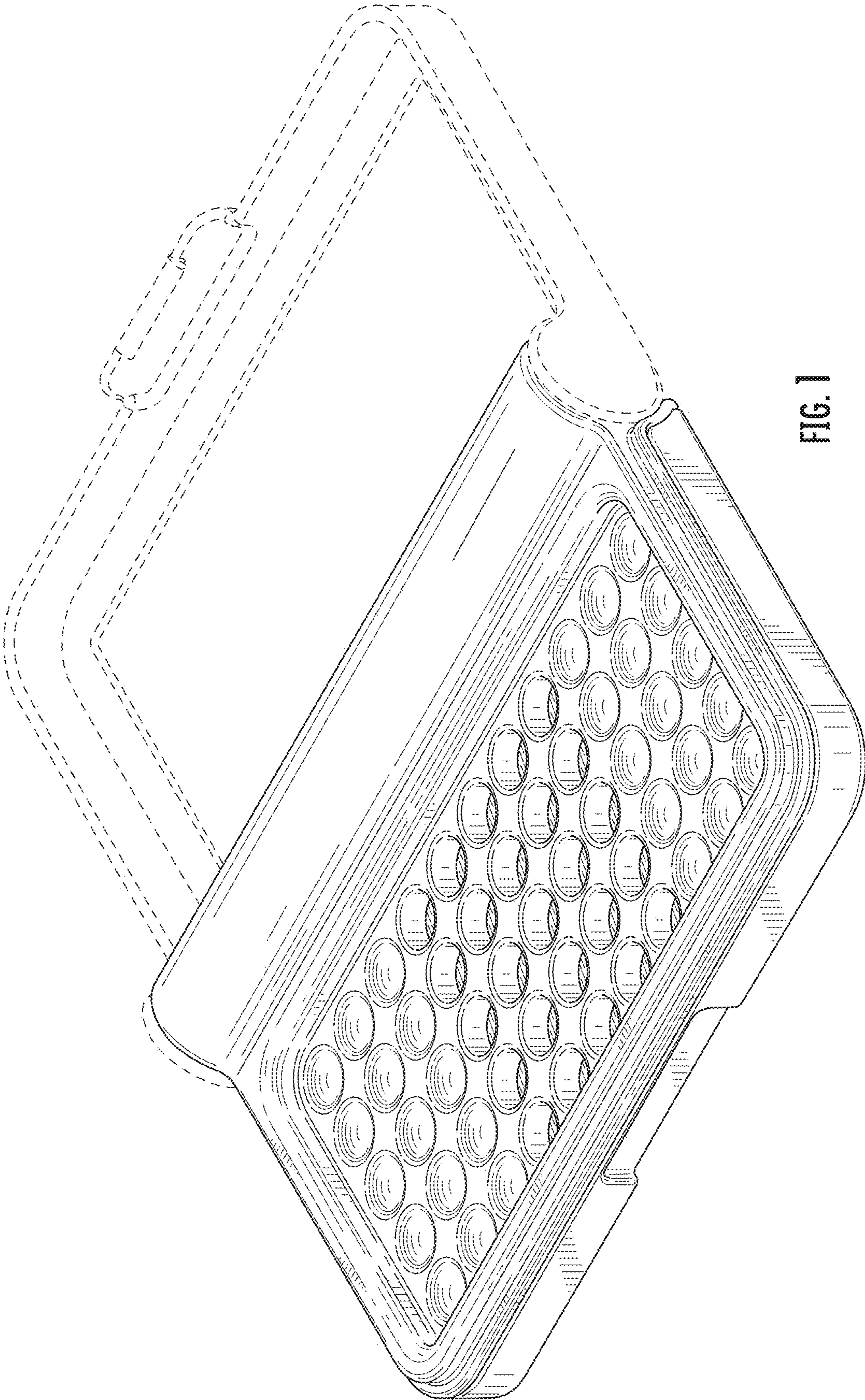

FIG. 1

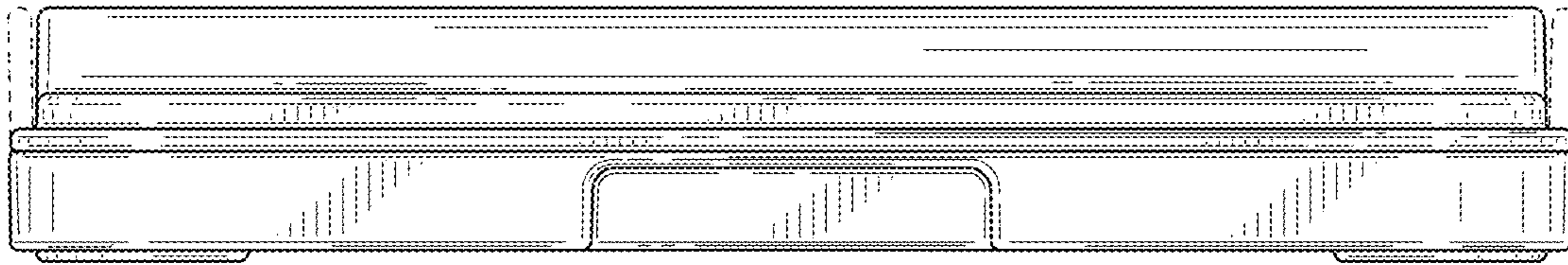

FIG. 2

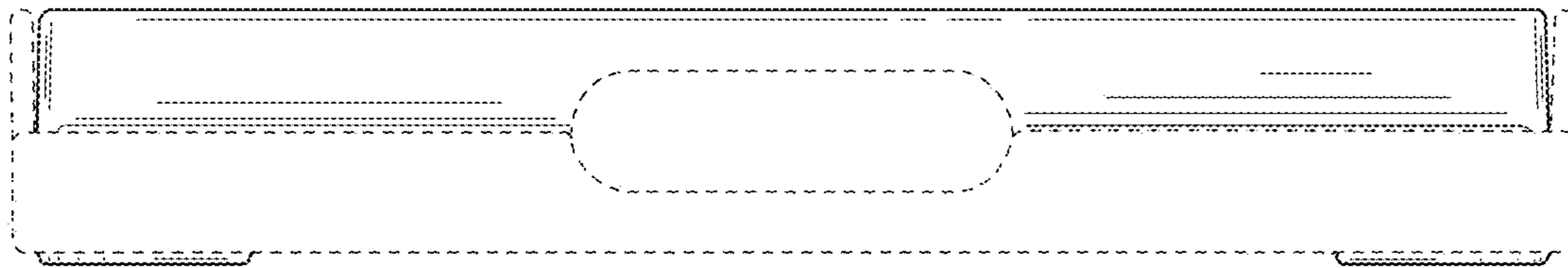

FIG. 3

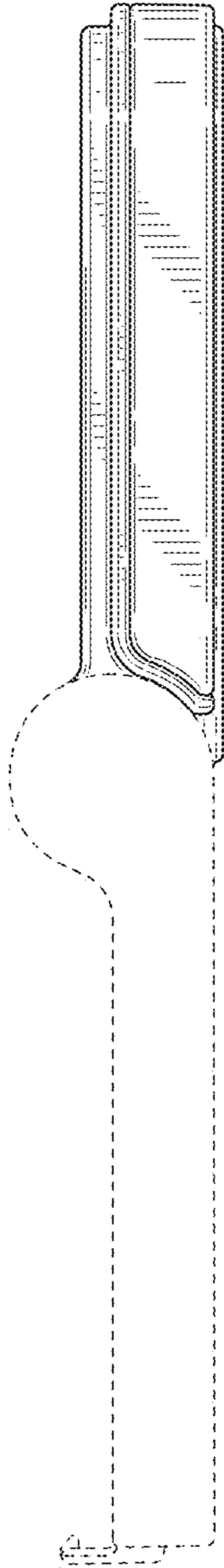

FIG. 4

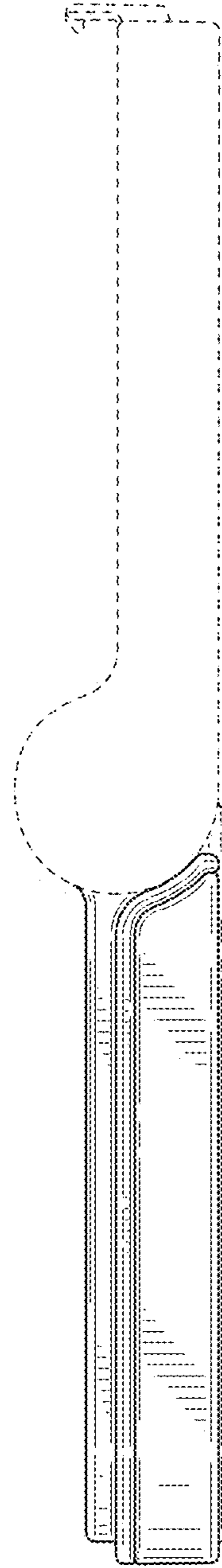

FIG. 5

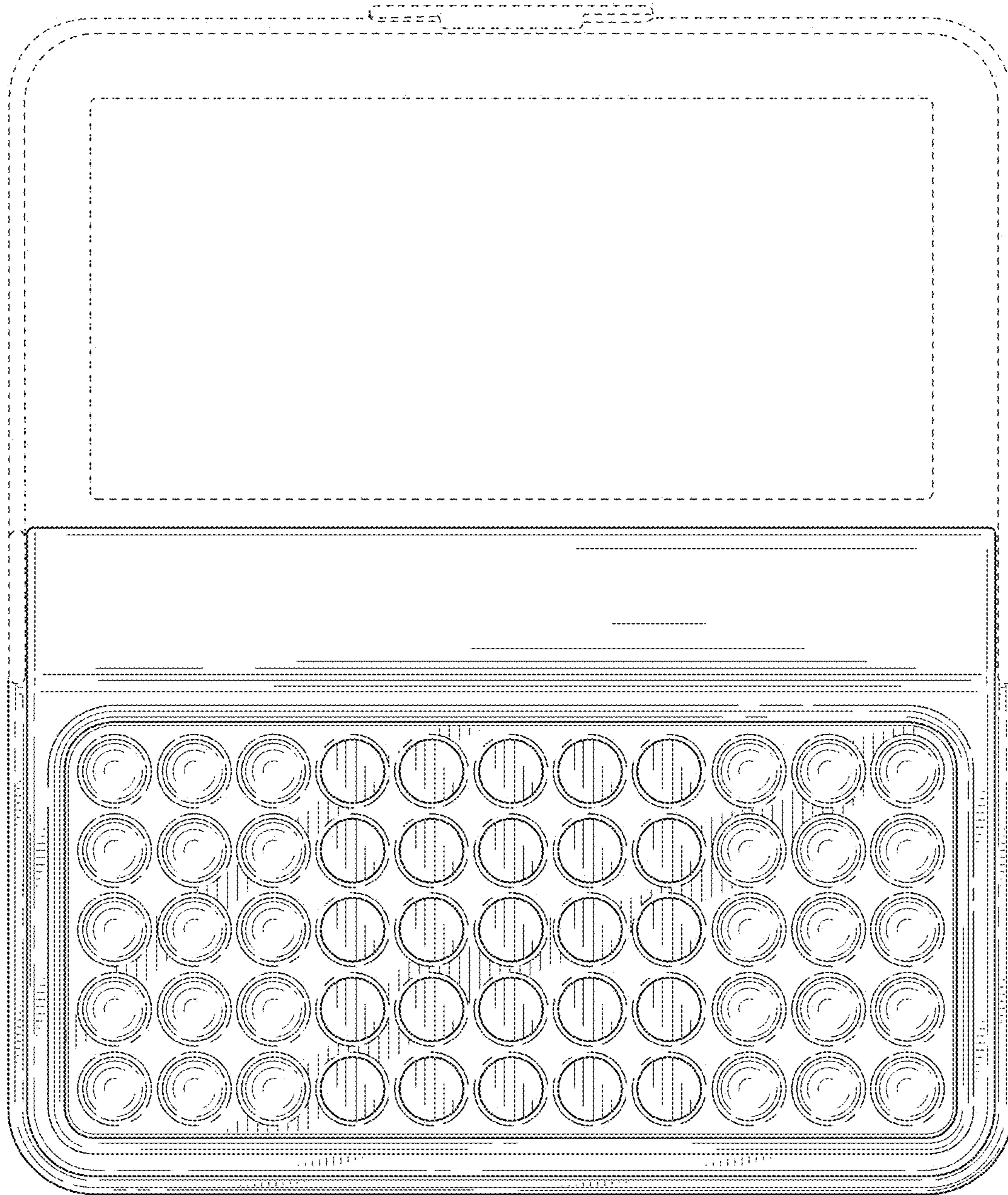

FIG. 6

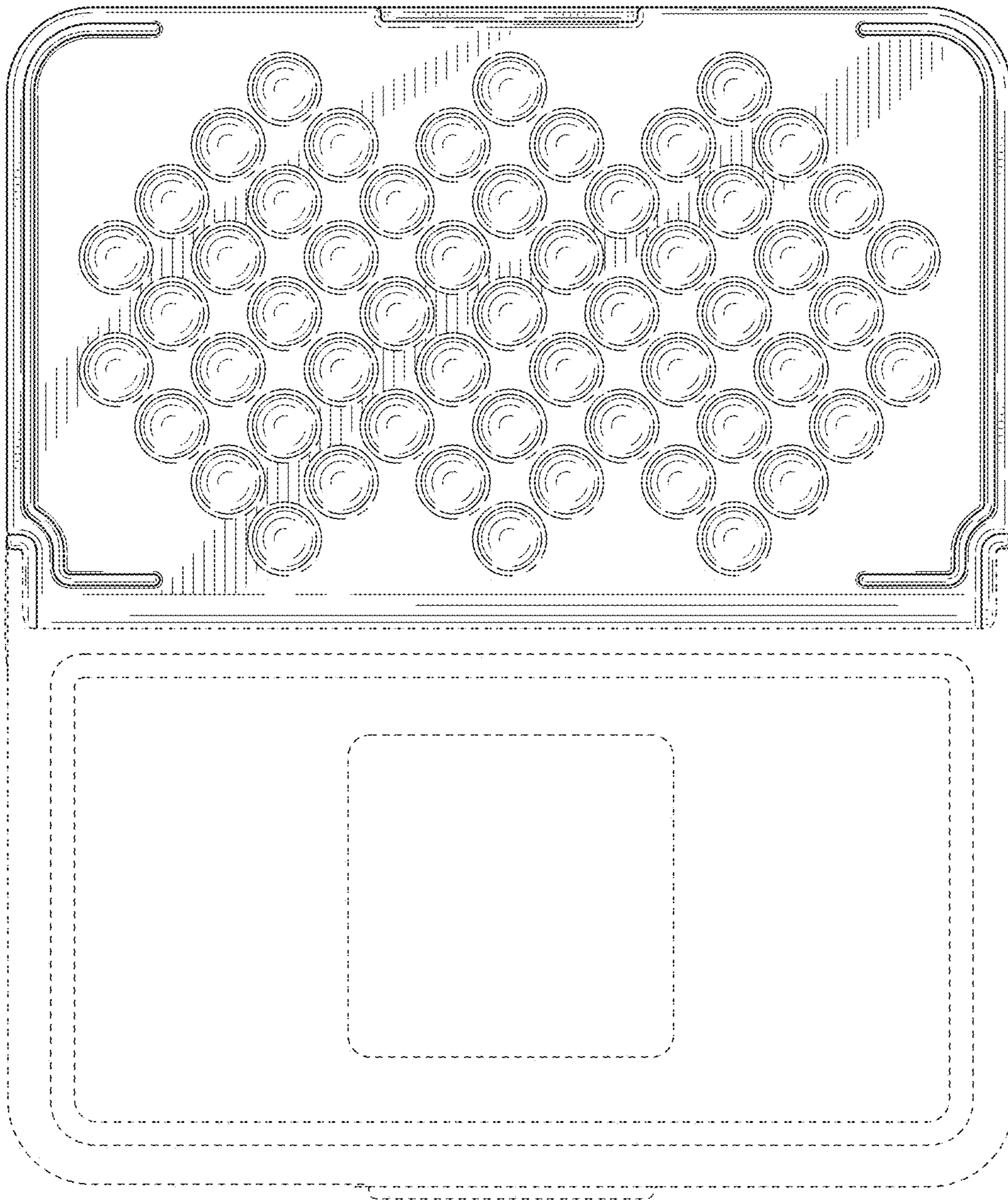

FIG. 7

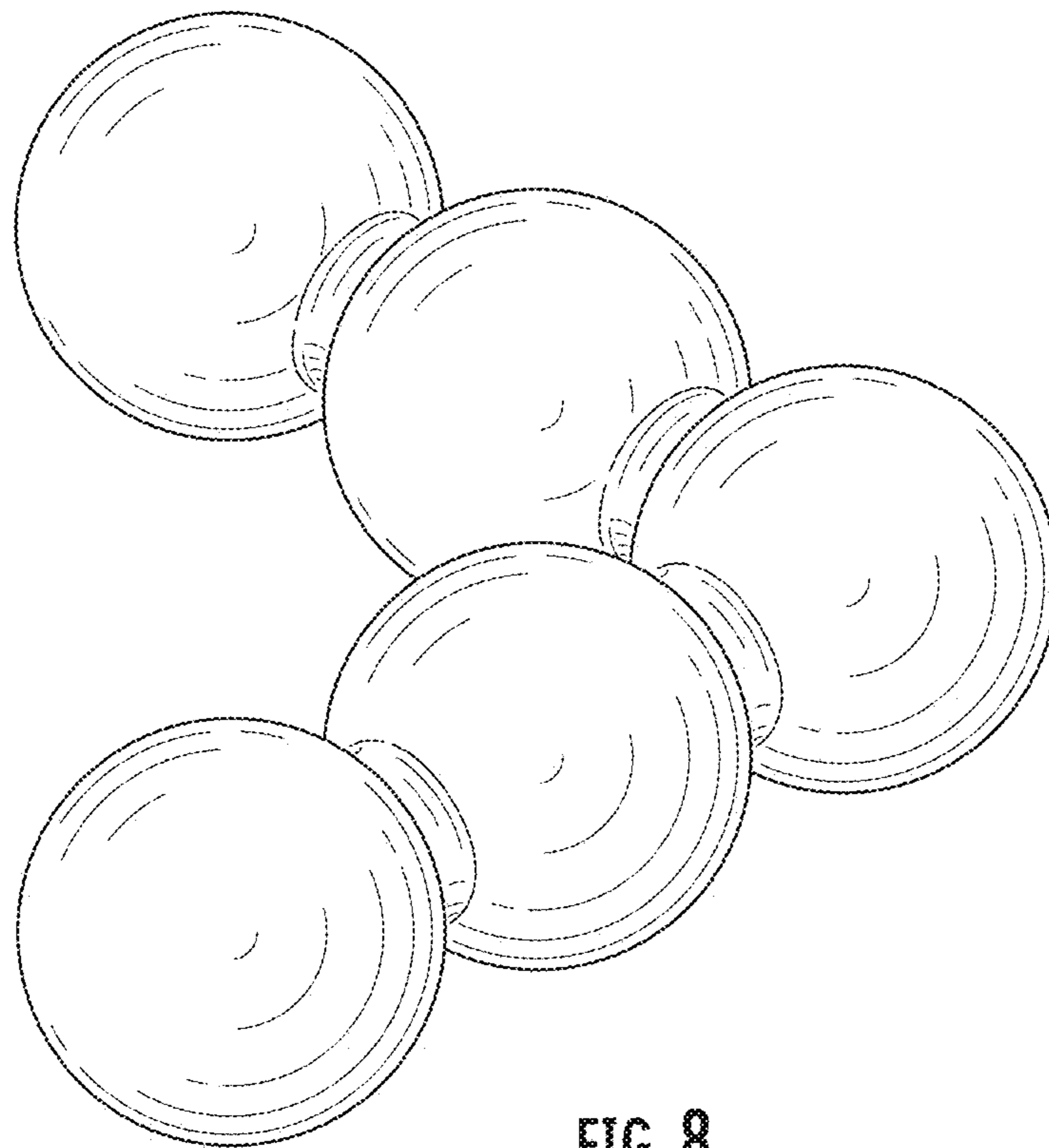

FIG. 8

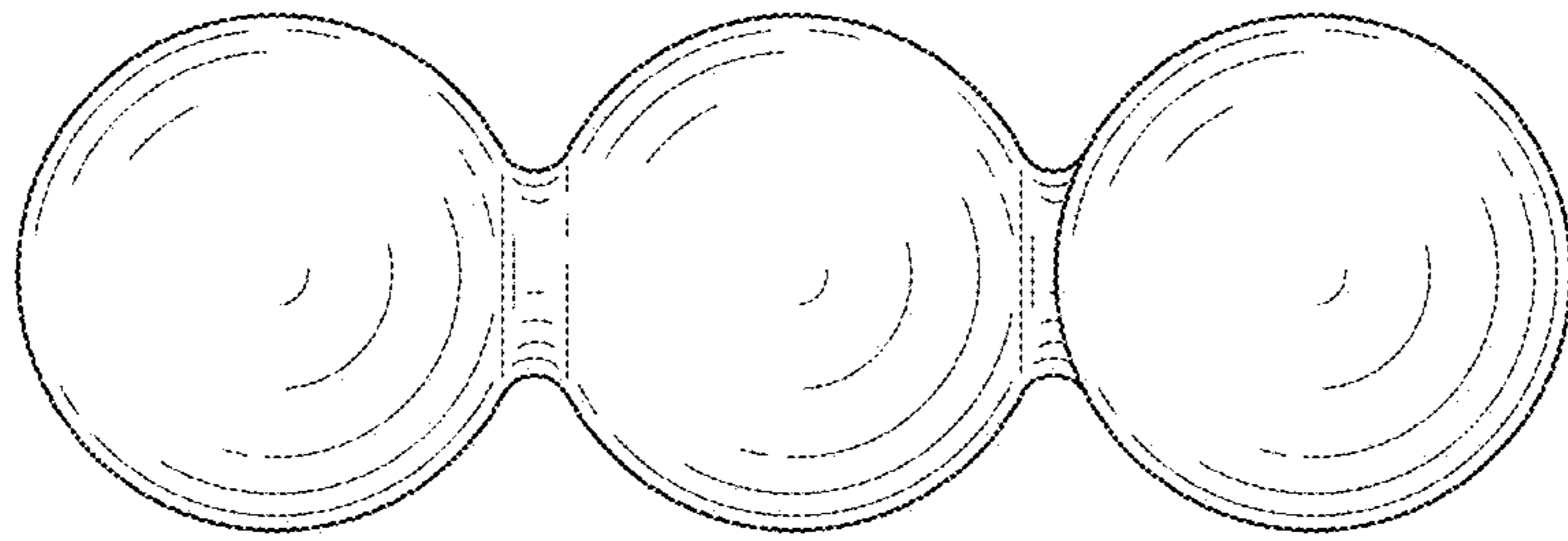

FIG. 9

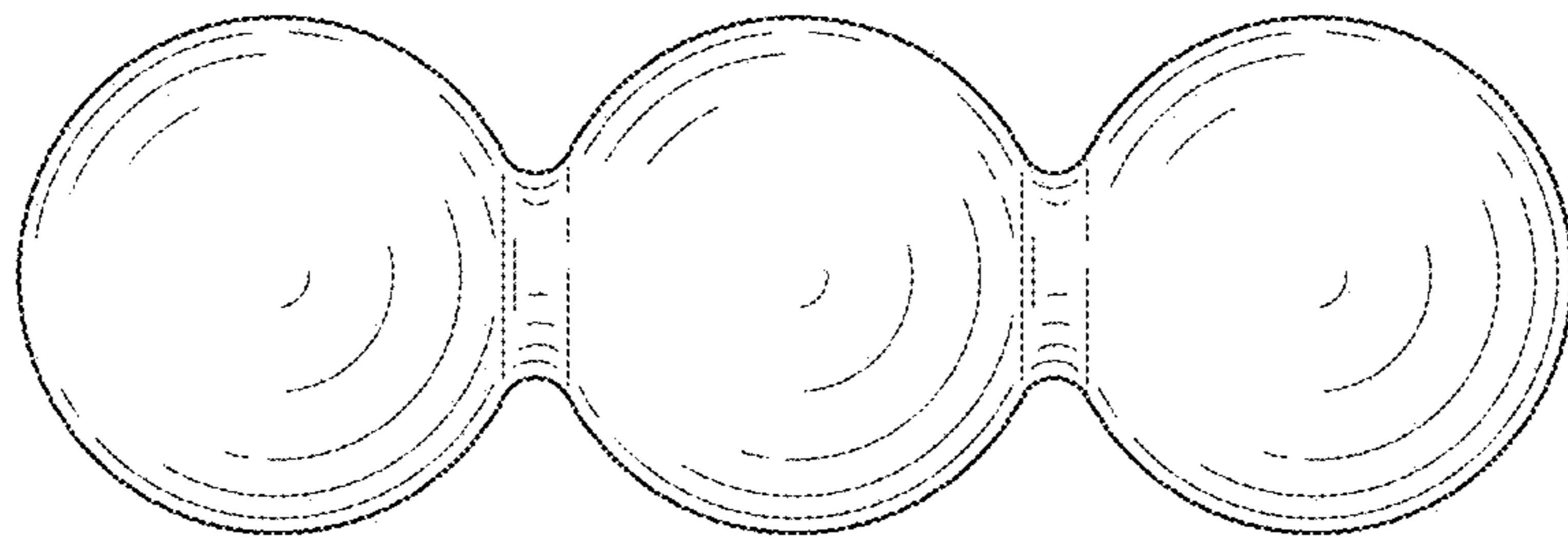

FIG. 10

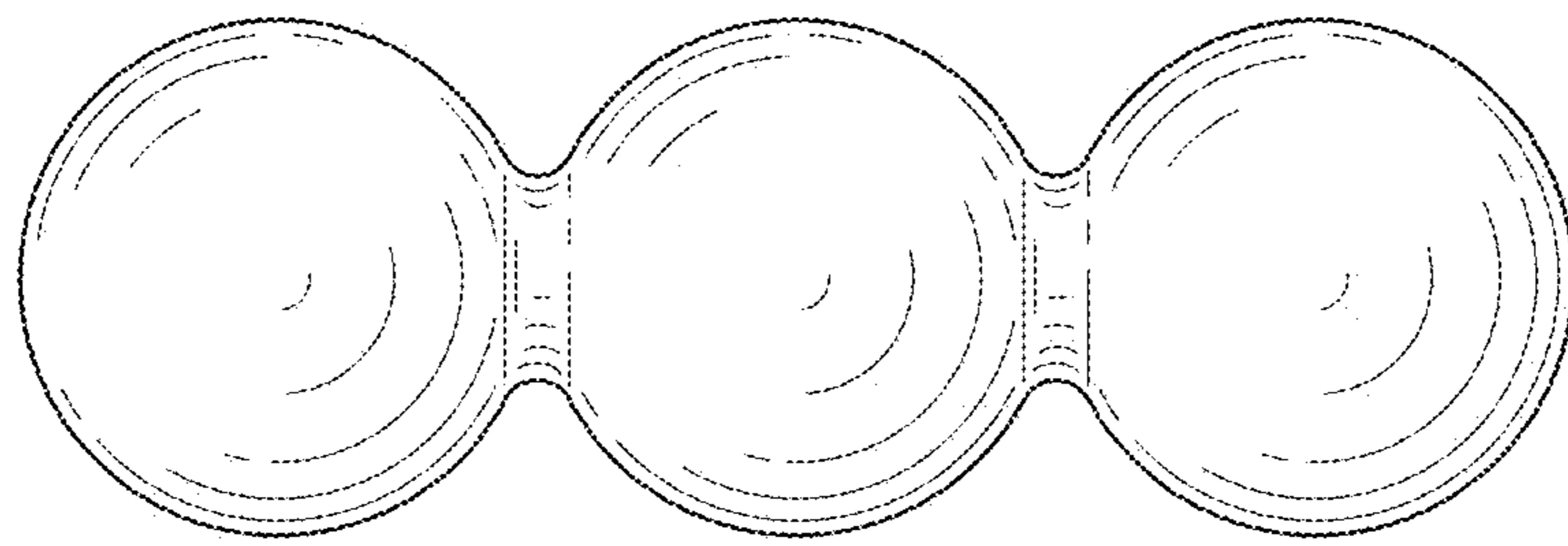

FIG. 11

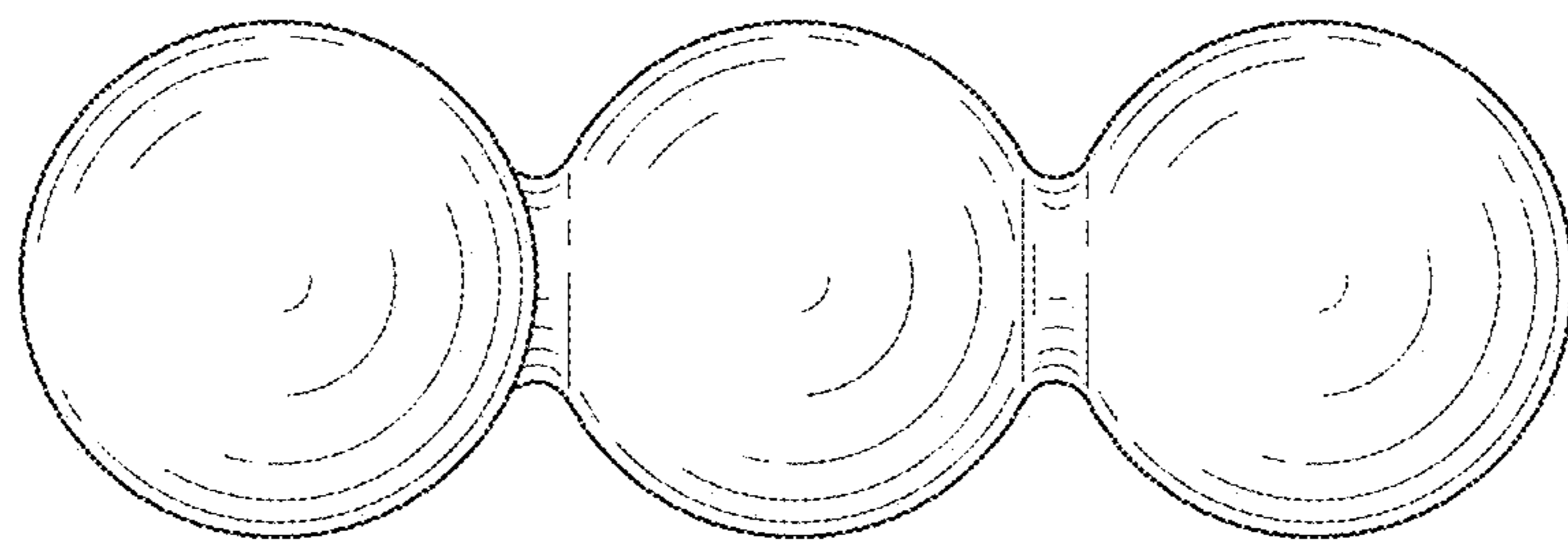

FIG. 12

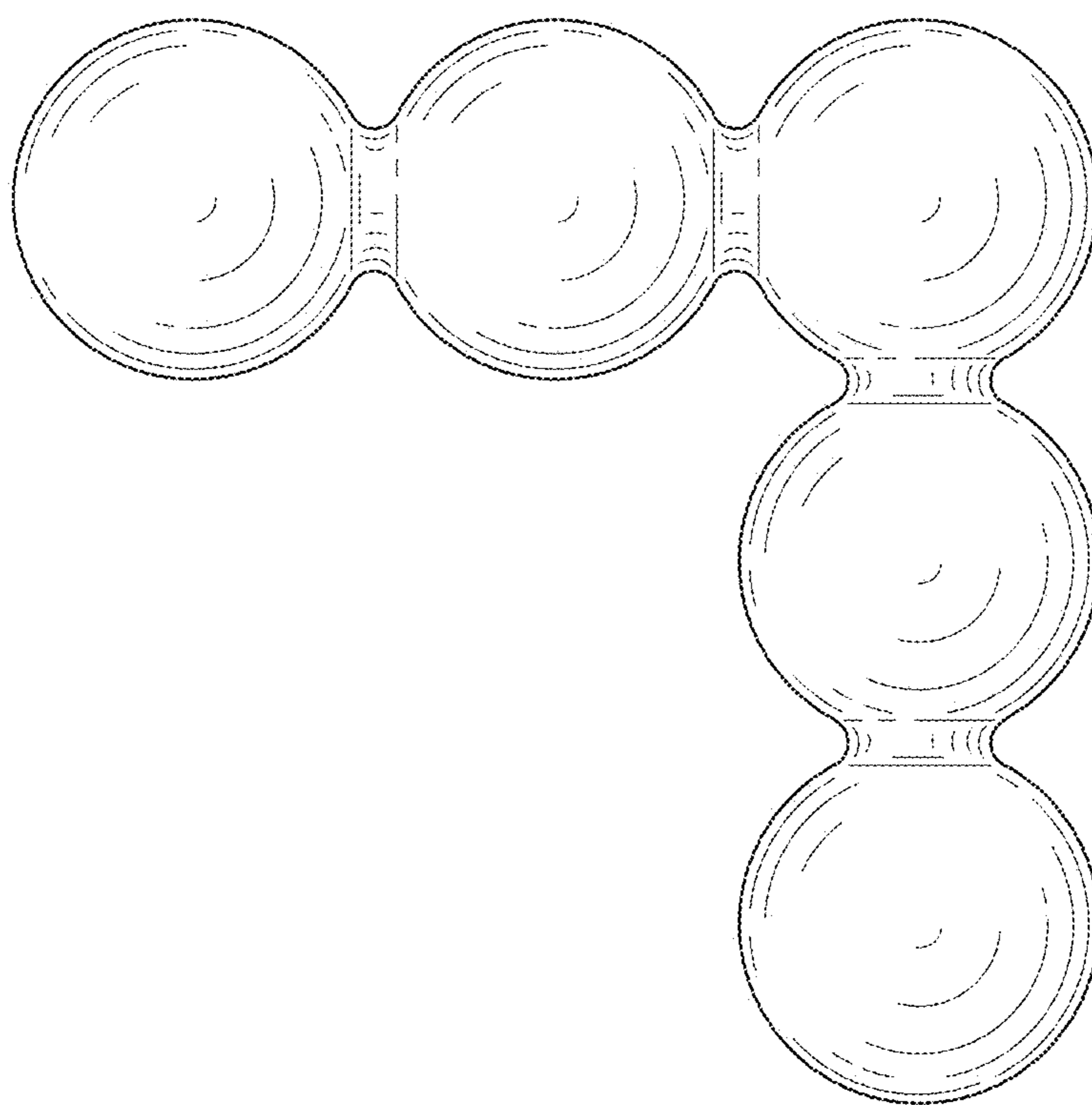

FIG. 13

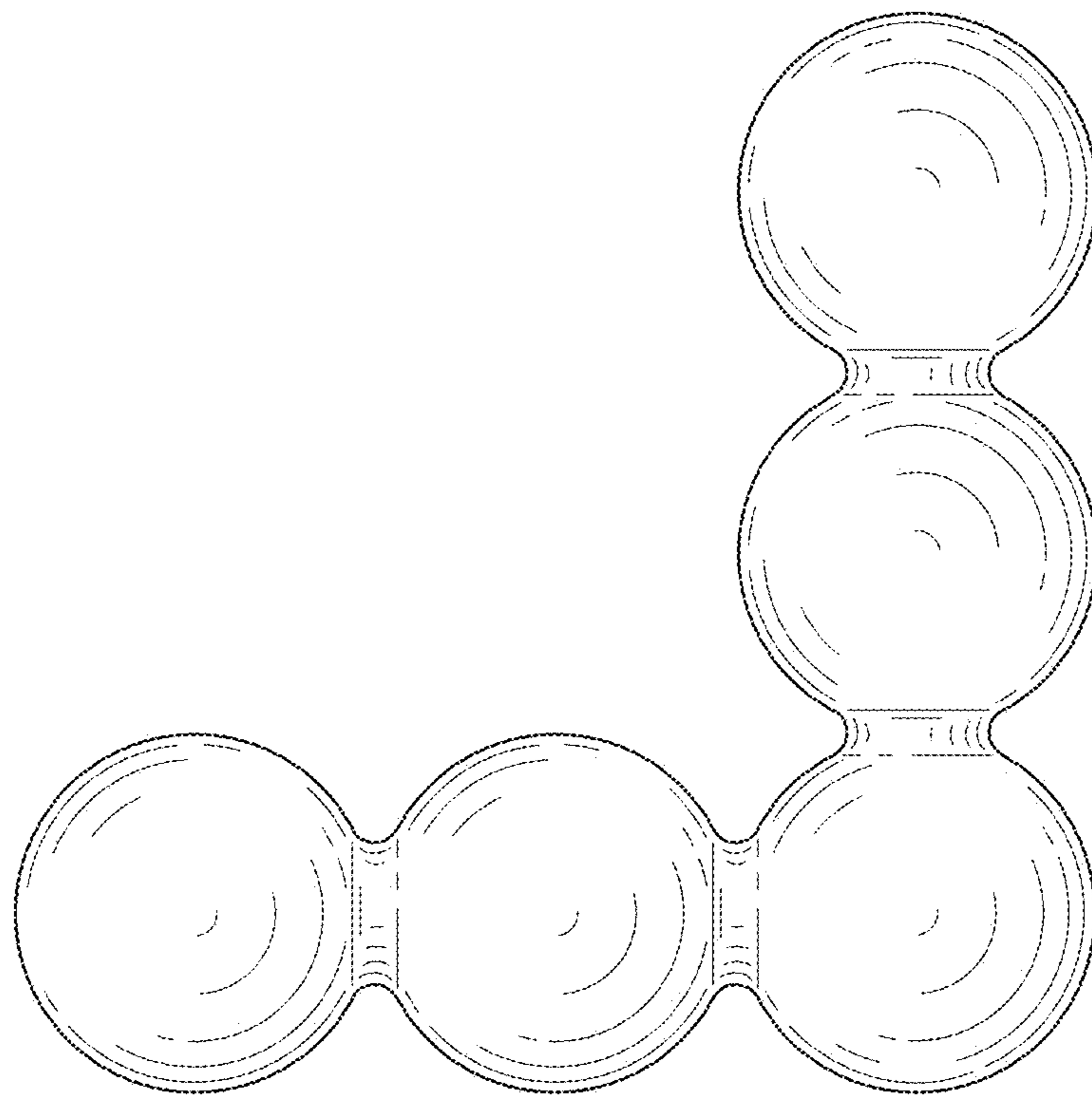

FIG. 14

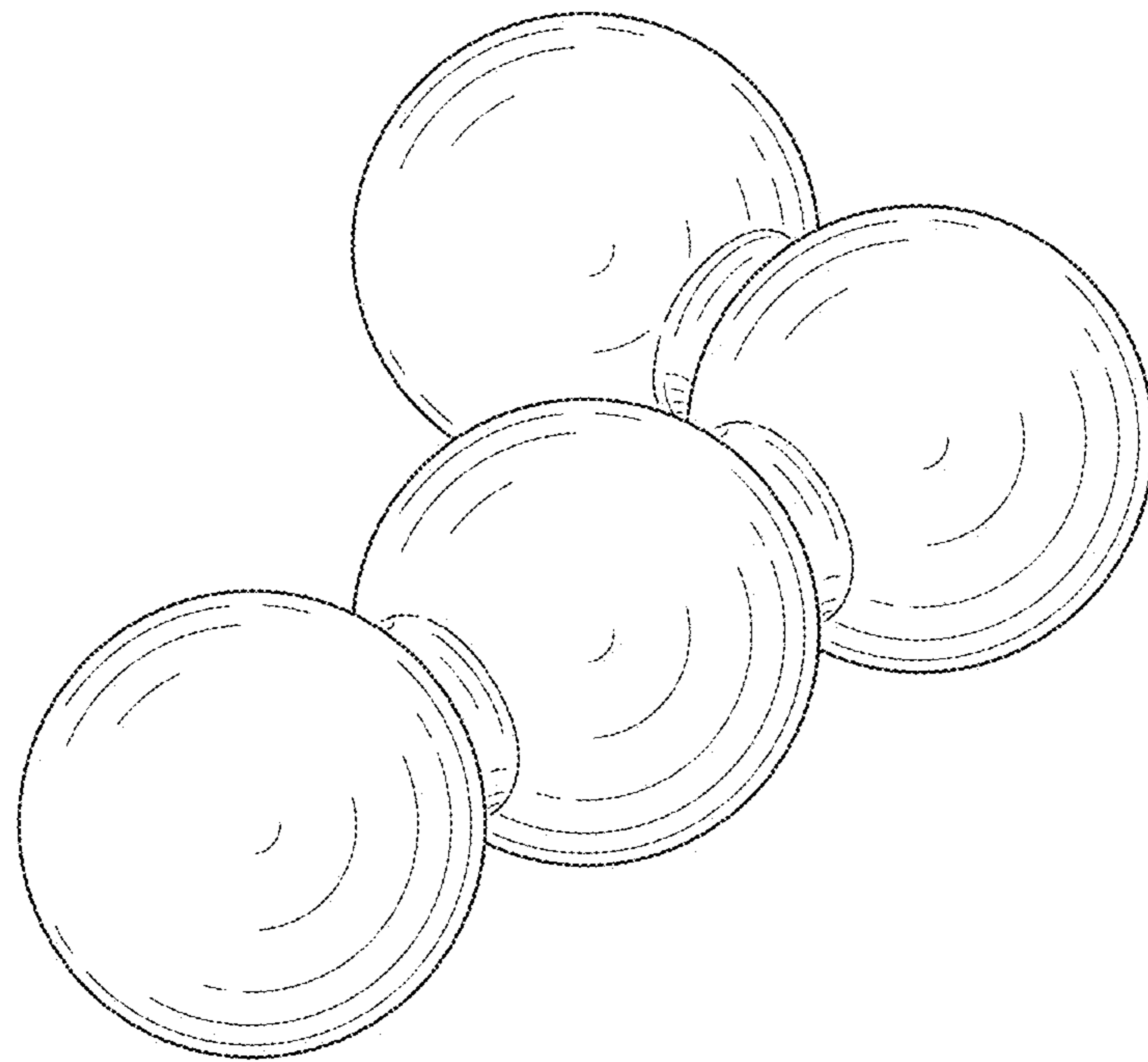

FIG. 15

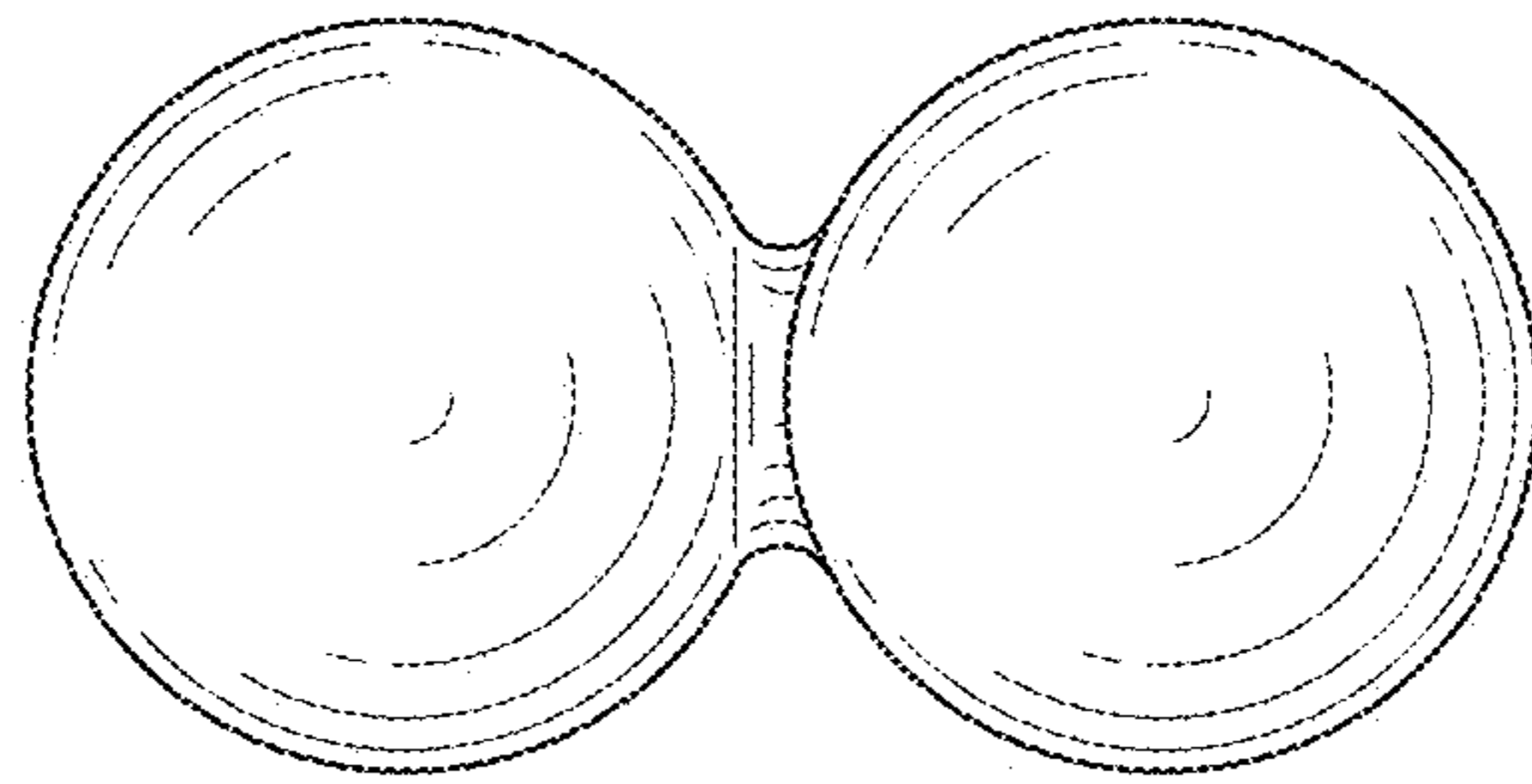

FIG. 16

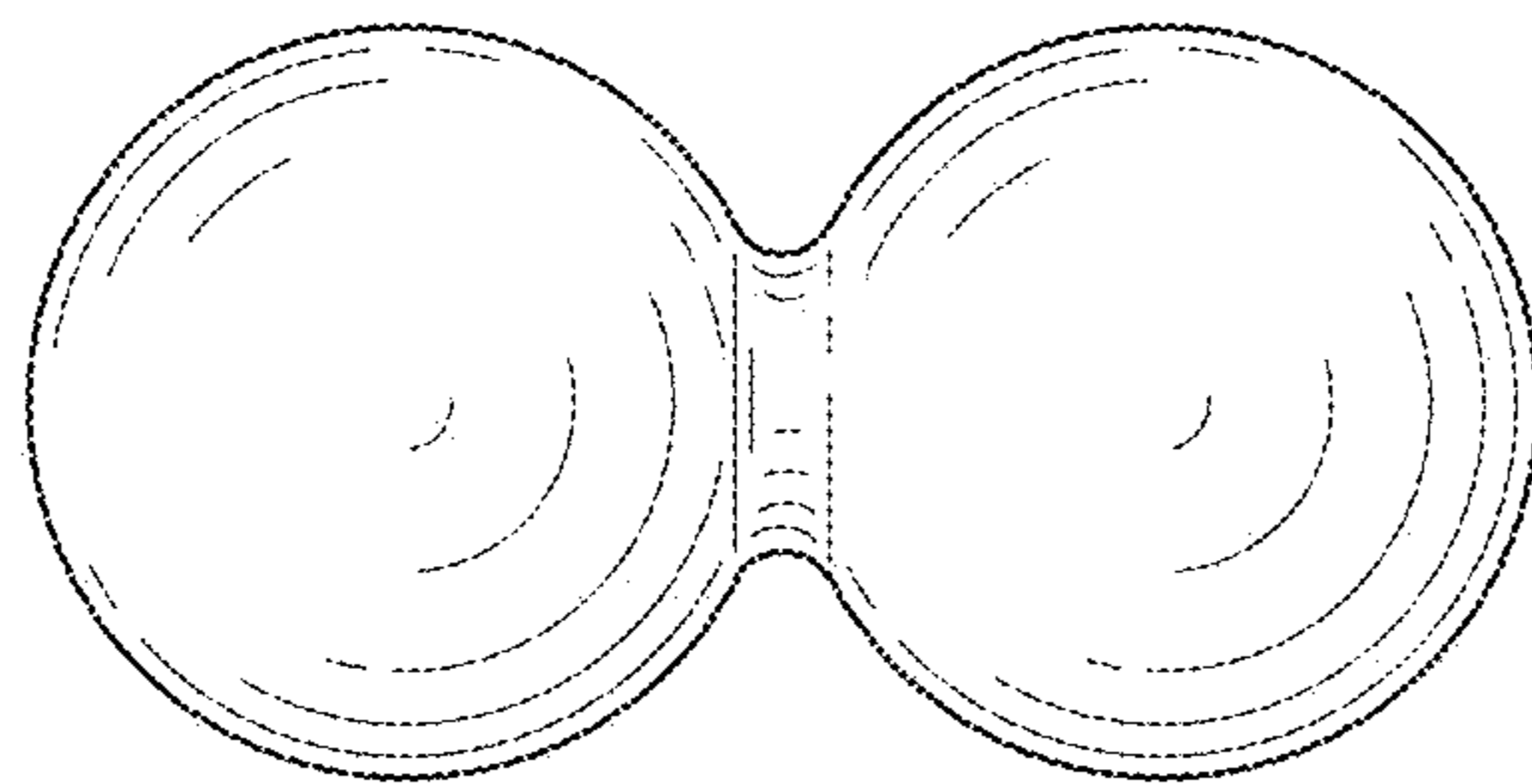

FIG. 17

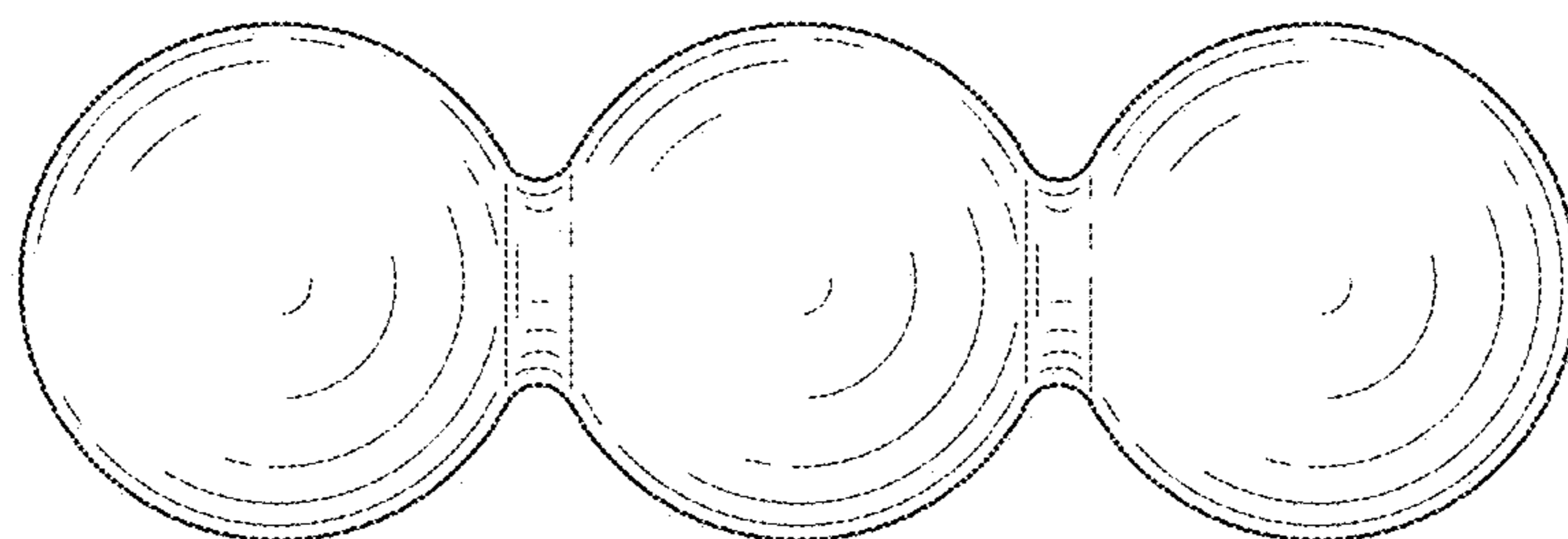

FIG. 18

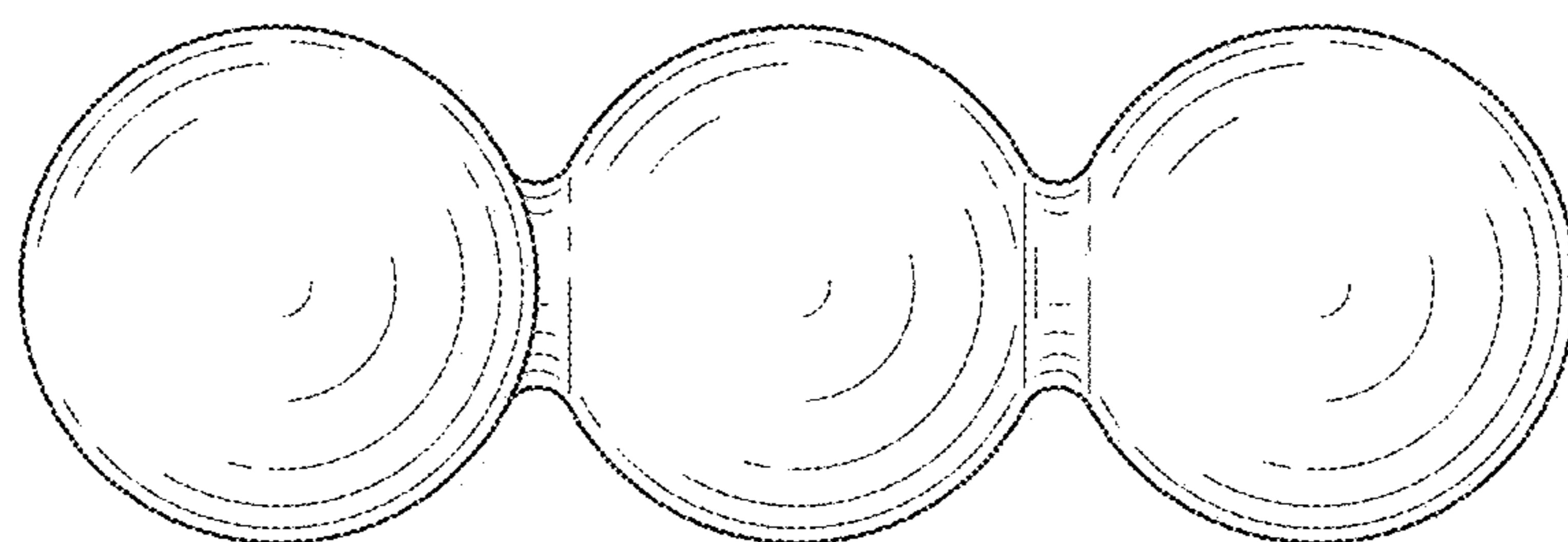

FIG. 19

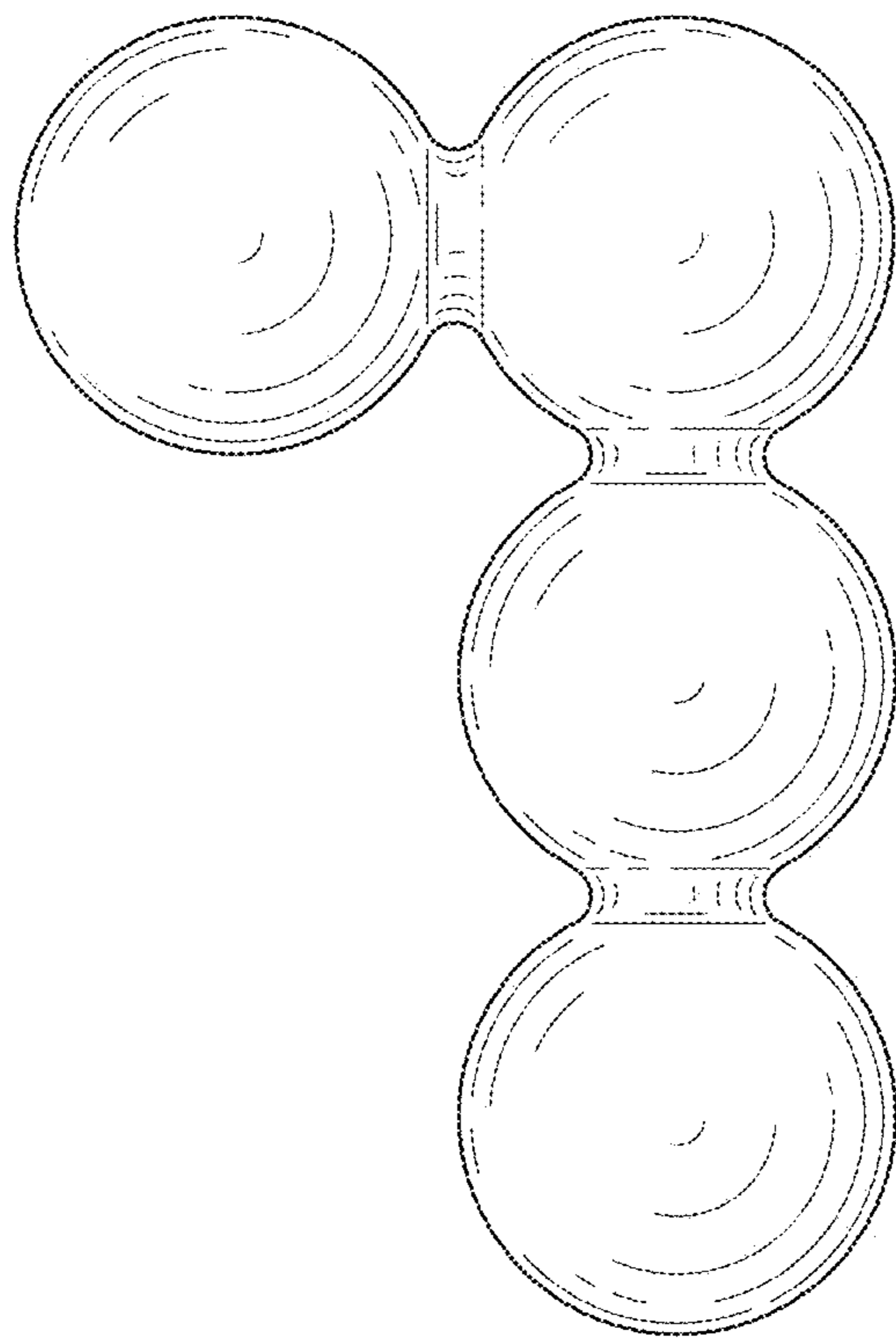

FIG. 20

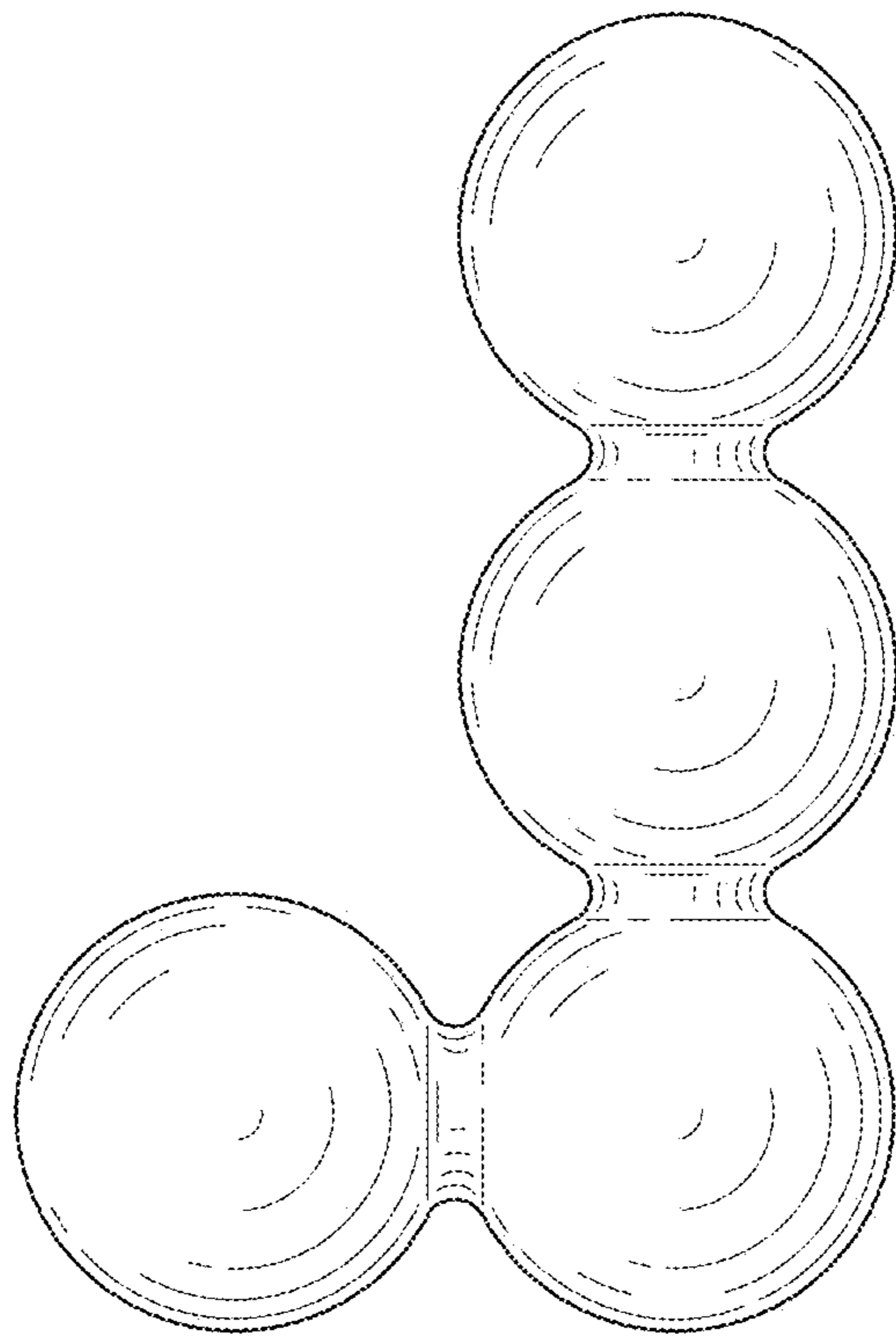

FIG. 21

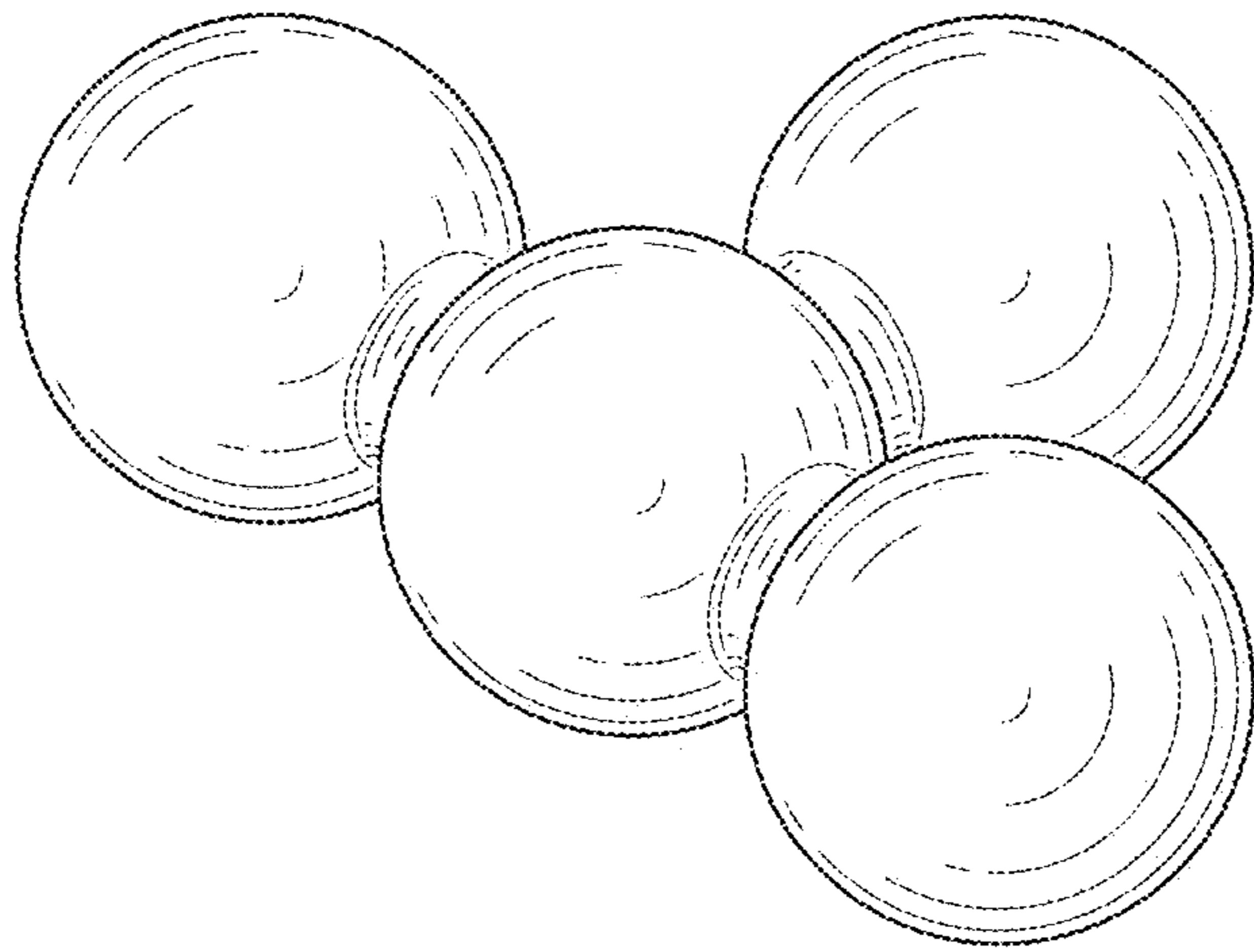

FIG. 22

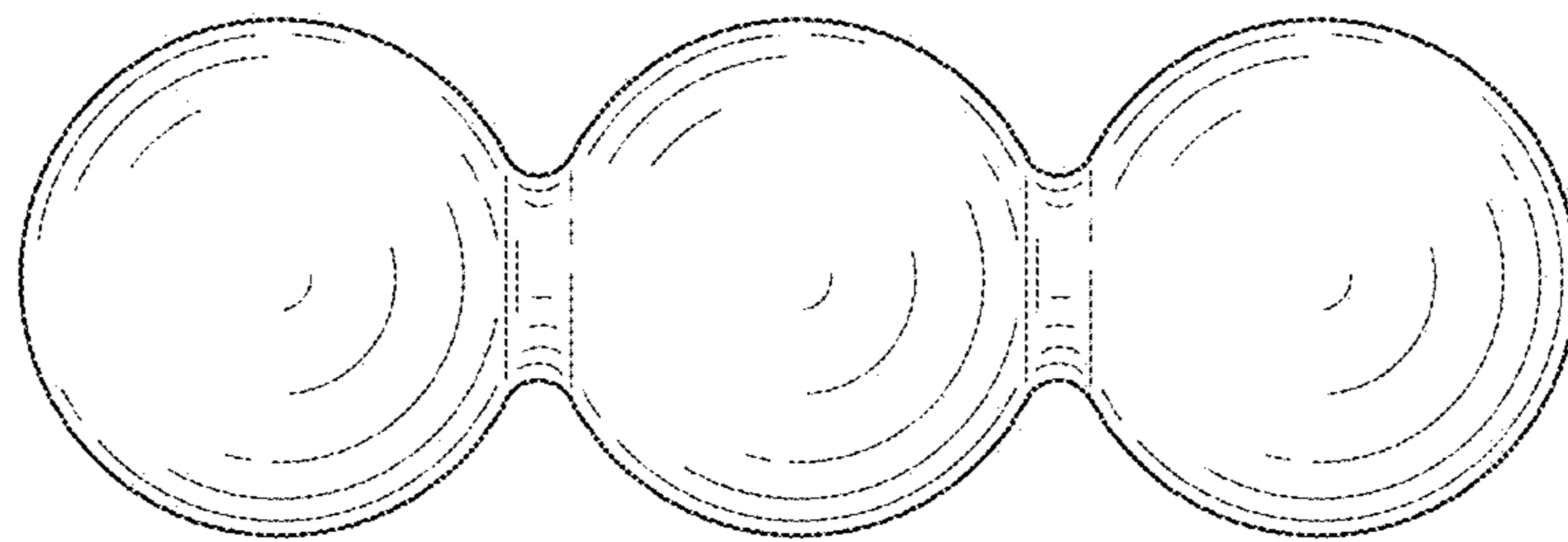

FIG. 23

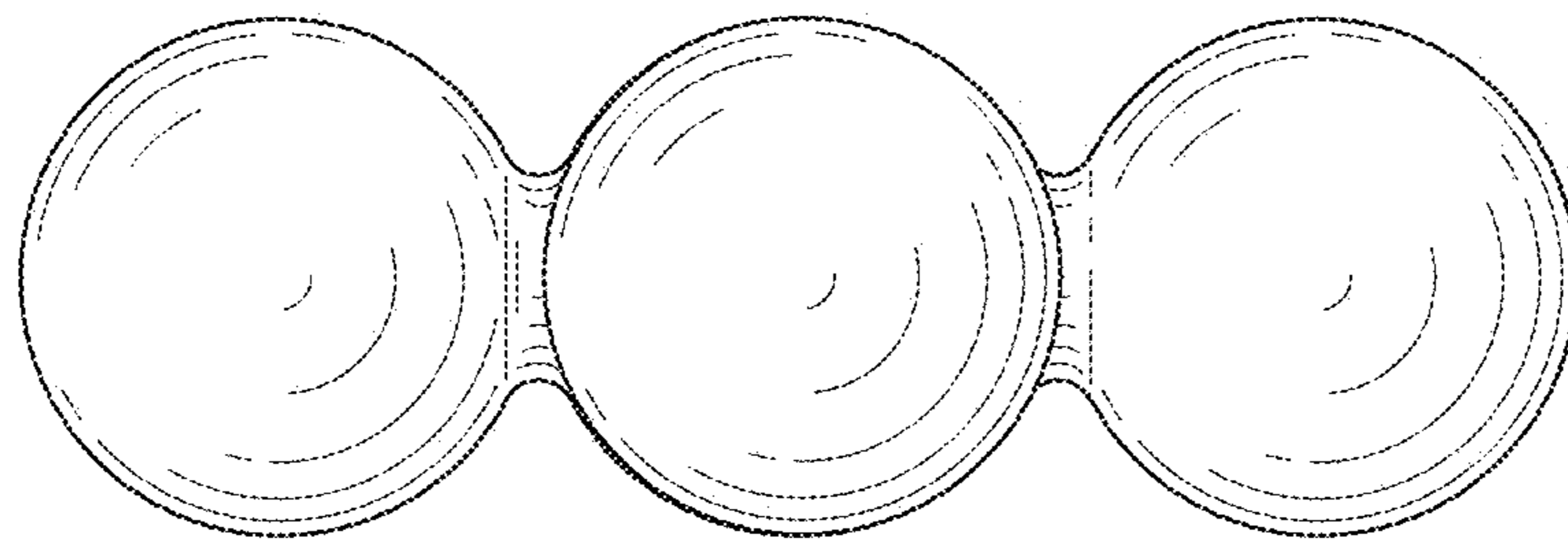

FIG. 24

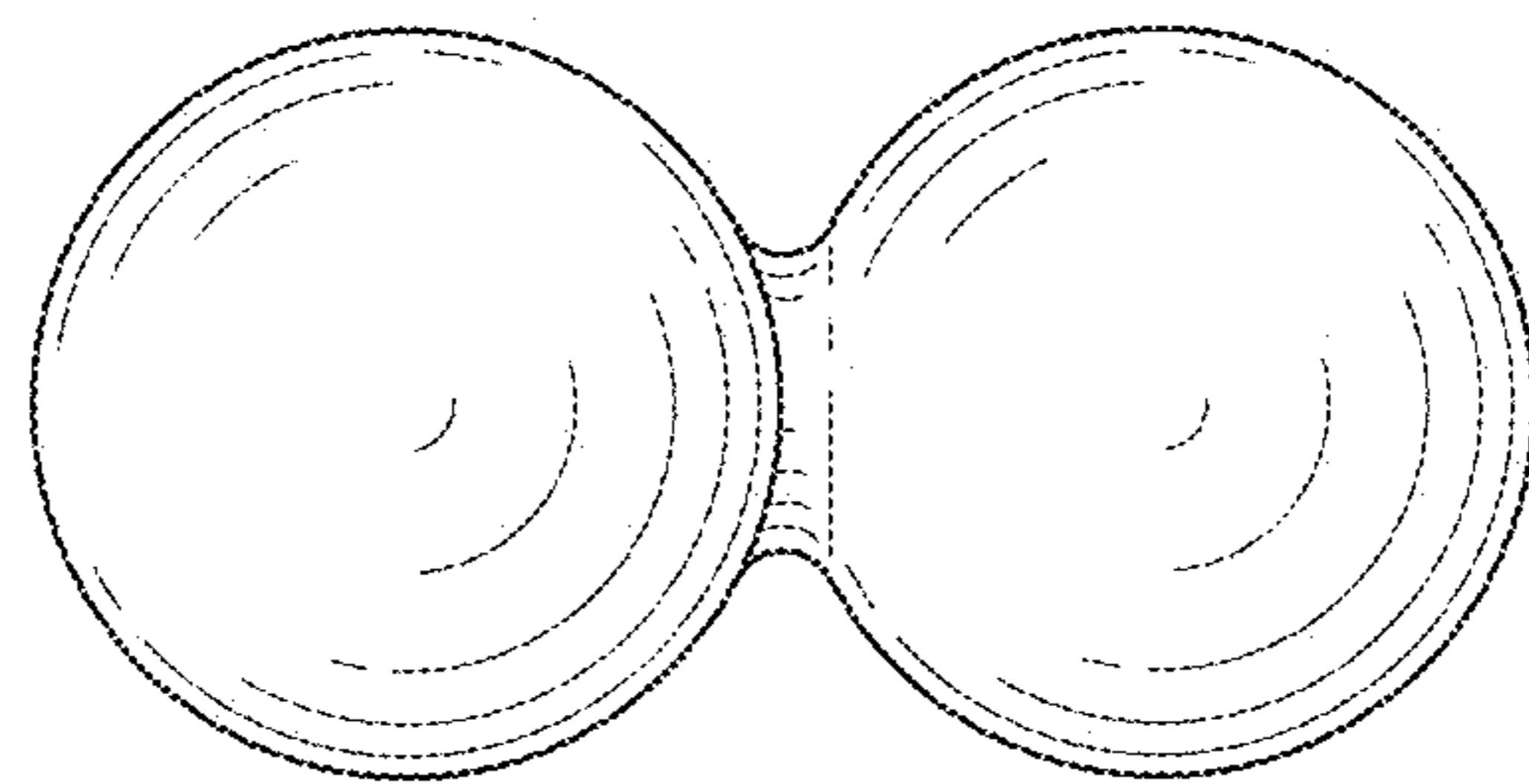

FIG. 25

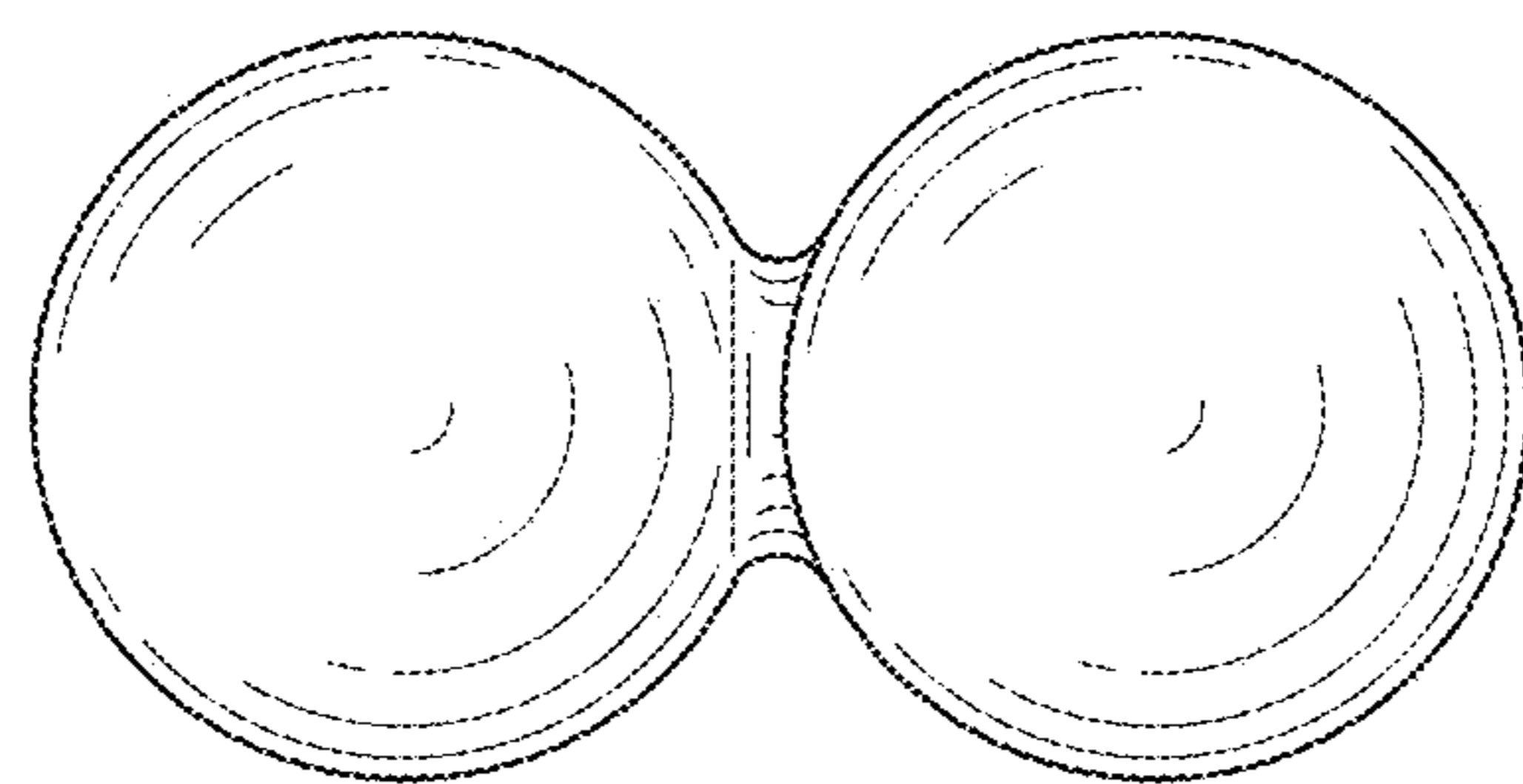

FIG. 26

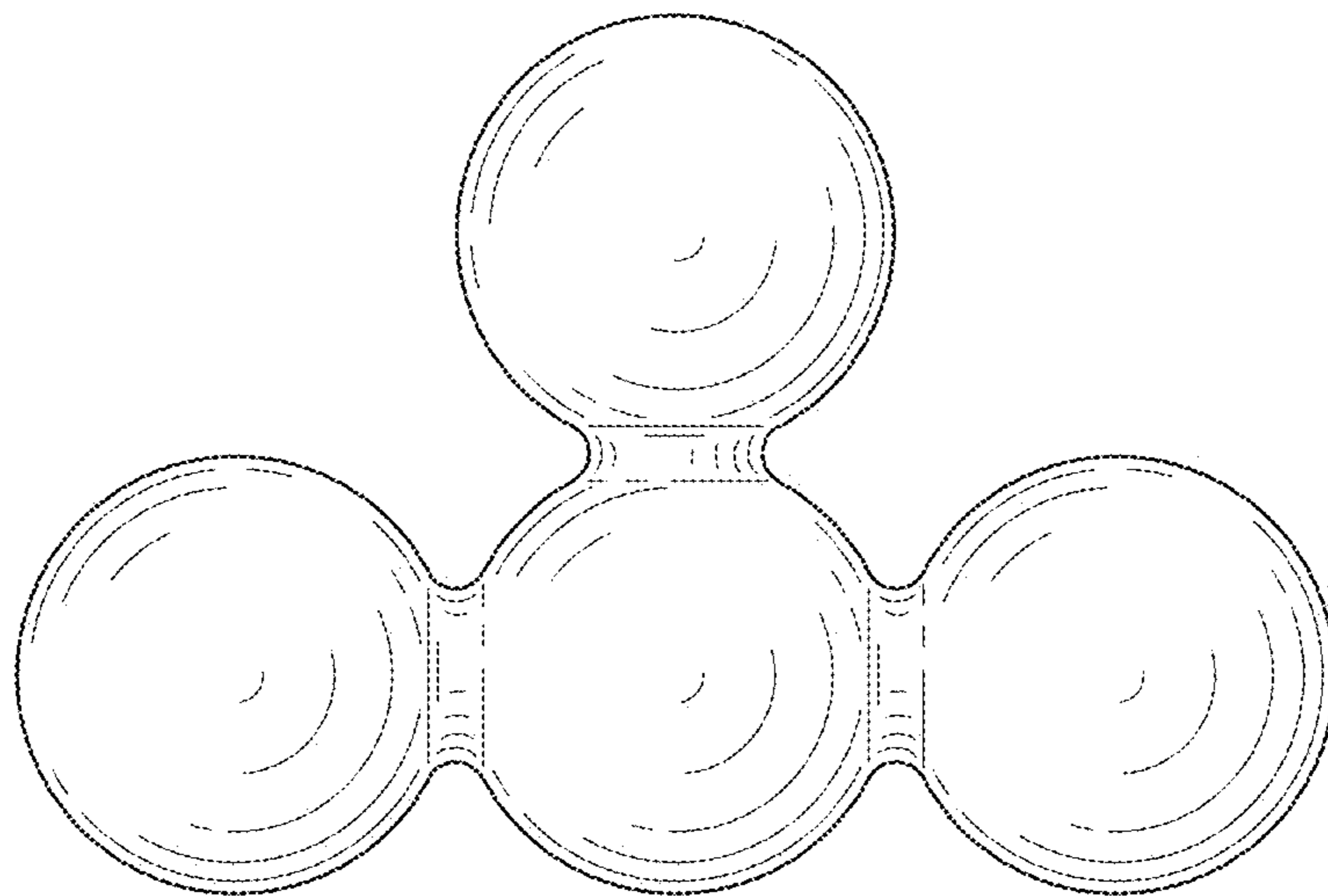

FIG. 27

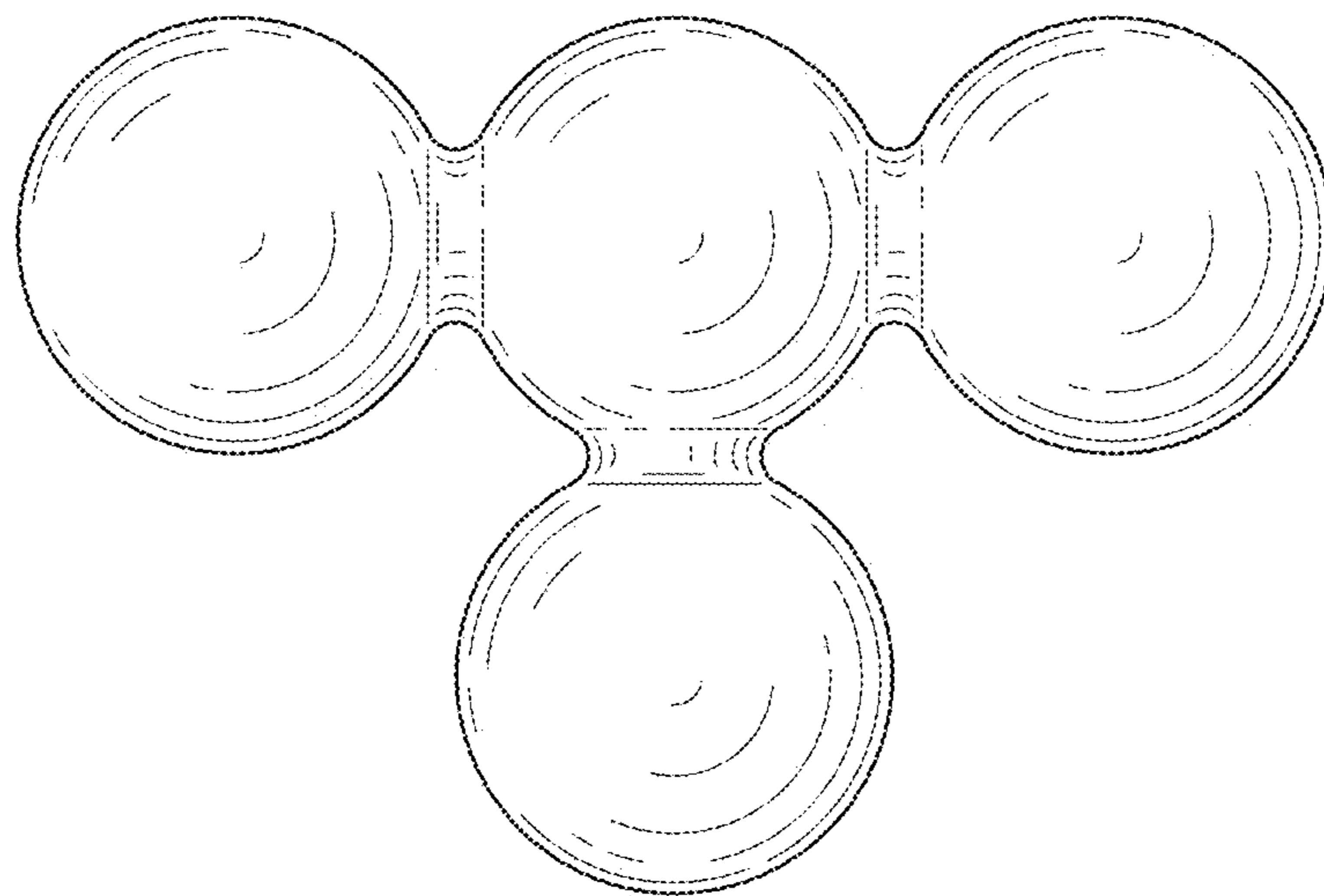

FIG. 28

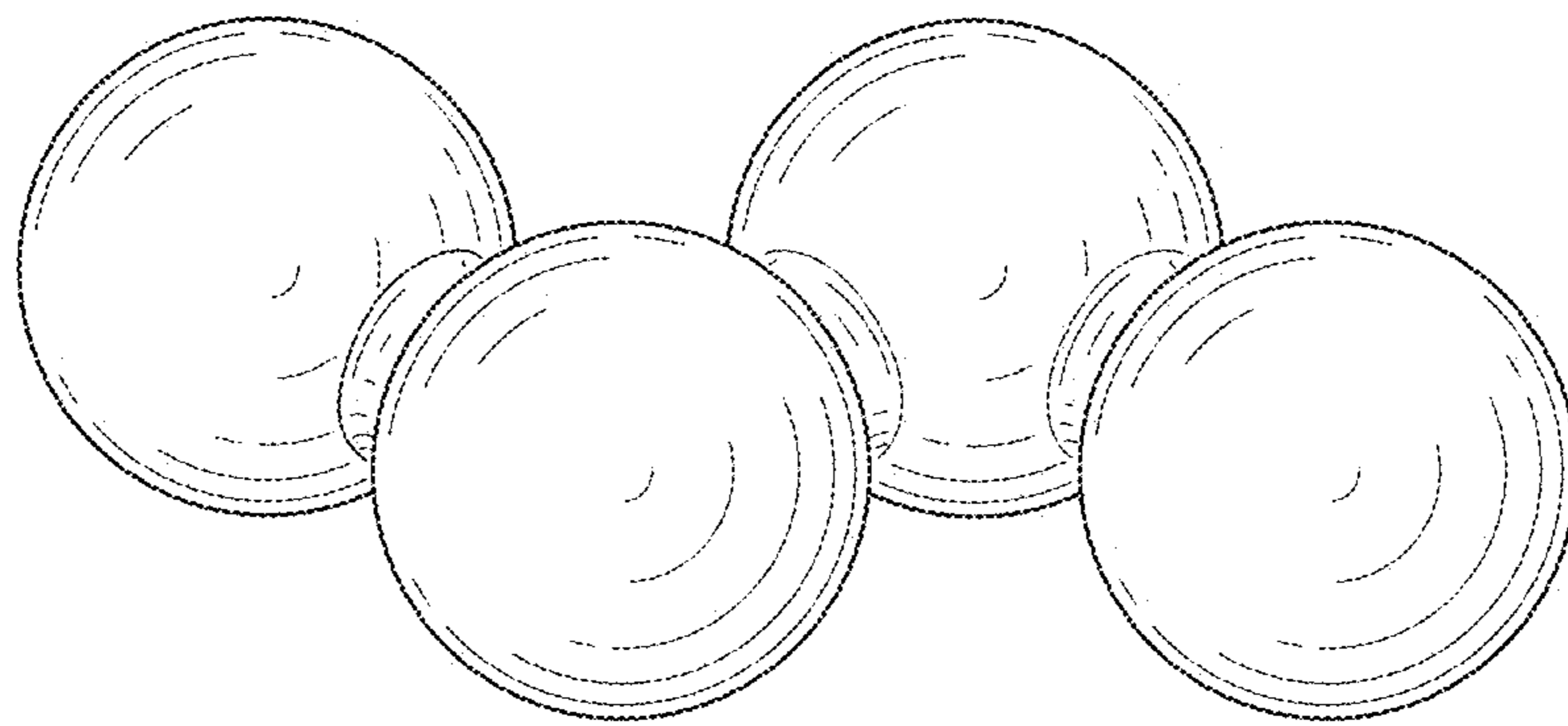

FIG. 29

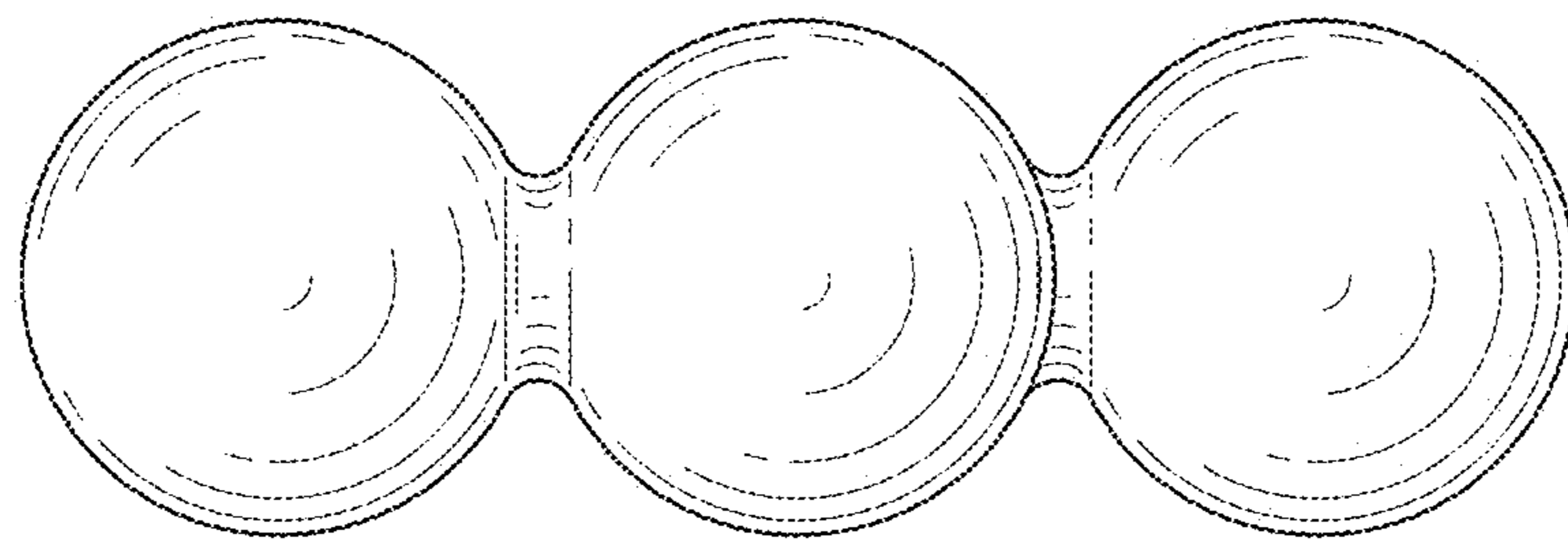

FIG. 30

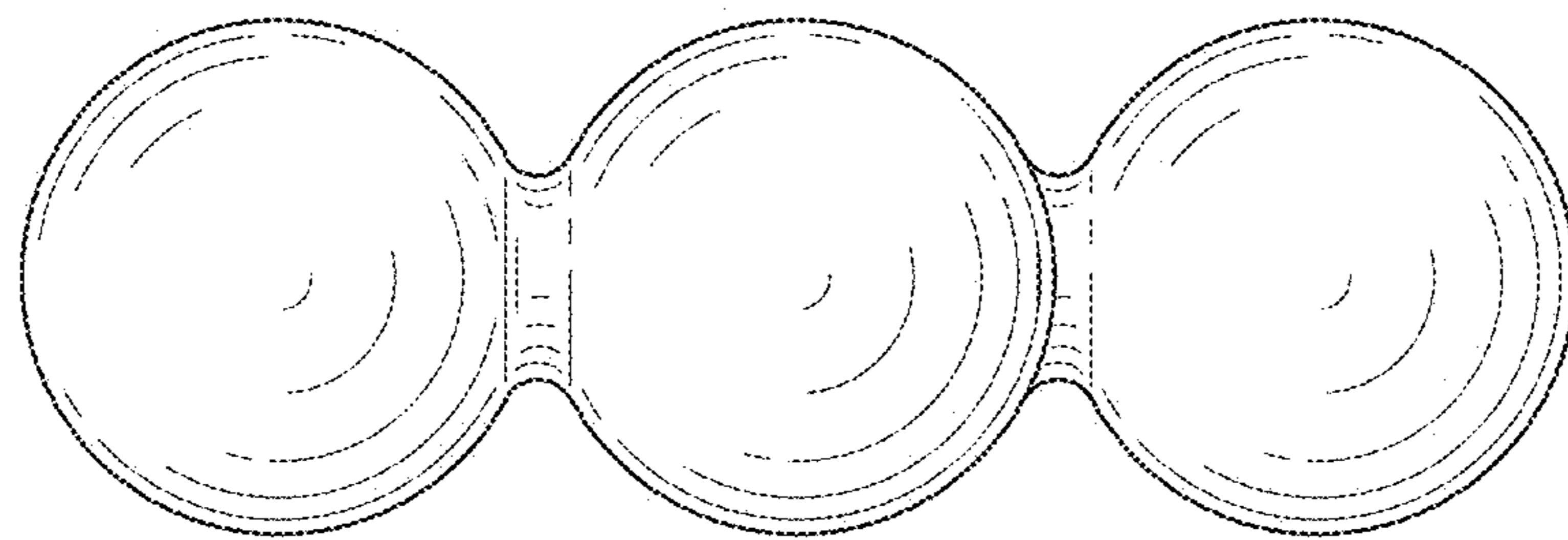

FIG. 31

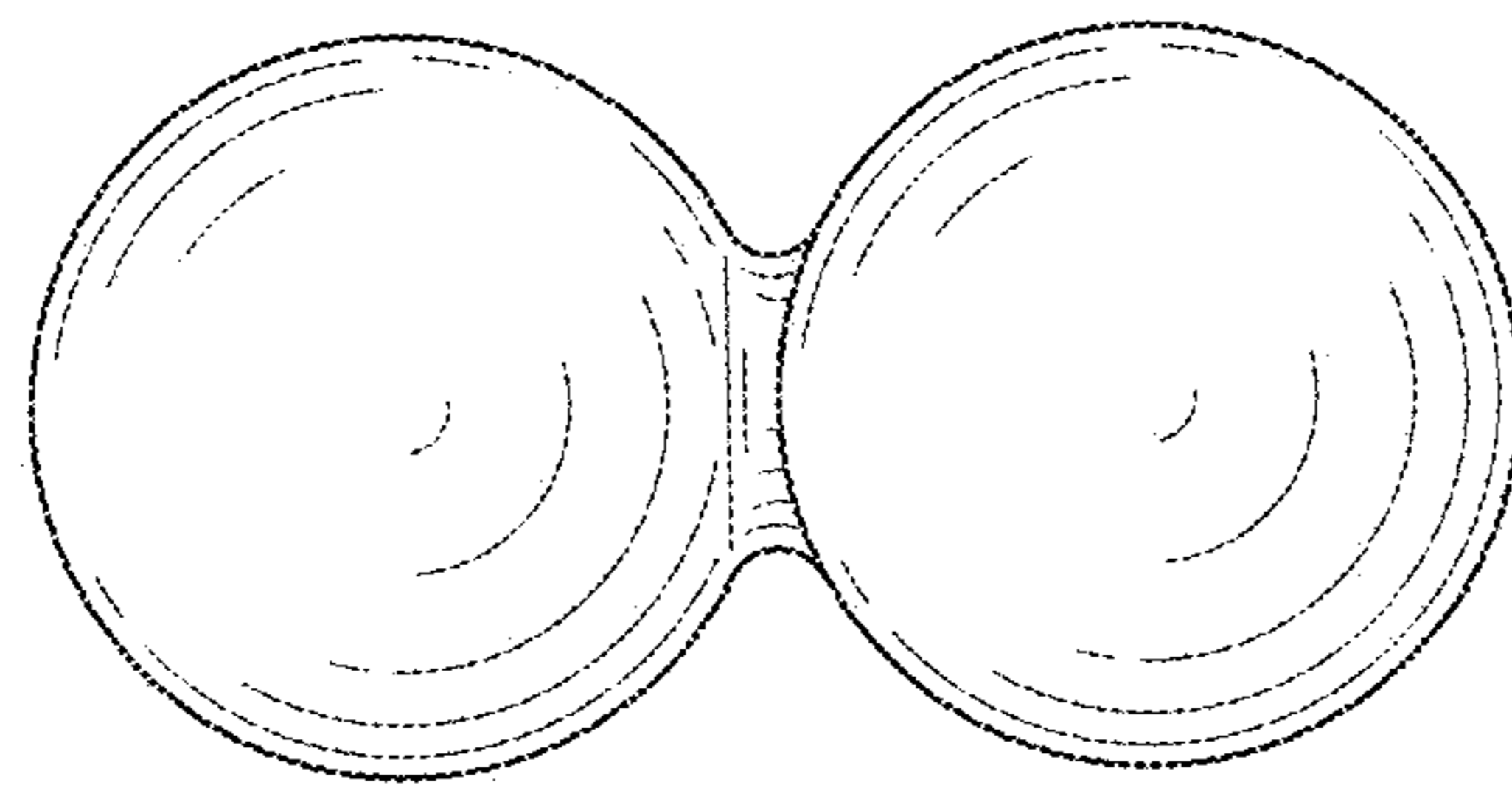

FIG. 32

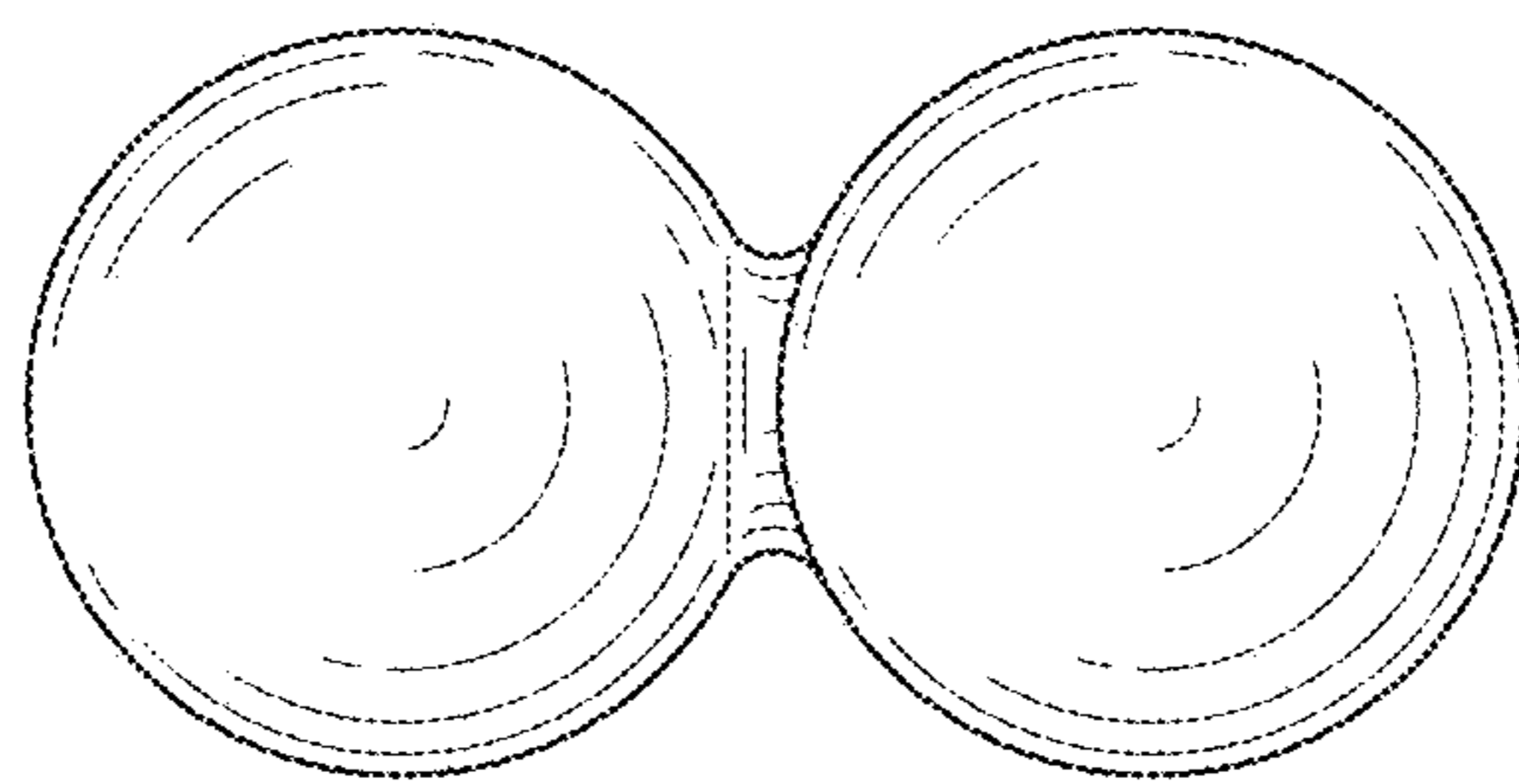

FIG. 33

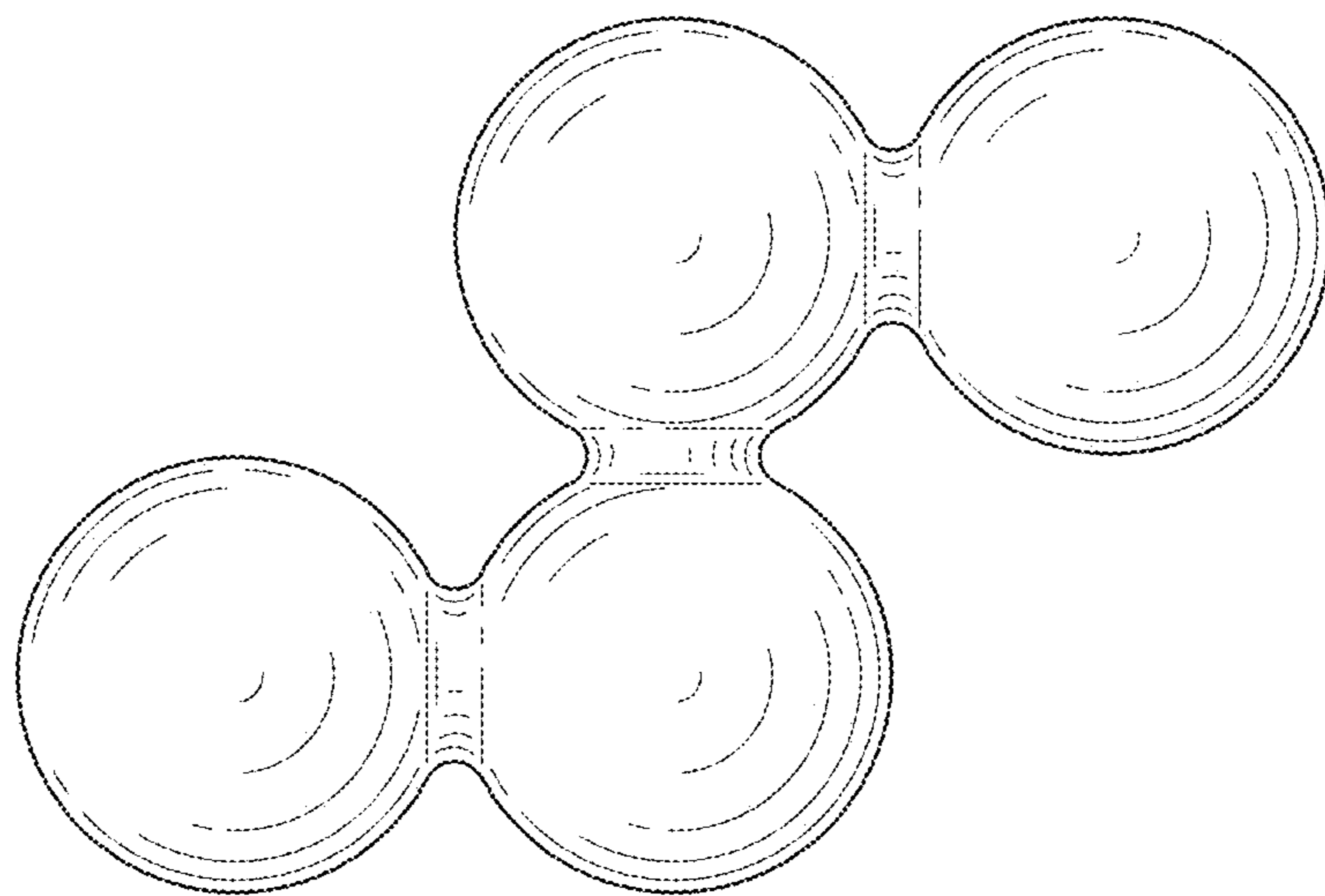

FIG. 34

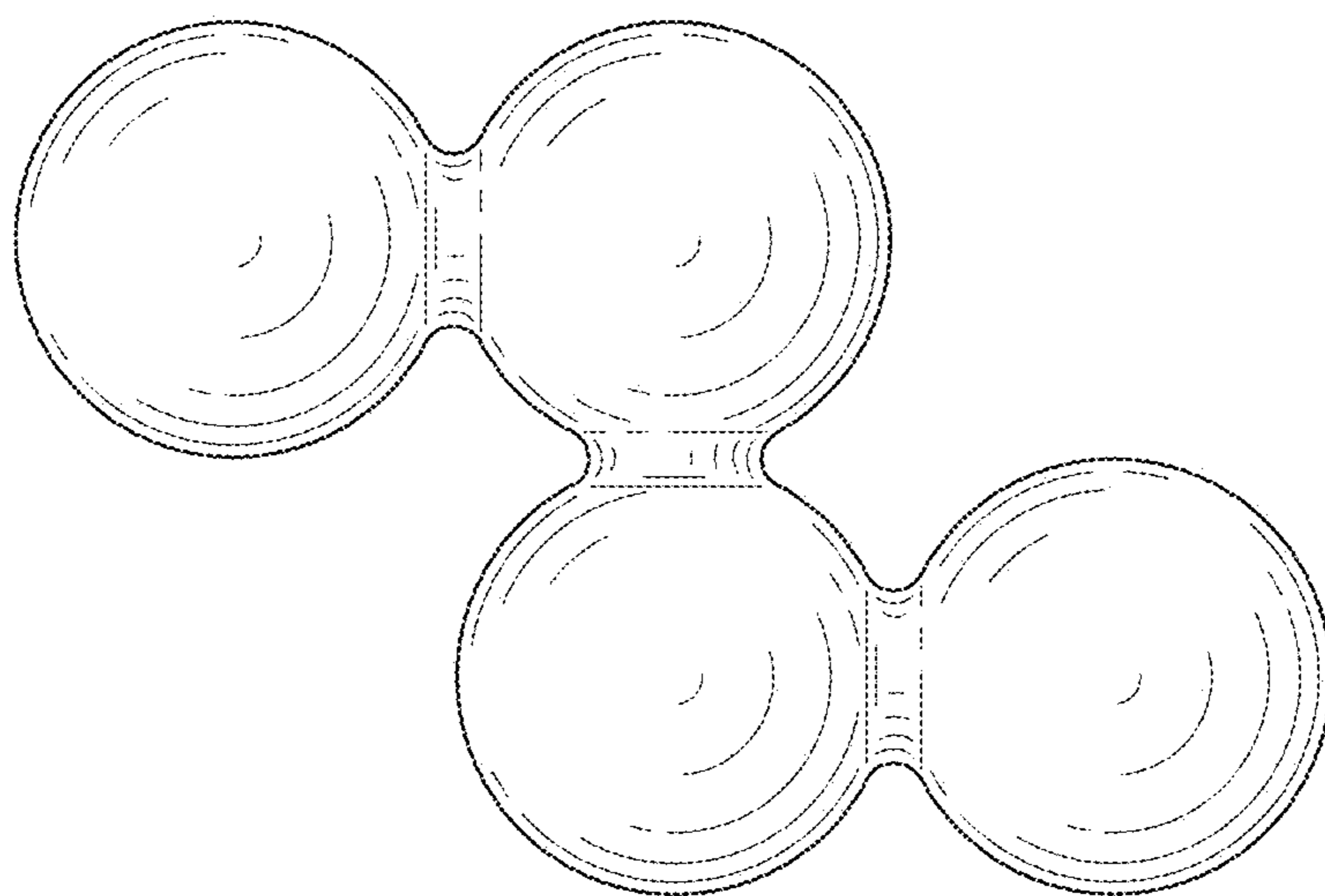

FIG. 35

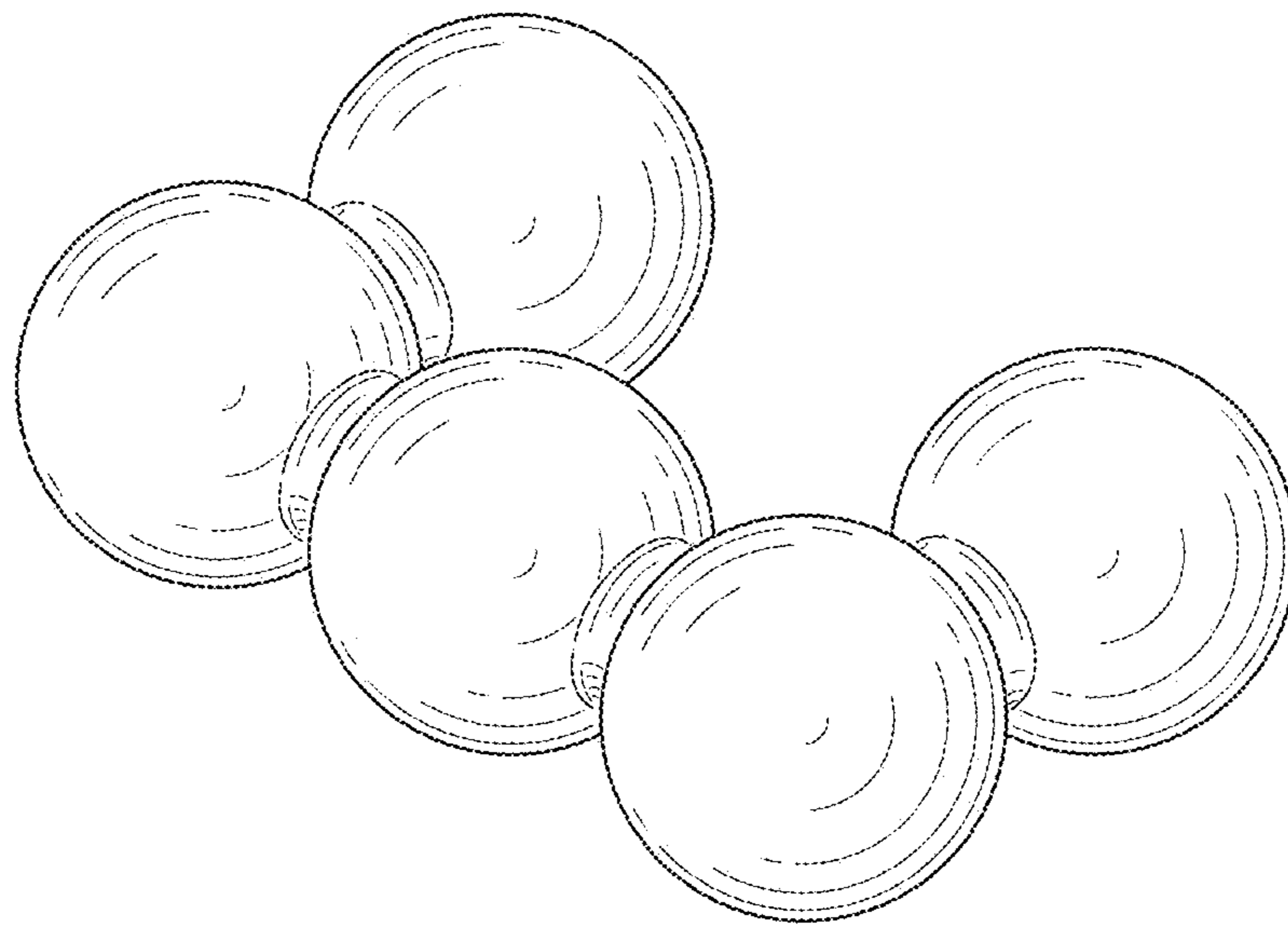

FIG. 36

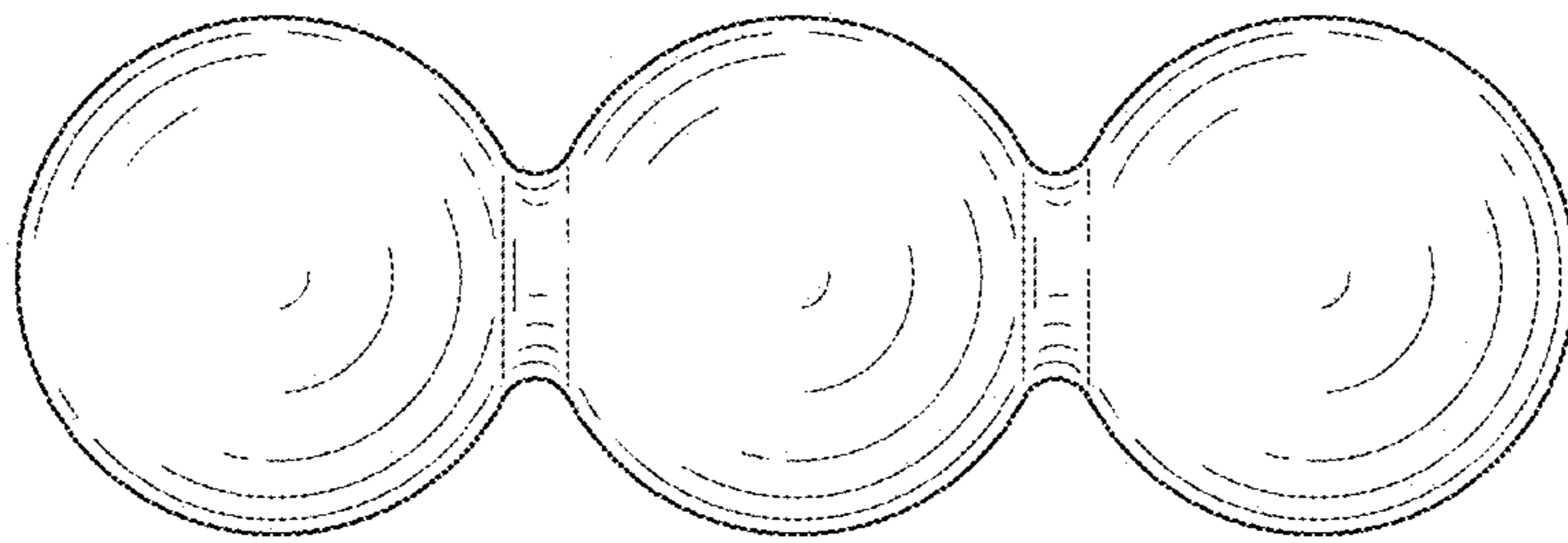

FIG. 37

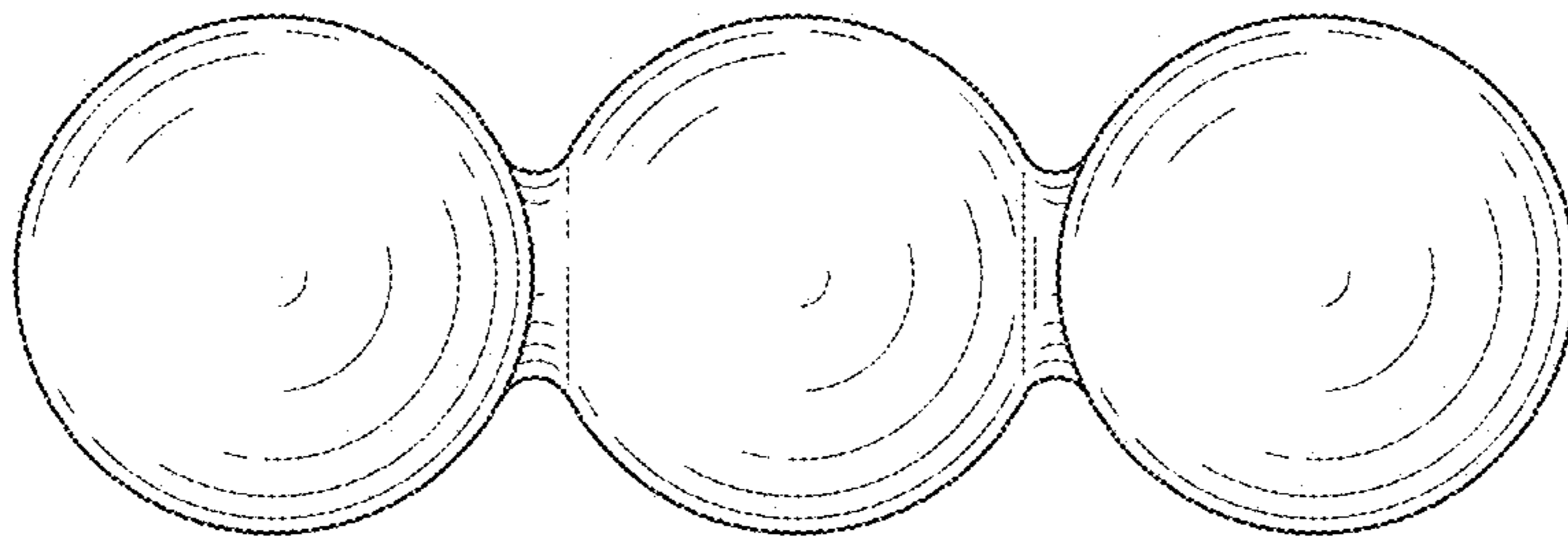

FIG. 38

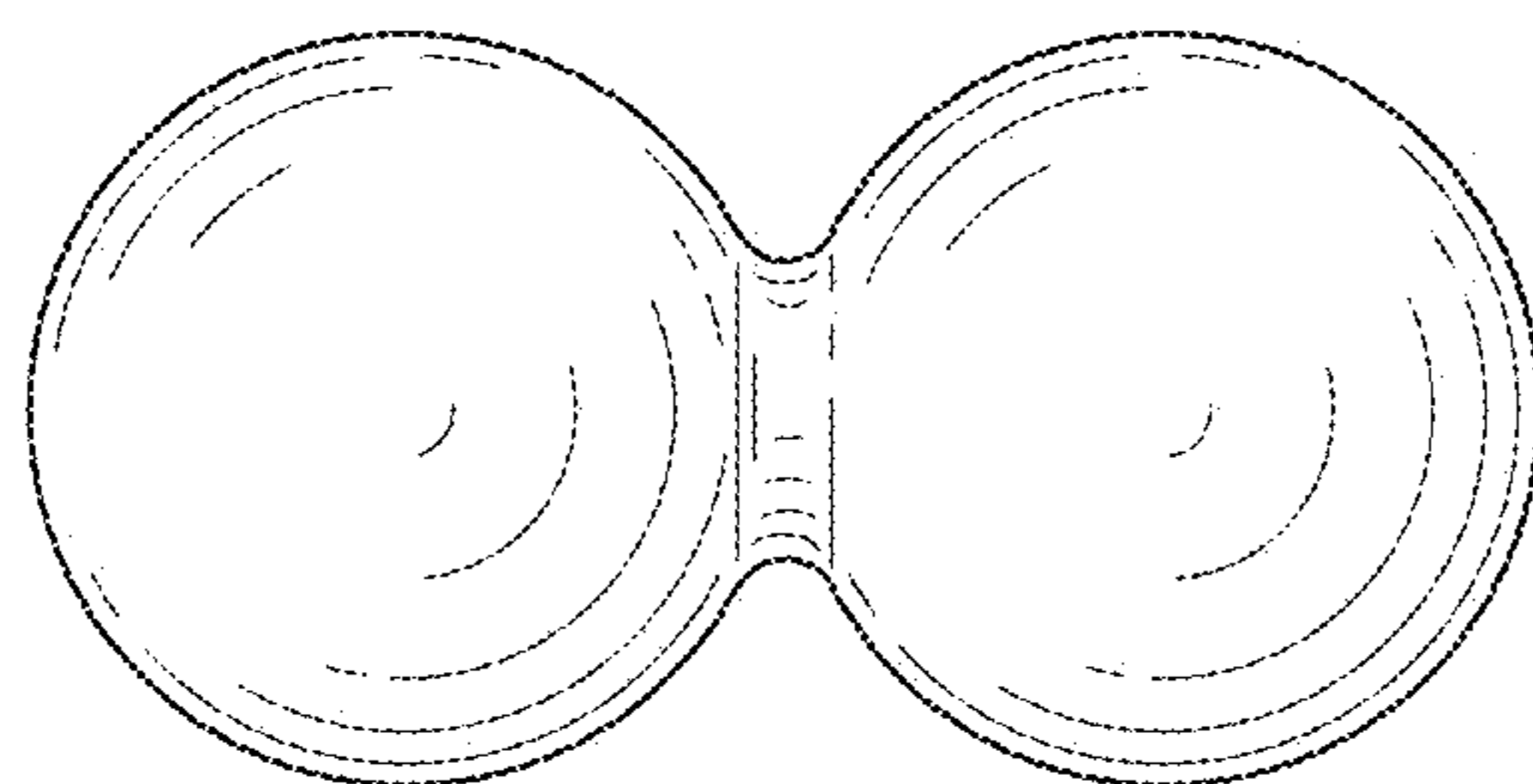

FIG. 39

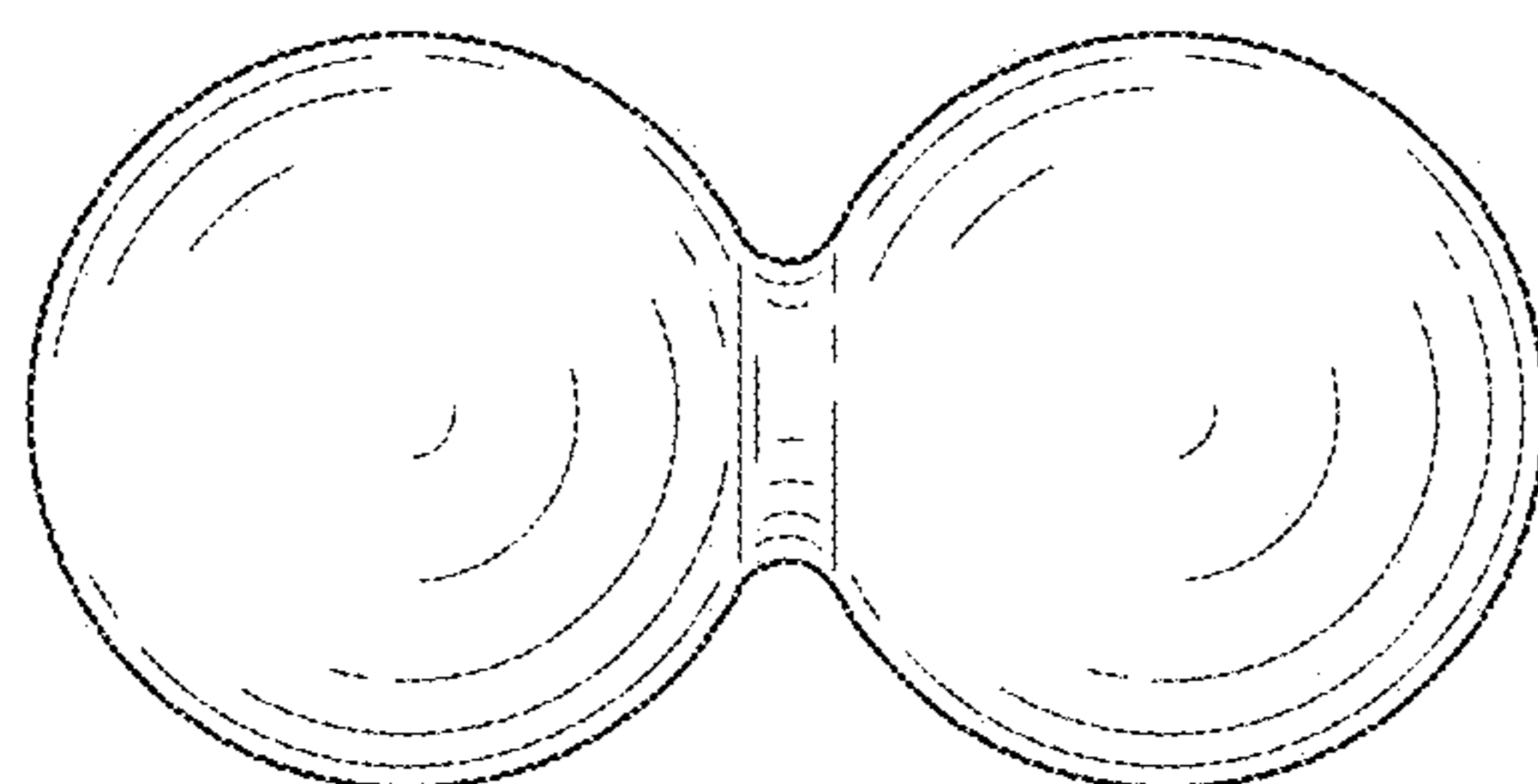

FIG. 40

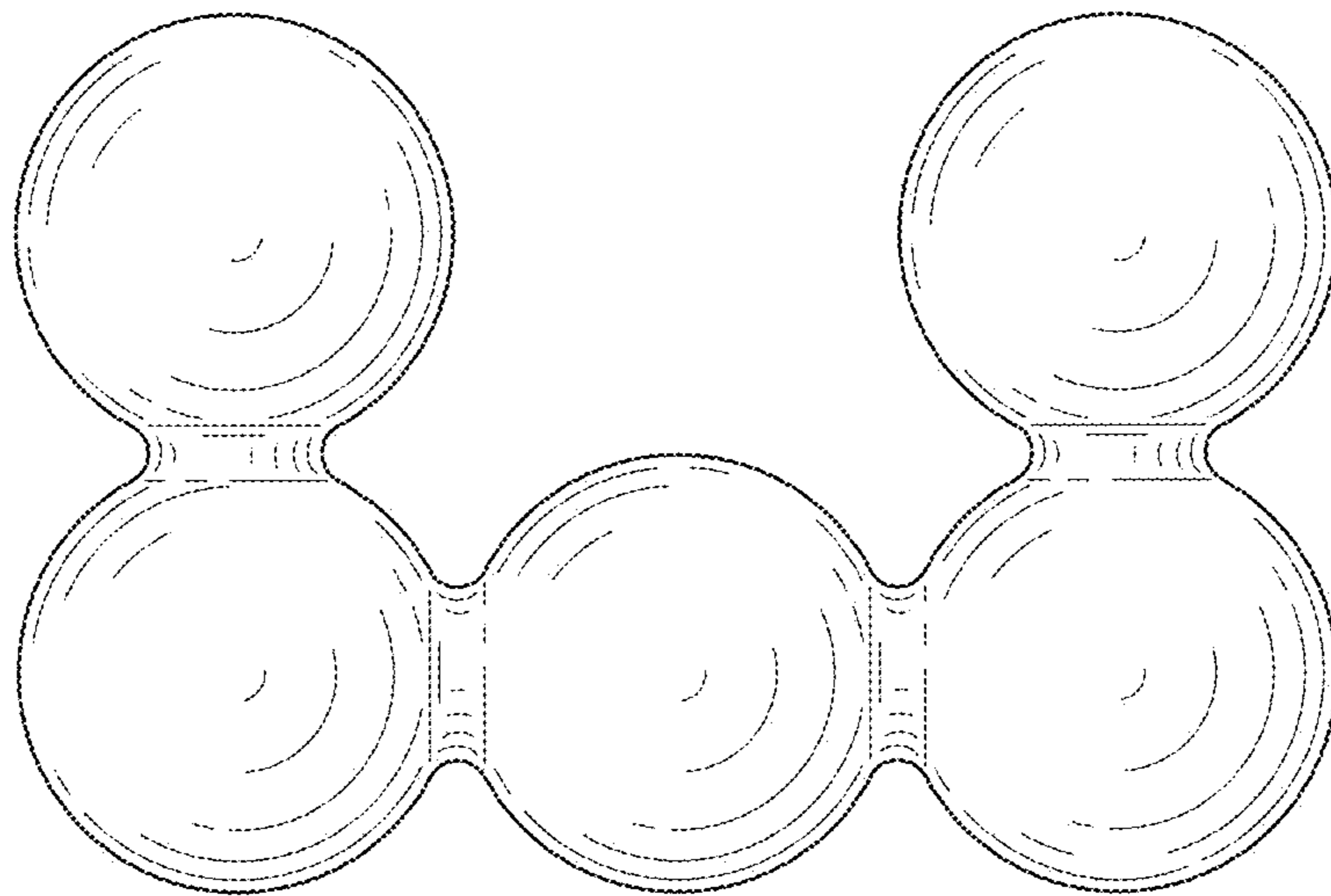

FIG. 41

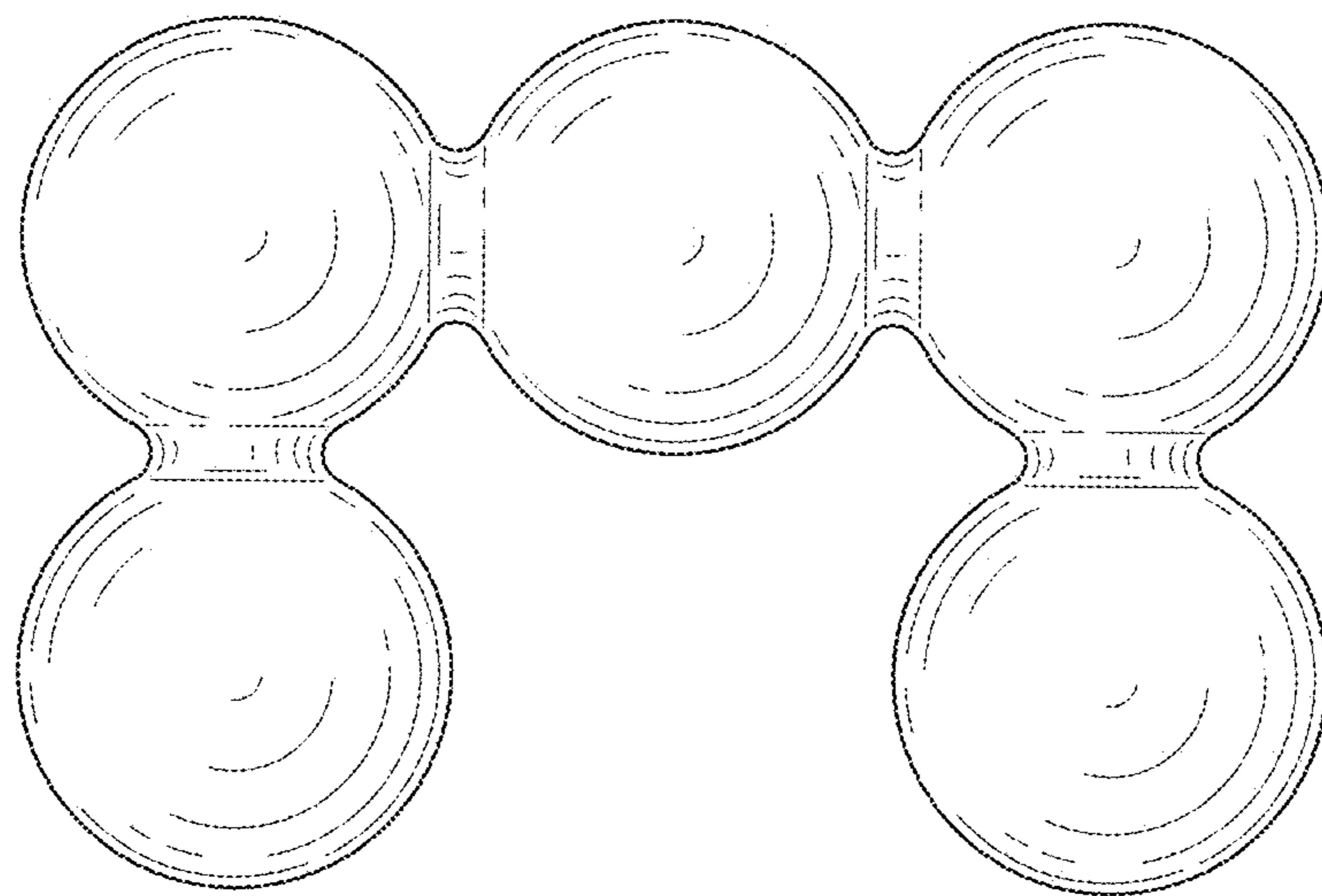

FIG. 42

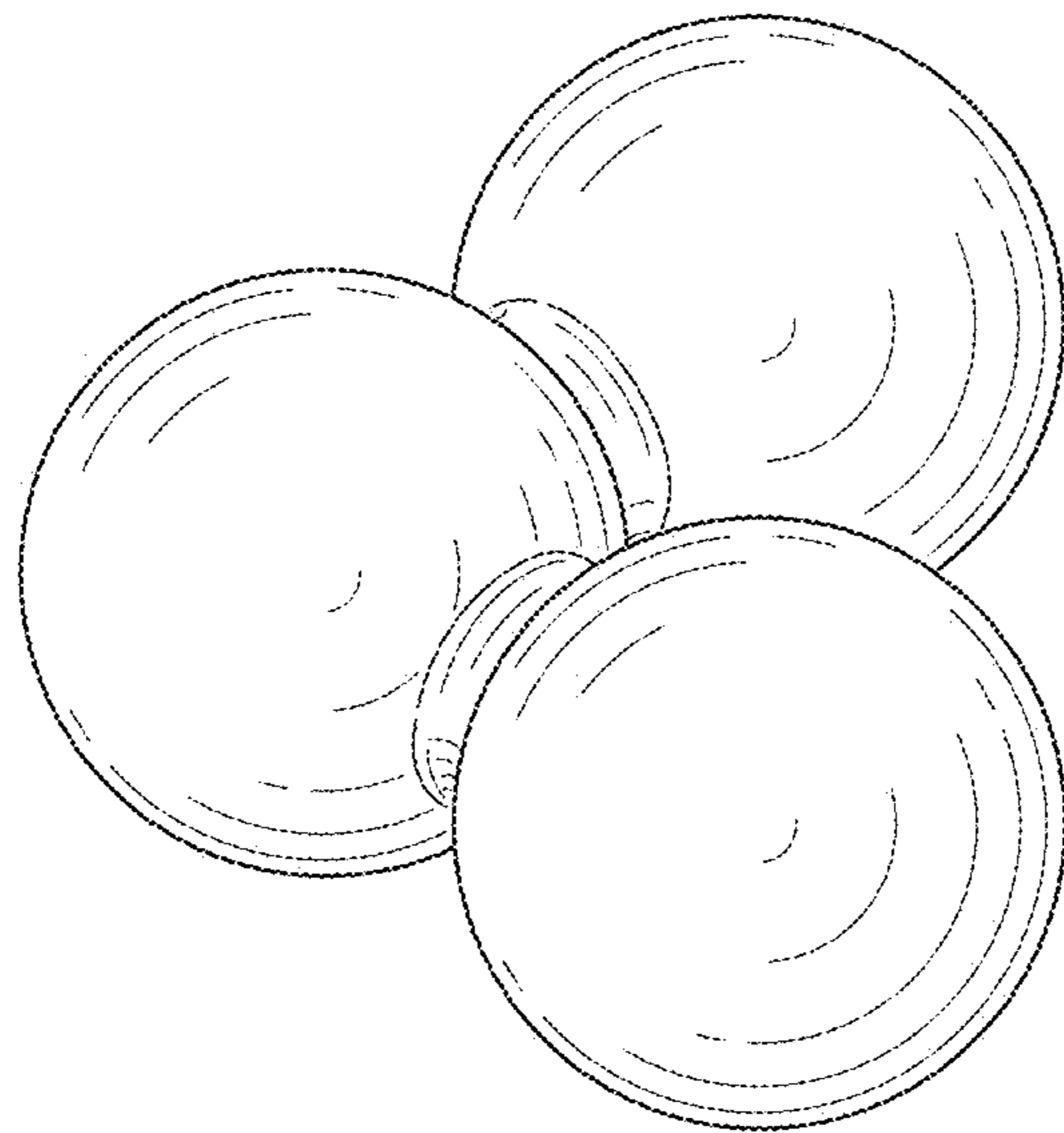

FIG. 43

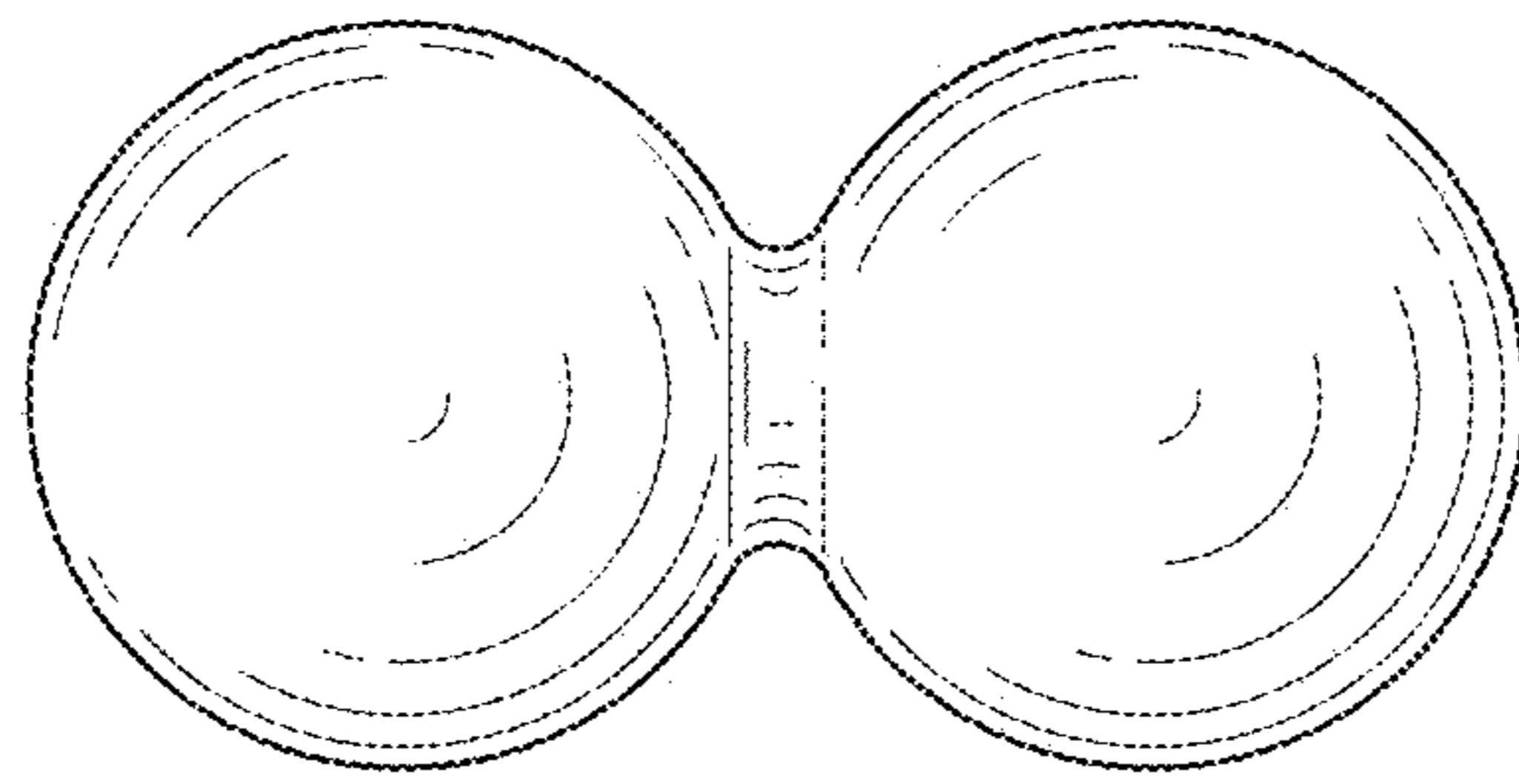

FIG. 44

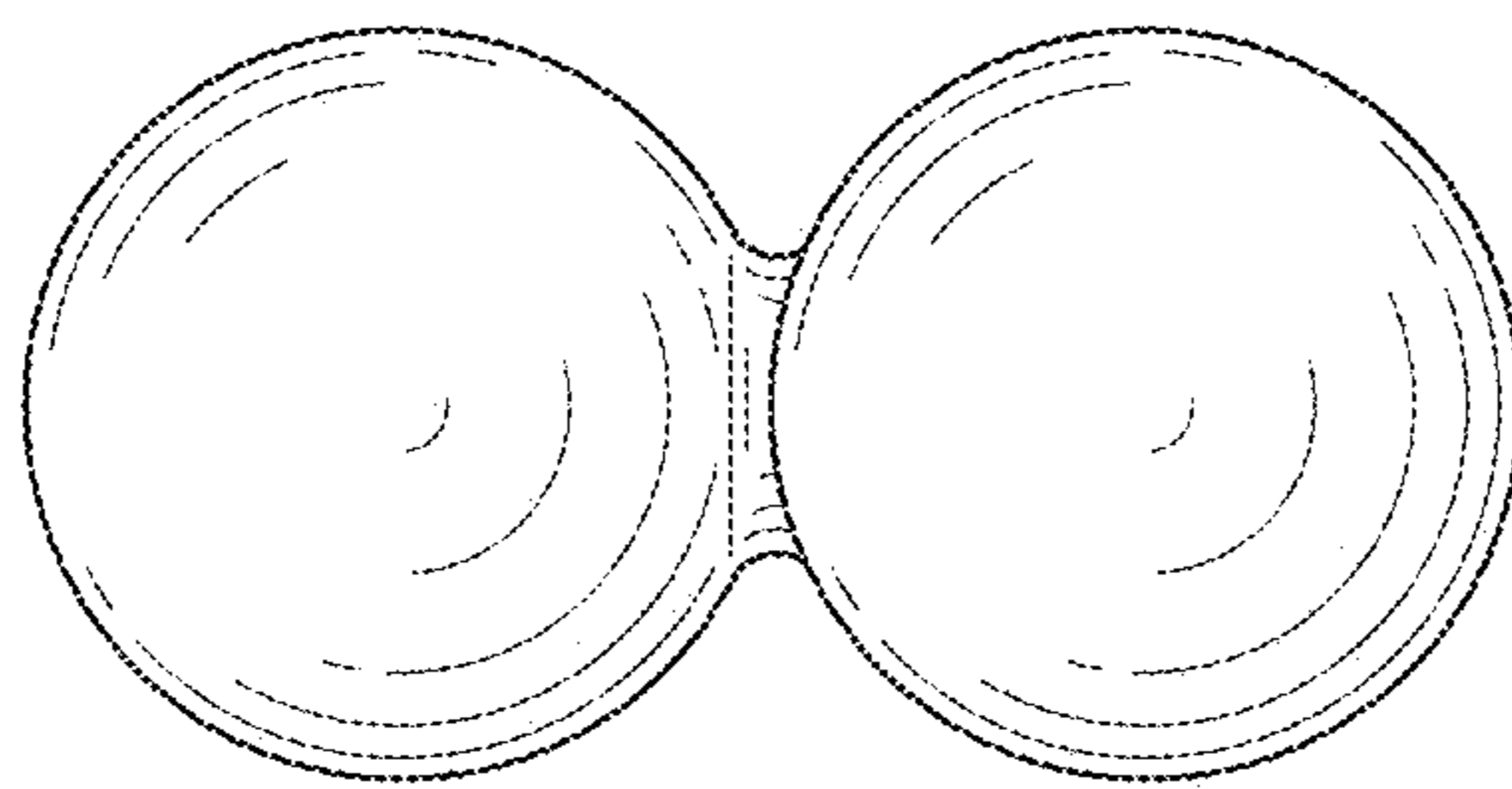

FIG. 45

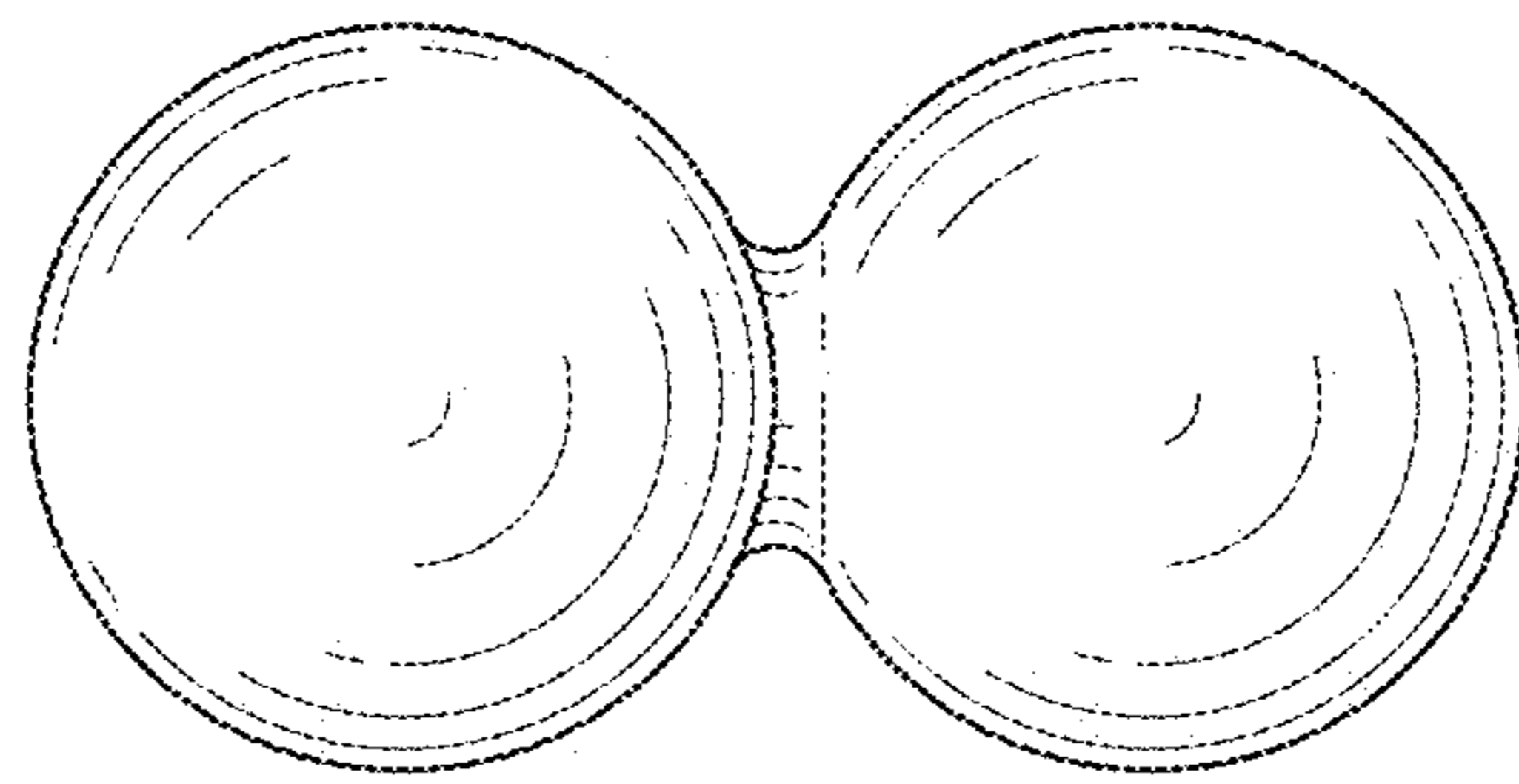

FIG. 46

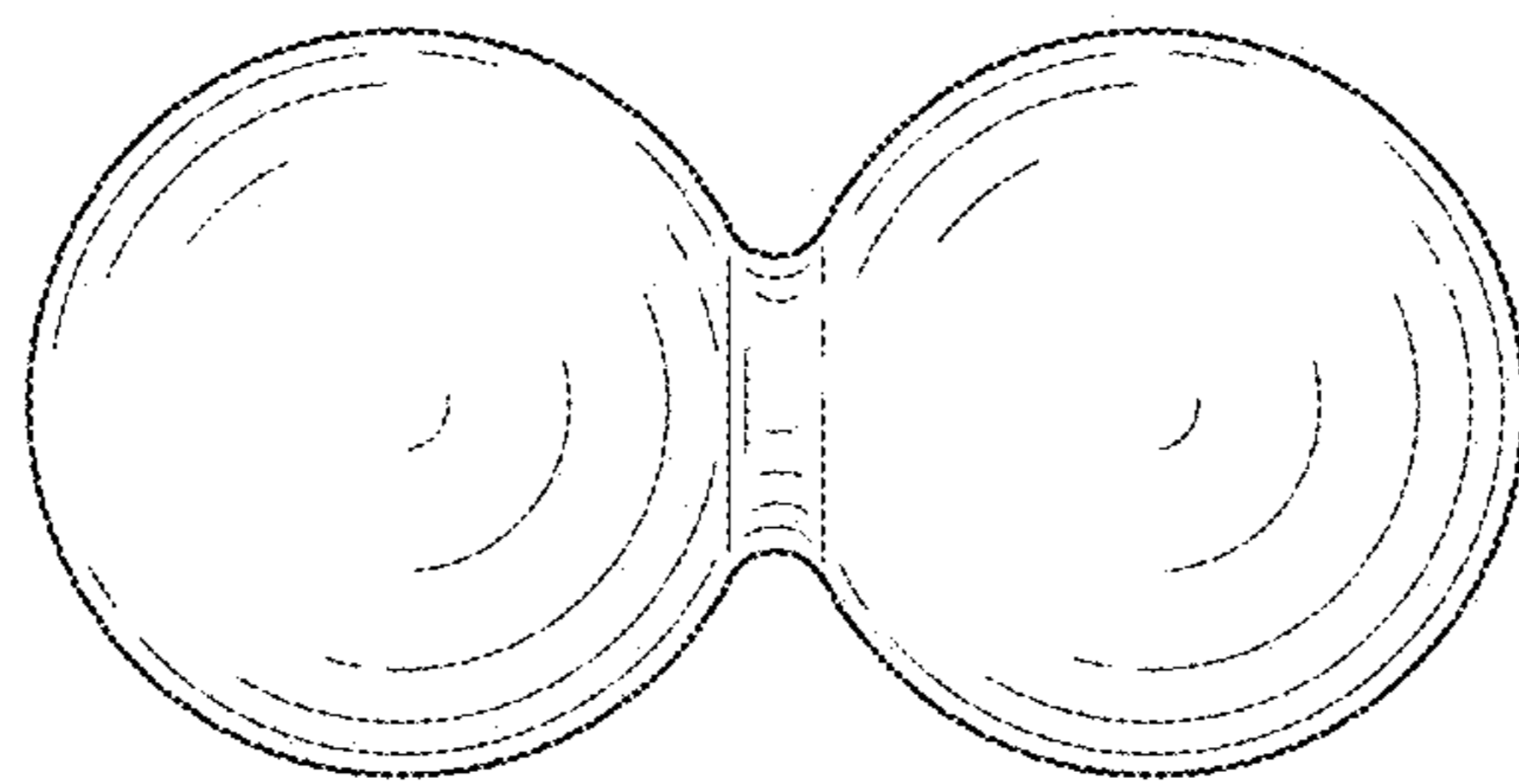

FIG. 47

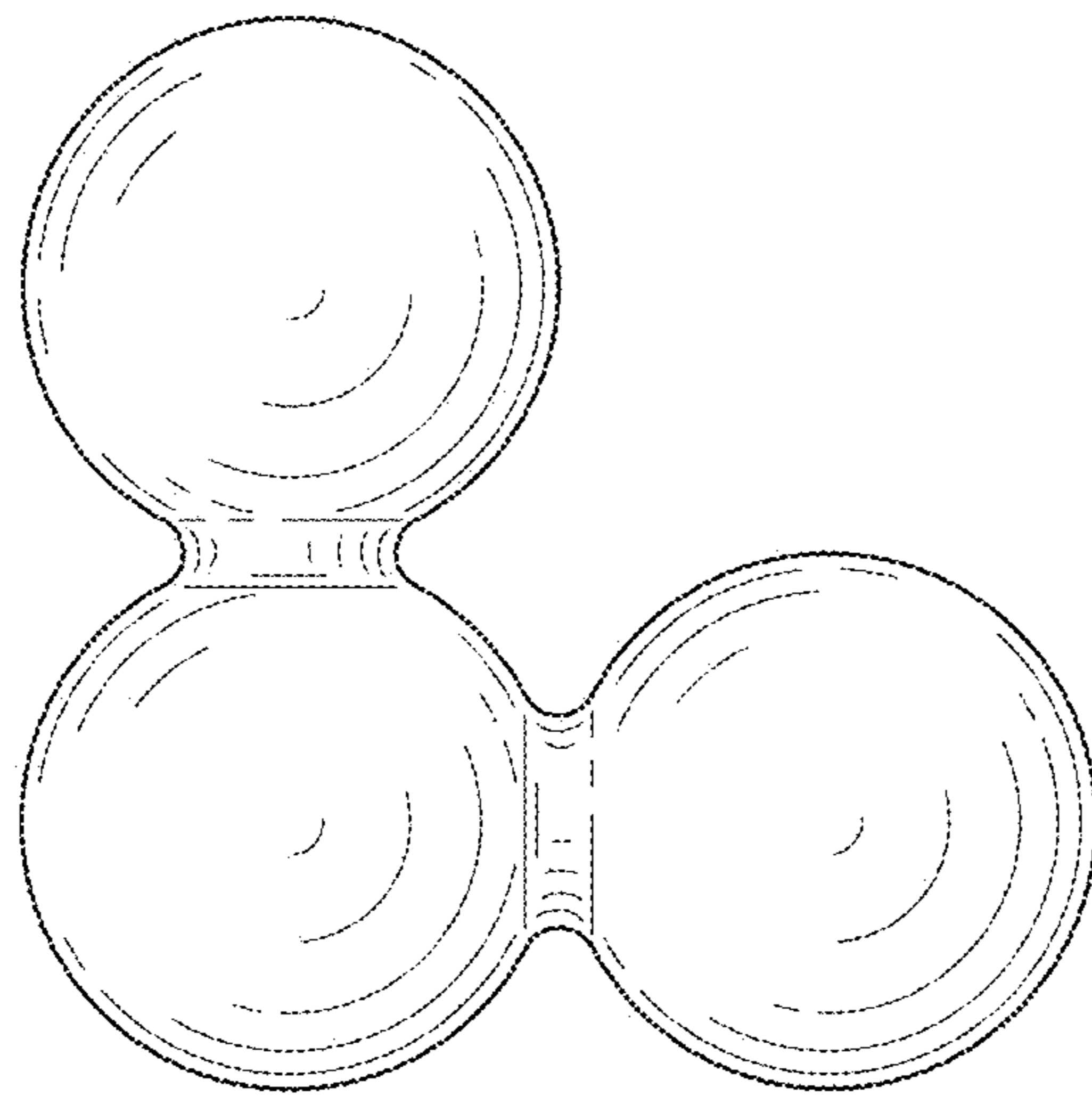

FIG. 48

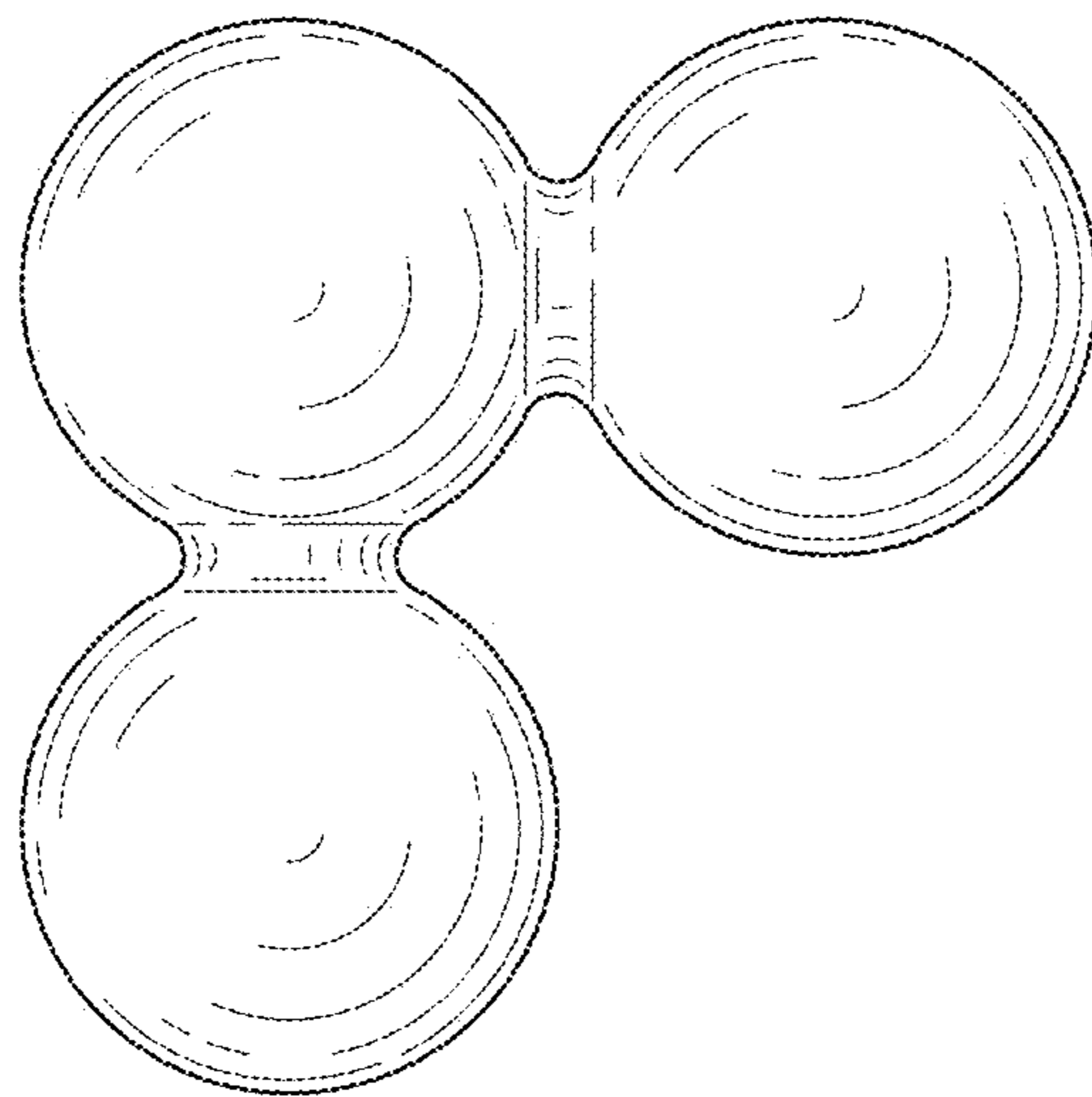

FIG. 49

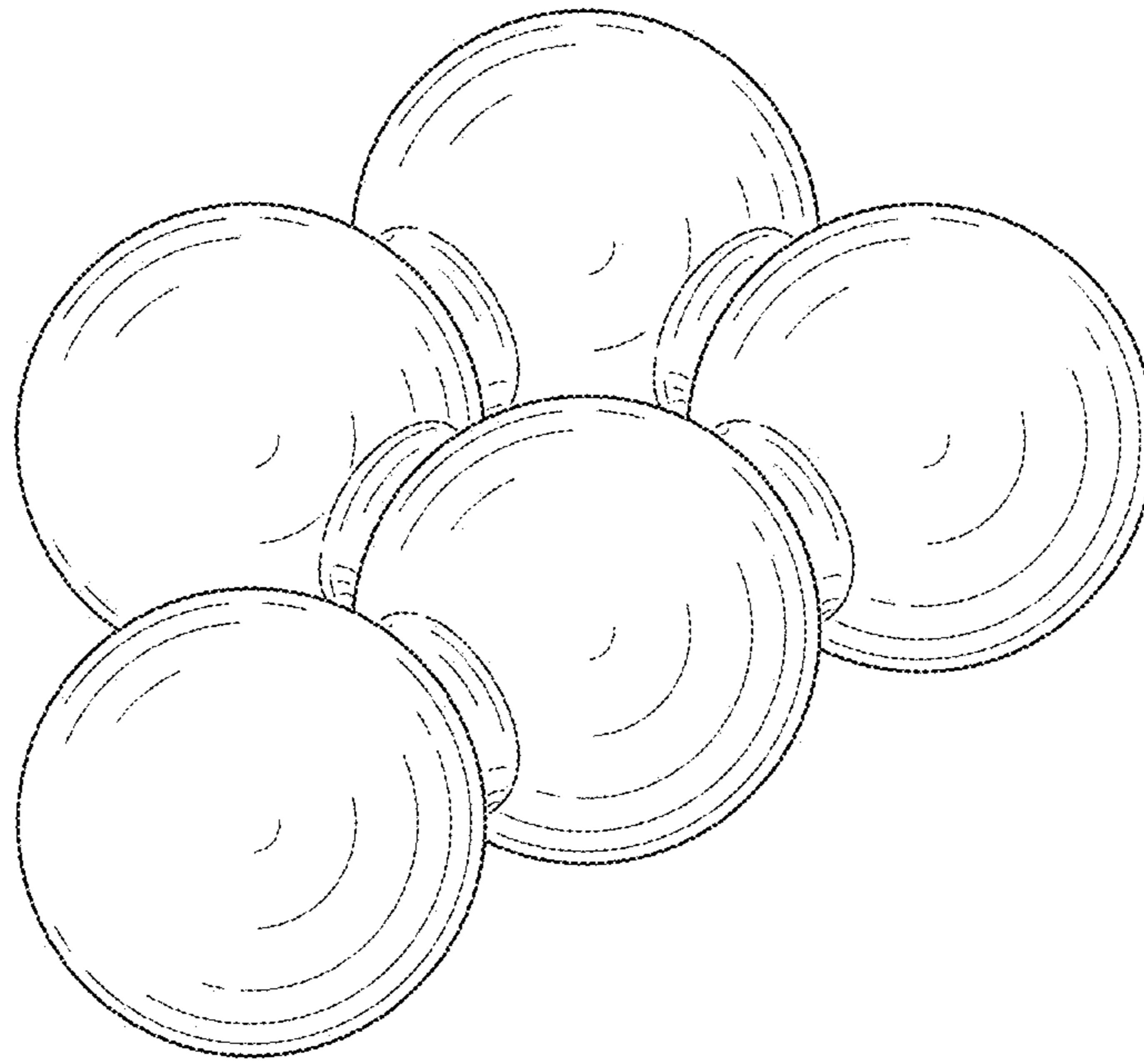

FIG. 50

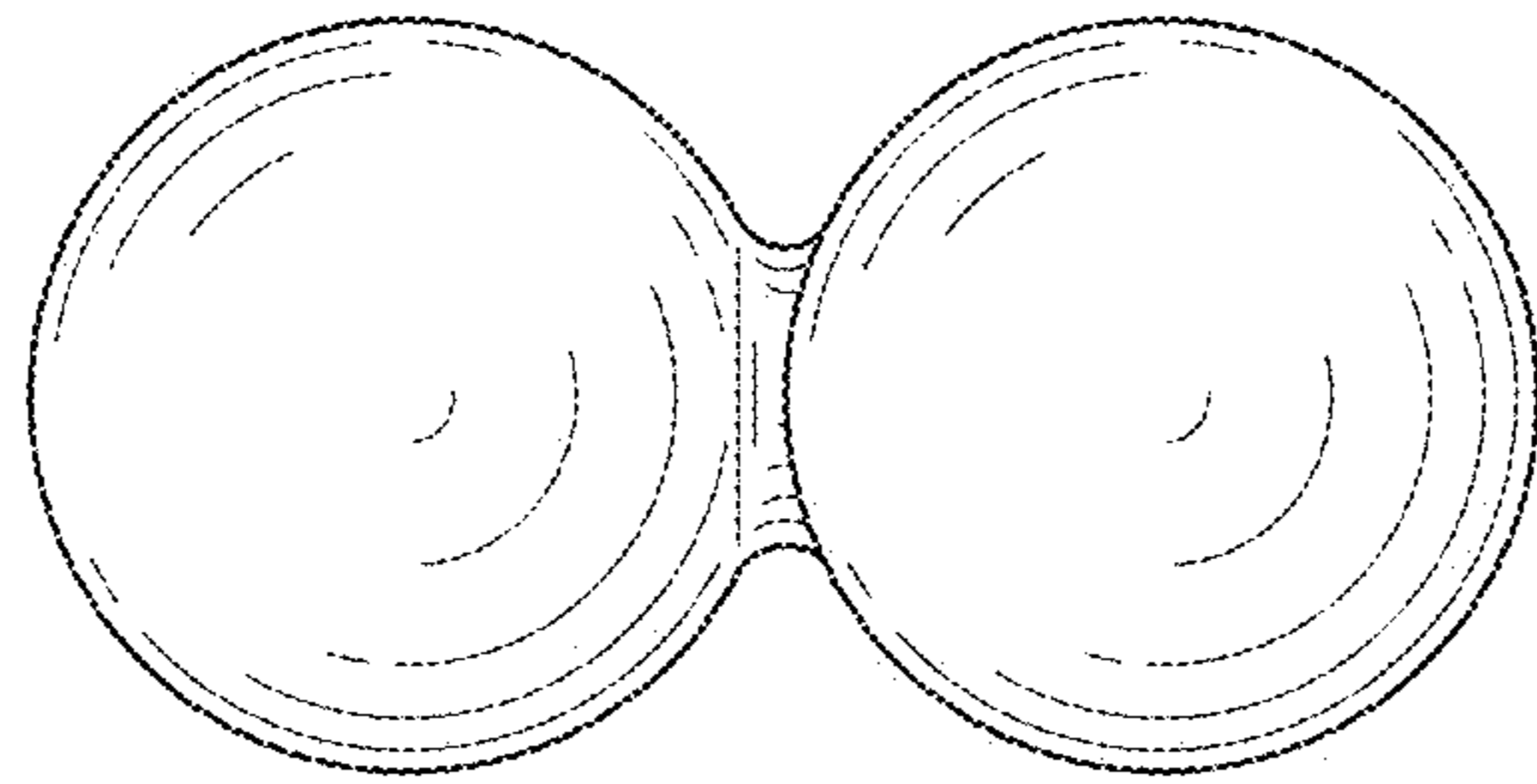

FIG. 51

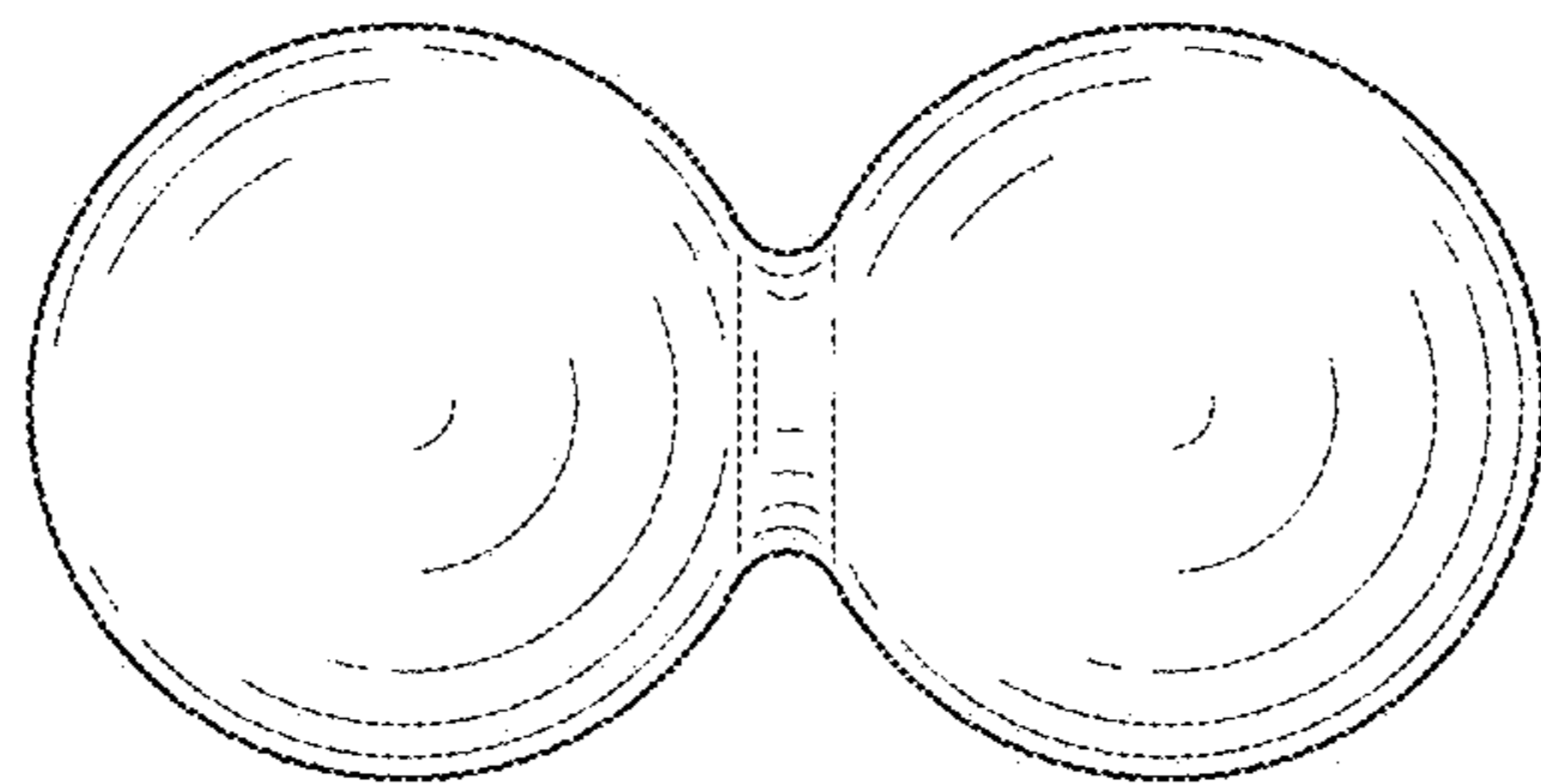

FIG. 52

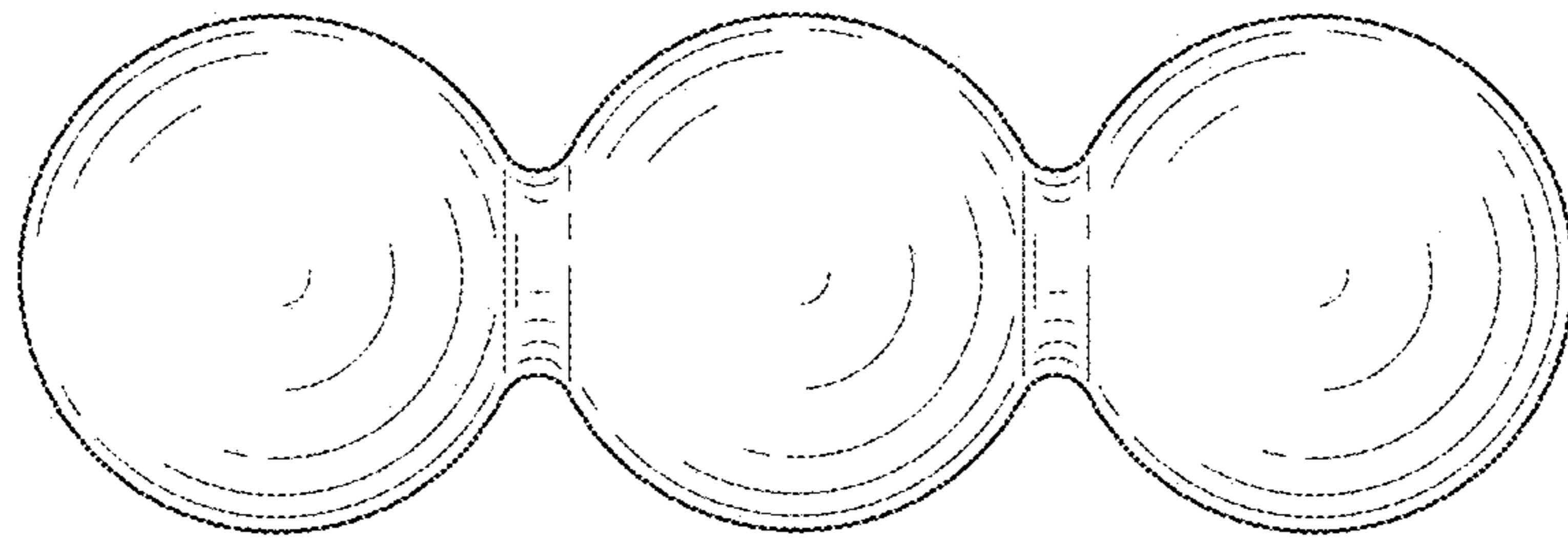

FIG. 53

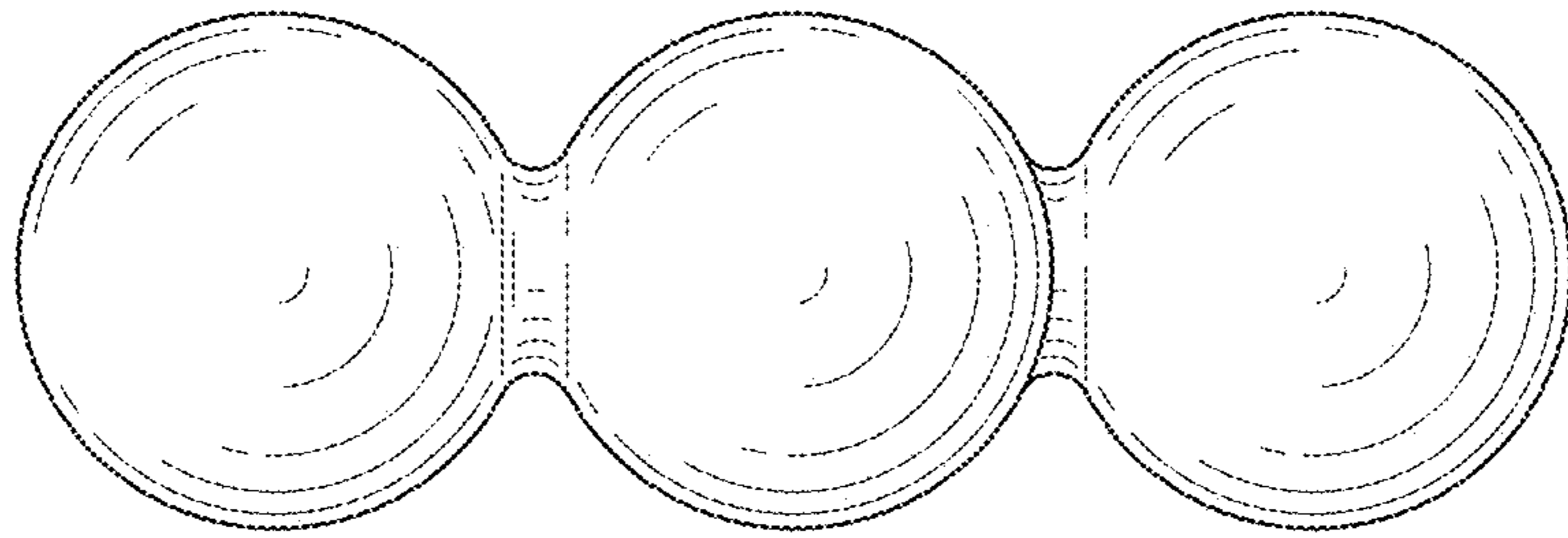

FIG. 54

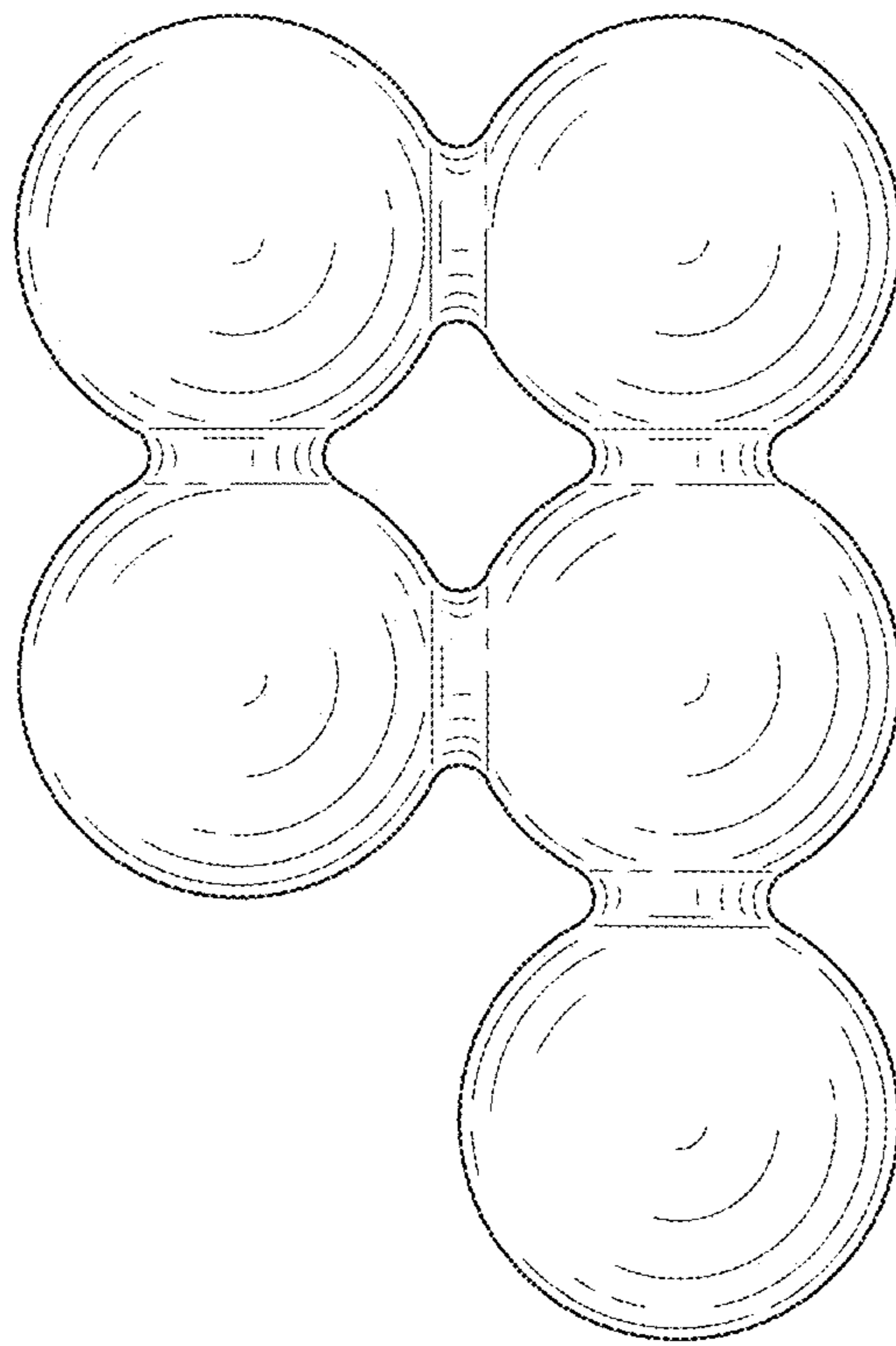

FIG. 55

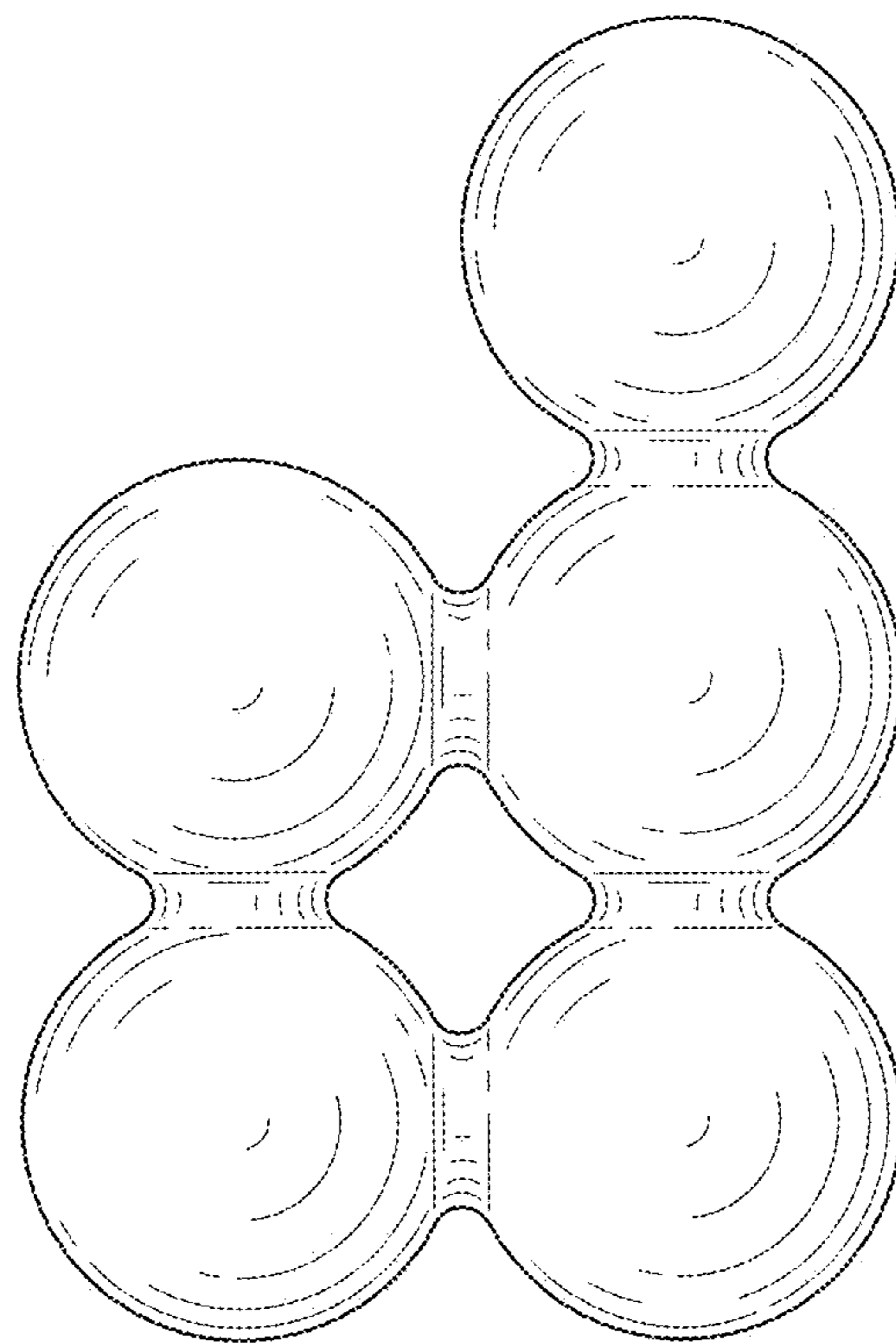

FIG. 56

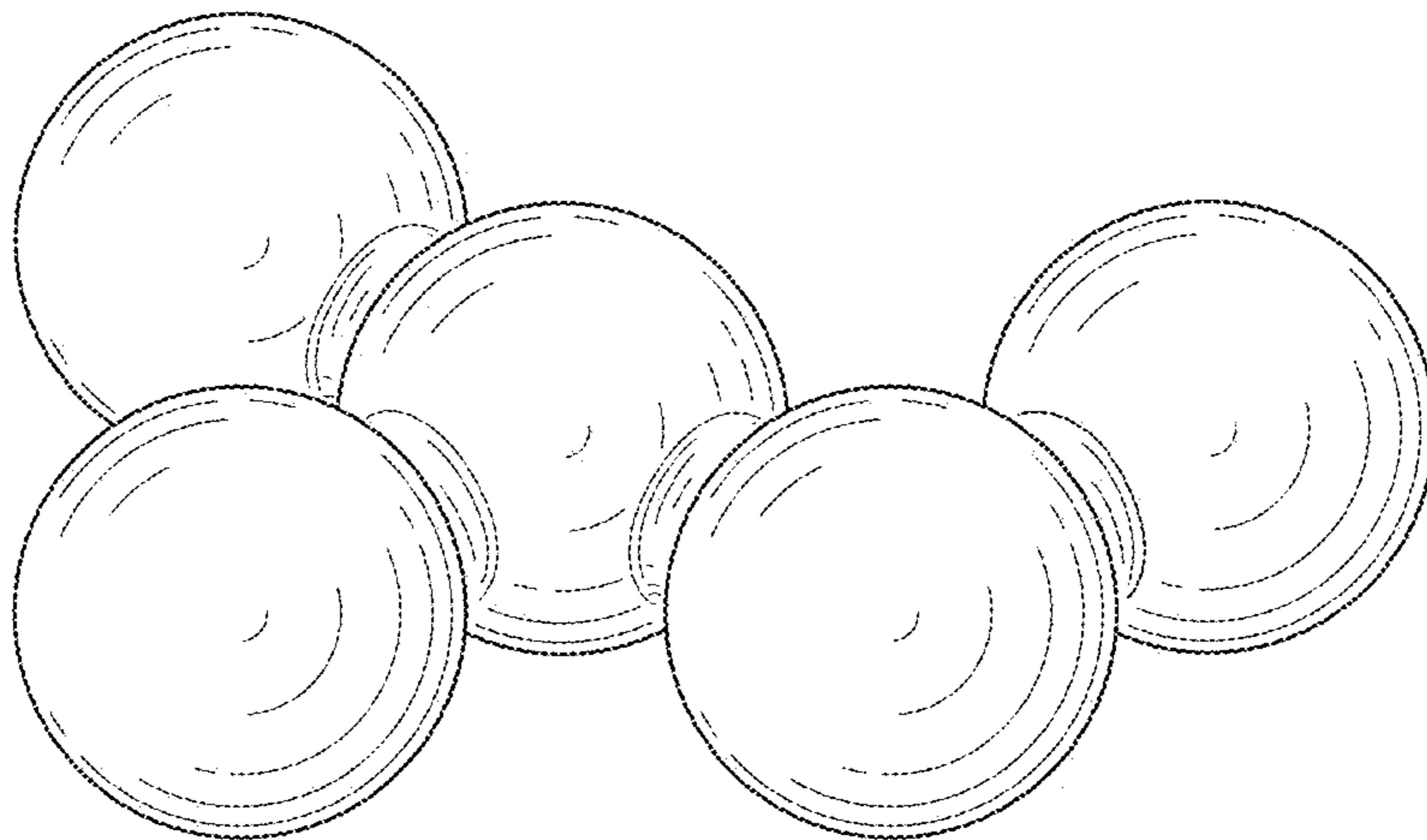

FIG. 57

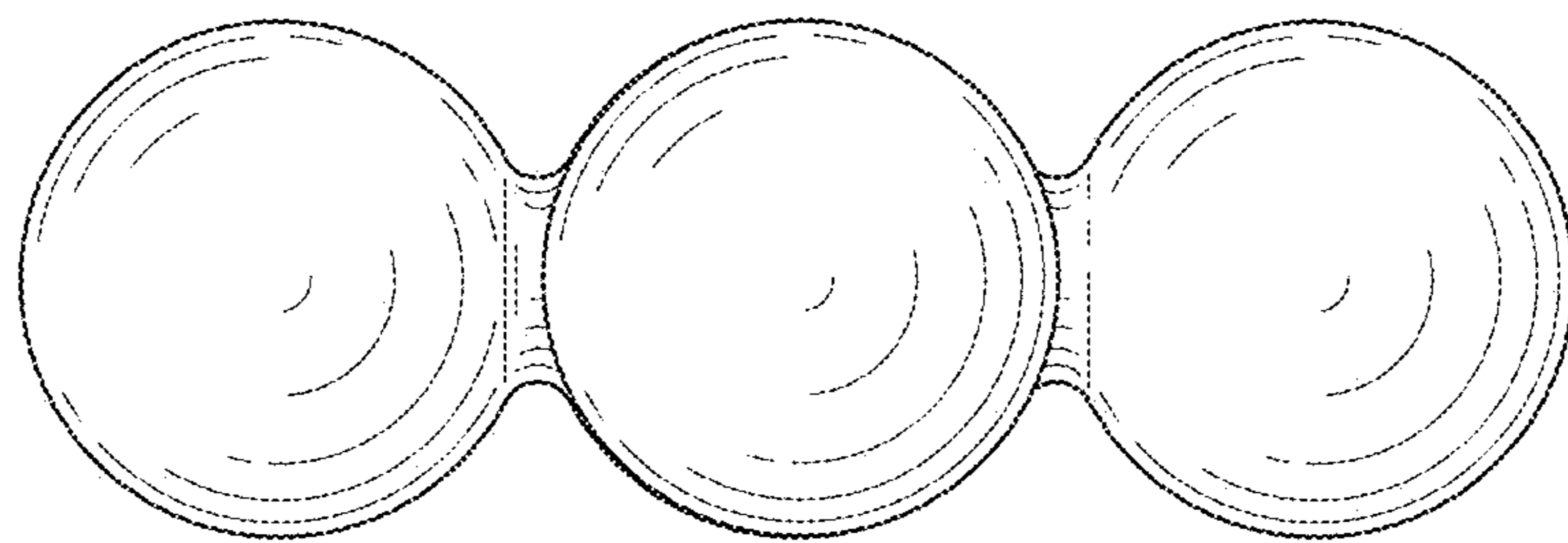

FIG. 58

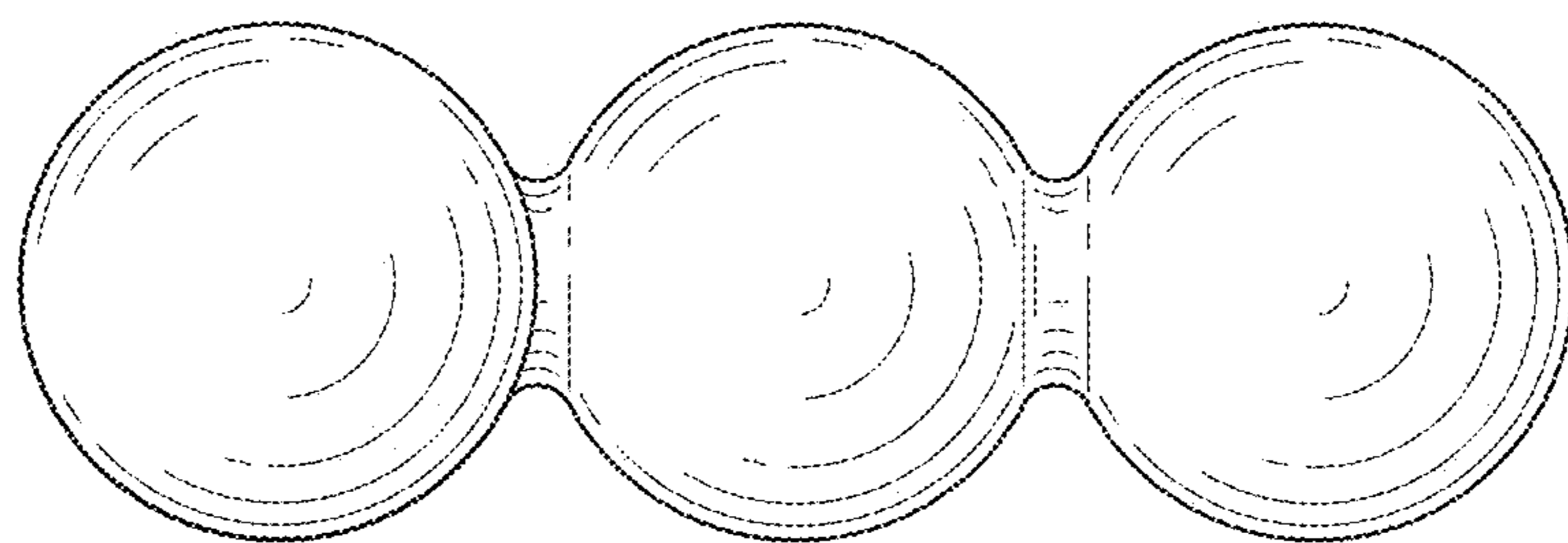

FIG. 59

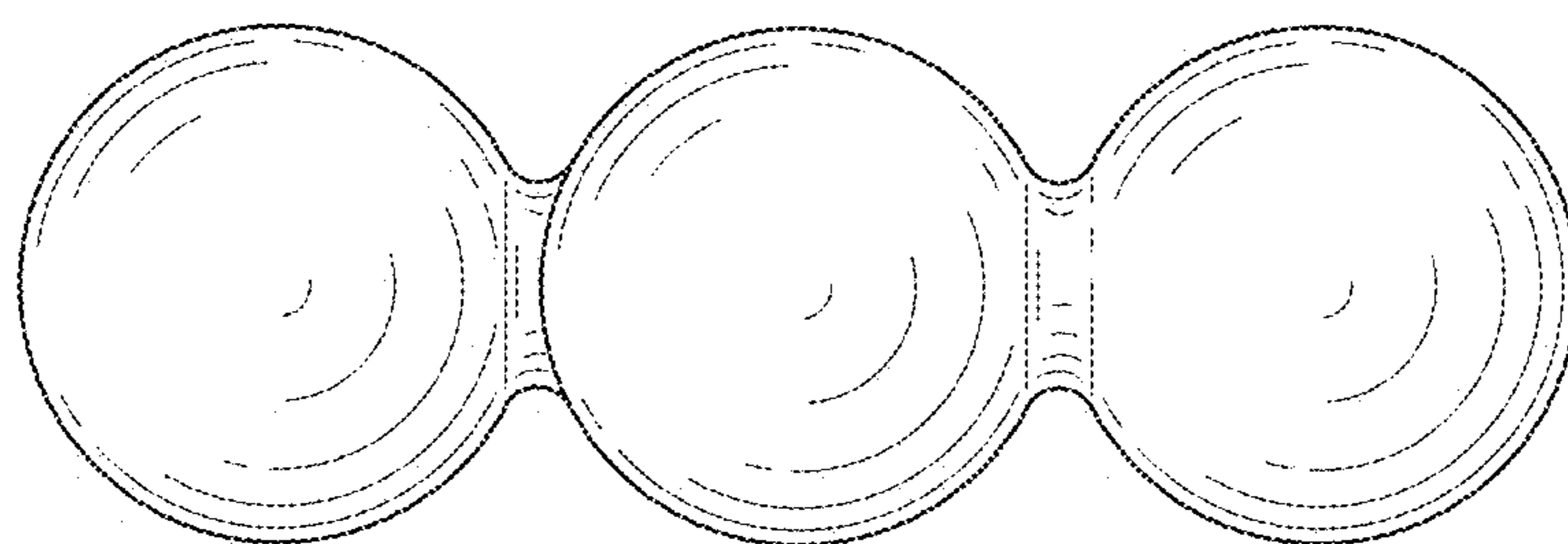

FIG. 60

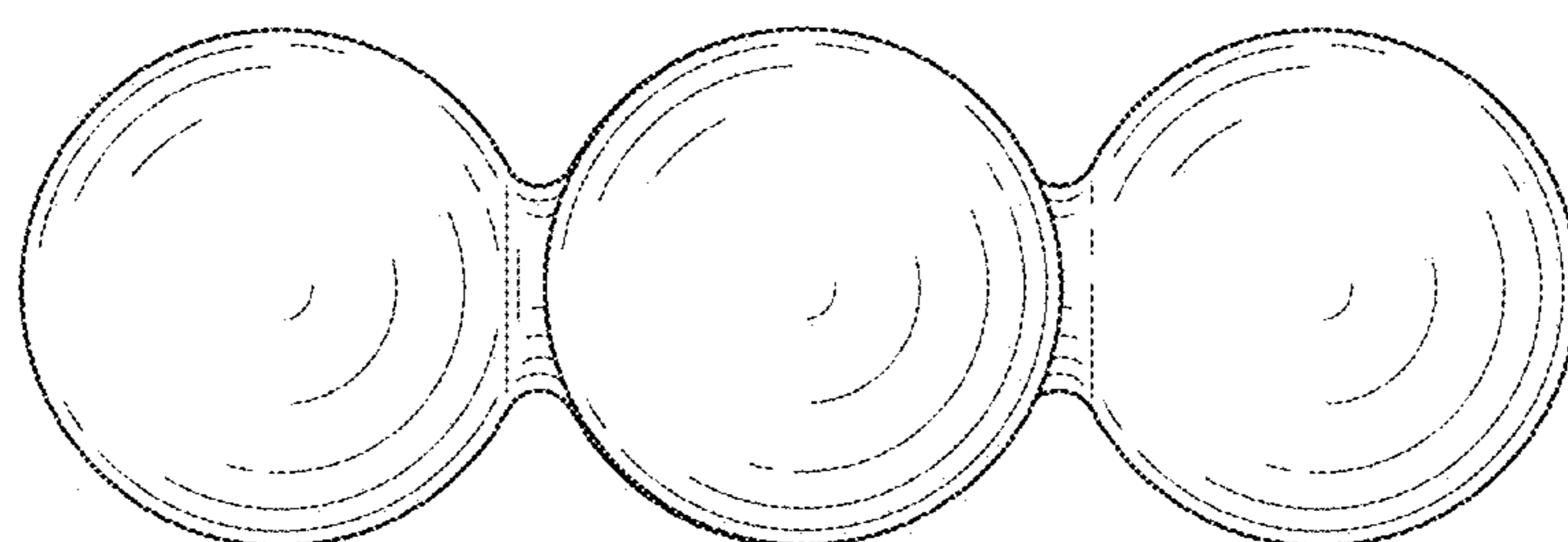

FIG. 61

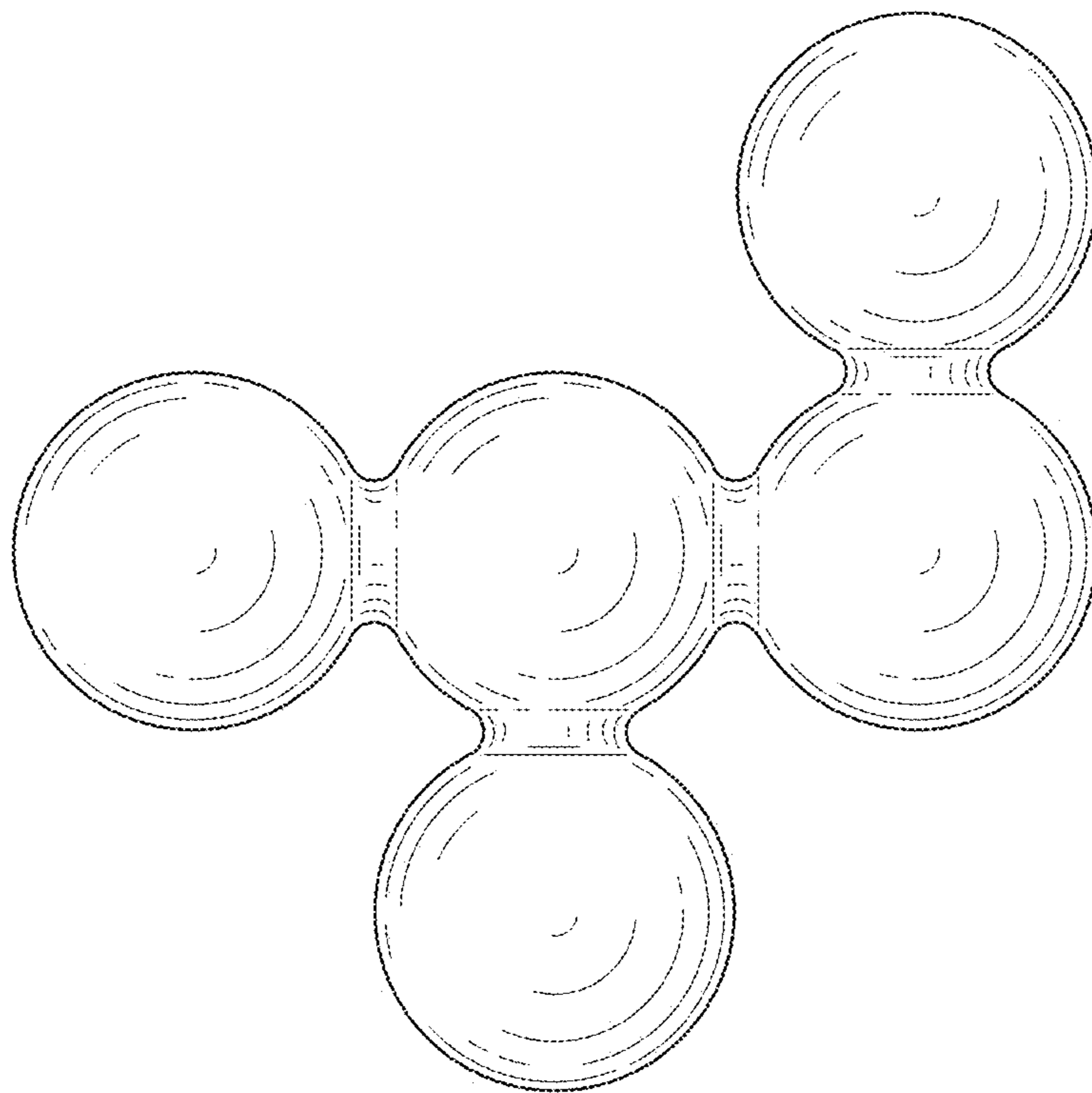

FIG. 62

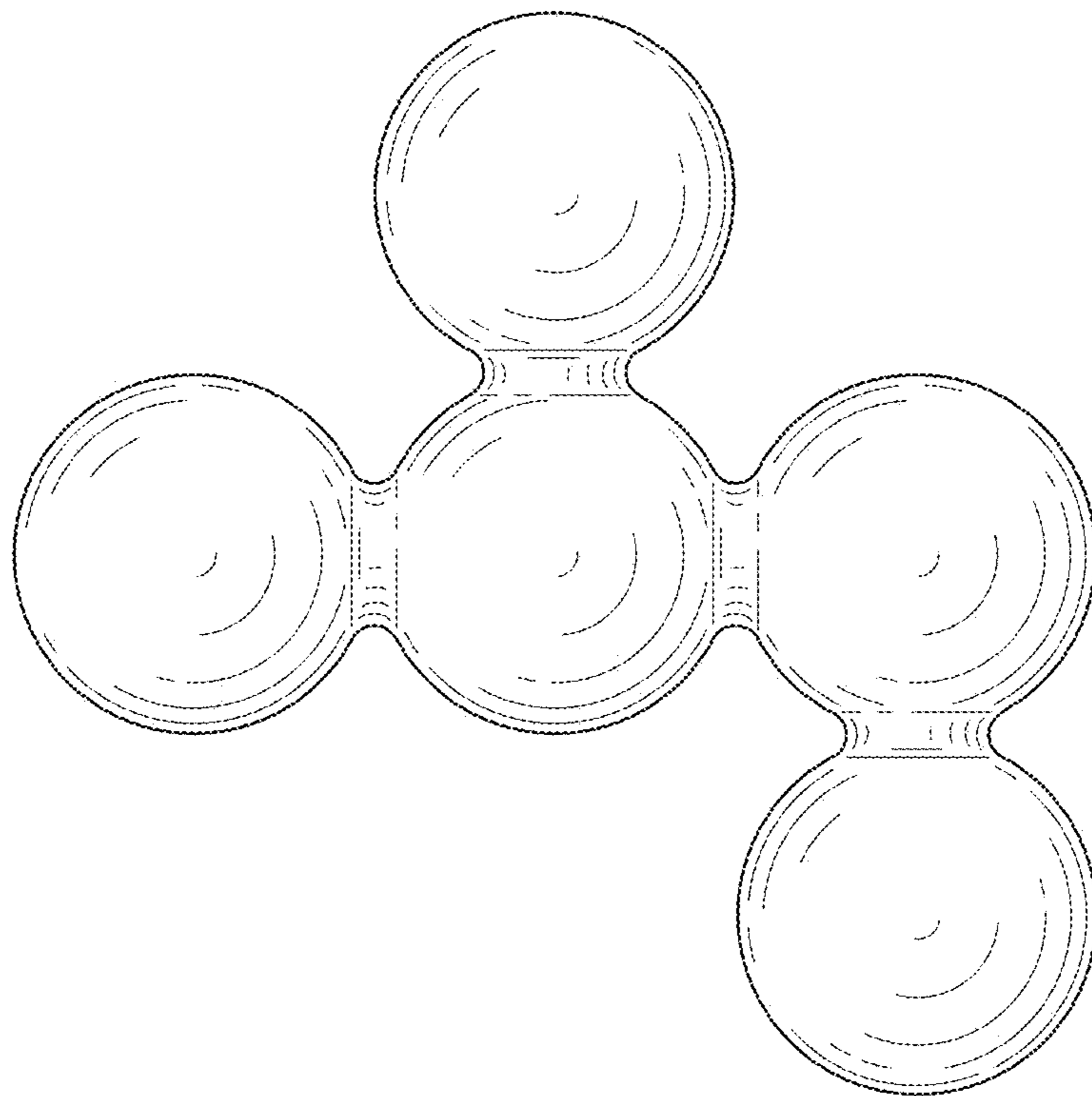

FIG. 63

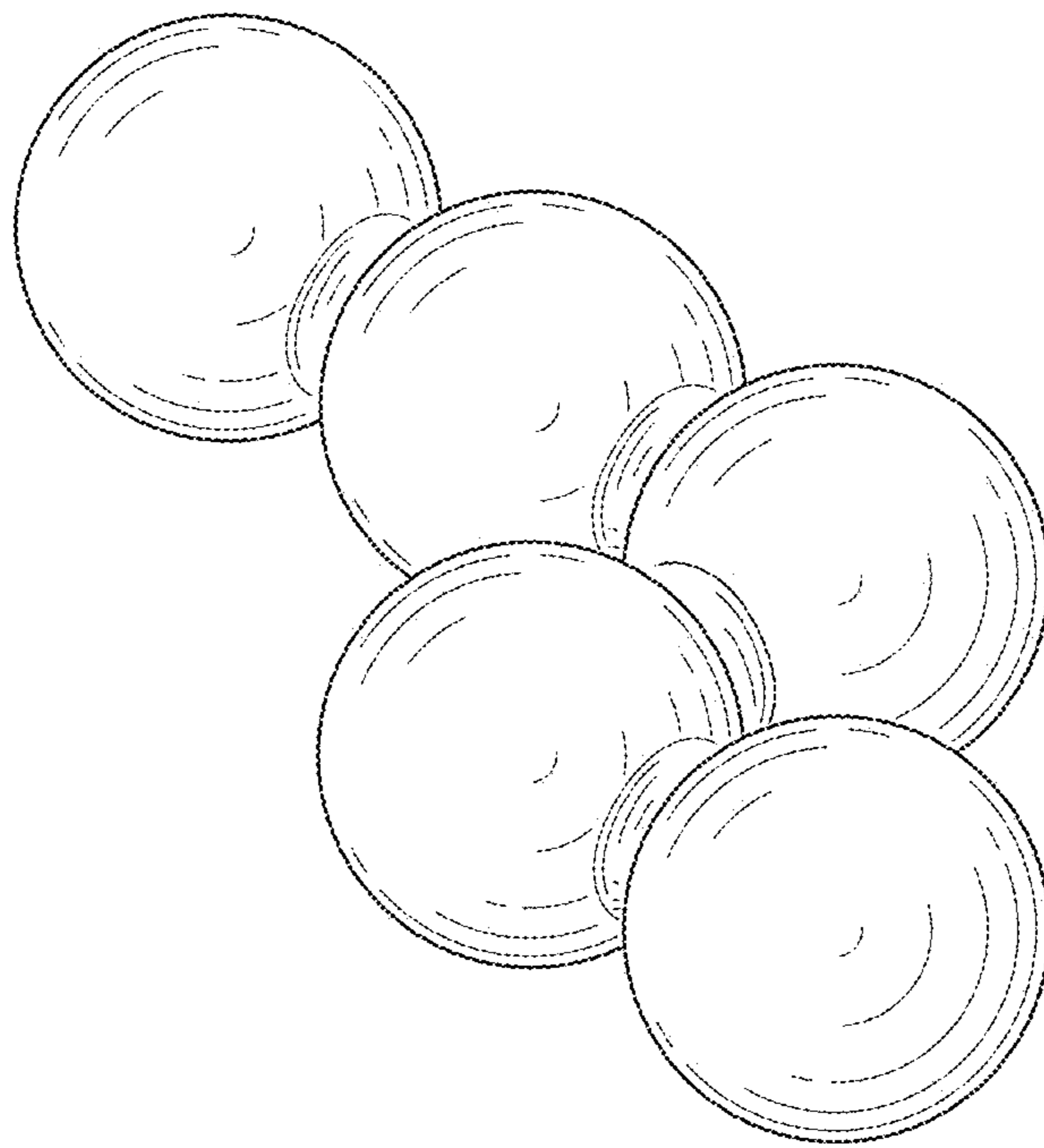

FIG. 64

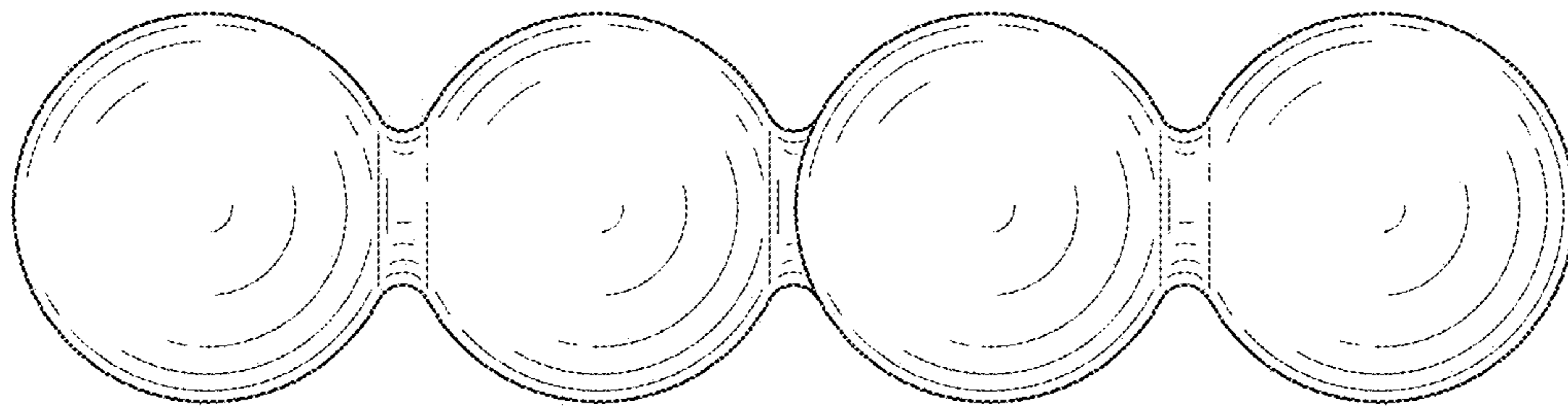

FIG. 65

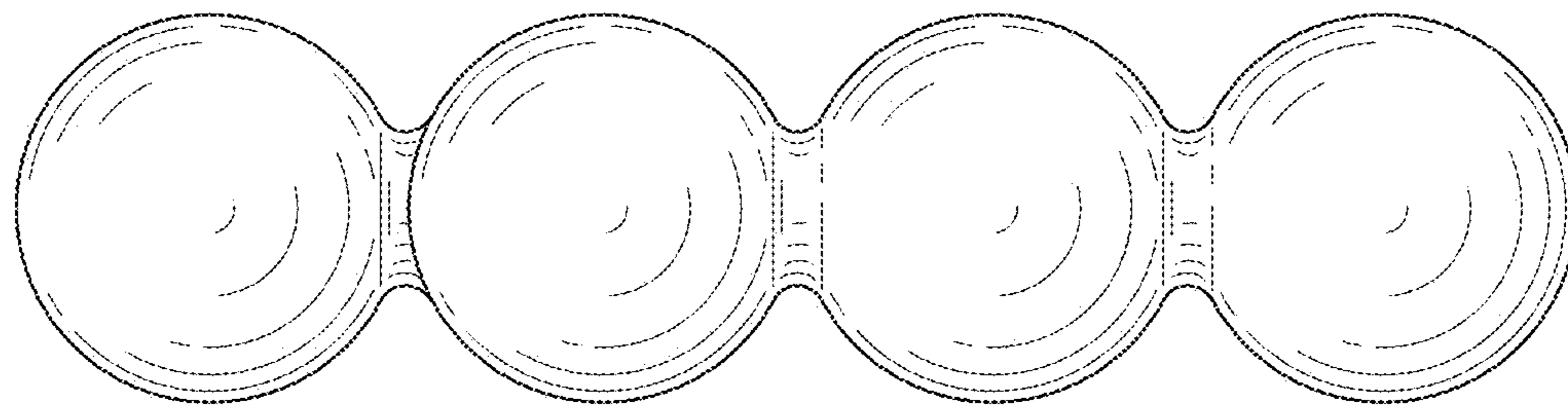

FIG. 66

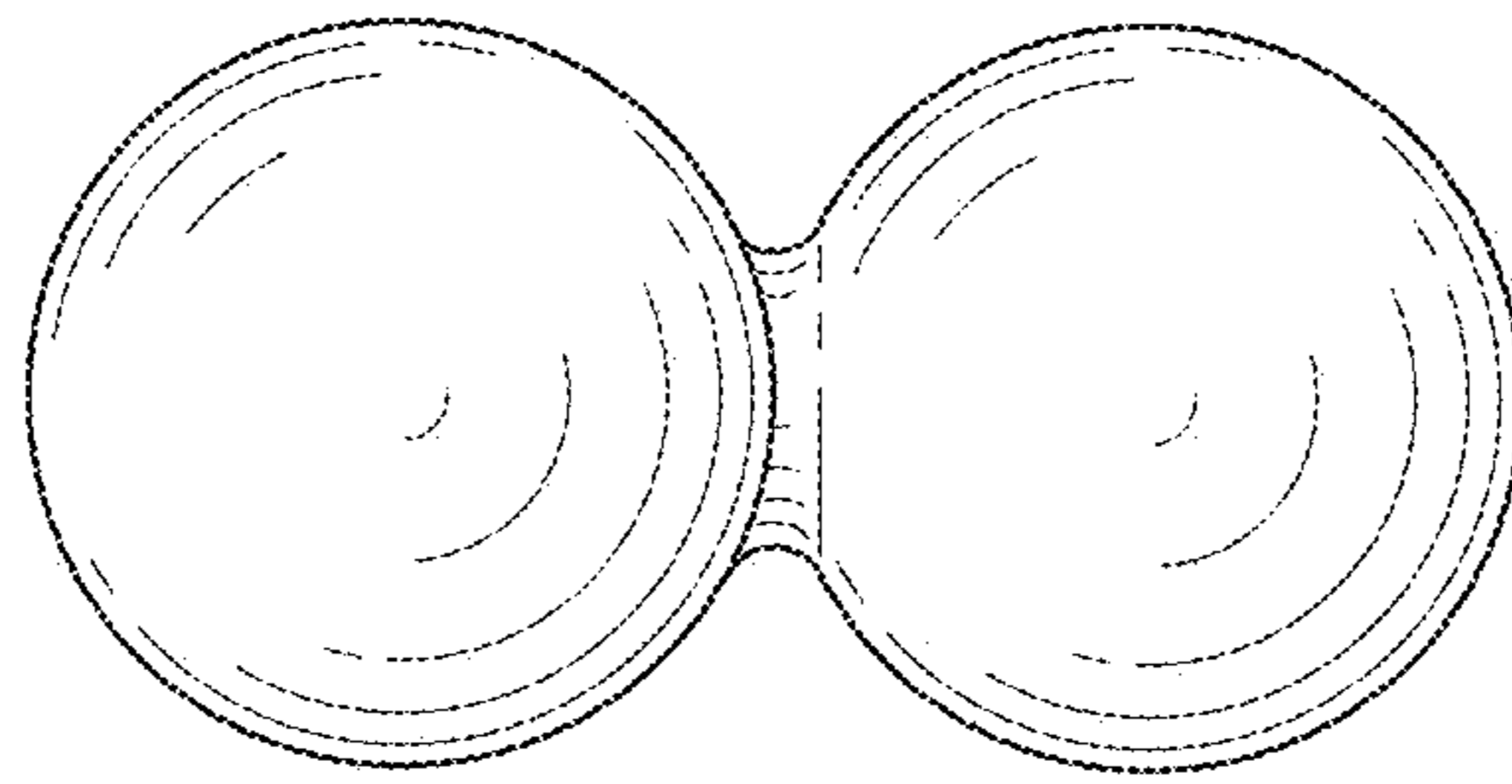

FIG. 67

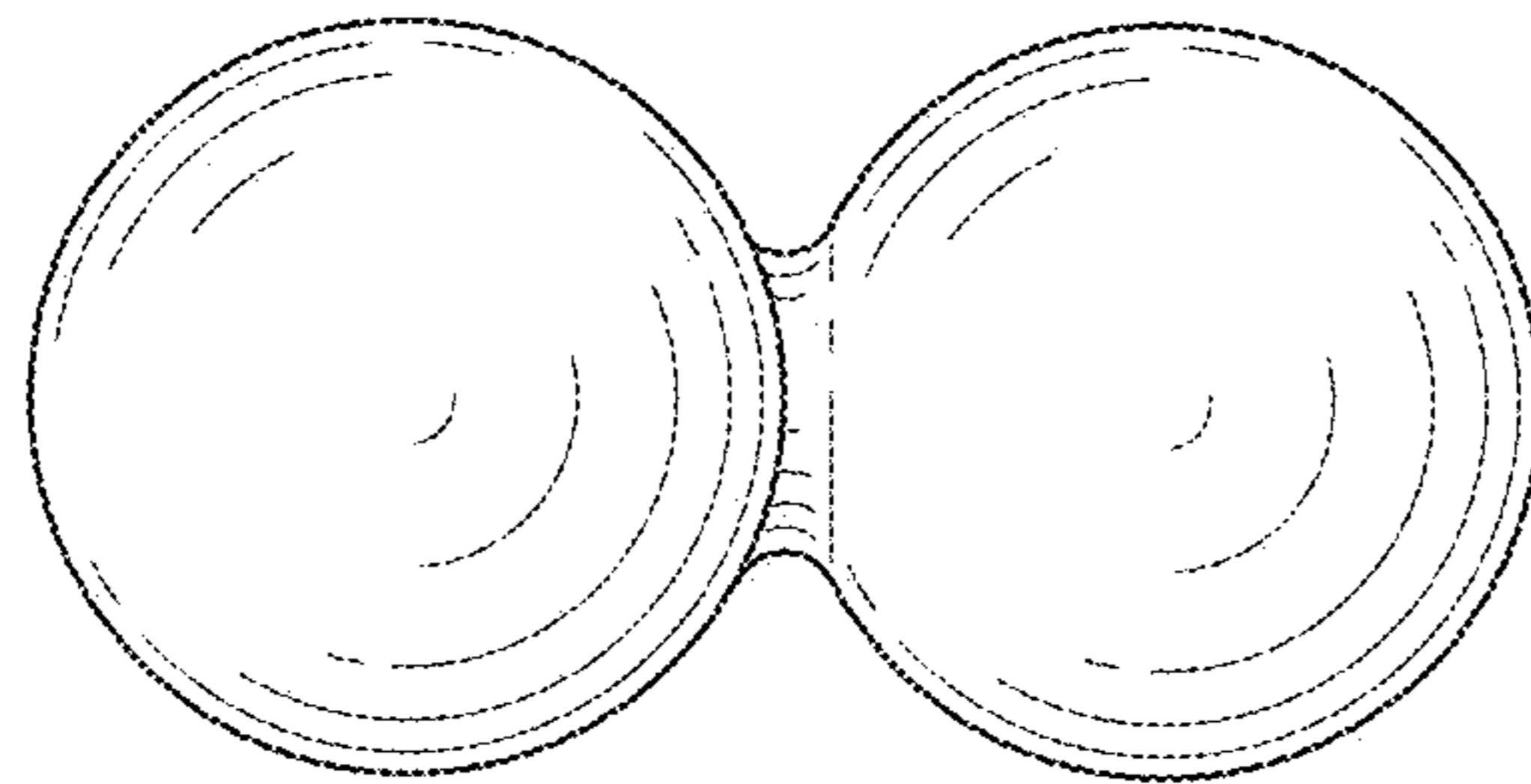

FIG. 68

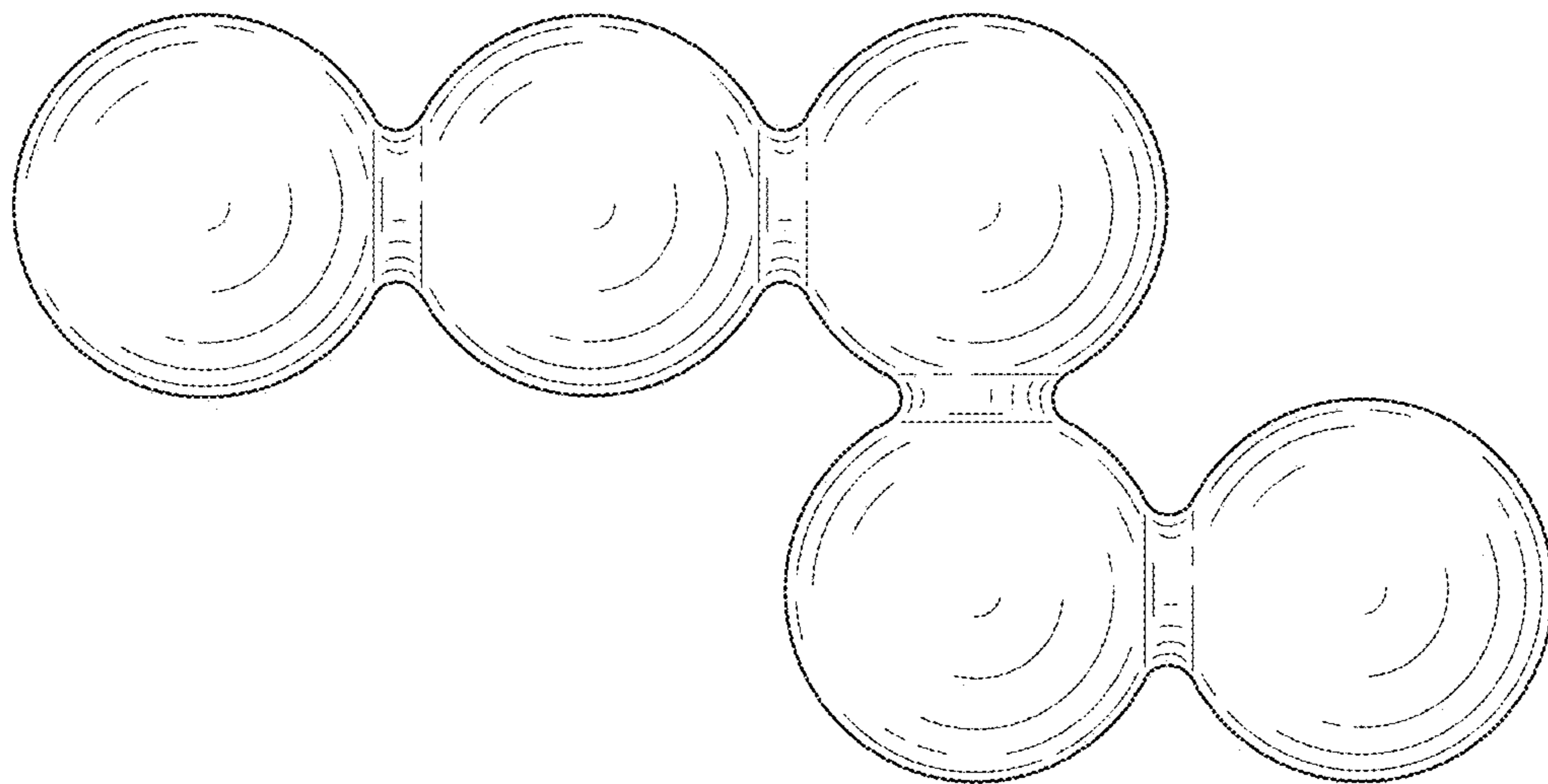

FIG. 69

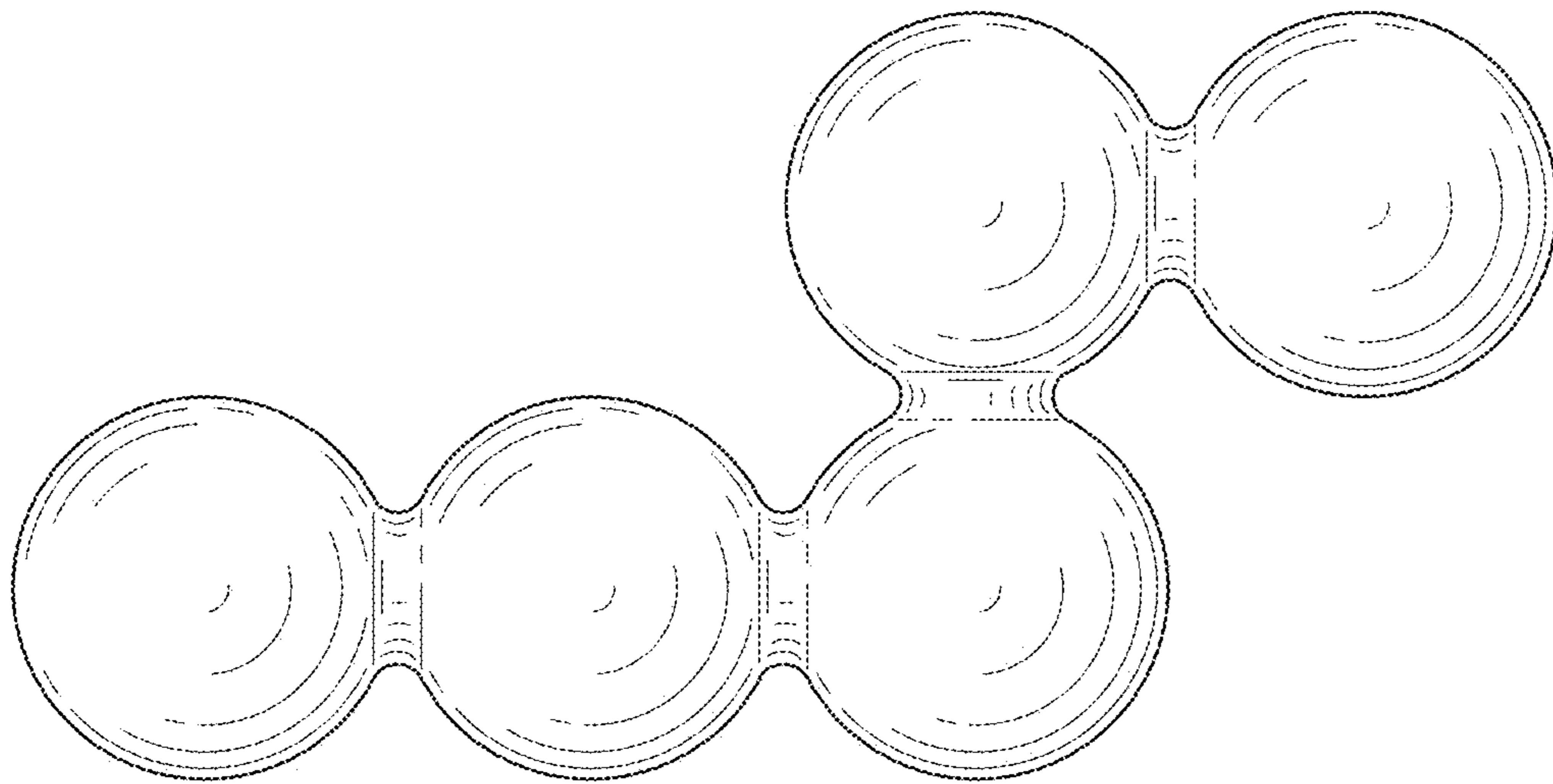

FIG. 70

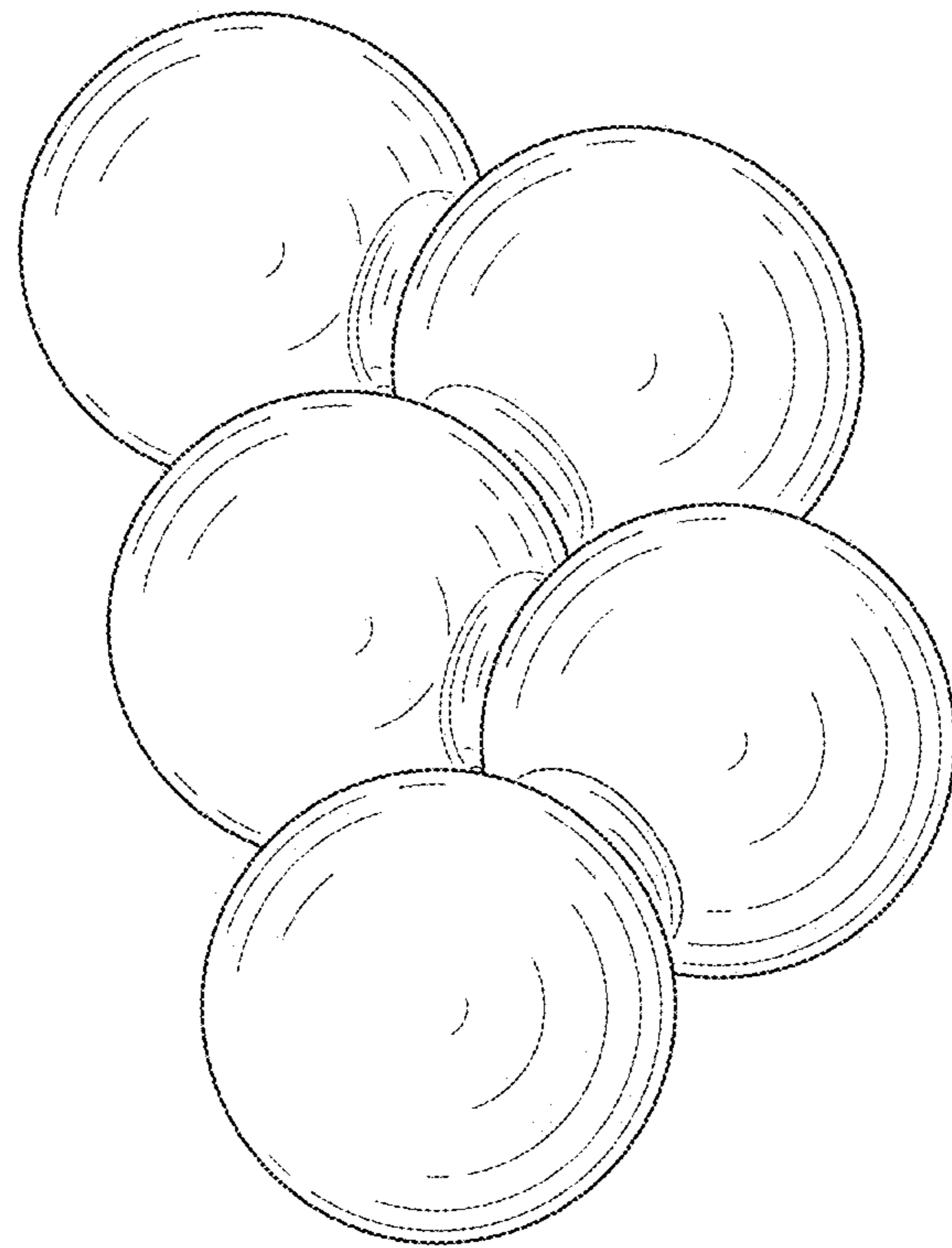

FIG. 71

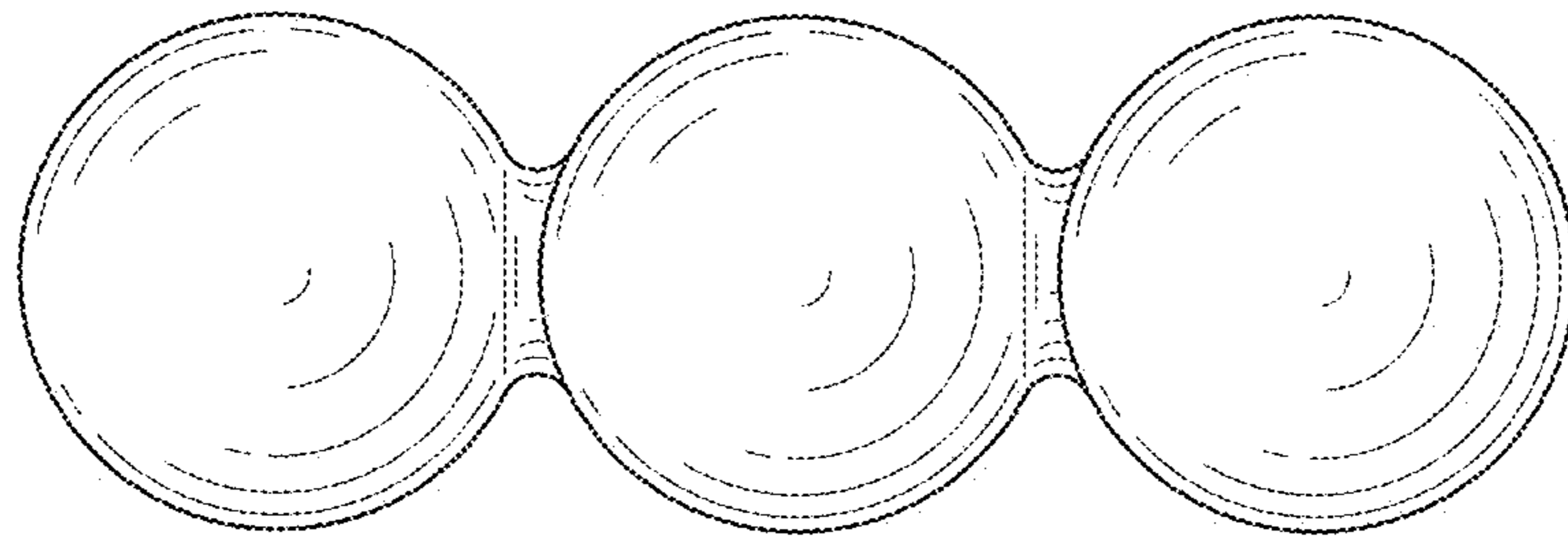

FIG. 72

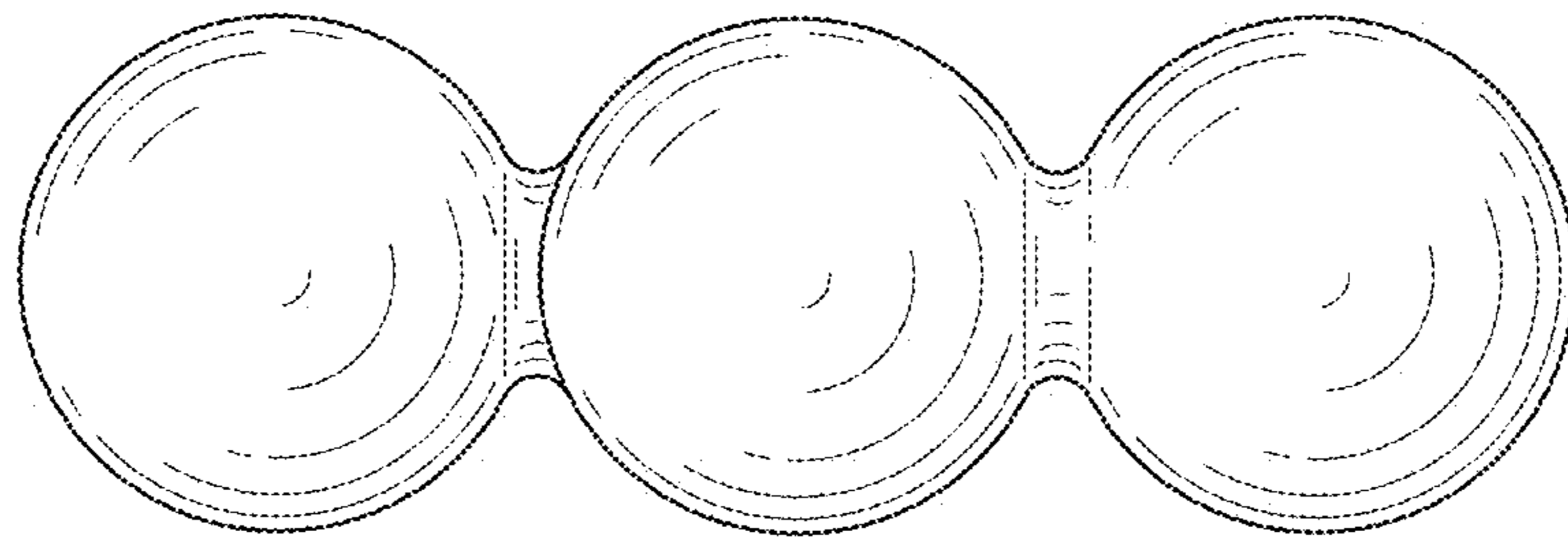

FIG. 73

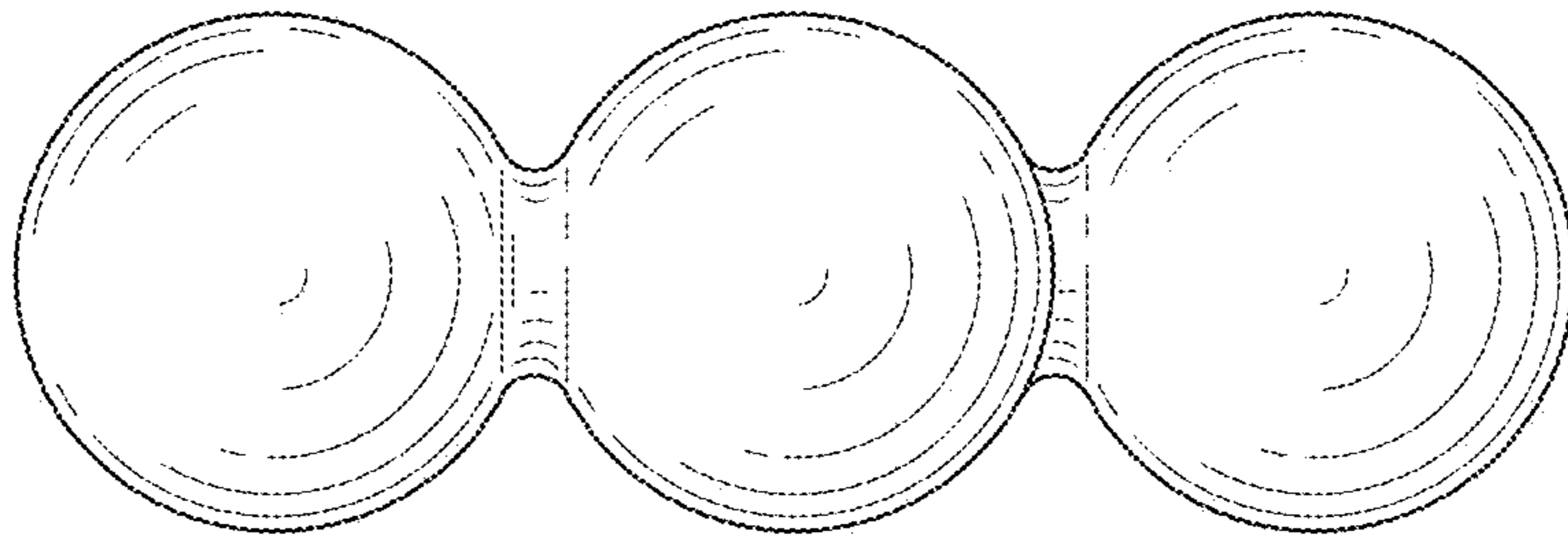

FIG. 74

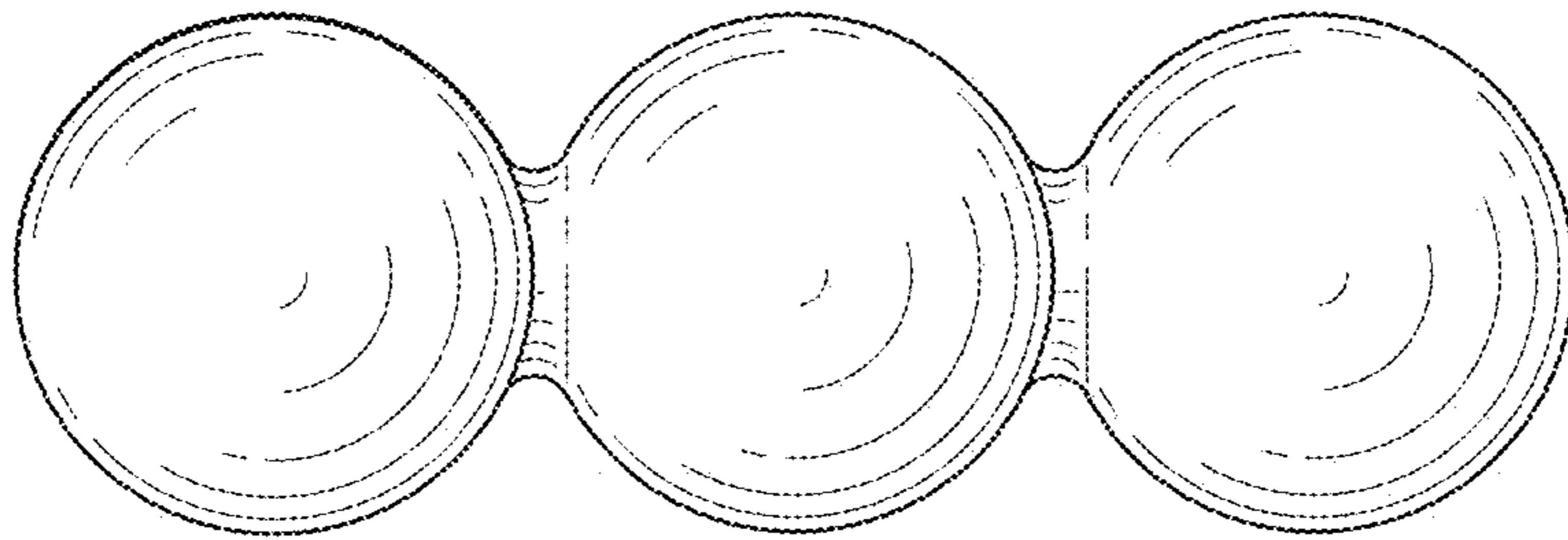

FIG. 75

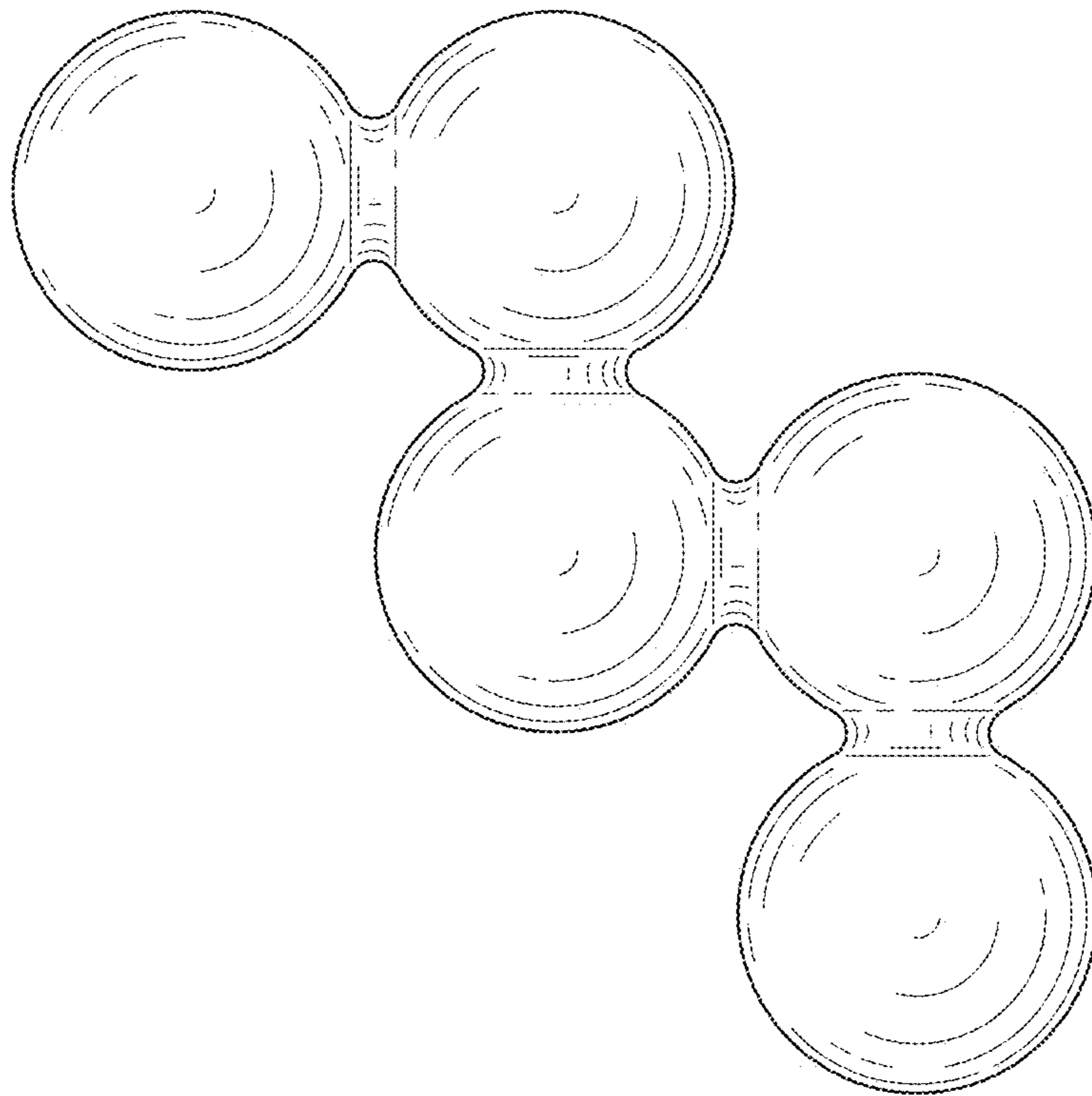

FIG. 76

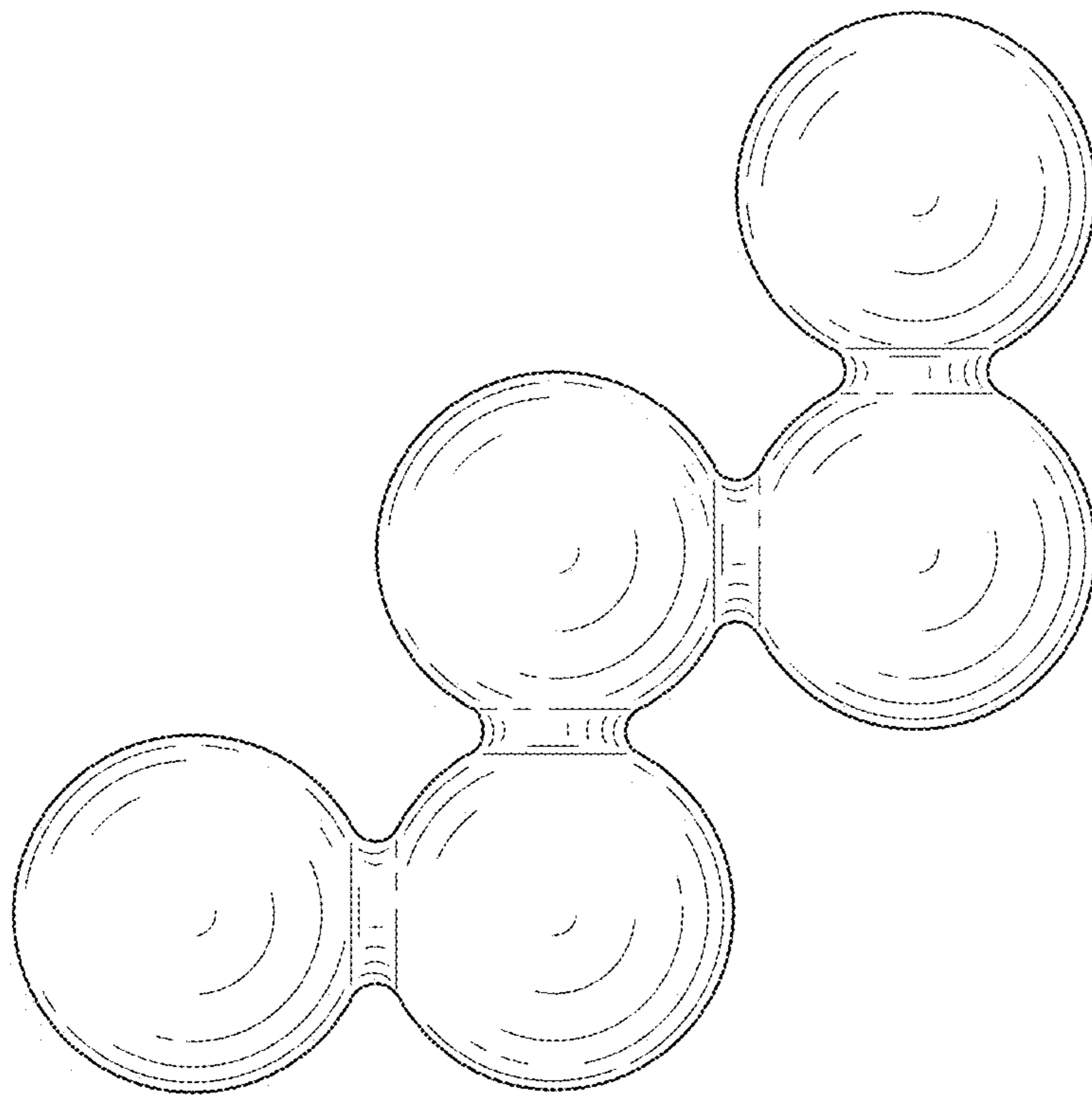

FIG. 77

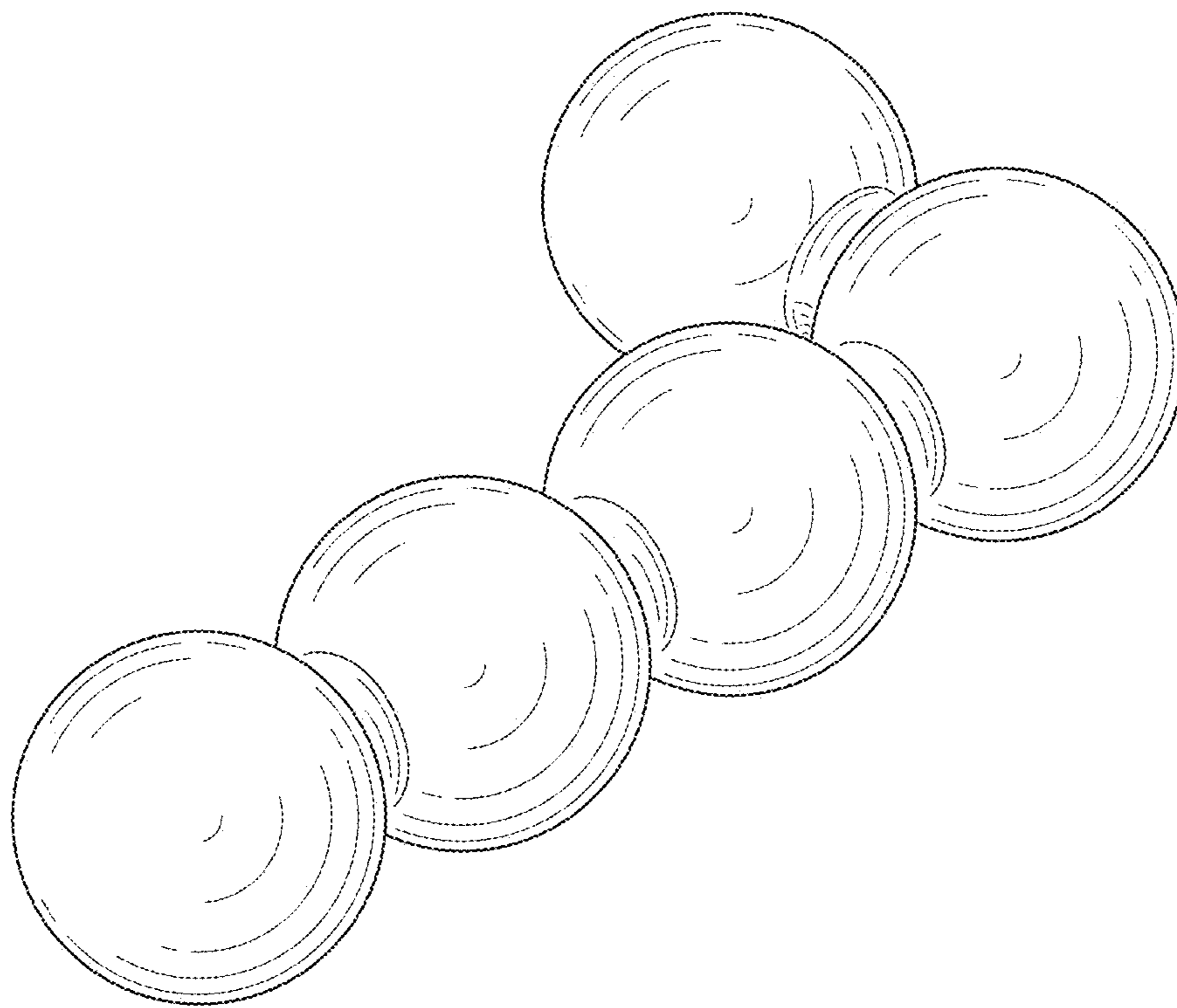

FIG. 78

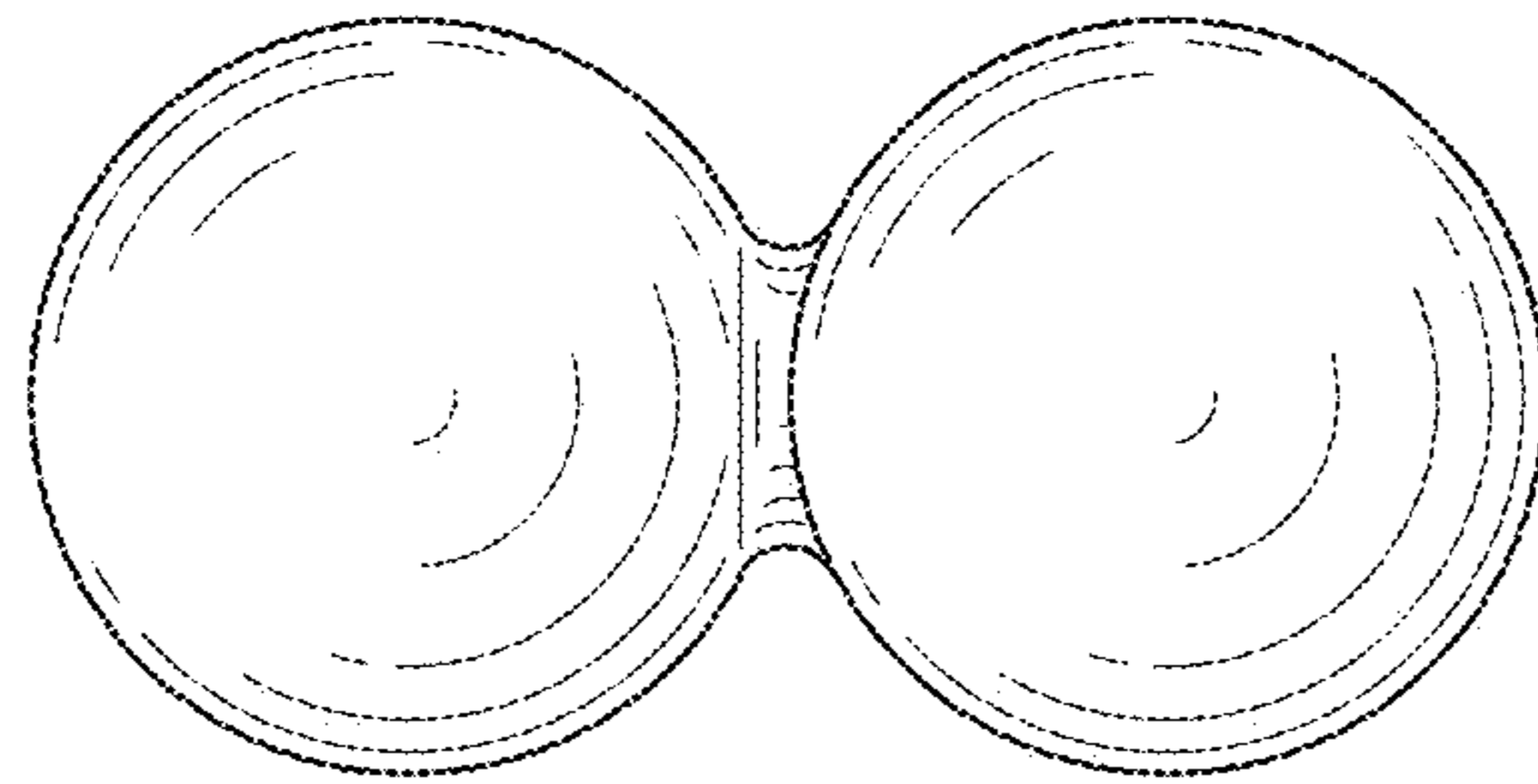

FIG. 79

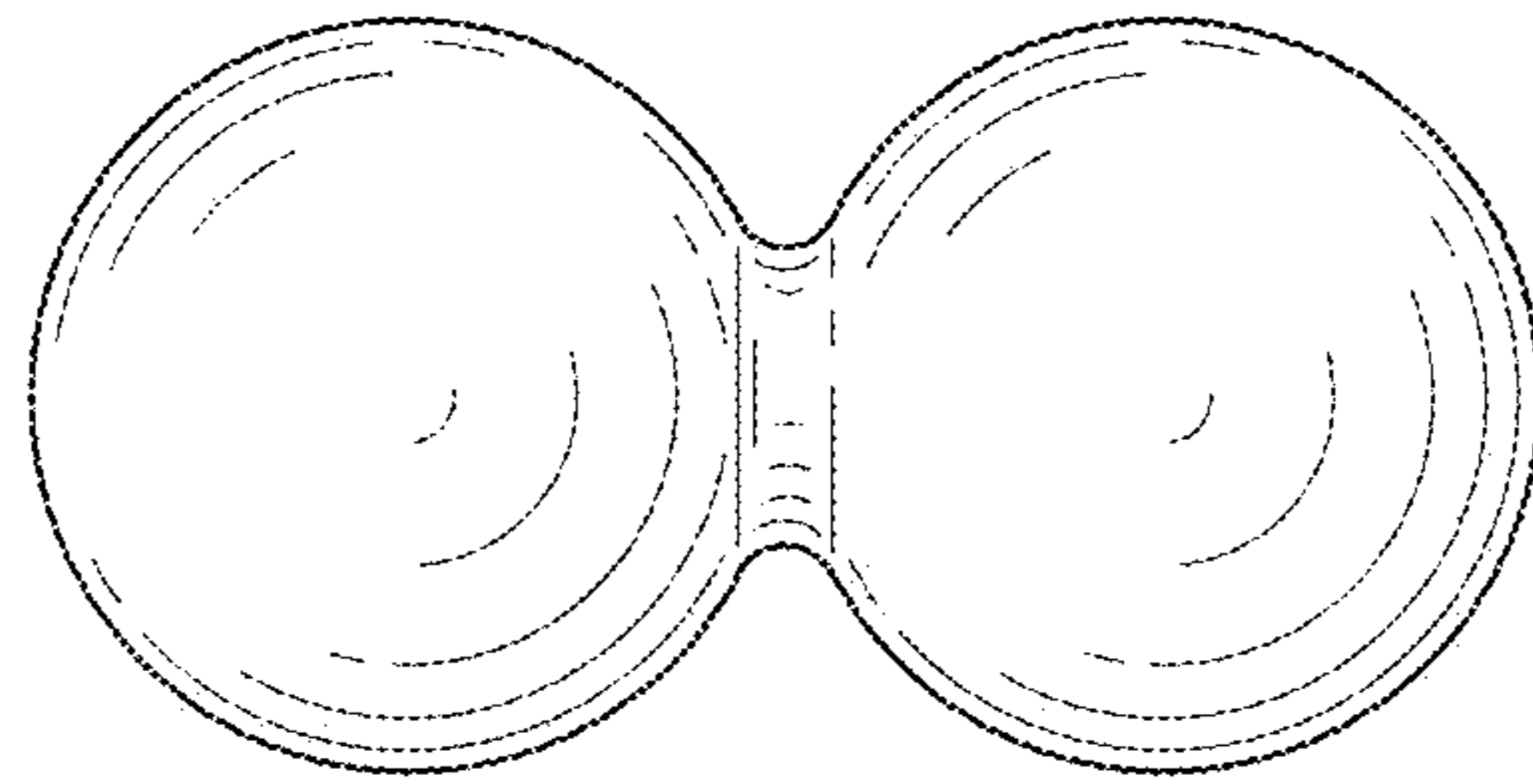

FIG. 80

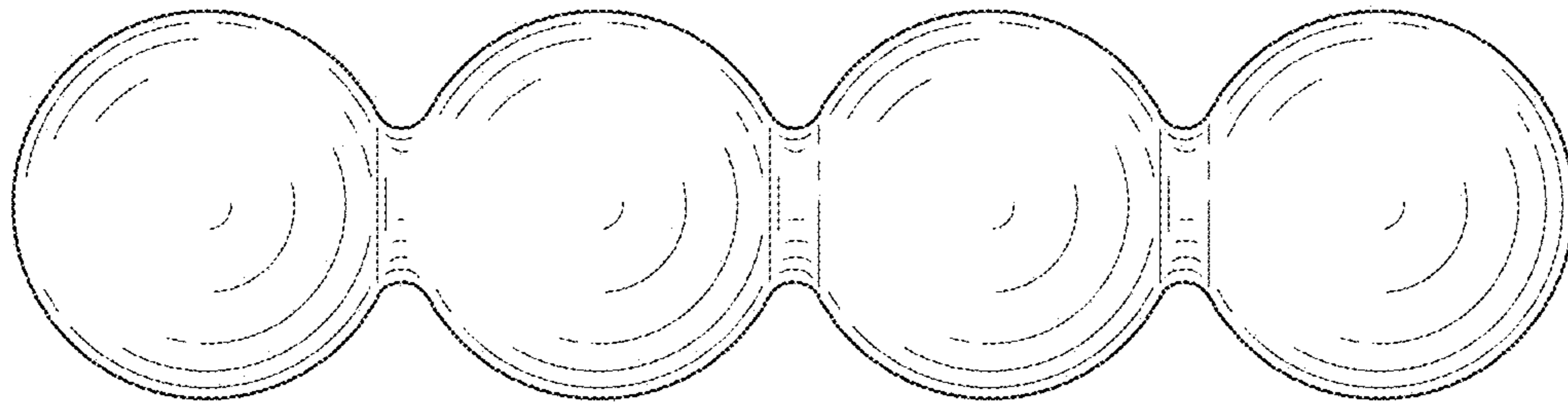

FIG. 81

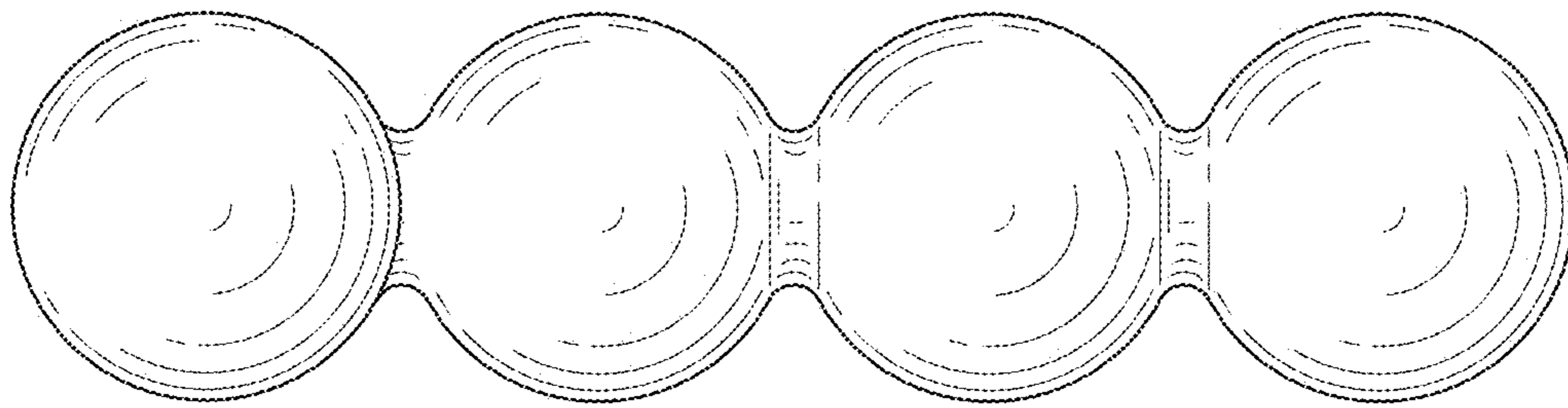

FIG. 82

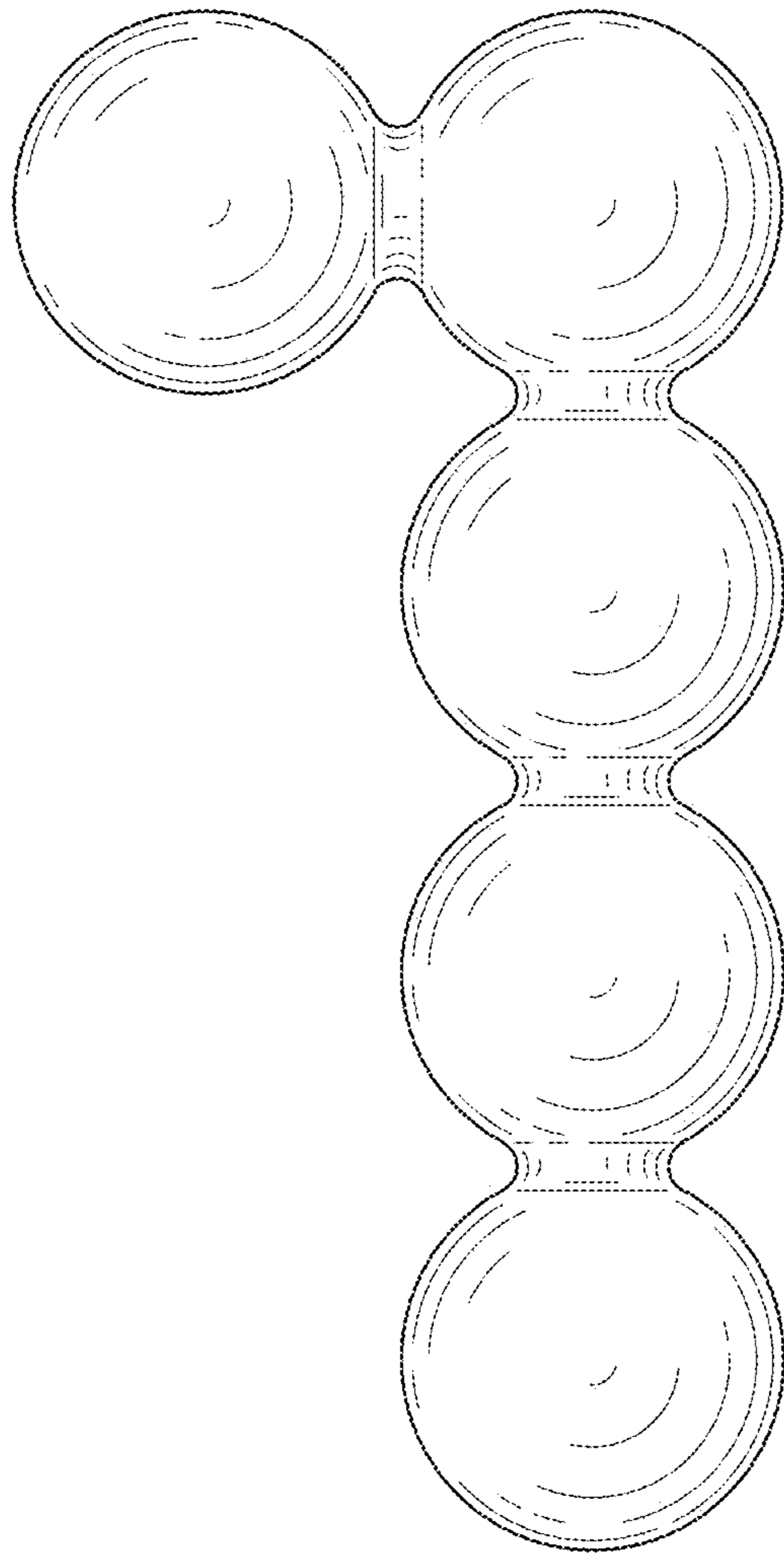

FIG. 83

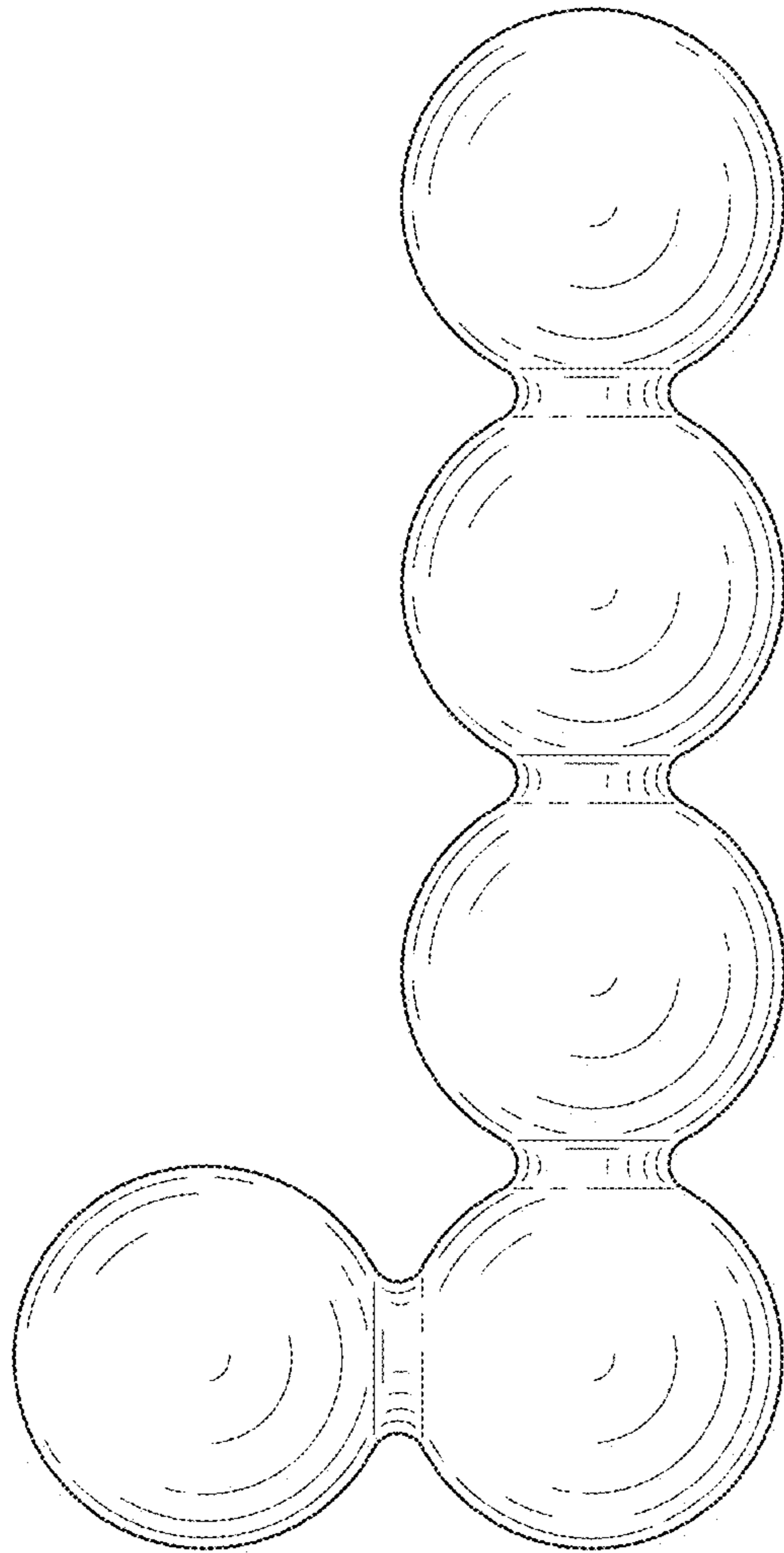

FIG. 84

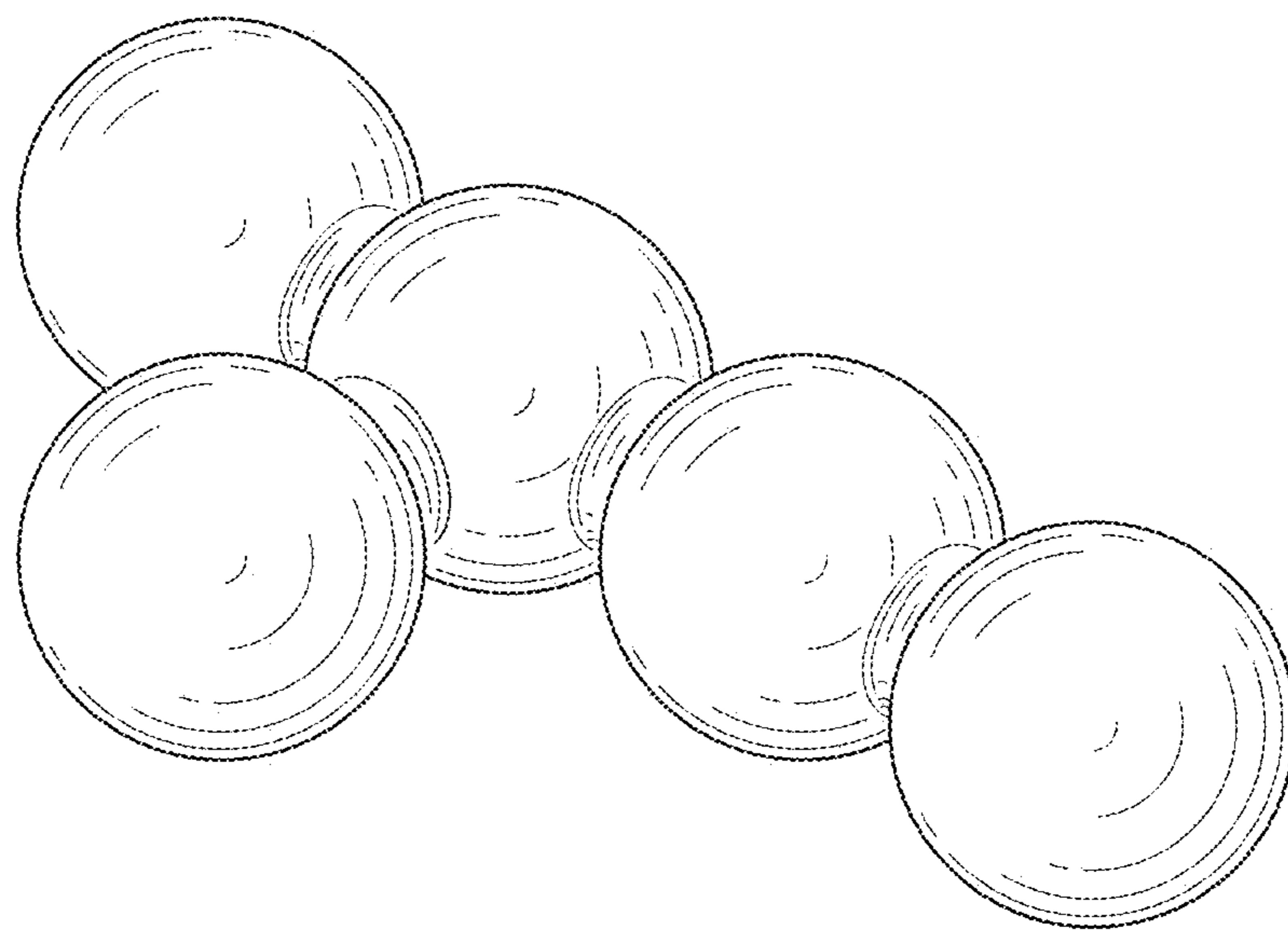

FIG. 85

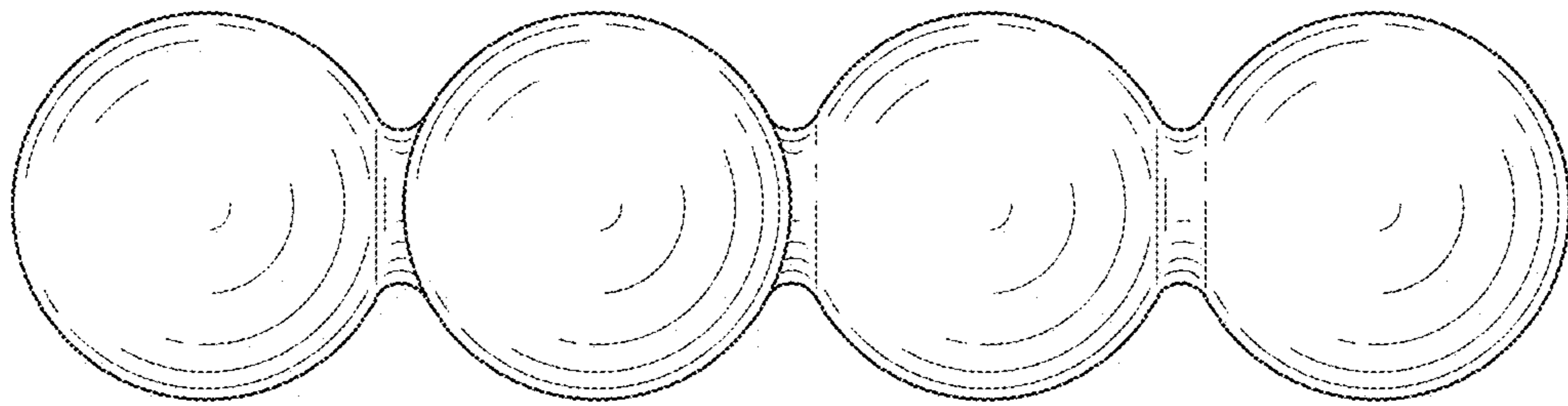

FIG. 86

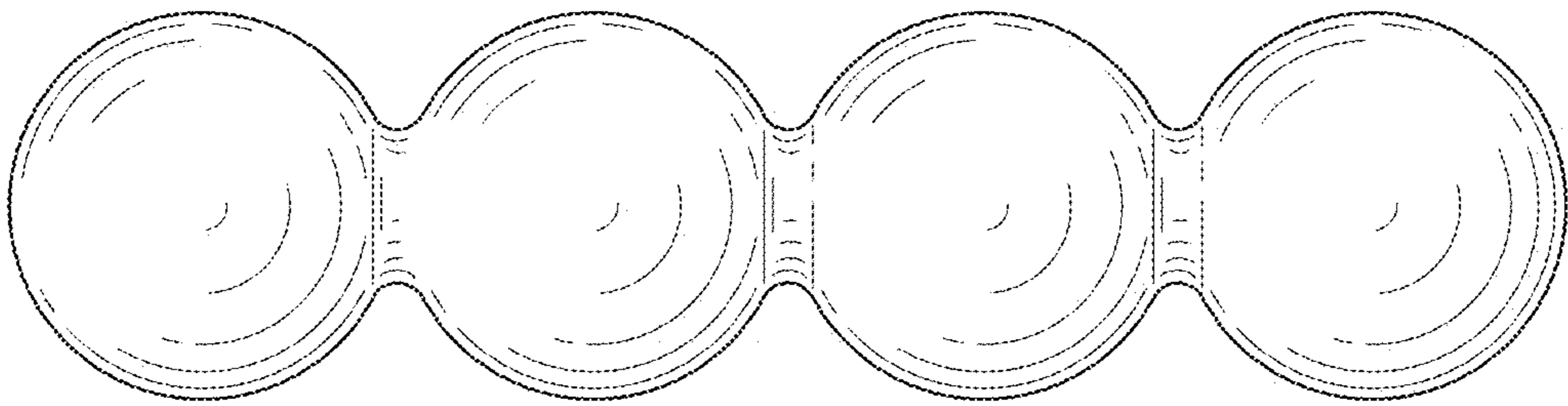

FIG. 87

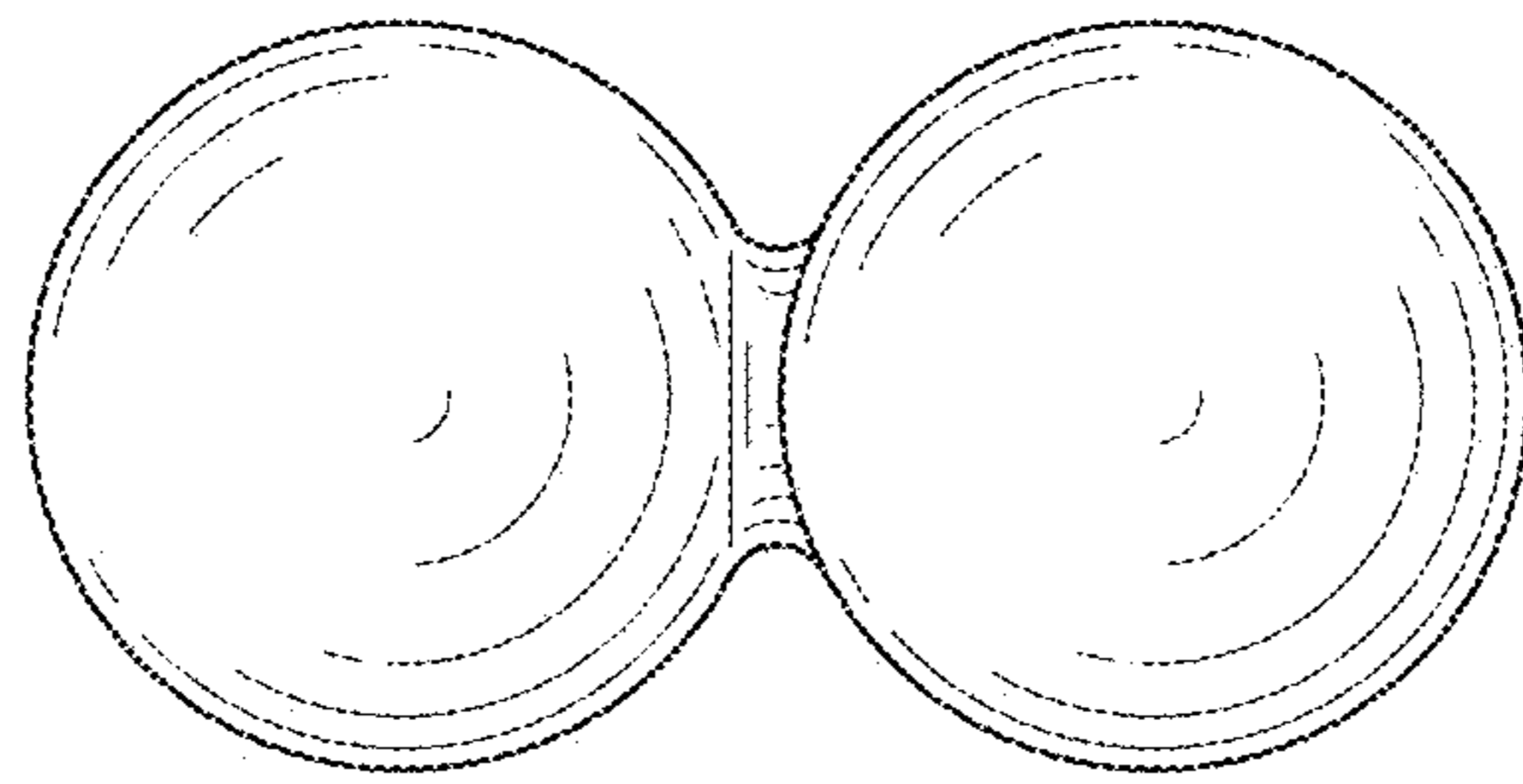

FIG. 88

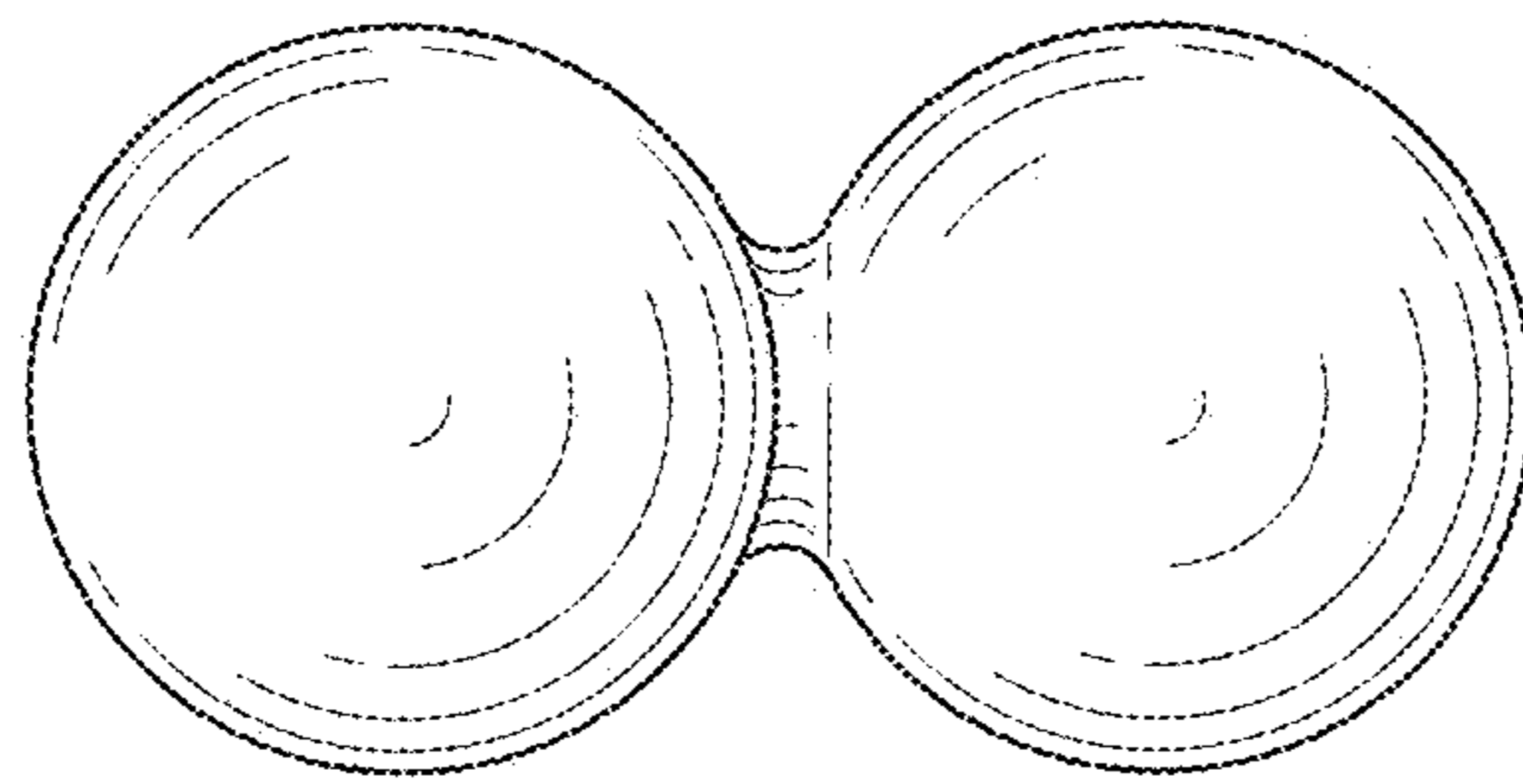

FIG. 89

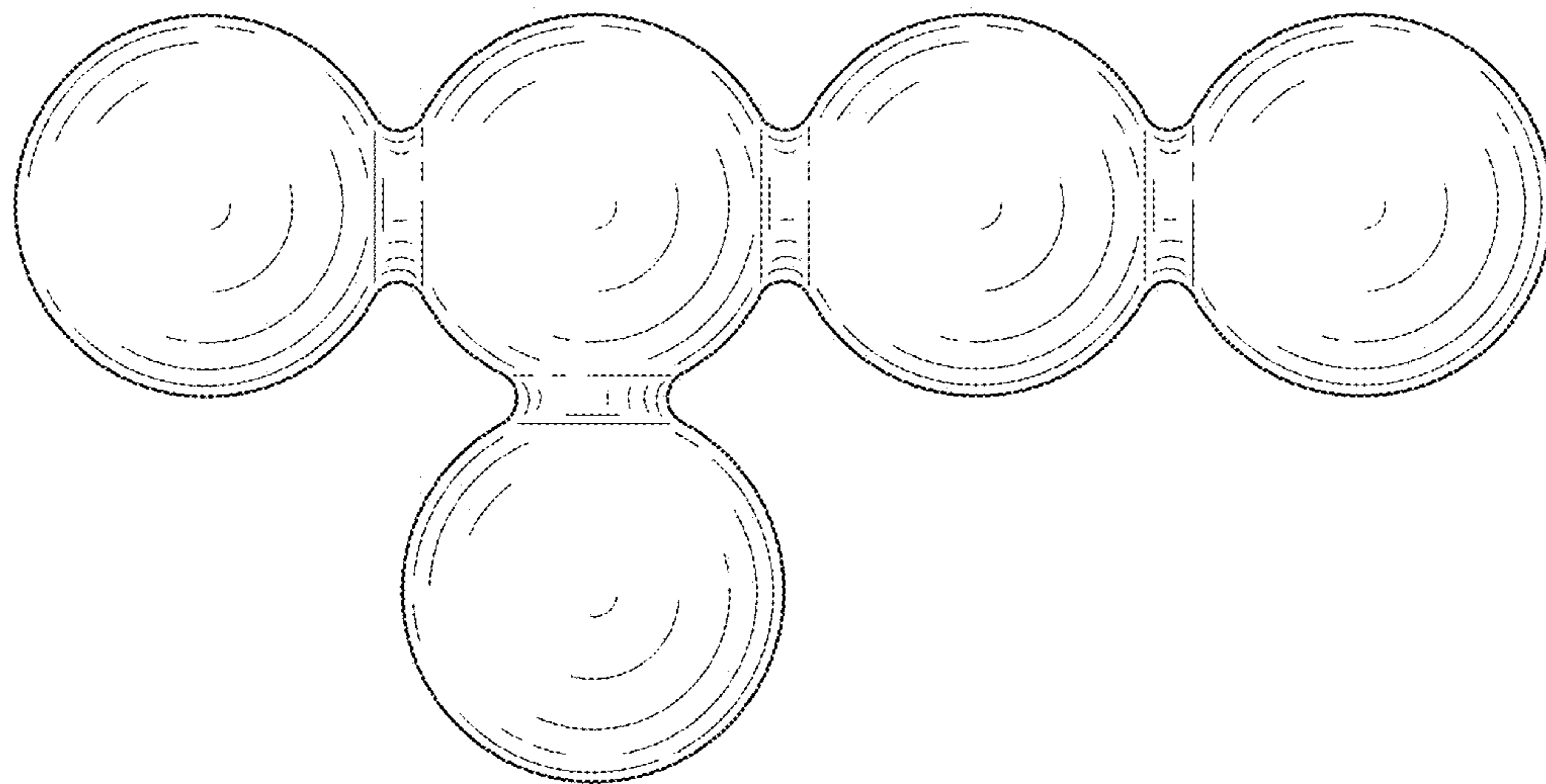

FIG. 90

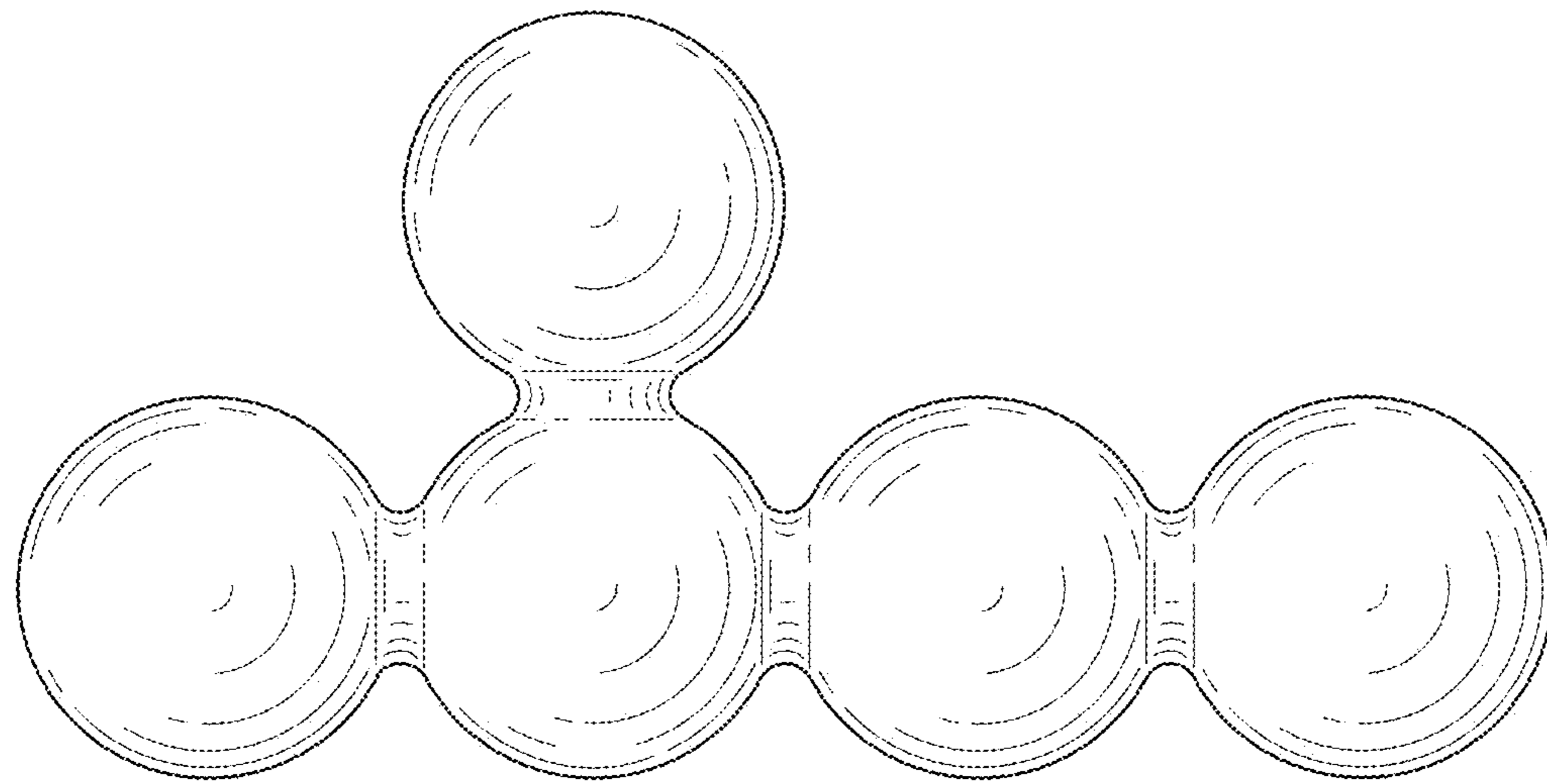

FIG. 91

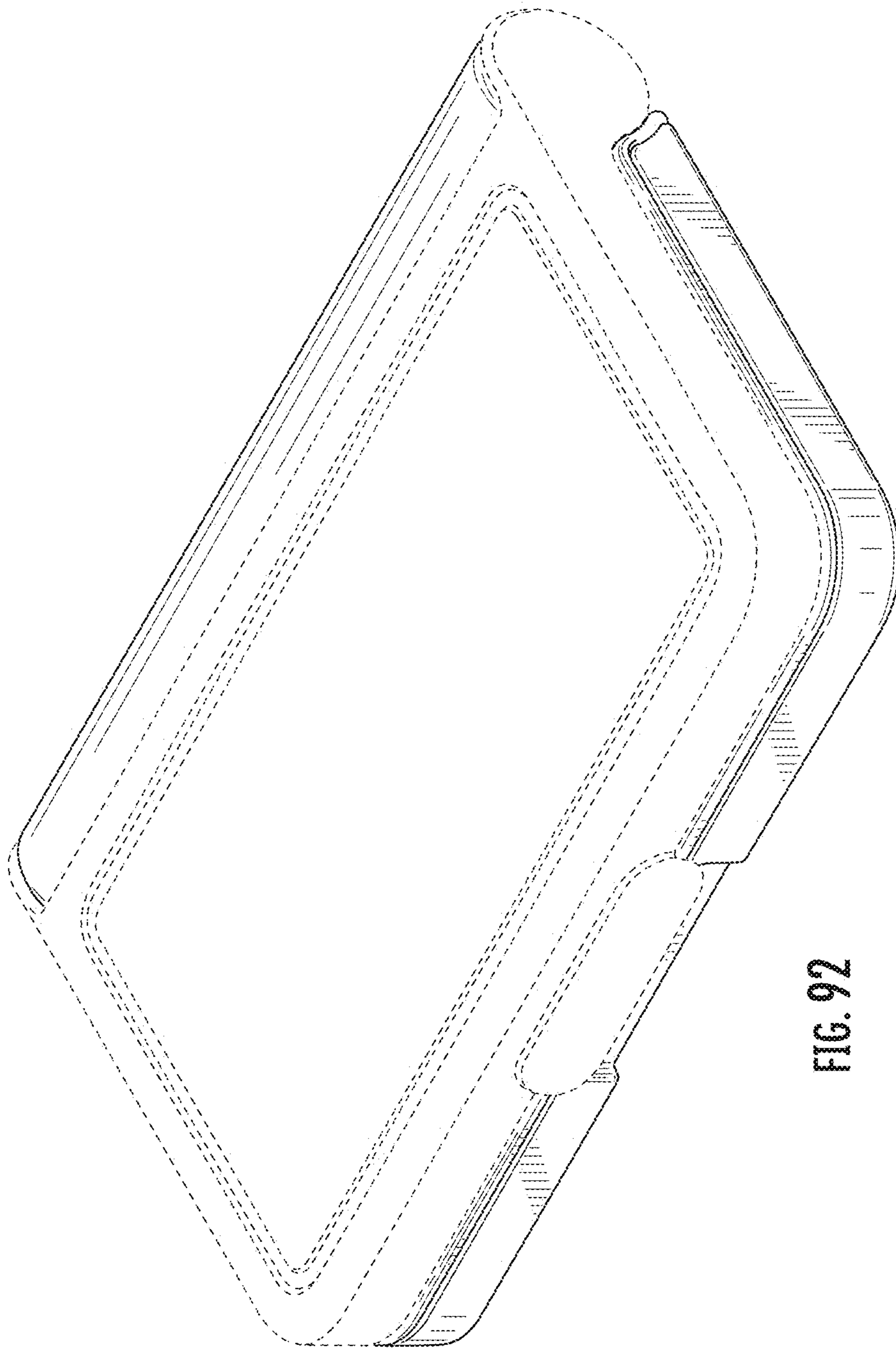

FIG. 92

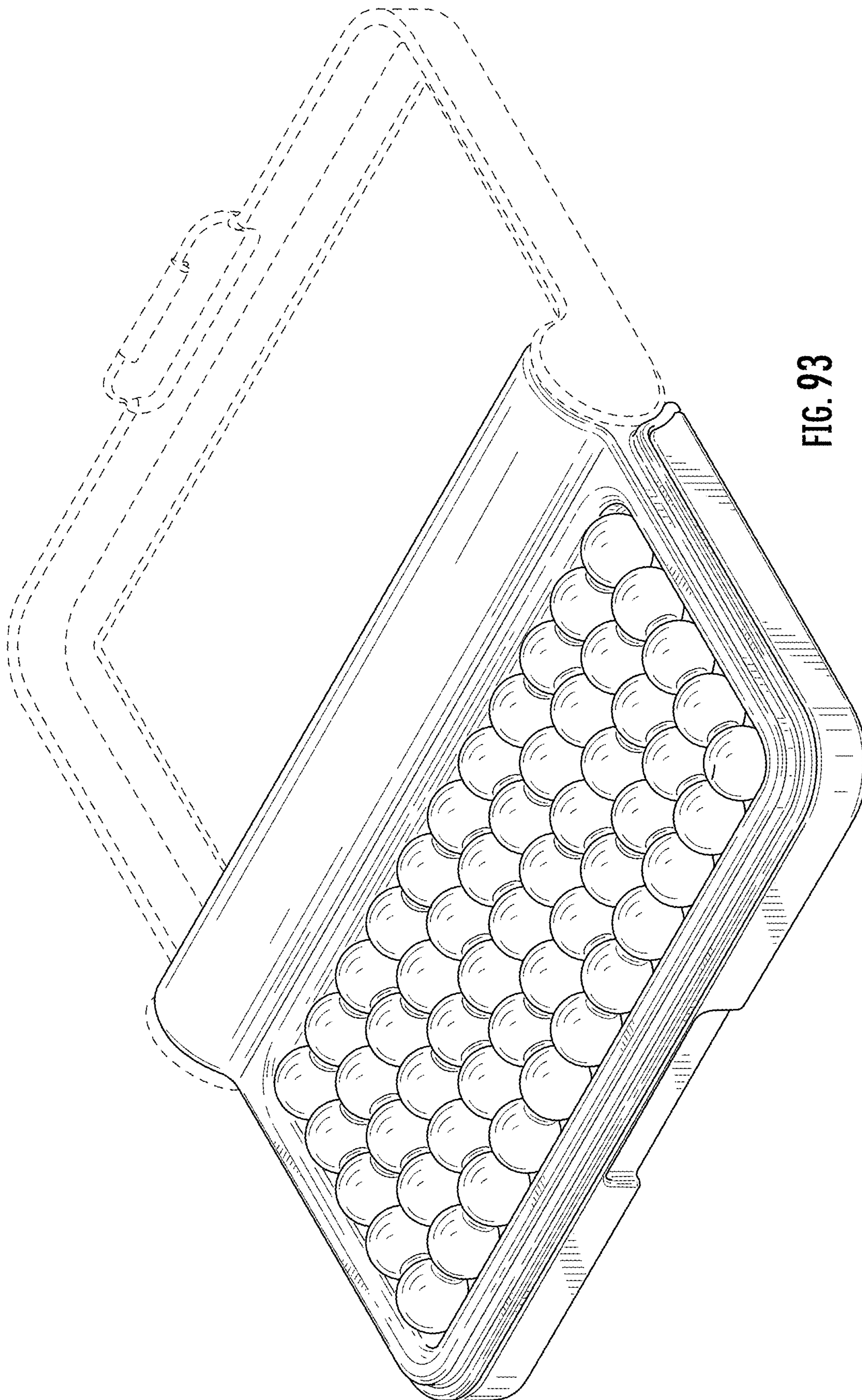

FIG. 93