



US00D911422S

(12) **United States Design Patent**
Johansson

(10) **Patent No.:** **US D911,422 S**

(45) **Date of Patent:** **** Feb. 23, 2021**

(54) **CAMERA STABILIZER**

(71) Applicant: **Easyrig AB**, Umeå (SE)

(72) Inventor: **Lars Johansson**, Umeå (SE)

(**) Term: **15 Years**

(21) Appl. No.: **35/507,736**

(22) Filed: **Mar. 22, 2019**

(80) **Hague Agreement Data**

Int. Filing Date: **Mar. 22, 2019**

Int. Reg. No.: **DM/203947**

Int. Reg. Date: **Mar. 22, 2019**

Int. Reg. Pub. Date: **Nov. 15, 2019**

(51) **LOC (13) Cl.** **16-05**

(52) **U.S. Cl.**

USPC **D16/242**

(58) **Field of Classification Search**

USPC D16/206, 219, 235, 237-245, 250

CPC G03B 17/56; G03B 17/561-568; G02B

7/00-002; H04N 5/2253-2254; F16M

11/04-12; F16M 13/04

See application file for complete search history.

(56) **References Cited**

U.S. PATENT DOCUMENTS

- 4,037,763 A * 7/1977 Turchen F16M 13/04
224/153
- 4,158,490 A * 6/1979 Gottschalk F16M 11/048
224/908
- 4,206,983 A * 6/1980 Nettman A45F 3/10
224/201
- 4,298,149 A * 11/1981 Gottschalk A45F 3/10
224/201
- D338,999 S * 9/1993 Desmith D29/101.1
- 5,360,196 A * 11/1994 DiGiulio F16M 13/04
224/908
- 5,435,515 A * 7/1995 Digiulio F16M 11/10
224/908

- D378,163 S * 2/1997 Clissold D3/218
- 5,829,652 A * 11/1998 Denzer A45F 3/14
224/270
- 5,890,025 A * 3/1999 Hart F16M 13/04
396/420
- 6,056,449 A * 5/2000 Hart F16M 13/04
396/421
- 6,611,662 B1 * 8/2003 Grober A61G 13/10
396/421
- 6,764,231 B1 * 7/2004 Shubert F16M 13/04
396/419
- D714,376 S * 9/2014 Chapman D16/242
- D804,166 S * 12/2017 McCoy D3/216
- 10,401,713 B2 * 9/2019 Teichman F16M 11/046
- D878,753 S * 3/2020 Nolan D3/269
- 2008/0304687 A1 * 12/2008 Howell H04R 1/08
381/362
- 2010/0124414 A1 * 5/2010 Brown F16M 13/04
396/421
- 2010/0254696 A1 * 10/2010 McKay F16M 13/04
396/420
- 2012/0099851 A1 * 4/2012 Brown F16M 13/04
396/421
- 2013/0094847 A1 * 4/2013 Di Leo F16M 13/04
396/421

(Continued)

Primary Examiner — Holly E Thurman

(57)

CLAIM

The ornamental design for a camera stabilizer, as shown and described.

DESCRIPTION

- 1. Camera stabilizer
- 1.1: Perspective
- 1.2: Front
- 1.3: Rear
- 1.4: Right
- 1.5: Left
- 1.6: Bottom
- 1.7: Top

1 Claim, 7 Drawing Sheets

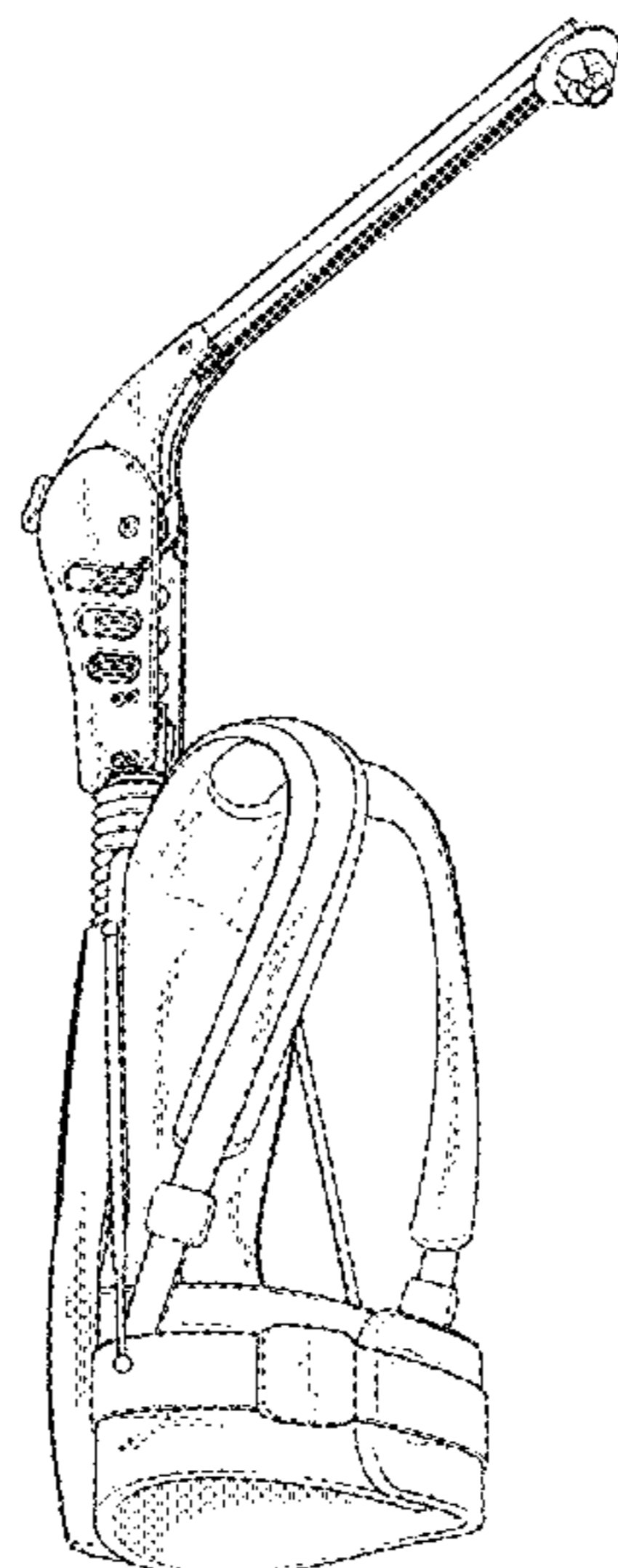

(56)

References Cited

U.S. PATENT DOCUMENTS

2016/0259228 A1* 9/2016 Hellsten G02B 7/002
2017/0108168 A1* 4/2017 Pan F16M 11/16
2017/0231370 A1* 8/2017 Crimaldi A45F 3/08
224/637
2018/0084893 A1* 3/2018 Landano A45F 3/10

* cited by examiner

1.1

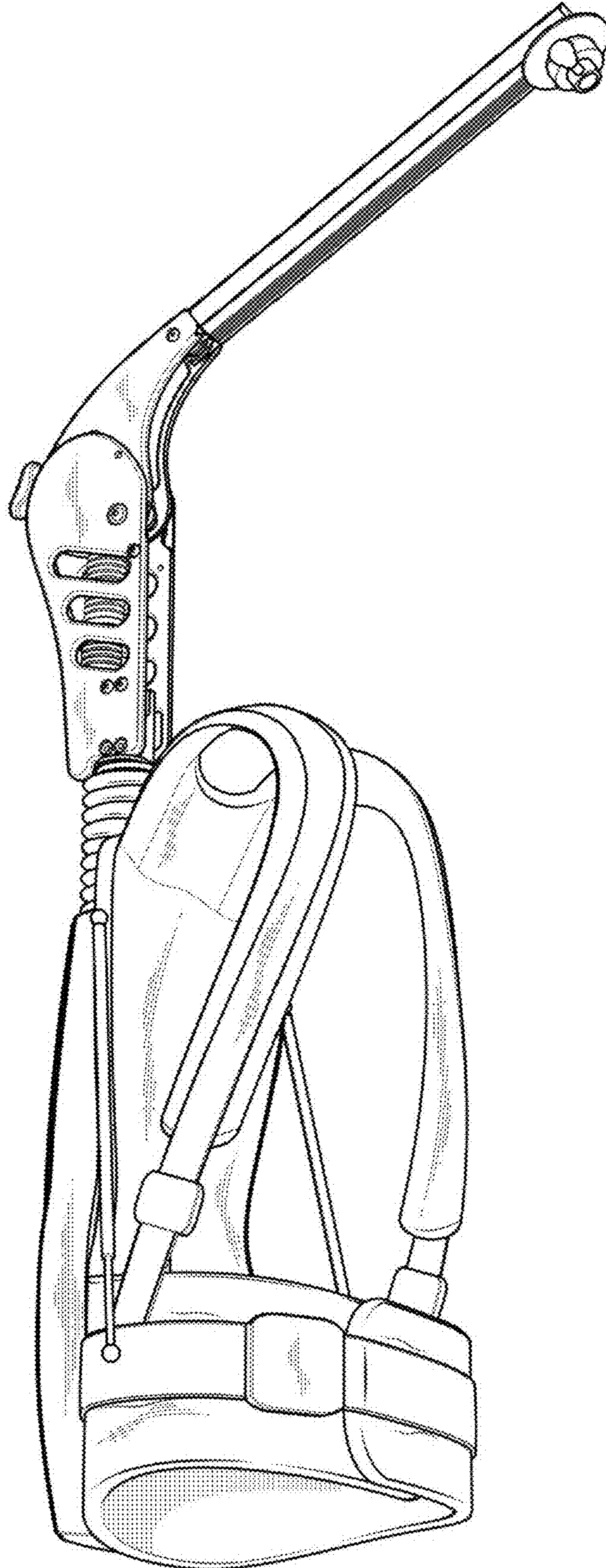

1.2

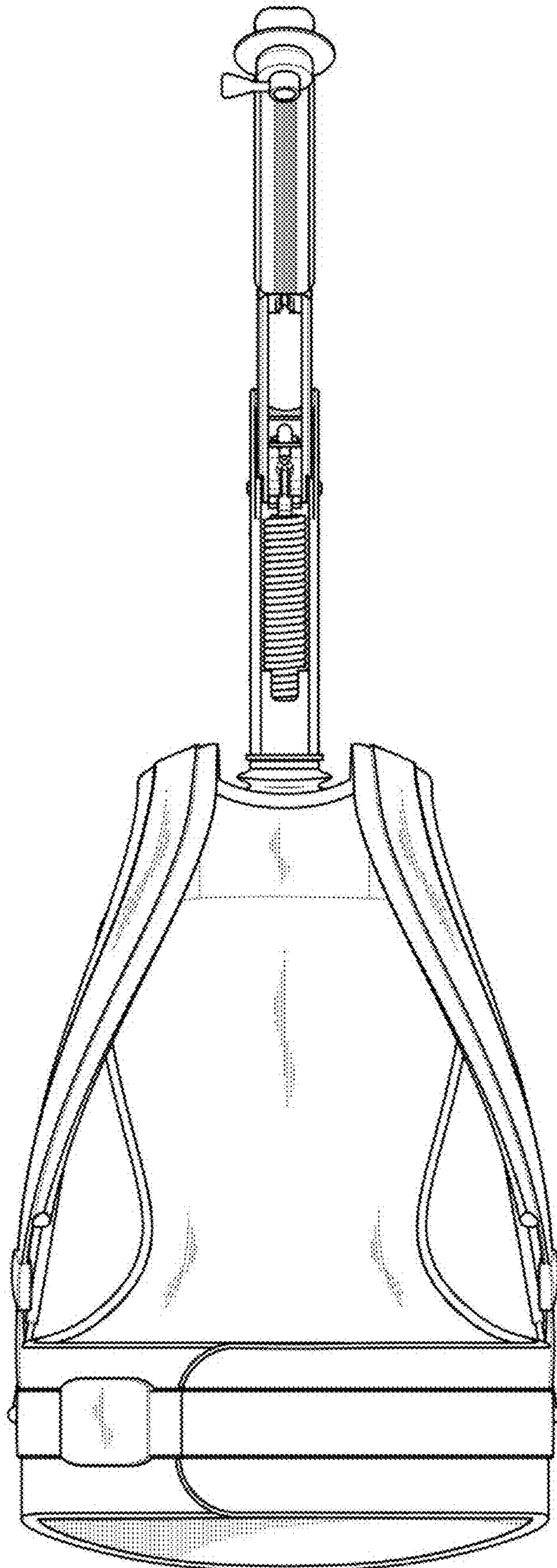

1.3

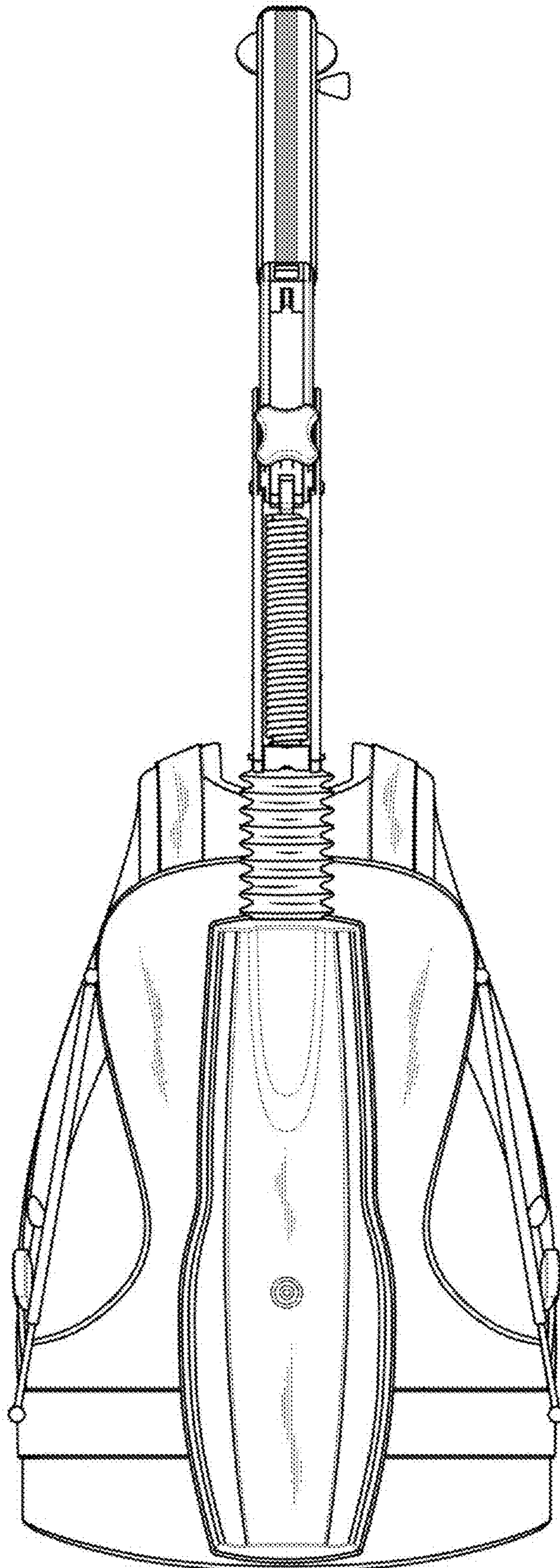

1.4

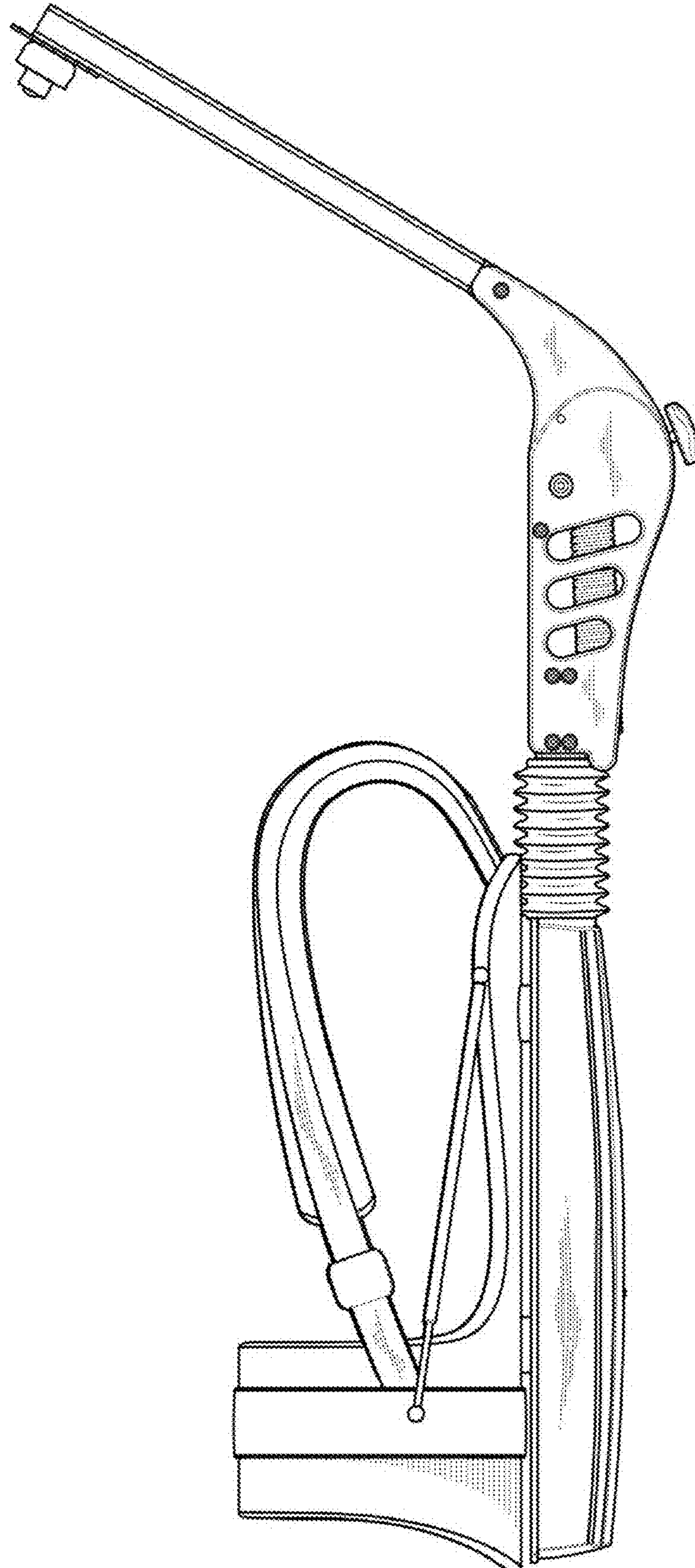

1.5

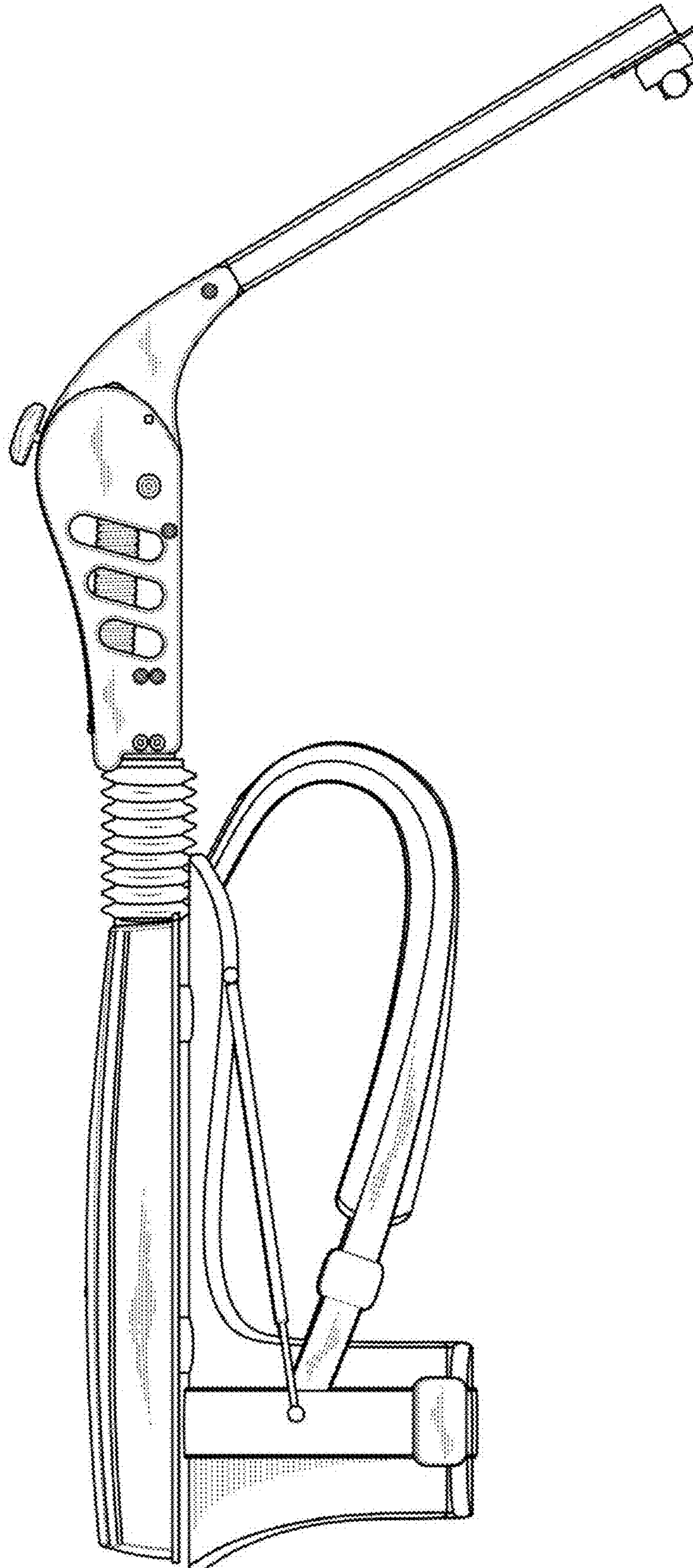

1.6

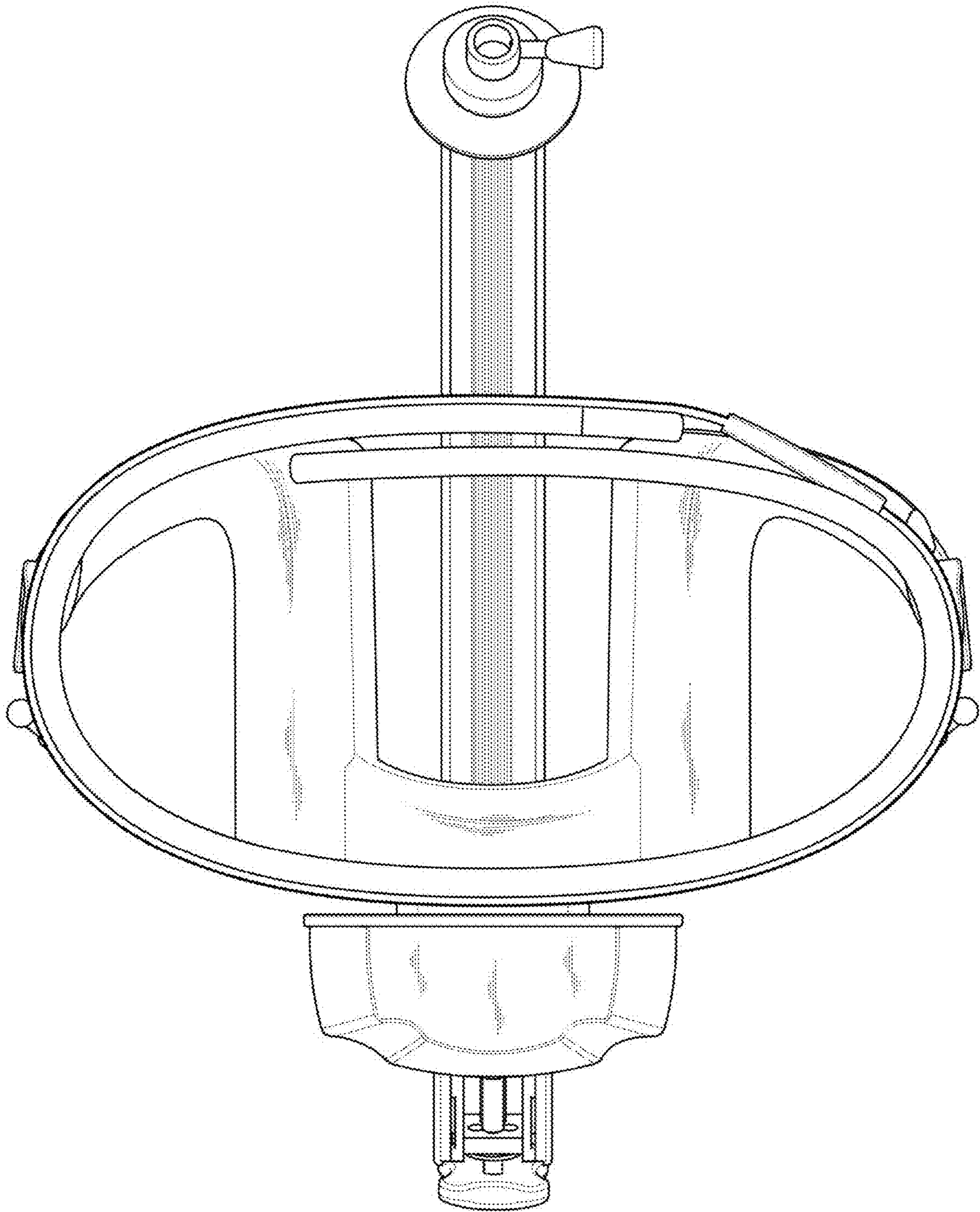

1.7

