

US00D911321S

(12) **United States Design Patent** (10) **Patent No.:** **US D911,321 S**
Pantel (45) **Date of Patent:** **** Feb. 23, 2021**

- (54) **SMARTPHONE**
- (71) Applicant: **Lothar Pantel**, Neckargemuend (DE)
- (72) Inventor: **Lothar Pantel**, Neckargemuend (DE)
- (73) Assignee: **inodyn NewMedia GmbH**,
Neckargemuend (DE)
- (**) Term: **15 Years**
- (21) Appl. No.: **29/655,228**
- (22) Filed: **Jul. 1, 2018**

D717,263 S	11/2014	Wozniak	
D726,673 S *	4/2015	Lee	D14/138 G
D730,863 S	6/2015	Yamagishi et al.	
D734,326 S	7/2015	McManigal	
D738,027 S *	9/2015	Wang	D26/85
D738,840 S *	9/2015	Kim	D14/138 G
D747,694 S *	1/2016	Tom	D14/138 G
D747,713 S	1/2016	Choi et al.	
D749,551 S	2/2016	Mitchell	
D752,040 S	3/2016	Cebe et al.	
D762,628 S	8/2016	Yoon et al.	
D763,837 S *	8/2016	Choe	D14/248
9,405,391 B1	8/2016	Mackraz	
D767,563 S	9/2016	Satzger et al.	
D772,835 S	11/2016	Kim et al.	
D775,597 S	1/2017	Kim et al.	
D776,108 S	1/2017	Hsu	
D777,700 S	1/2017	Kwon et al.	
D780,147 S	2/2017	Song	
D780,710 S	3/2017	Song	
D783,565 S	4/2017	Kim et al.	
D783,566 S	4/2017	Kim et al.	
D783,586 S *	4/2017	Park	D14/248
D784,281 S	4/2017	Ryu et al.	
D784,314 S	4/2017	Ryu et al.	
D786,214 S	5/2017	Kwon et al.	
D788,731 S	6/2017	Park et al.	
D791,730 S *	7/2017	Li	D14/138 G
D794,004 S	8/2017	Kwon et al.	
D794,623 S	8/2017	Kwon et al.	
D798,263 S	9/2017	Kwon et al.	
D810,713 S	2/2018	Pantel	
D820,232 S *	6/2018	Shin	D14/138 G
D820,800 S *	6/2018	Song	D14/138 G
D820,831 S *	6/2018	Kim	D14/341
D820,832 S *	6/2018	Kim	D14/341
D820,835 S *	6/2018	Kim	D14/341
D821,389 S *	6/2018	Kim	D14/341
D827,637 S *	9/2018	Kim	D14/341
D829,206 S *	9/2018	Akana	D14/341
D830,987 S *	10/2018	Choe	D14/138 G
D834,552 S *	11/2018	Ryu	D14/138 G
D836,592 S *	12/2018	Cho	D14/138 AA
D840,962 S *	2/2019	Song	D14/138 G
D840,964 S *	2/2019	Song	D14/138 G
D847,128 S	4/2019	Kim et al.	
D847,809 S *	5/2019	Akana	D14/341
D849,705 S *	5/2019	Boucquey	D14/138 AA
D850,402 S *	6/2019	Cho	D14/138 G
D851,085 S *	6/2019	Kim	D14/341
D853,980 S *	7/2019	Kim	D14/138 G
D854,524 S	7/2019	Choi et al.	
D857,009 S *	8/2019	Kim	D14/341

- Related U.S. Application Data**
- (63) Continuation-in-part of application No. 29/644,284,
filed on Apr. 16, 2018.

- Foreign Application Priority Data**
- May 31, 2018 (EM) 005291838

- (51) **LOC (13) Cl.** **14-03**
- (52) **U.S. Cl.**
USPC **D14/248**

- (58) **Field of Classification Search**
USPC D14/248, 315-318, 341, 342, 345, 203.1,
D14/203.3, 203.7, 371, 496, 388, 389,
D14/507, 165, 250; D6/308, 310
CPC G06F 1/1613; G06F 1/1647; G06F 1/1641;
G06F 3/04883; G06F 3/0486; G06F
3/04847; G06F 3/04845; G06F 3/04817;
G06F 3/0484; H04M 1/0279; H04M
1/0281; H04M 1/0283
See application file for complete search history.

- (56) **References Cited**
U.S. PATENT DOCUMENTS
D645,833 S 9/2011 Seflic et al.
D665,763 S 8/2012 Tsai et al.
D693,787 S 11/2013 Reivo et al.
D695,250 S 12/2013 Kim et al.
D703,644 S * 4/2014 Song D14/248

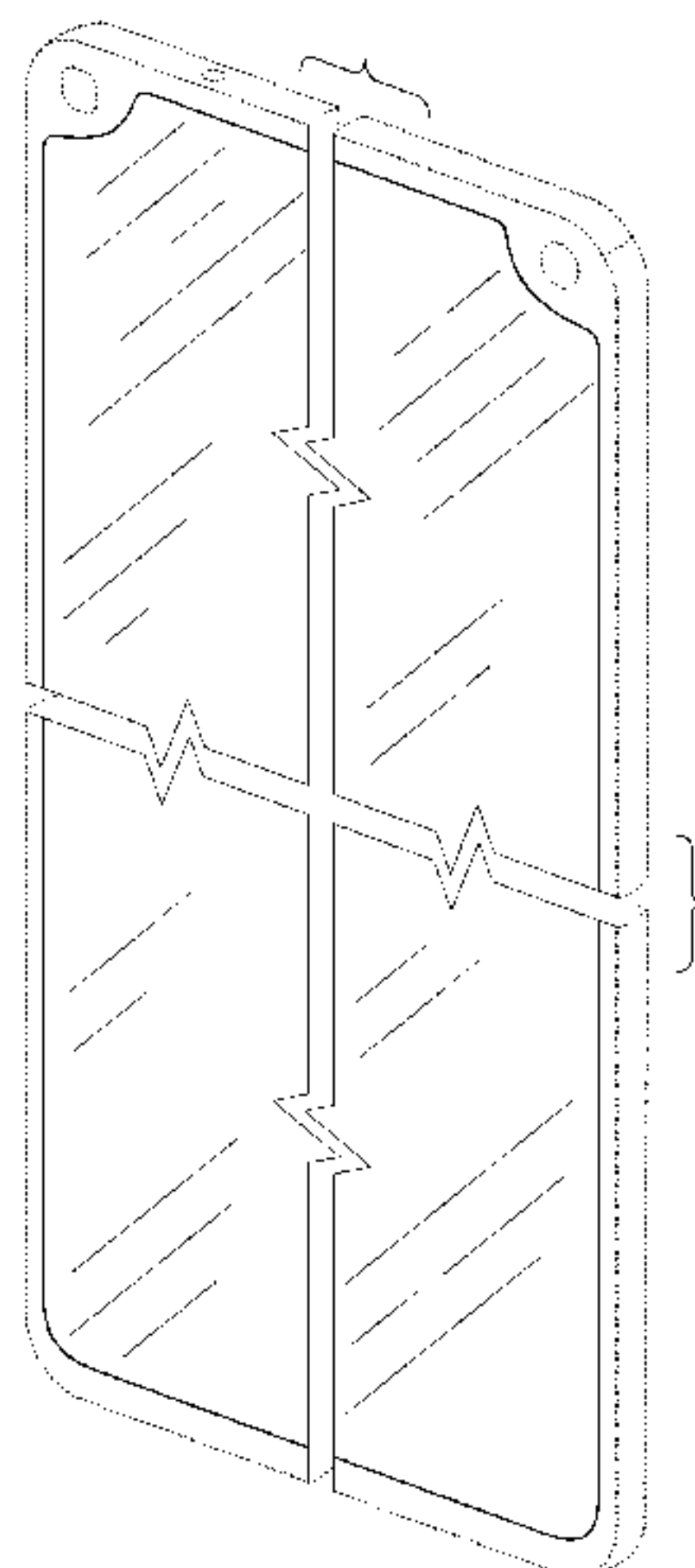

D857,690	S	*	8/2019	Kim	D14/341
D861,673	S	*	10/2019	Kim	D14/341
D861,674	S	*	10/2019	Kim	D14/341
D862,457	S	*	10/2019	Kim	D14/341
D862,458	S	*	10/2019	Kim	D14/341
D863,293	S	*	10/2019	Kim	D14/341
D864,197	S	*	10/2019	Kim	D14/341
D864,954	S	*	10/2019	Kim	D14/341
D865,732	S	*	11/2019	Park	D14/248
D865,734	S	*	11/2019	Park	D14/248
D865,735	S	*	11/2019	Park	D14/248
D866,499	S	*	11/2019	Shin	D14/138 G
D866,500	S	*	11/2019	Shin	D14/138 G
D866,540	S	*	11/2019	Park	D14/248
D866,549	S	*	11/2019	Kim	D14/341
D866,550	S	*	11/2019	Kim	D14/341
D872,044	S	*	1/2020	Lee	D14/138 G
D876,431	S	*	2/2020	Pendse	D14/341
2012/0032979	A1		2/2012	Blow et al.		
2014/0170397	A1		6/2014	Shen et al.		
2014/0325435	A1		10/2014	Jung et al.		
2015/0185055	A1*		7/2015	King	G01D 11/245 361/679.01
2015/0317020	A1		11/2015	Watanabe et al.		
2015/0364109	A1		12/2015	Jain et al.		
2016/0161664	A1		6/2016	Ishida et al.		
2017/0004798	A1		1/2017	Park et al.		
2017/0069956	A1*		3/2017	Hill	H04M 1/0249
2017/0123454	A1		5/2017	Evans, V et al.		
2017/0123575	A1		5/2017	Evans, V et al.		
2017/0126868	A1		5/2017	Evans, V et al.		
2017/0126979	A1		5/2017	Evans, V et al.		
2017/0162111	A1		6/2017	Kang et al.		

FOREIGN PATENT DOCUMENTS

AU	201716792	S	11/2017
AU	201716793	S	11/2017
DE	402017202114	S	10/2017
DE	402017203592	S	2/2018
DE	402017203595	S	2/2018
EM	004013787	S	7/2017
EM	004494417	S	11/2017
GB	6032901	S	4/2018
GB	6032902	S	4/2018
GB	6032903	S	4/2018
GB	6032904	S	4/2018
GB	6032905	S	4/2018
GB	6032906	S	4/2018
GB	6032907	S	4/2018
GB	6032908	S	4/2018
GB	6032909	S	4/2018
GB	6032910	S	4/2018
GB	6032911	S	4/2018
GB	6032912	S	4/2018
GB	6032913	S	4/2018
GB	6032914	S	4/2018
GB	6032915	S	4/2018
GB	6032916	S	4/2018
GB	6032917	S	4/2018
GB	6032918	S	4/2018
GB	6032919	S	4/2018
GB	6032920	S	4/2018

OTHER PUBLICATIONS

Early publication of UK patent application GB 2552090 A (UK IPO application No. 1710466.2) Inventor/author: Lothar Pantel; Title: "Front-facing camera and maximized display screen of a mobile

device" Published by the inventor/applicant of the present application. Available online from: <http://www.earlypublication.com> Publication Date (on "earlypublication.com"): Jul. 3, 2017; Twelve-Month Grace Period Applies.

Alex Hern, May 30, 2017, "Android co-founder reveals new smartphone to take on Apple and Samsung," The Guardian, Available online from: <https://www.theguardian.com/technology/2017/may/30/essential-phone-android-co-founder-reveals-new-smartphone-apple-samsung>.

Samuel Gibbs, Nov. 10, 2017, "iPhone X review: Apple finally knocks it out of the park," The Guardian, Available online from: <https://www.theguardian.com/technology/2017/nov/10/iphone-x-review-apple-face-id-all-screen-design-home-button>.

* cited by examiner

Primary Examiner — Mark A Goodwin

Assistant Examiner — Benjamin M Weeks

(57)

CLAIM

The ornamental design for a smartphone, as shown and described.

DESCRIPTION

This application is related to U.S. design application Ser. No. 29/539,390, filed Sep. 14, 2015, now U.S. Pat. No. D810,713 S, U.S. design application Ser. No. 29/624,858, filed Nov. 3, 2017, U.S. design application Ser. No. 29/624,864, filed Nov. 3, 2017, and U.S. design application Ser. No. 29/644,278, filed Apr. 16, 2018.

FIG. 1 is a top right front perspective view of a first embodiment of a smartphone showing my new design;

FIG. 2 is a front elevation view thereof;

FIG. 3 is a rear elevation view thereof;

FIG. 4 is a left side elevation view thereof, the right side being a mirror image thereof;

FIG. 5 is a top plan view thereof;

FIG. 6 is a bottom plan view thereof;

FIG. 7 is another front elevation view thereof, showing environment in a state of use;

FIG. 8 is a top right front perspective view of a second embodiment thereof;

FIG. 9 is a front elevation view thereof;

FIG. 10 is a rear elevation view thereof;

FIG. 11 is a left side elevation view thereof, the right side being a mirror image thereof;

FIG. 12 is a top plan view thereof;

FIG. 13 is a bottom plan view thereof; and,

FIG. 14 is another front elevation view thereof, showing environment in a state of use.

Features shown in broken or dotted lines as well as break lines and associated curly brackets form no part of the claimed design. Oblique shade lines show a transparent, reflective, or shiny surface, and not surface ornamentation. The break lines in the drawings indicate undetermined length and width of the claimed design, and the appearance of any portion of the smartphone between the break lines forms no part of the claimed design.

1 Claim, 8 Drawing Sheets

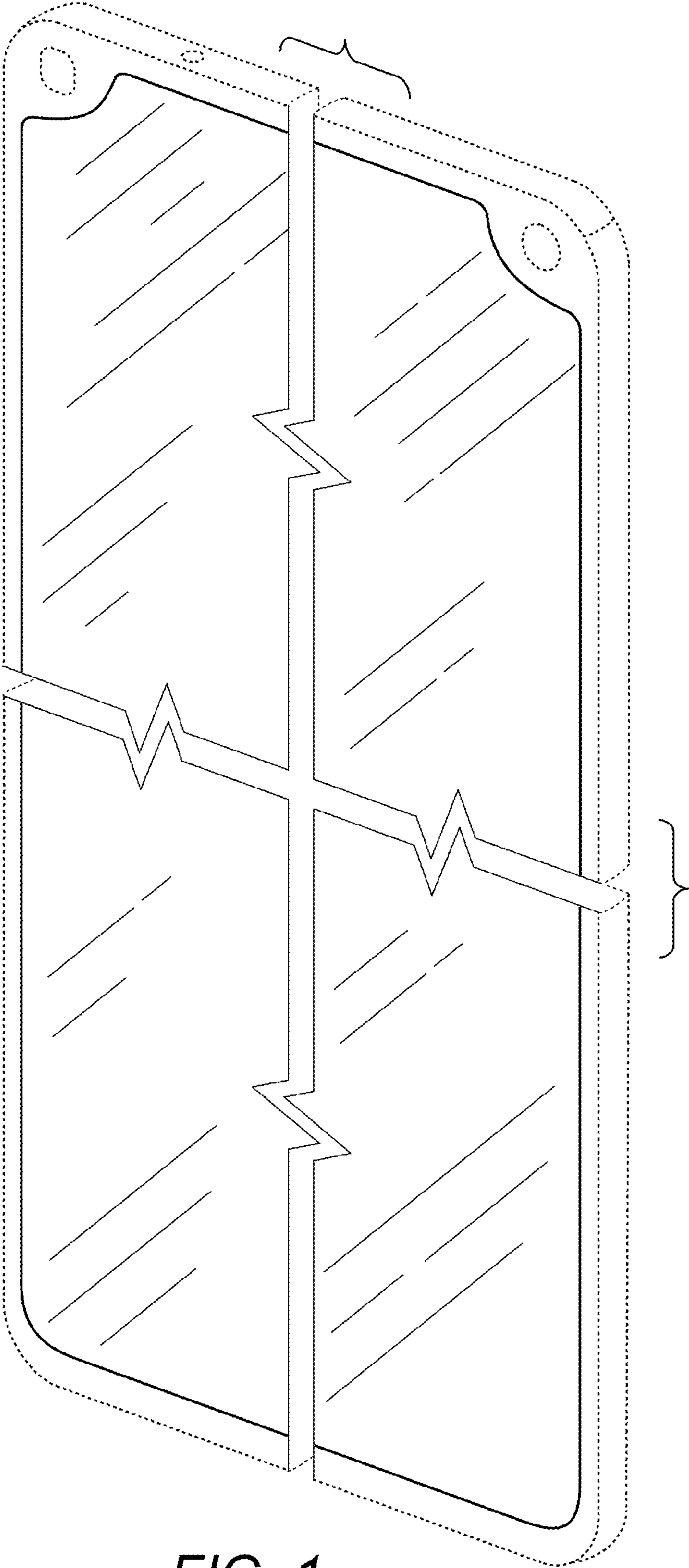

FIG. 1

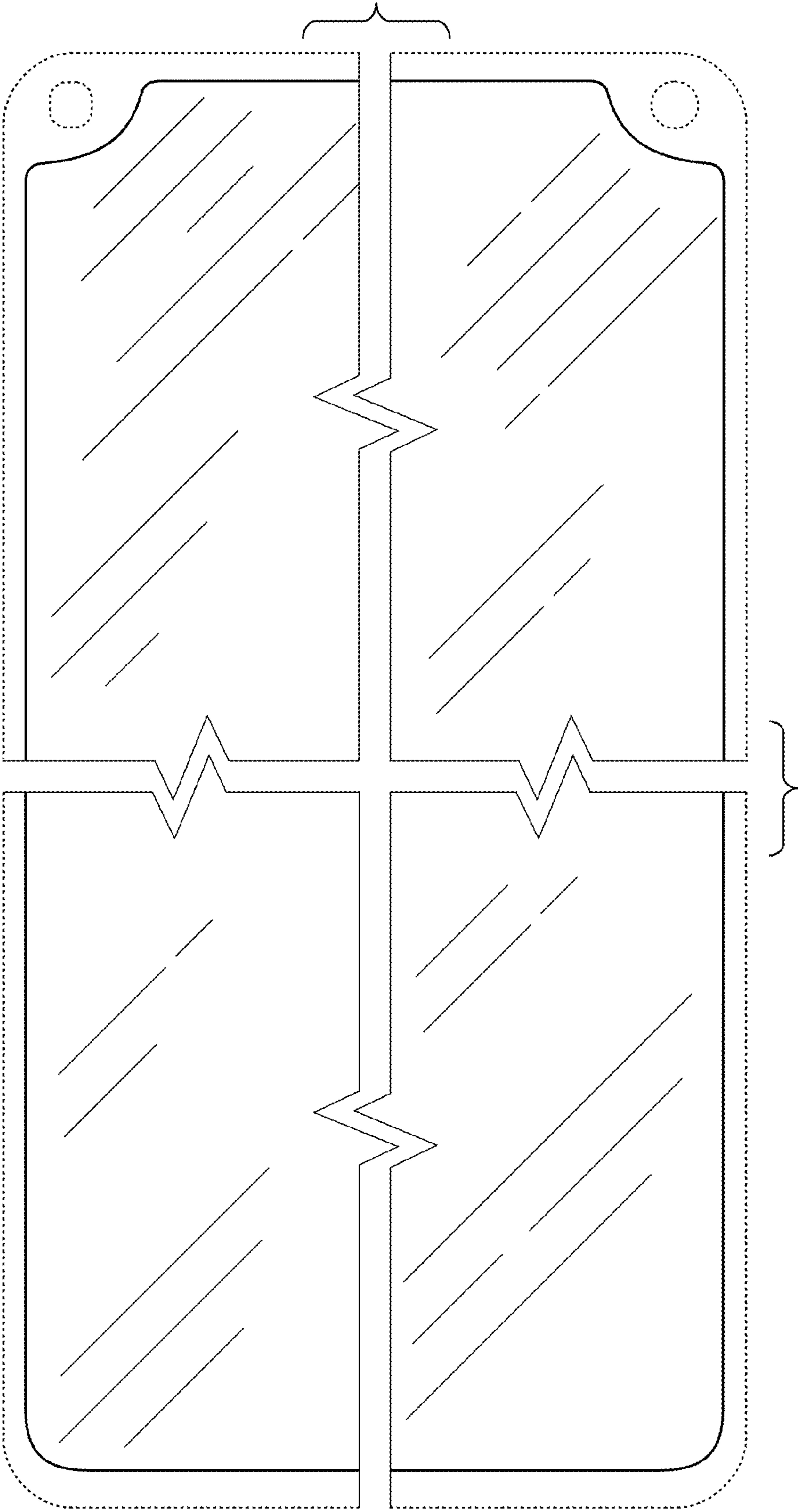

FIG. 2

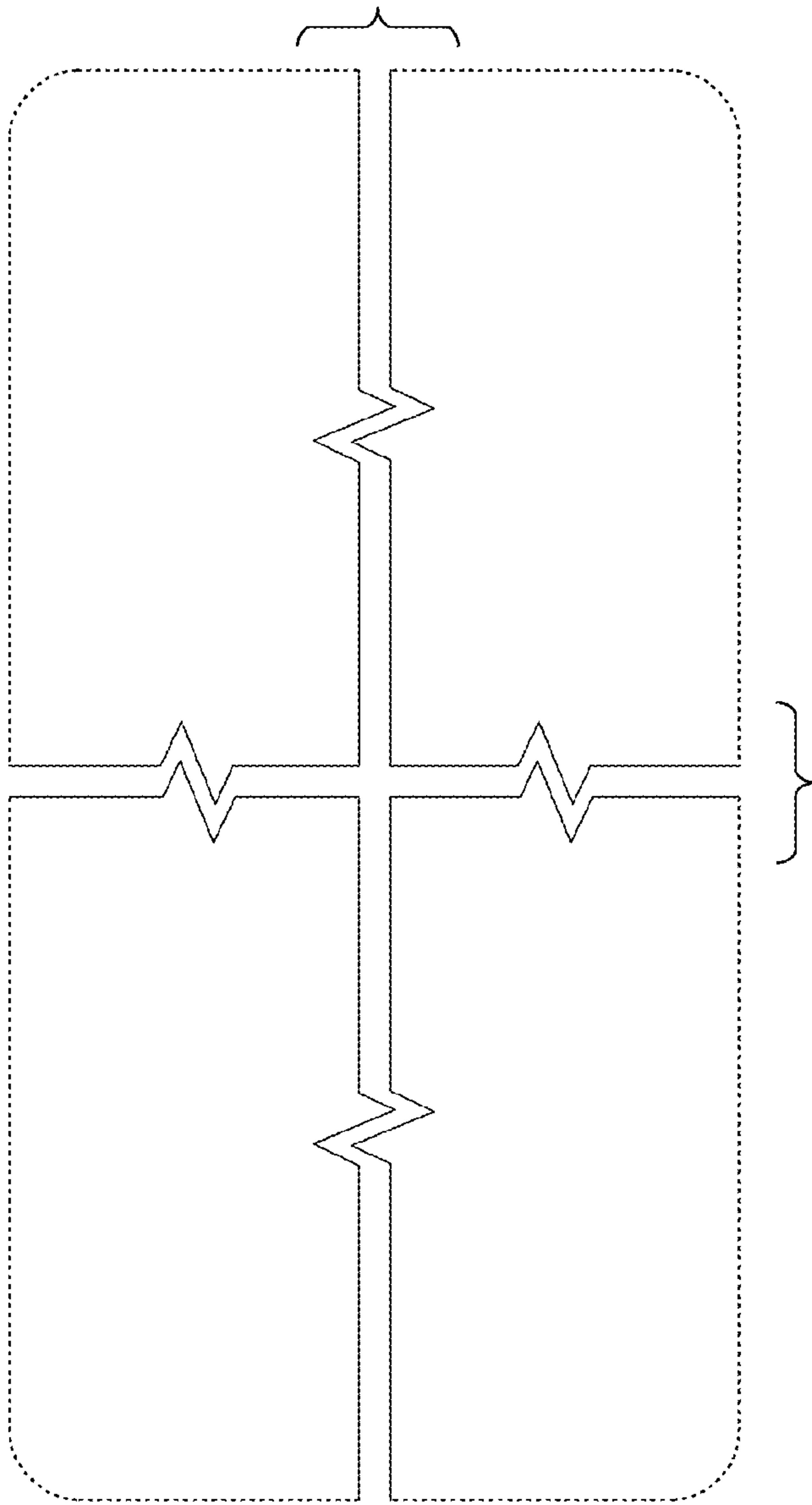

FIG. 3



FIG. 4

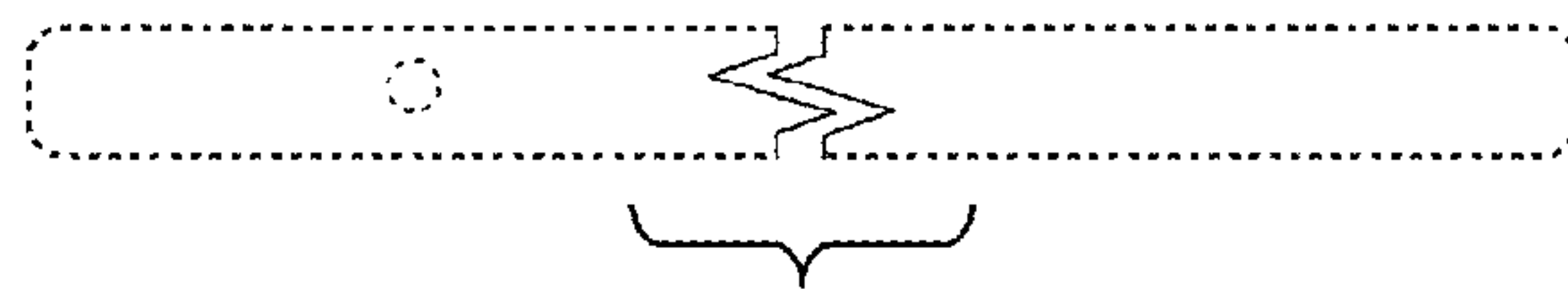

FIG. 5

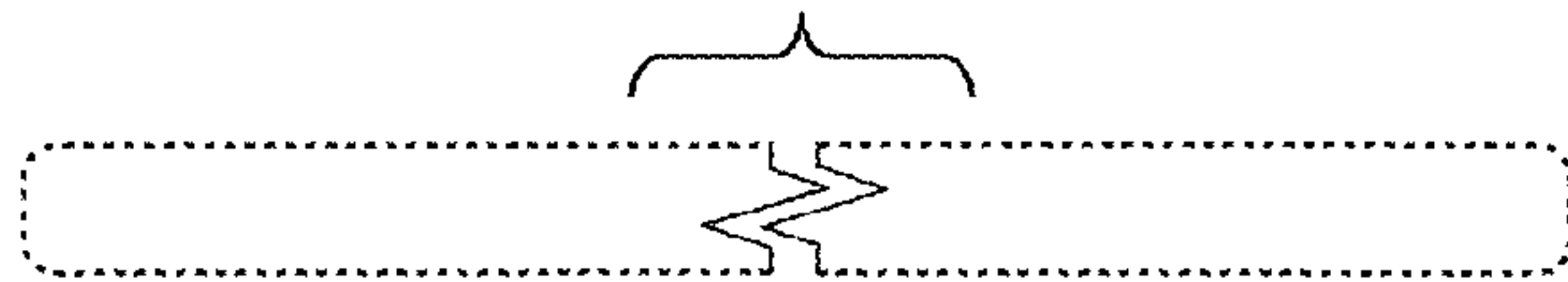

FIG. 6

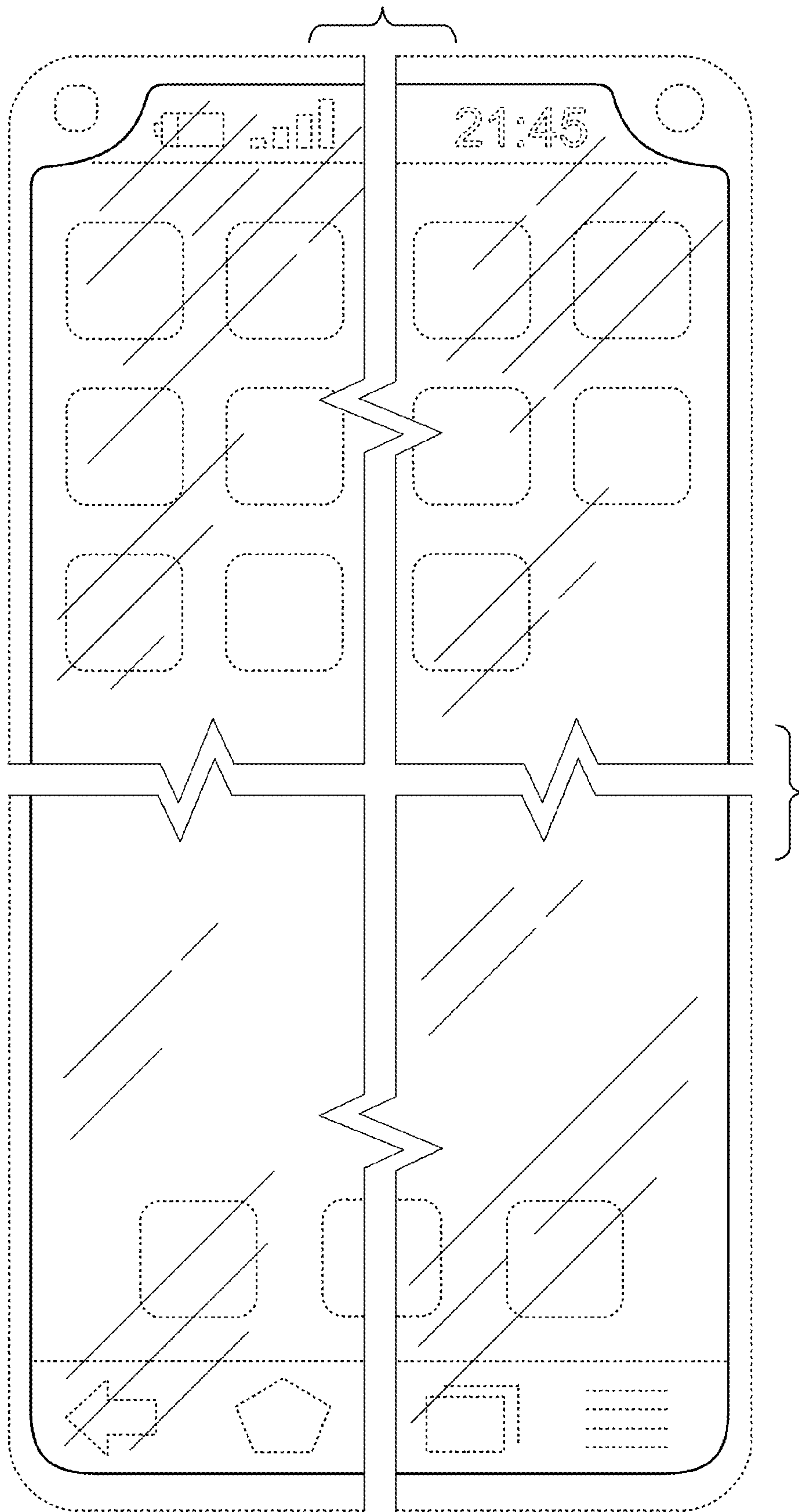

FIG. 7

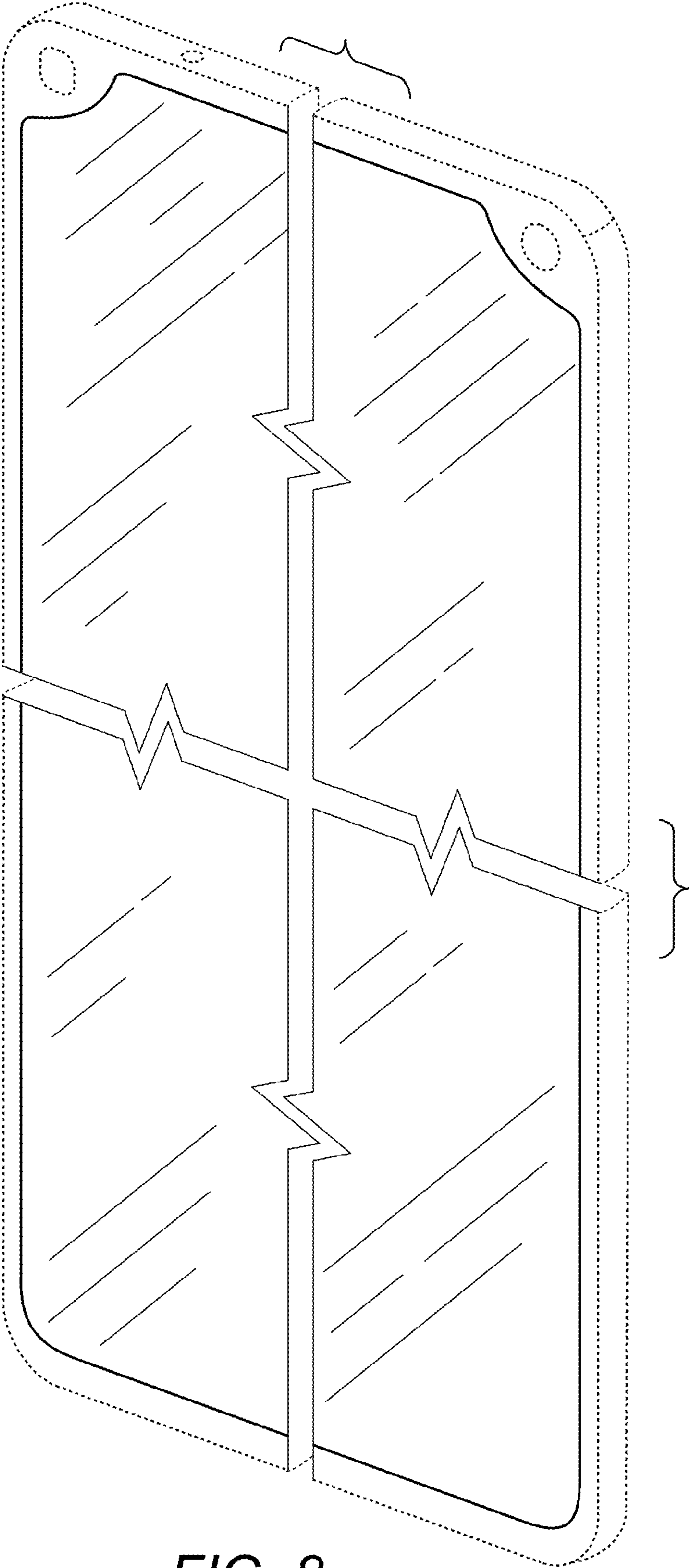

FIG. 8

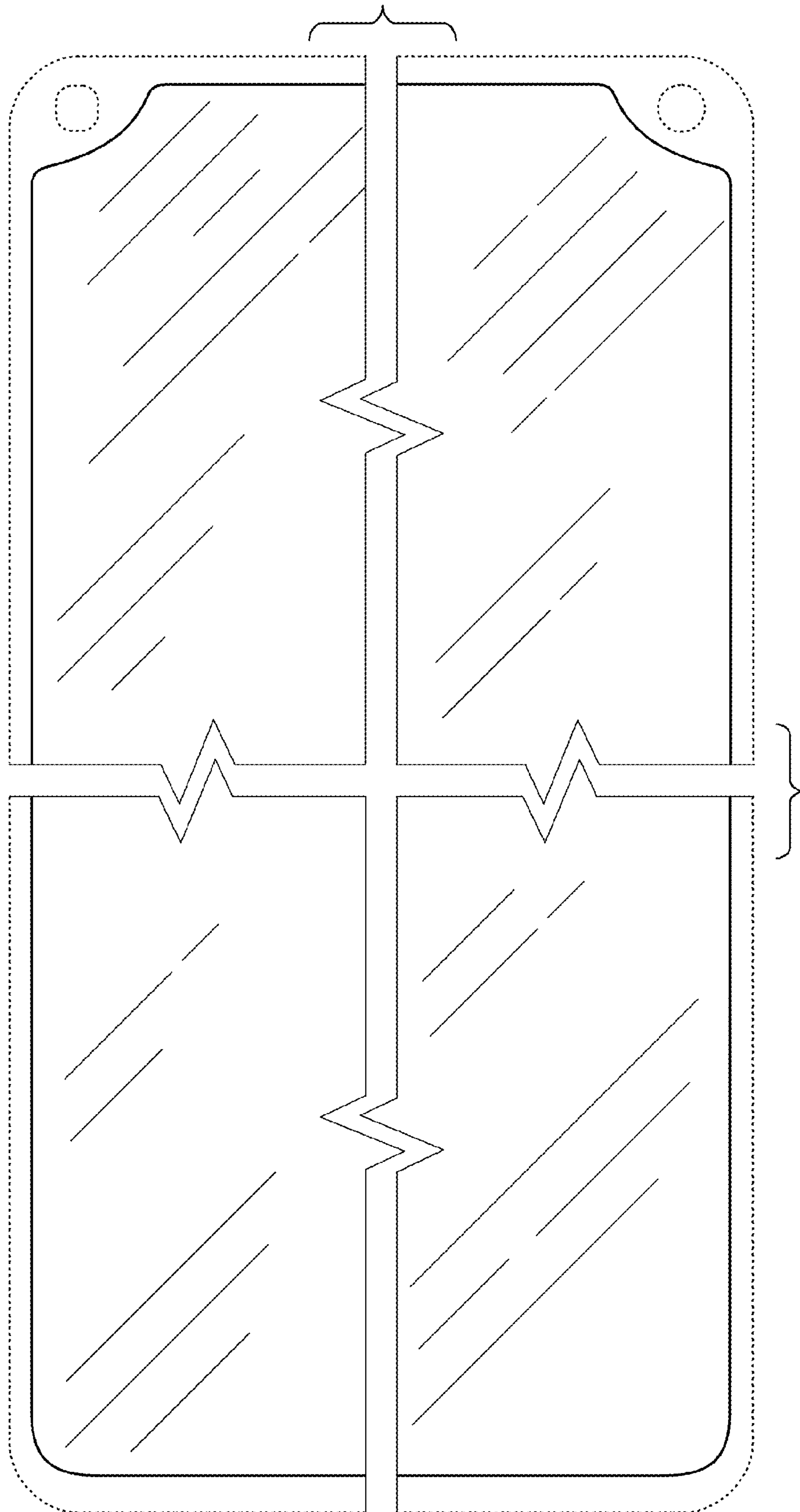

FIG. 9

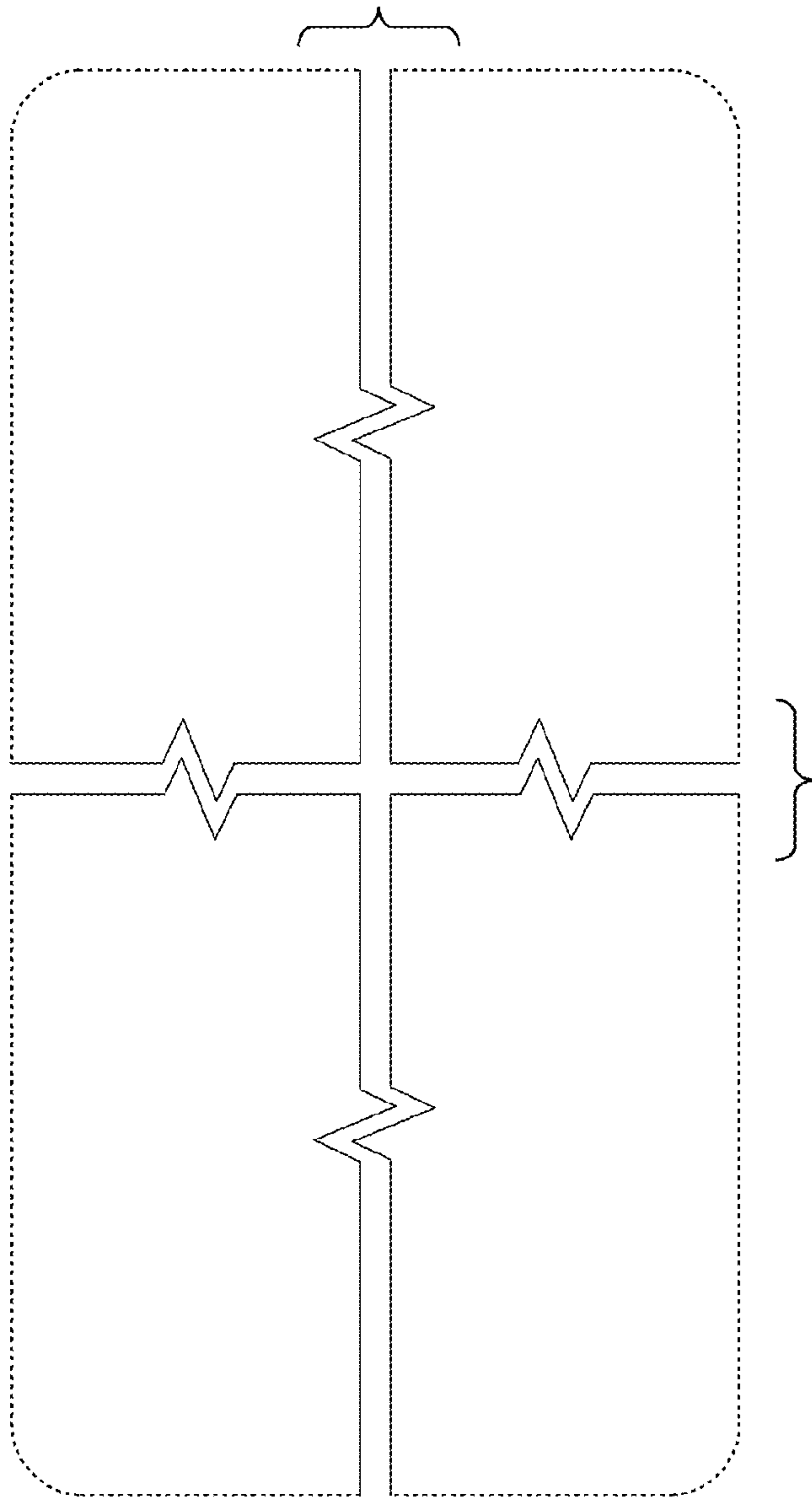

FIG. 10

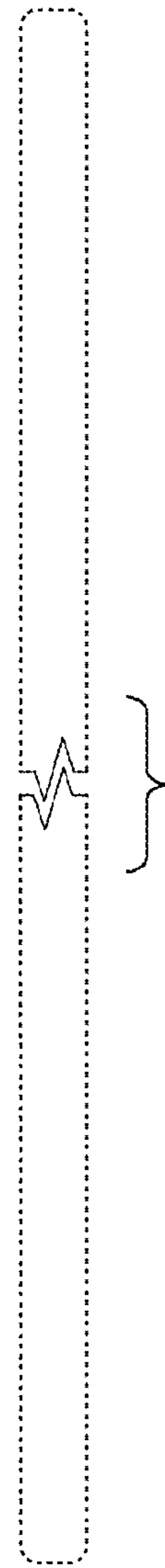

FIG. 11

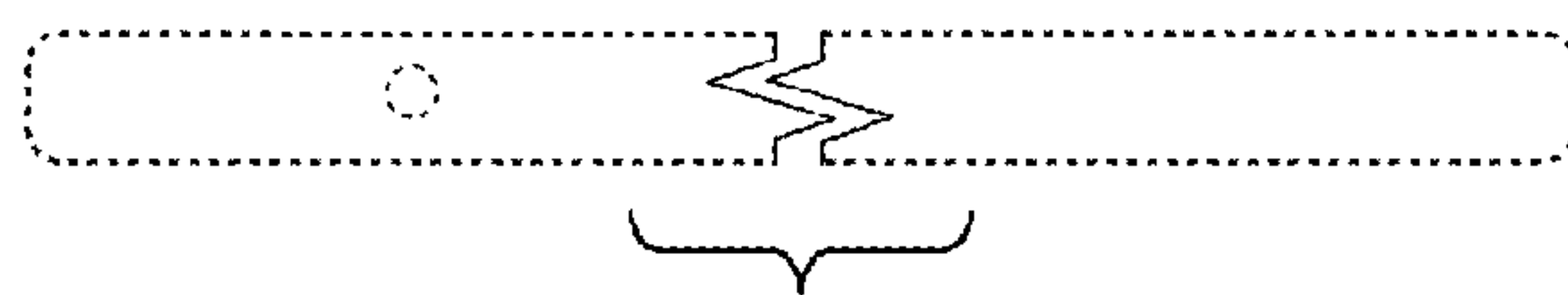

FIG. 12

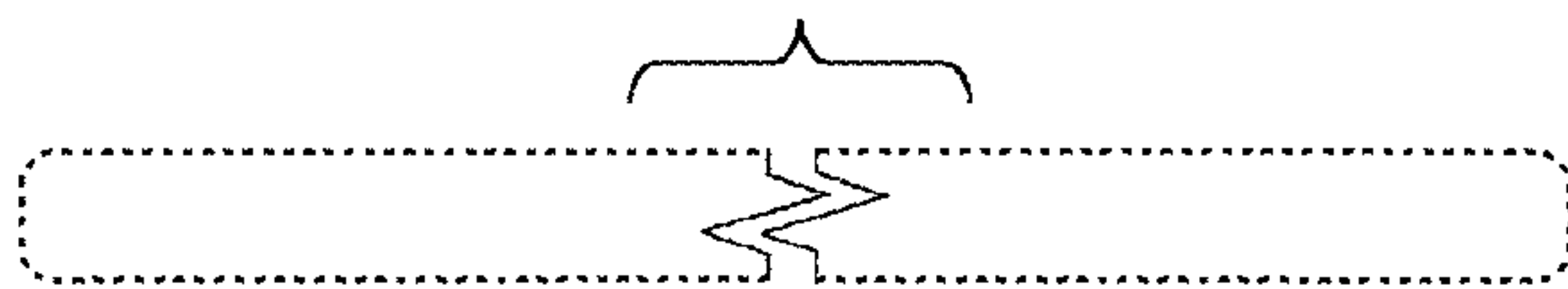

FIG. 13

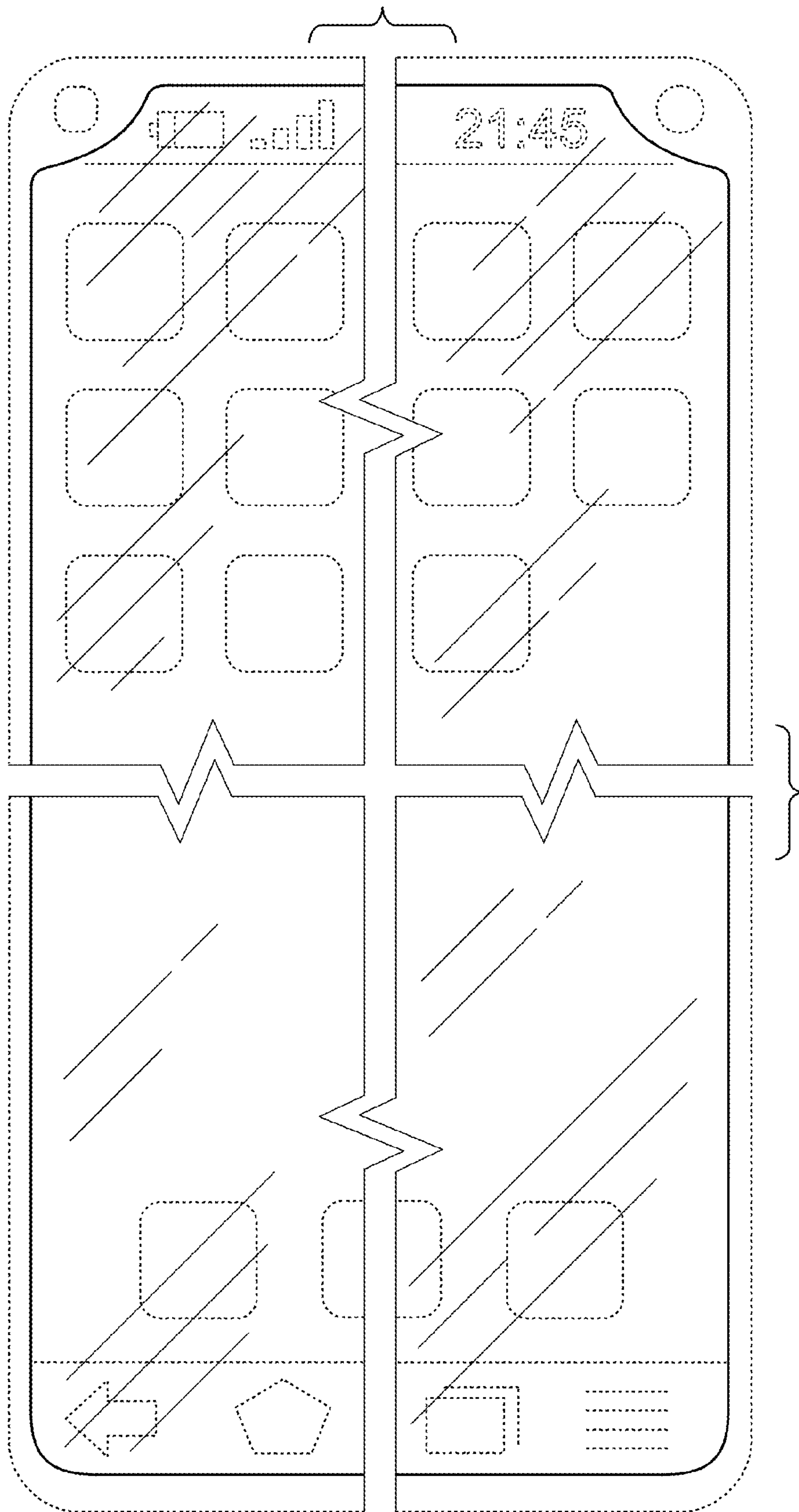

FIG. 14