



US00D911237S

(12) **United States Design Patent**
Feng et al.

(10) **Patent No.:** **US D911,237 S**

(45) **Date of Patent:** **** Feb. 23, 2021**

- (54) **GRILLE ACCENT TOP PANEL**
- (71) Applicant: **PACCAR Inc**, Bellevue, WA (US)
- (72) Inventors: **Rogers Feng**, Issaquah, WA (US);
Elliott Black, Kirkland, WA (US);
Jonathan S. Duncan, Seattle, WA (US)
- (73) Assignee: **PACCAR INC**, Bellevue, WA (US)

D859,233 S *	9/2019	Izard	D12/163
D863,129 S *	10/2019	Zipfel	D12/163
D864,053 S *	10/2019	Zipfel	D12/163
D869,351 S *	12/2019	Duncan	D12/163
D869,352 S *	12/2019	Duncan	D12/163
D873,726 S *	1/2020	Zipfel	D12/163
D885,260 S *	5/2020	Peltola	D12/163
D885,261 S *	5/2020	Zipfel	D12/163

(Continued)

(**) Term: **15 Years**

(21) Appl. No.: **29/678,945**

(22) Filed: **Jan. 31, 2019**

(51) **LOC (13) Cl.** **12-16**

(52) **U.S. Cl.**
USPC **D12/196**

(58) **Field of Classification Search**
USPC D12/86, 90, 91, 92, 163, 169, 171, 181,
D12/184, 196
CPC B62D 33/0617; B62D 53/0821; B60G
2300/07; B60R 13/04; G06F 3/048; H04L
51/04; H04L 51/28
See application file for complete search history.

(56) **References Cited**

U.S. PATENT DOCUMENTS

D647,827 S *	11/2011	Medina	D12/163
D655,226 S *	3/2012	Hanson	D12/163
D673,489 S *	1/2013	Hanson	D12/196
D710,765 S *	8/2014	Conway	D12/163
D738,274 S *	9/2015	Hanson	D12/173
D765,566 S *	9/2016	Vena	D12/163
D772,759 S *	11/2016	Lindloff	D12/114
D774,994 S *	12/2016	Aleman	D12/163
D786,742 S *	5/2017	Ito	D12/163
D802,491 S *	11/2017	Mainville	D12/163
D803,731 S *	11/2017	Zipfel	D12/163
D825,407 S *	8/2018	Heyde	D12/163
D830,242 S *	10/2018	Zipfel	D12/163
D835,011 S *	12/2018	Peltola	D12/163
D845,184 S *	4/2019	Zipfel	D12/163

OTHER PUBLICATIONS

Belmor Aeroshield Stainless Steel Bug Shield. 4 state trucks.com. No date. https://www.4statetrucks.com/hoods-body-parts/semi-truck-belmor-aeroshield-stainless-steel-bug-shield-fits-kenworth-t800_198019.asp?gclid=EAlaQobChM12Yi7163V6gIVAYbICh1-DQE1EAQYAyABEgL7GPD_BwE.*

(Continued)

Primary Examiner — Janice Hallmark

Assistant Examiner — Suzanne E Tisdell

(74) *Attorney, Agent, or Firm* — Seed IP Law Group LLP

(57) **CLAIM**

The ornamental design for a grille accent top panel, as shown and described.

DESCRIPTION

FIG. 1 is a perspective view of a grille accent top panel showing our new design in the environment of a vehicle; FIG. 2 is a front perspective view of the grille accent top panel shown in FIG. 1; FIG. 3 is a front view thereof; FIG. 4 is a top view thereof; FIG. 5 is a right side view thereof; and, FIG. 6 is a left side view thereof. The broken lines shown in FIG. 1 illustrate environmental subject matter that forms no part of the claimed design. The broken lines in FIGS. 2-6 illustrate portions of the grille accent top panel that form no part of the claimed design.

1 Claim, 3 Drawing Sheets

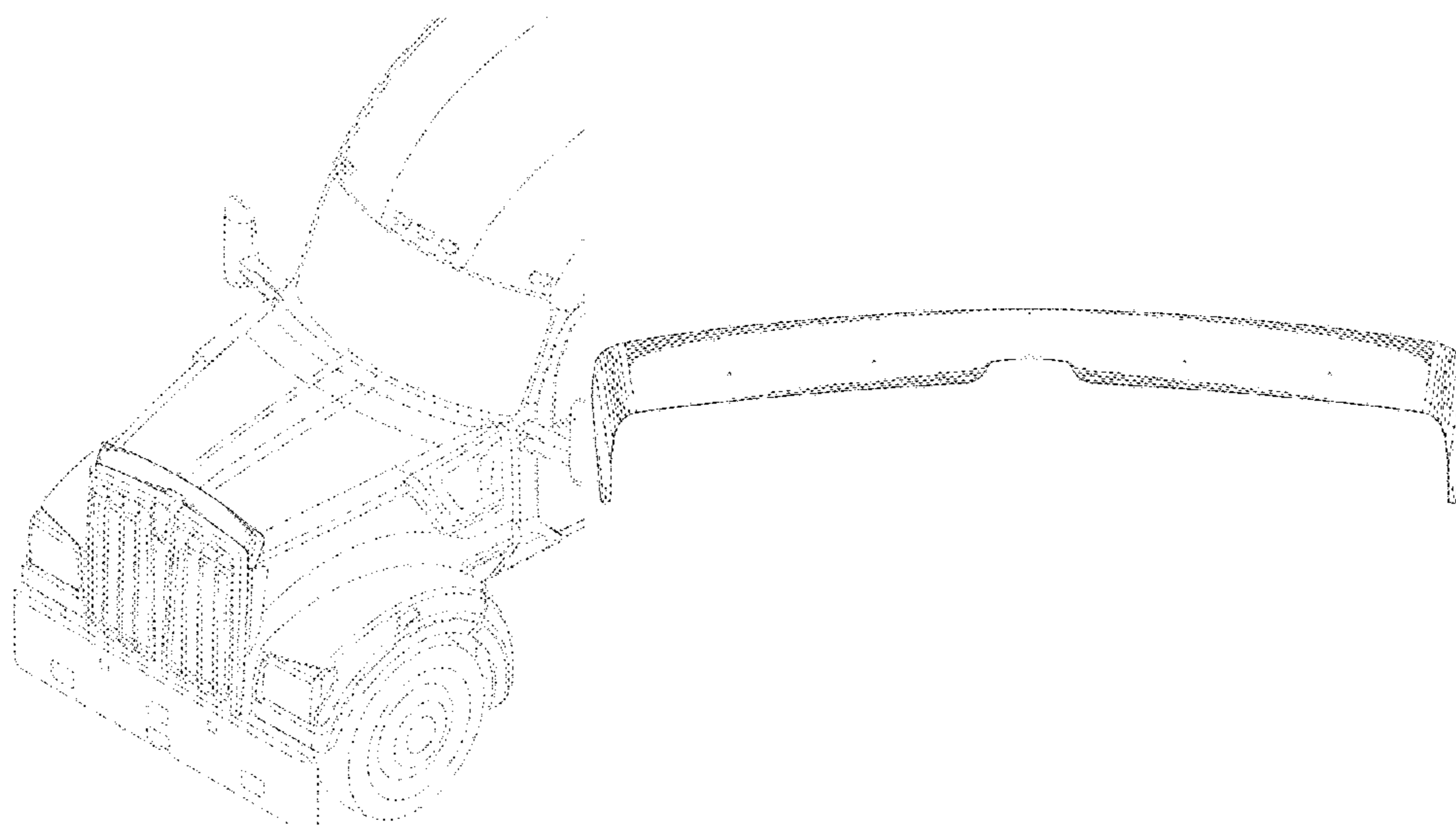

(56)

References Cited

U.S. PATENT DOCUMENTS

D885,264 S * 5/2020 Lenz, Jr. D12/164
2009/0085361 A1 * 4/2009 Rosen B60R 13/04
293/120

OTHER PUBLICATIONS

Freightliner M2 Bug Shield. Ebay. No date. <https://www.ebay.com/itm/For-Freightliner-M2-106-2010-2016-TRUX-Bug-Shield-/303097084452>.*

* cited by examiner

Fig. 1.

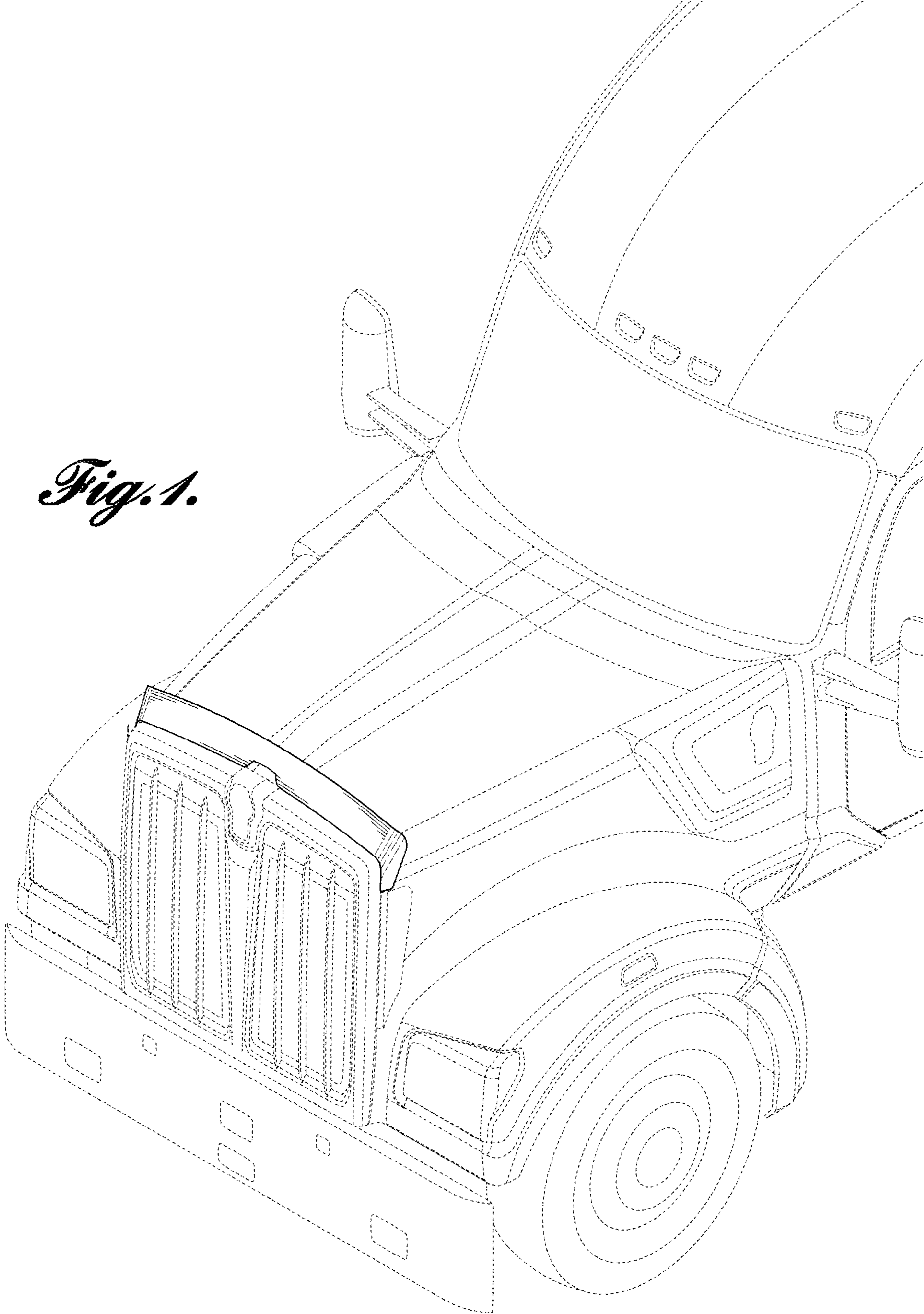

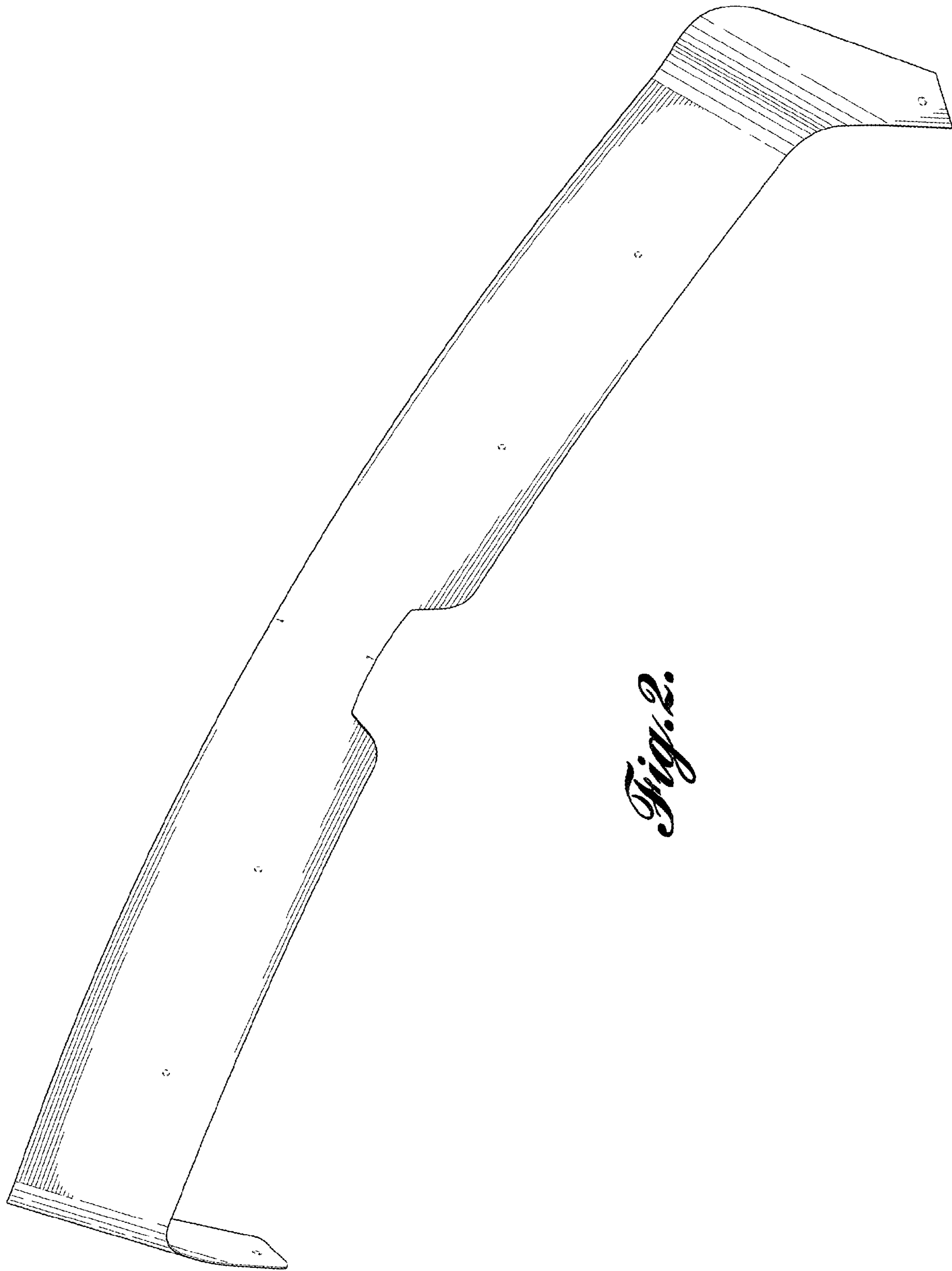

Fig. 2.

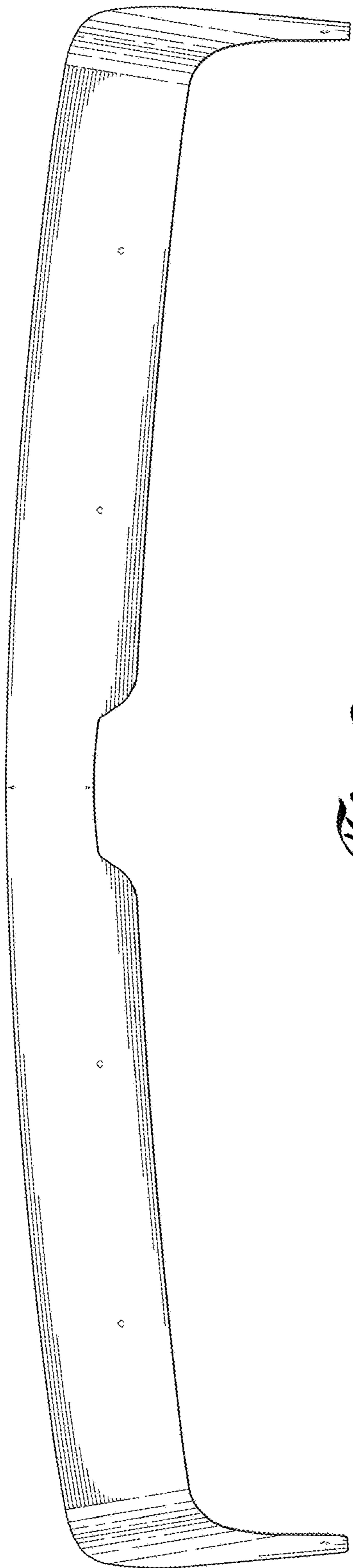

Fig. 3.

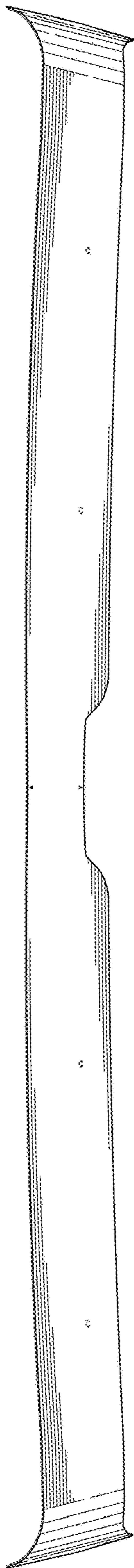

Fig. 4.

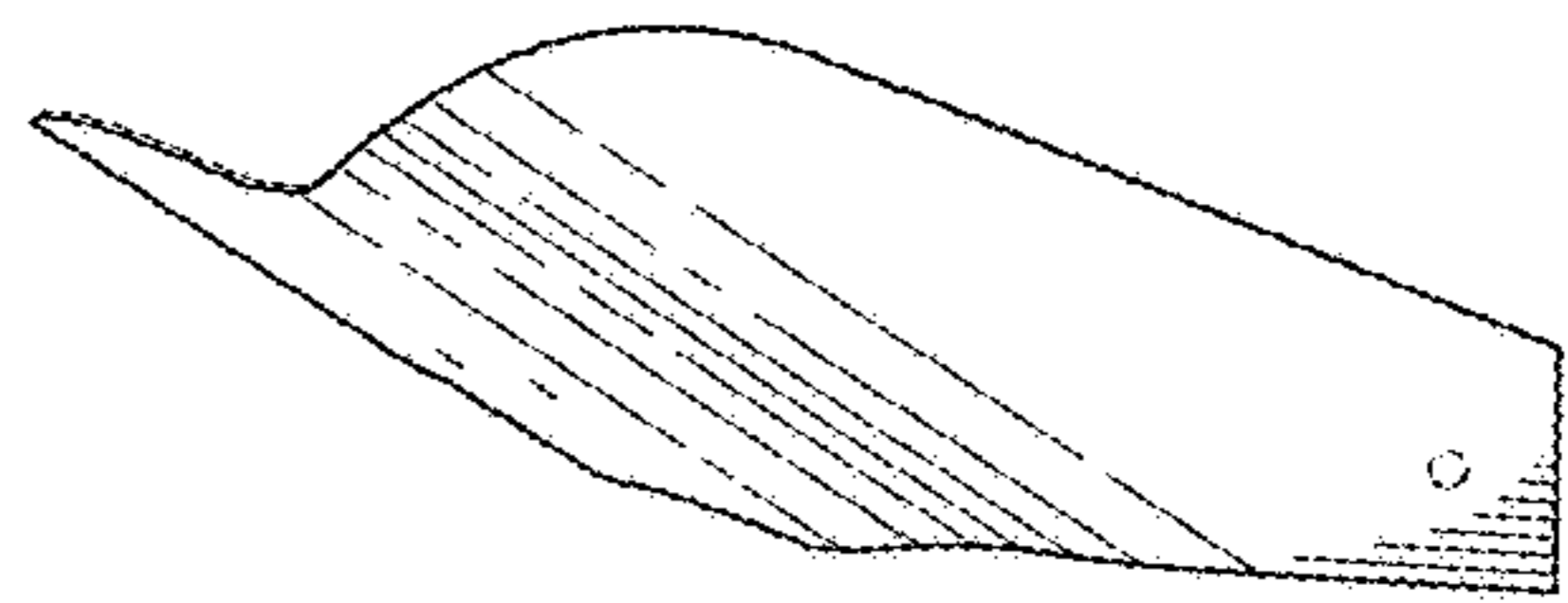

Fig. 6.

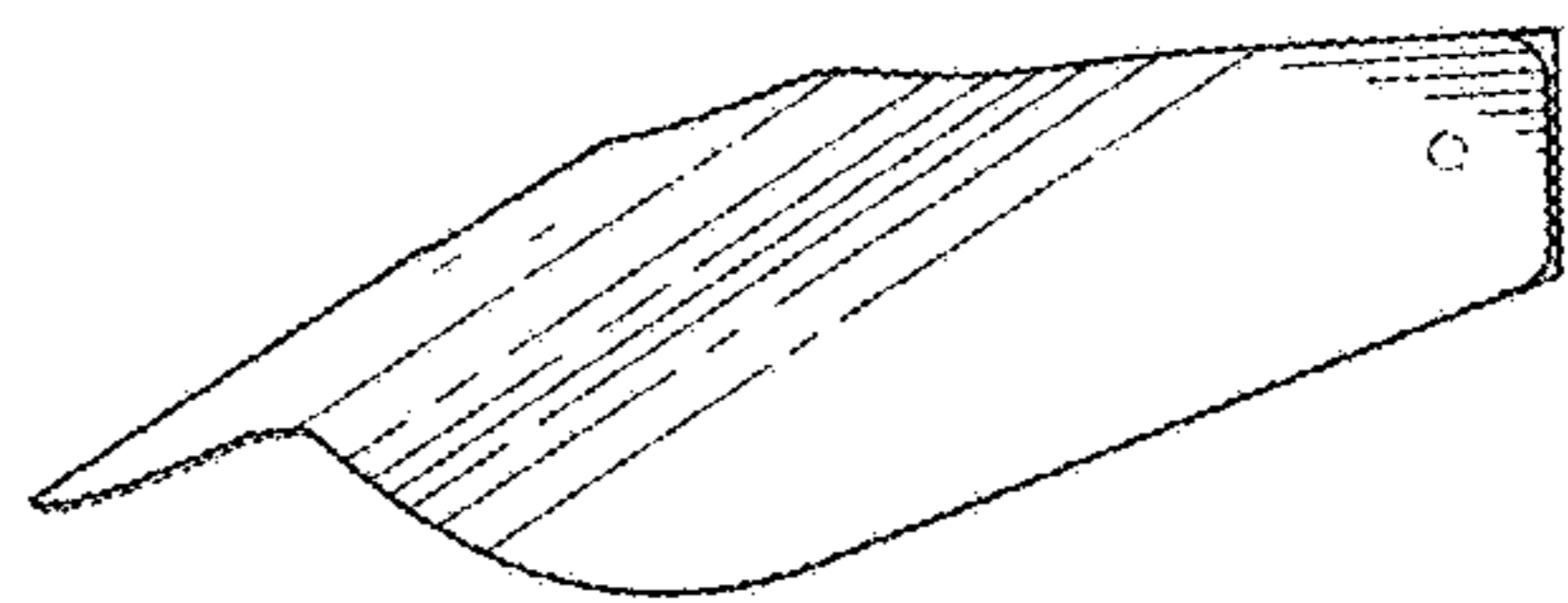

Fig. 5.