



US00D911221S

(12) **United States Design Patent** (10) **Patent No.:** **US D911,221 S**
Pishevar et al. (45) **Date of Patent:** **** Feb. 23, 2021**

(54) **AUTOMOBILE BODY**
(71) Applicant: **Bolt Mobility Corporation**, Miami Beach, FL (US)
(72) Inventors: **Shervin Pishevar**, Miami, FL (US); **Eduard Gray**, Vargön (SE)
(73) Assignee: **Bolt Mobility Corporation**, Miami Beach, FL (US)
(**) Term: **15 Years**
(21) Appl. No.: **29/691,385**
(22) Filed: **May 15, 2019**
(51) **LOC (13) Cl.** **12-08**
(52) **U.S. Cl.**
USPC **D12/90**
(58) **Field of Classification Search**
USPC D12/86, 90-92, 88, 164; D21/424, 433, D21/434; 296/181.1-181.5, 183.1
CPC B62D 25/00; B62D 25/06; B62D 33/00; B62D 35/00
See application file for complete search history.

D610,039 S * 2/2010 Koide D12/90
D676,359 S * 2/2013 Panoz D12/86
D678,819 S * 3/2013 Akamine D12/90
D684,091 S * 6/2013 Frenzel D12/90
D738,258 S * 9/2015 Perlo D12/91
D749,464 S * 2/2016 Giolito D12/91
D768,541 S * 10/2016 Burki D12/90
D834,999 S * 12/2018 Ma D12/90

* cited by examiner

Primary Examiner — Melody N Brown

(74) *Attorney, Agent, or Firm* — Perkins Coie LLP

(57) **CLAIM**

The ornamental design for an automobile body, as shown and described.

DESCRIPTION

FIG. 1 is a side elevational view of an automobile body showing our new design;
FIG. 2 is an opposite side elevational view thereof;
FIG. 3 is a front view thereof.
FIG. 4 is a rear view thereof.
FIG. 5 is a top plan view thereof.
FIG. 6 is a bottom view thereof; and,
FIG. 7 is a front and side perspective view thereof.
The details shown in broken lines in the accompanying drawings are for illustrative purposes only and form no part of the claimed design.

(56) **References Cited**

U.S. PATENT DOCUMENTS

D350,503 S * 9/1994 Yang D12/90
D373,330 S * 9/1996 Halajko D12/90

1 Claim, 7 Drawing Sheets

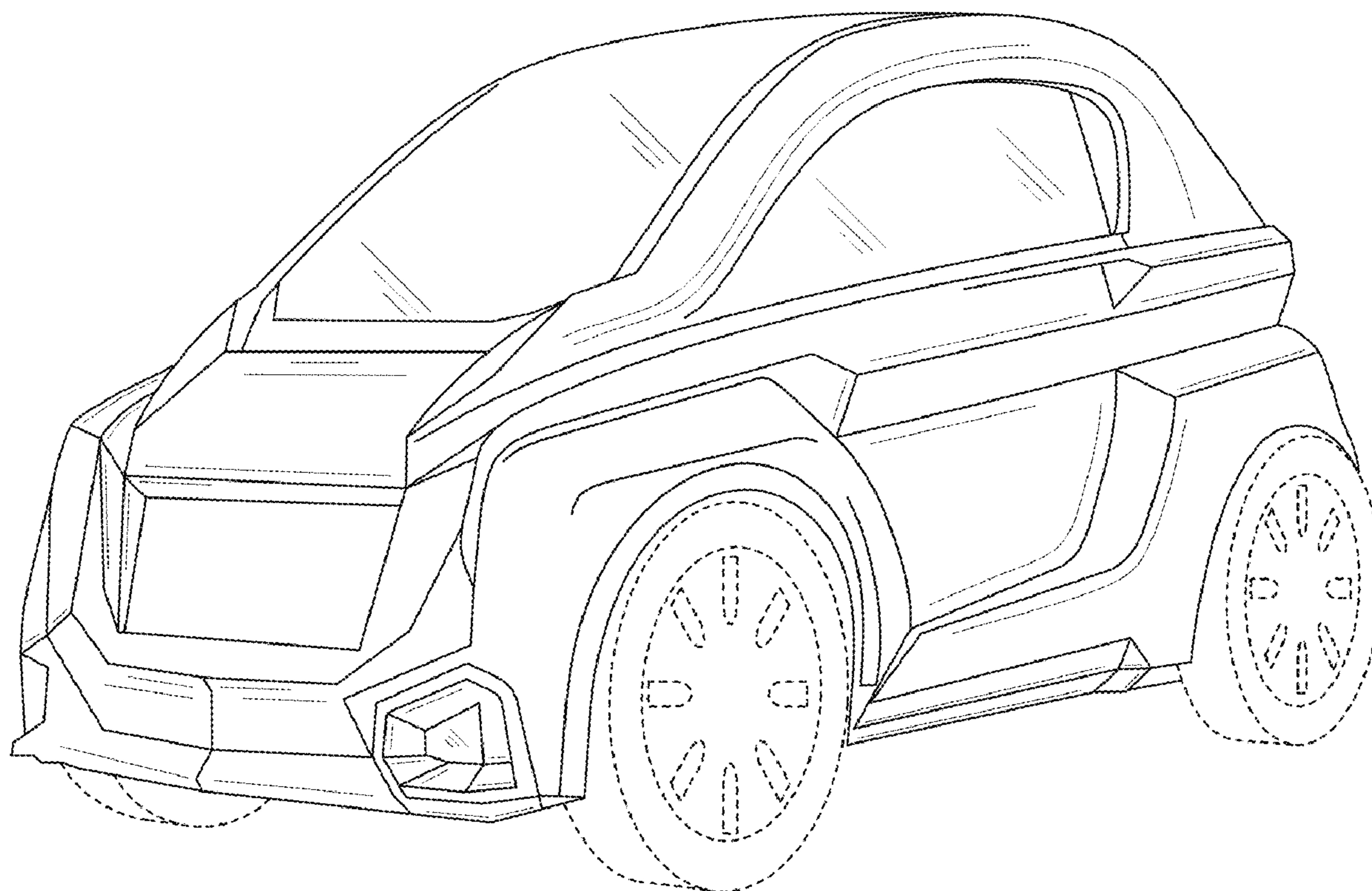

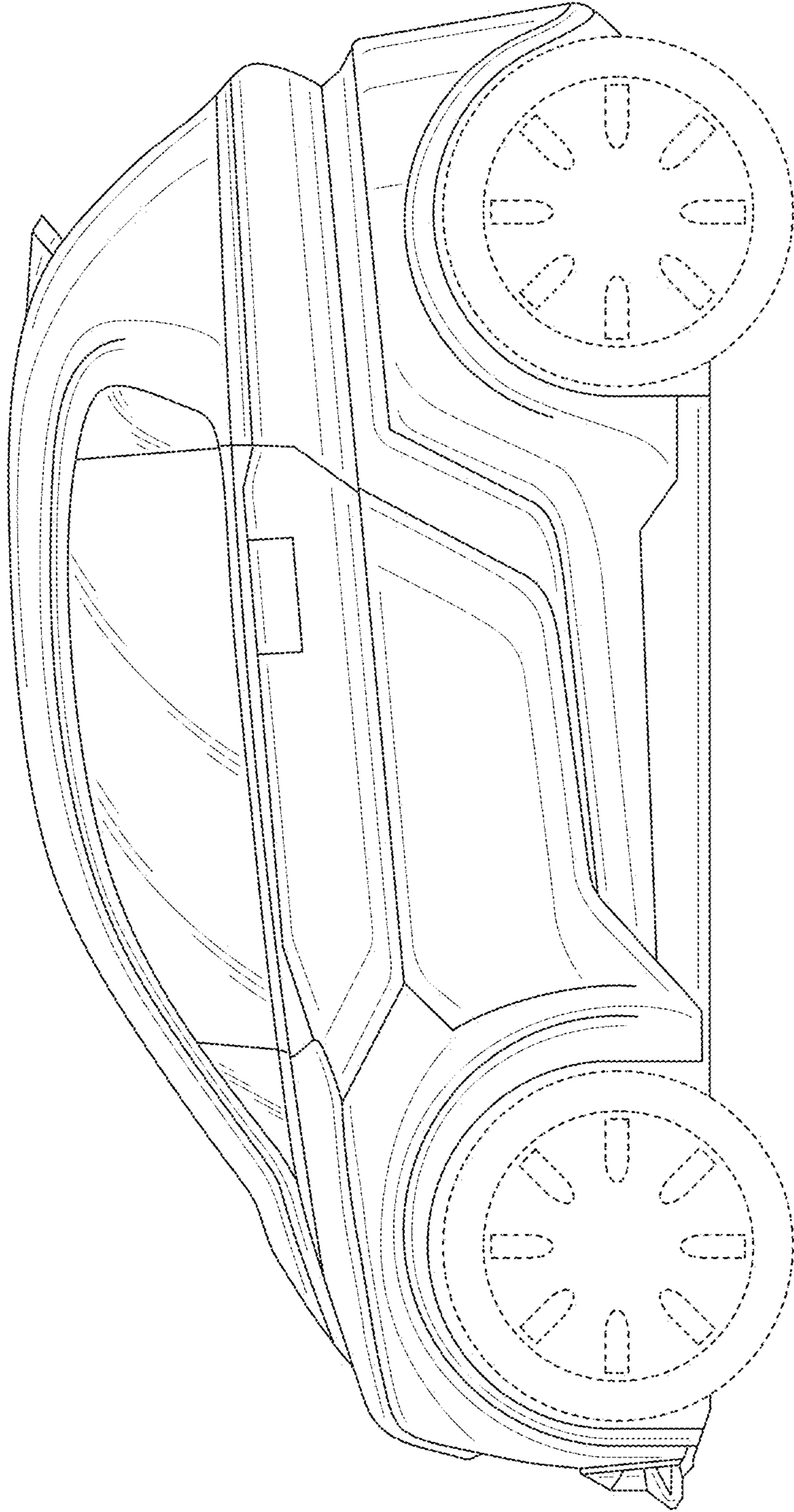

Fig. 1

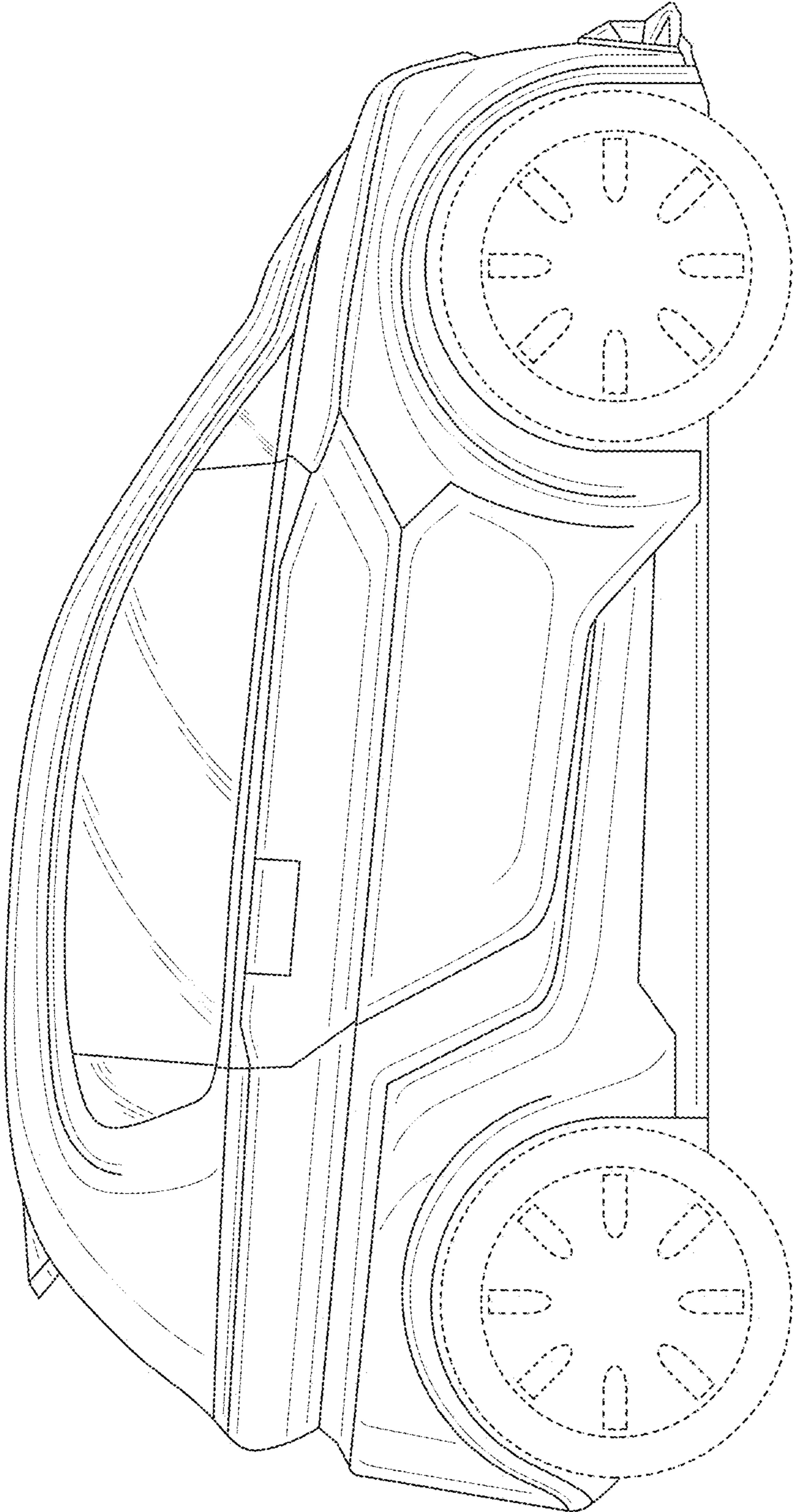

Fig. 2

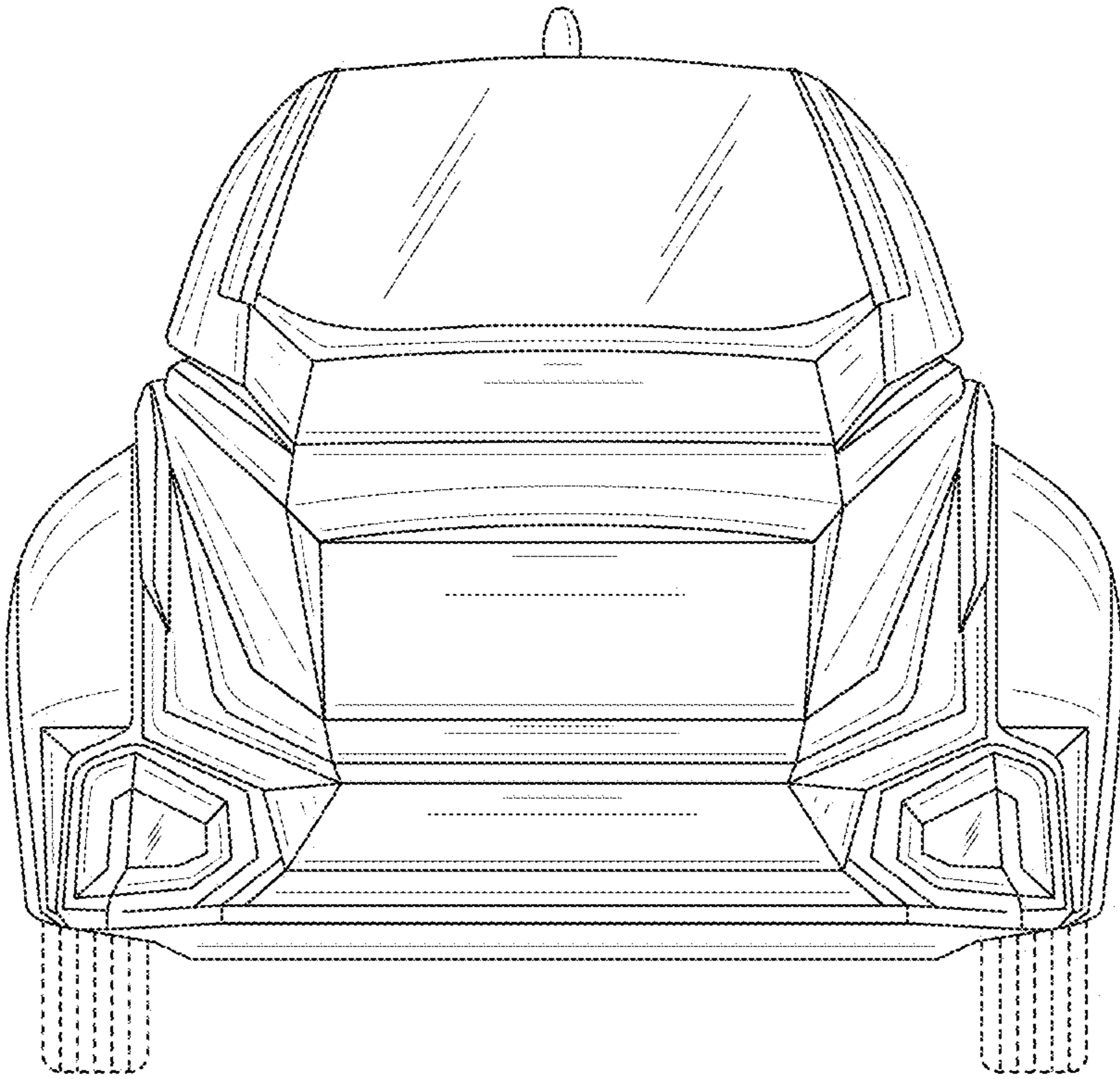

Fig. 3

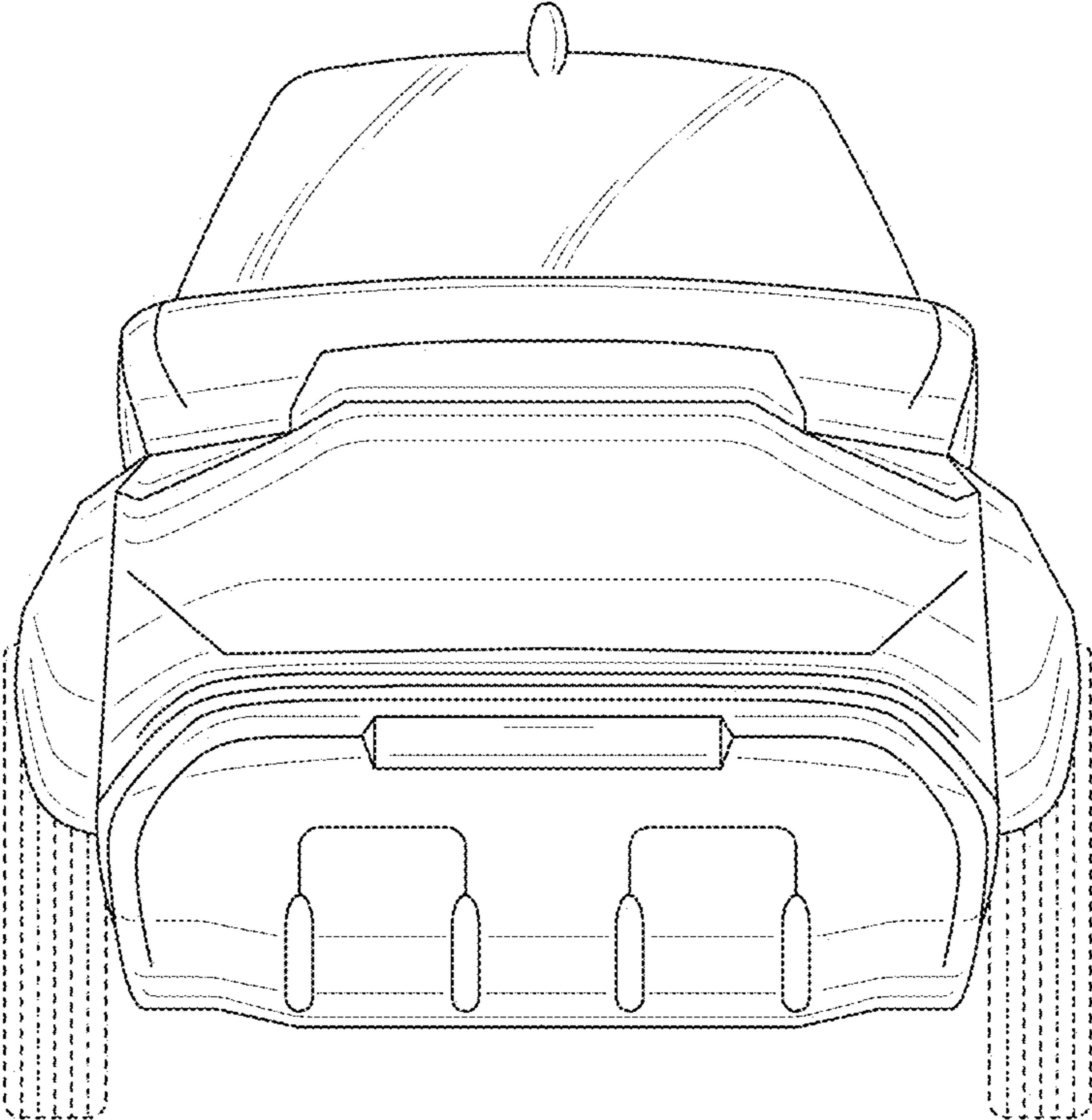

Fig. 4

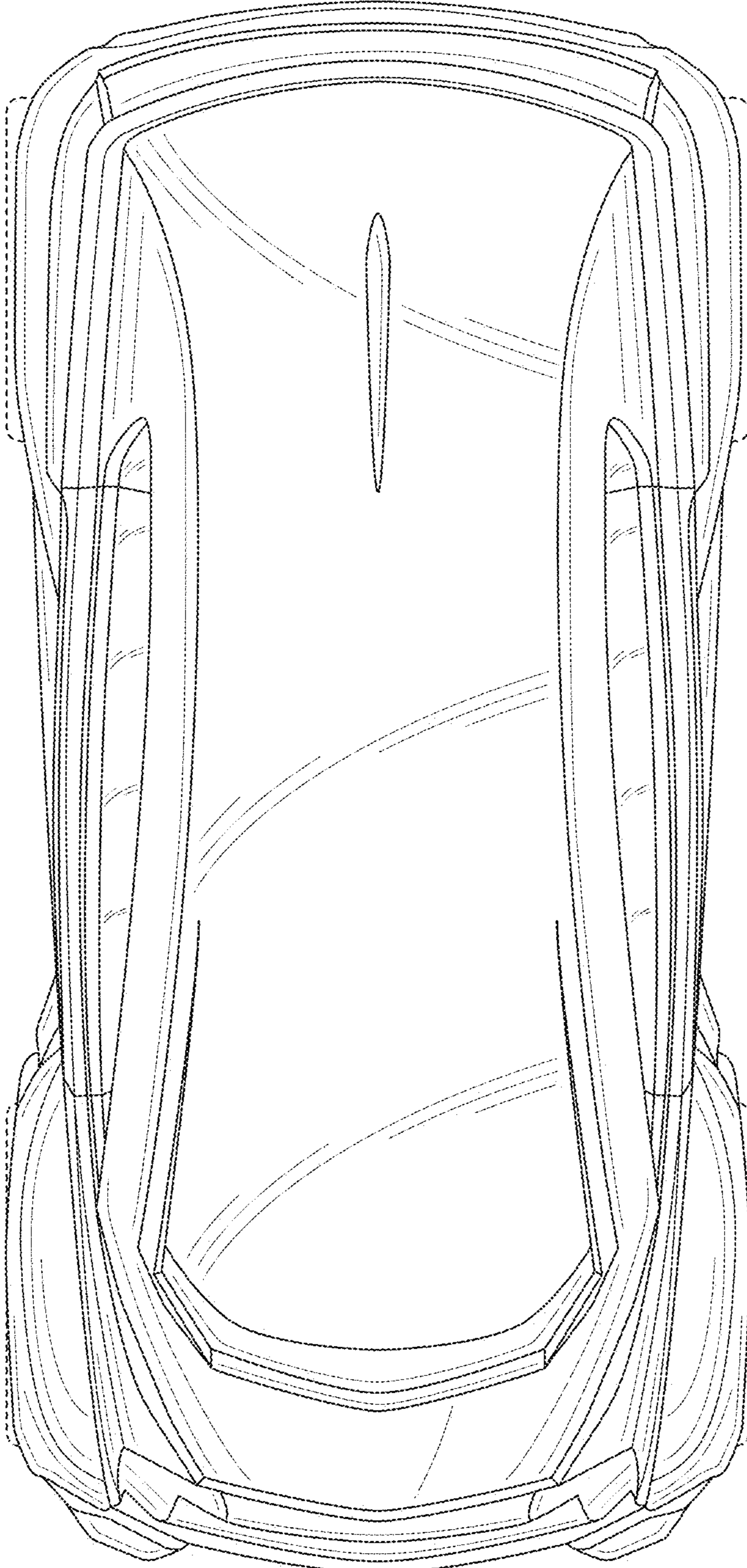

Fig. 5

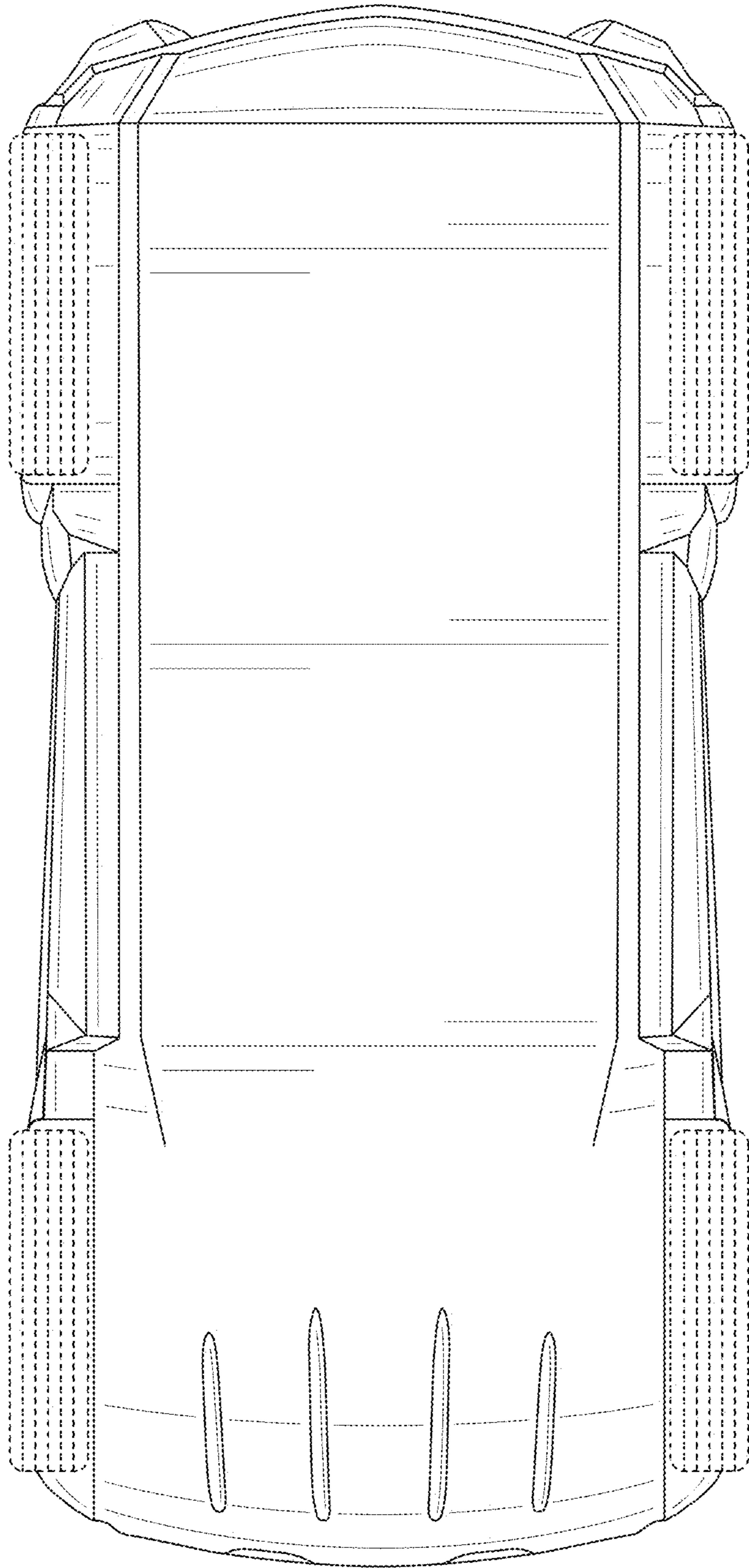

Fig. 6

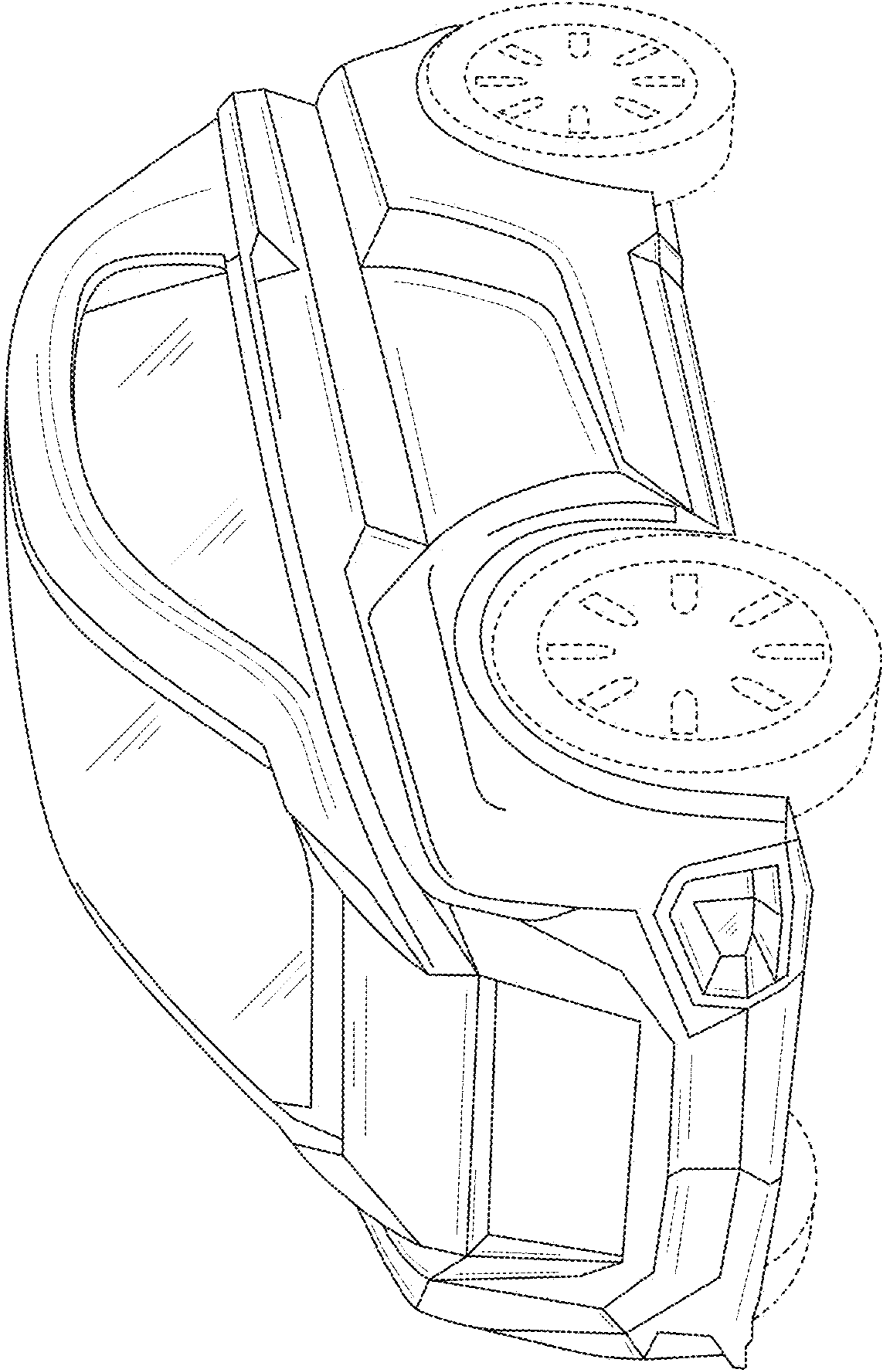

Fig. 7