



US00D911067S

(12) **United States Design Patent** (10) **Patent No.:** **US D911,067 S**
Little (45) **Date of Patent:** **** Feb. 23, 2021**

(54) **PILLOW**
(71) Applicant: **DG International Holdings Limited**,
London (GB)
(72) Inventor: **Simon Little**, Middlesex (GB)
(73) Assignee: **DG International Holdings Limited**,
London (GB)
(**) Term: **15 Years**
(21) Appl. No.: **29/662,488**
(22) Filed: **Sep. 6, 2018**
(51) **LOC (13) Cl.** **06-09**
(52) **U.S. Cl.**
USPC **D6/601**
(58) **Field of Classification Search**
USPC D6/601, 382, 383; D24/191
CPC A47C 7/383; A47C 16/005; A47C 20/00;
A47C 20/02; A47C 20/027; A47C 20/04;
A47G 2009/1018; A47G 9/10; A47G
9/1027; A47G 9/1081; A47G 9/0253;
A47G 9/1045; A47G 9/1072; A61G
7/072; A61G 13/121; A61G 7/07; A61G
13/1225
See application file for complete search history.

(56) **References Cited**
U.S. PATENT DOCUMENTS
D124,296 S * 12/1940 Thompson D6/601
D318,969 S * 8/1991 Byrn D6/601
D348,174 S * 6/1994 Genis D24/191
D445,624 S * 7/2001 Futagami 5/644
D522,300 S * 6/2006 Roberts A47C 7/383
D6/601
D550,495 S * 9/2007 Boutin D6/601
D583,605 S * 12/2008 Krinsky D6/601
D590,198 S * 4/2009 Nostrant D6/601
D604,438 S * 11/2009 Thomson D26/51
D685,212 S * 7/2013 Rivera D6/601

8,595,872 B2 * 12/2013 Tidwell A47D 13/08
5/490
D699,982 S * 2/2014 Fair A47D 13/083
D6/601
D704,963 S * 5/2014 McNeil D6/601
9,370,269 B2 * 6/2016 Edwards A47C 7/383
D769,648 S * 10/2016 Atkinson D6/601
D782,220 S * 3/2017 Little D6/601
D796,869 S * 9/2017 Higashi D6/601
D808,196 S * 1/2018 Schumacher D6/601
D817,031 S * 5/2018 Denat D6/601
10,076,190 B2 * 9/2018 Atkinson A47C 7/383
D838,123 S * 1/2019 Ye D6/601
(Continued)

OTHER PUBLICATIONS

Adjustable Inflatable Neck Pillow (on-line), dated Oct. 8, 2016.
Retrieved from Internet Oct. 31, 2019, URL: <https://web.archive.org/web/20161008051141/https://lewisnclark.com/adjustable-neck-pillow/> (5 pages) (Year: 2016).*
(Continued)

Primary Examiner — Kimberly Barnes
(74) *Attorney, Agent, or Firm* — Budzyn IP Law, LLC

(57) **CLAIM**
The ornamental design for a pillow, as shown and described.

DESCRIPTION

FIG. 1 is a perspective view of a pillow showing my new design;
FIG. 2 is a top plan view thereof;
FIG. 3 is a bottom plan view thereof;
FIG. 4 is a front elevational view thereof;
FIG. 5 is a rear elevational view thereof;
FIG. 6 is a left side elevational view thereof; and,
FIG. 7 is a right side elevational view thereof.
The broken lines represent elements which form no part of the claimed design.

1 Claim, 7 Drawing Sheets

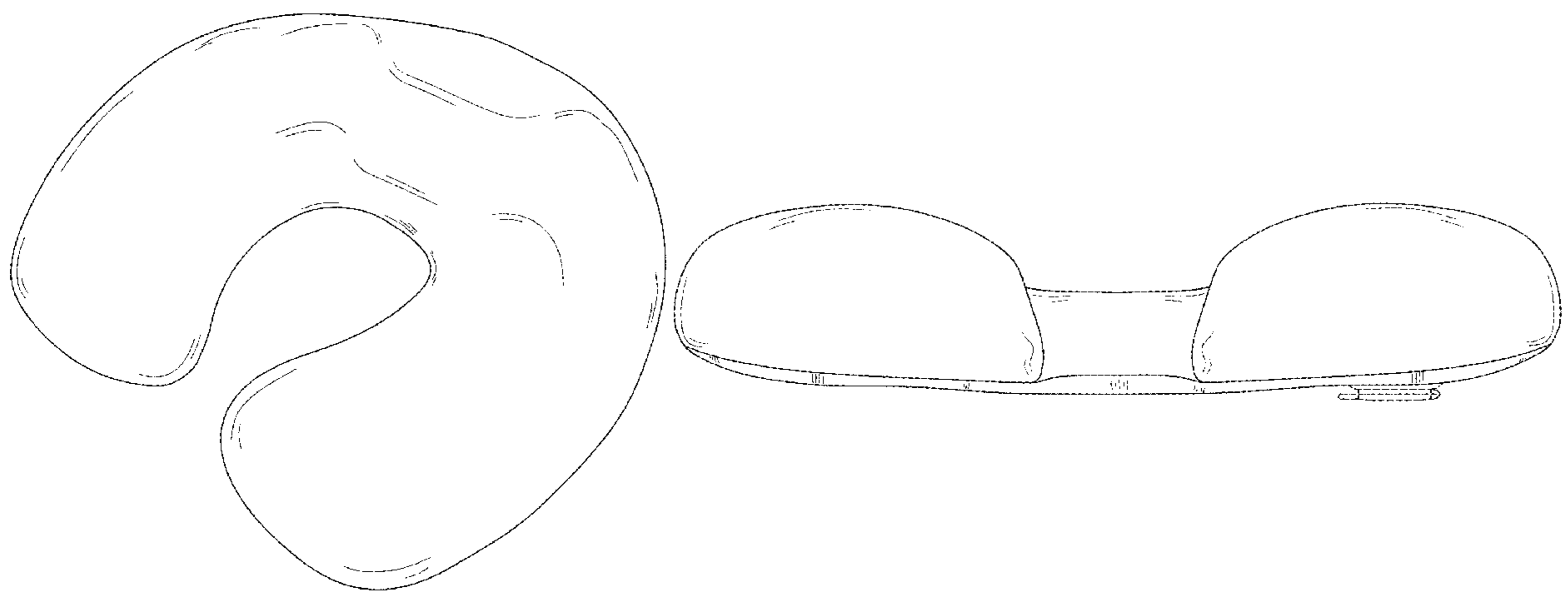

(56)

References Cited

U.S. PATENT DOCUMENTS

| | | | | | |
|--------------|------|--------|----------|-------|-------------|
| D846,913 | S * | 4/2019 | Liu | | D6/601 |
| D872,503 | S * | 1/2020 | Little | | D6/601 |
| D873,052 | S * | 1/2020 | Blanc | | D6/601 |
| D878,808 | S * | 3/2020 | Denat | | D6/601 |
| 2006/0031992 | A1 * | 2/2006 | Moore | | A47C 20/021 |
| | | | | | 5/630 |
| 2015/0257554 | A1 * | 9/2015 | Ross | | A47C 27/086 |
| | | | | | 5/639 |
| 2016/0029821 | A1 * | 2/2016 | Atkinson | | A47G 9/10 |
| | | | | | 5/636 |
| 2017/0042352 | A1 * | 2/2017 | Atkinson | | A47G 9/1081 |
| 2018/0125271 | A1 * | 5/2018 | Blanc | | A47G 9/0253 |
| 2019/0223602 | A1 * | 7/2019 | Radke | | A47C 7/383 |

OTHER PUBLICATIONS

Go Travel Supreme Snoozer Inflatable Neck Pillow (on-line), no date available. Retrieved from Internet Oct. 31, 2019, URL: www.luggageworldmn.com/go-travel-supreme-snoozer-inflatable-neck-pillow.html (1 page).*

Inflatable Travel Pillow with Fleece Cover (on-line), no date available. Retrieved from Internet Oct. 31, 2019, URL: https://www.brilliantpromos.com/ap/Inflatable-Travel-Pillow-with-Fleece-Cover-552141396?gclid=EAlalQobChMI2eiFxsZ5QIViJ6fCh0jrAuUEAQYBSABEGlyqvD_BwE (1 page).*

Quality Travel Pillow Neck Rest (on-line), Mar. 5, 2019. Retrieved from Internet Oct. 31, 2019, URL: web.archive.org/web/20190305204132/https://www.travellwell.com/collections/travel-accessories/products/quality-travel-pillow-neck-rest-black-inflatable-airplane-neck-pillow-comfortable-pillows-to-sleep-well-travel (6 pgs).*

U Shaped Travel Pillow Air Flight Inflatable Neck Support Headrest Cushion (on-line), no date available. Retrieved from Internet Oct. 31, 2019, URL: <https://www.lelong.com.my/u-shaped-travel-pillow-air-flight-inflatable-neck-support-headrest-cushion-ro-ebazaar101-F1698112-2007-01-Sale-1.htm> (6 pages).*

* cited by examiner



FIG. 1

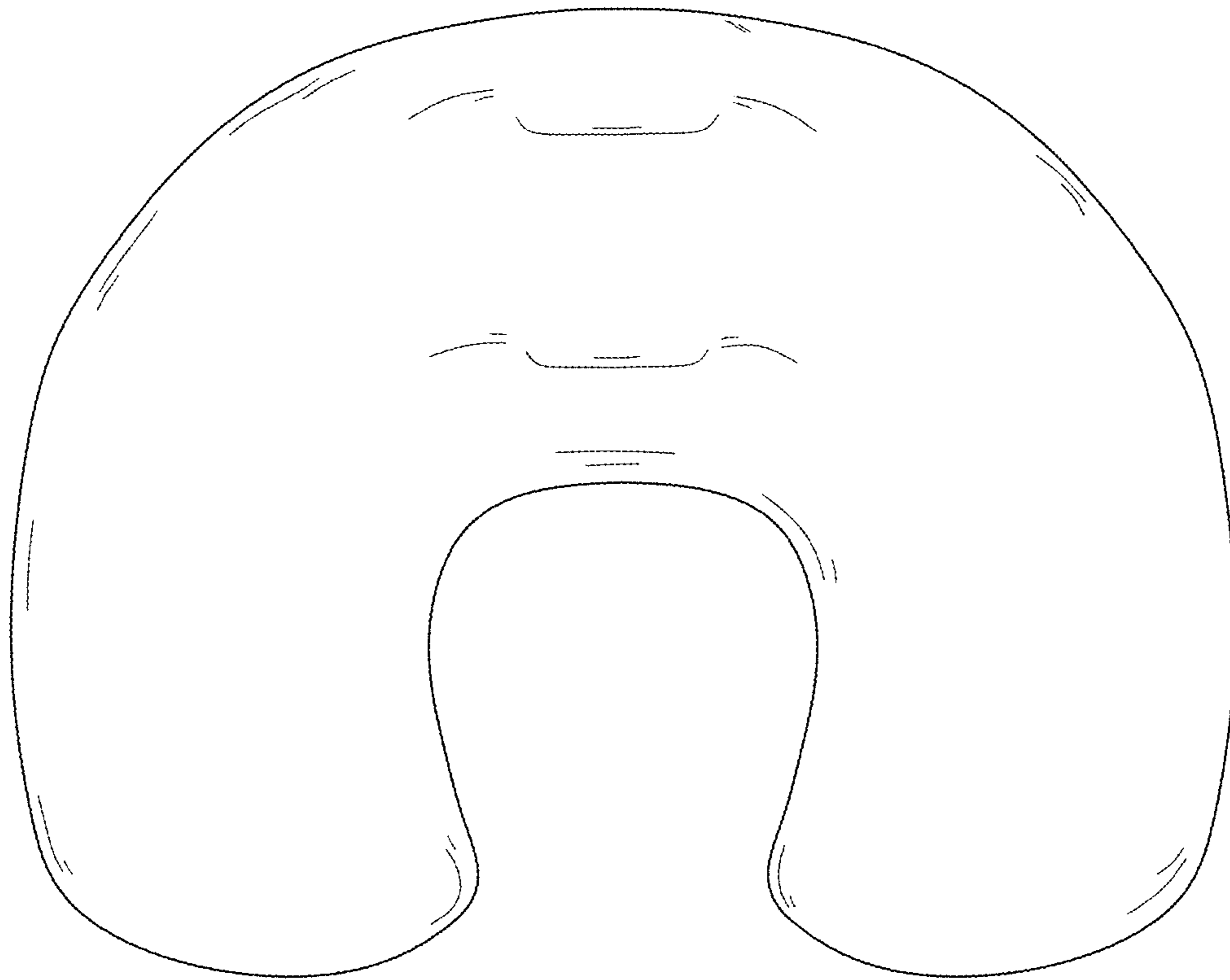

FIG. 2

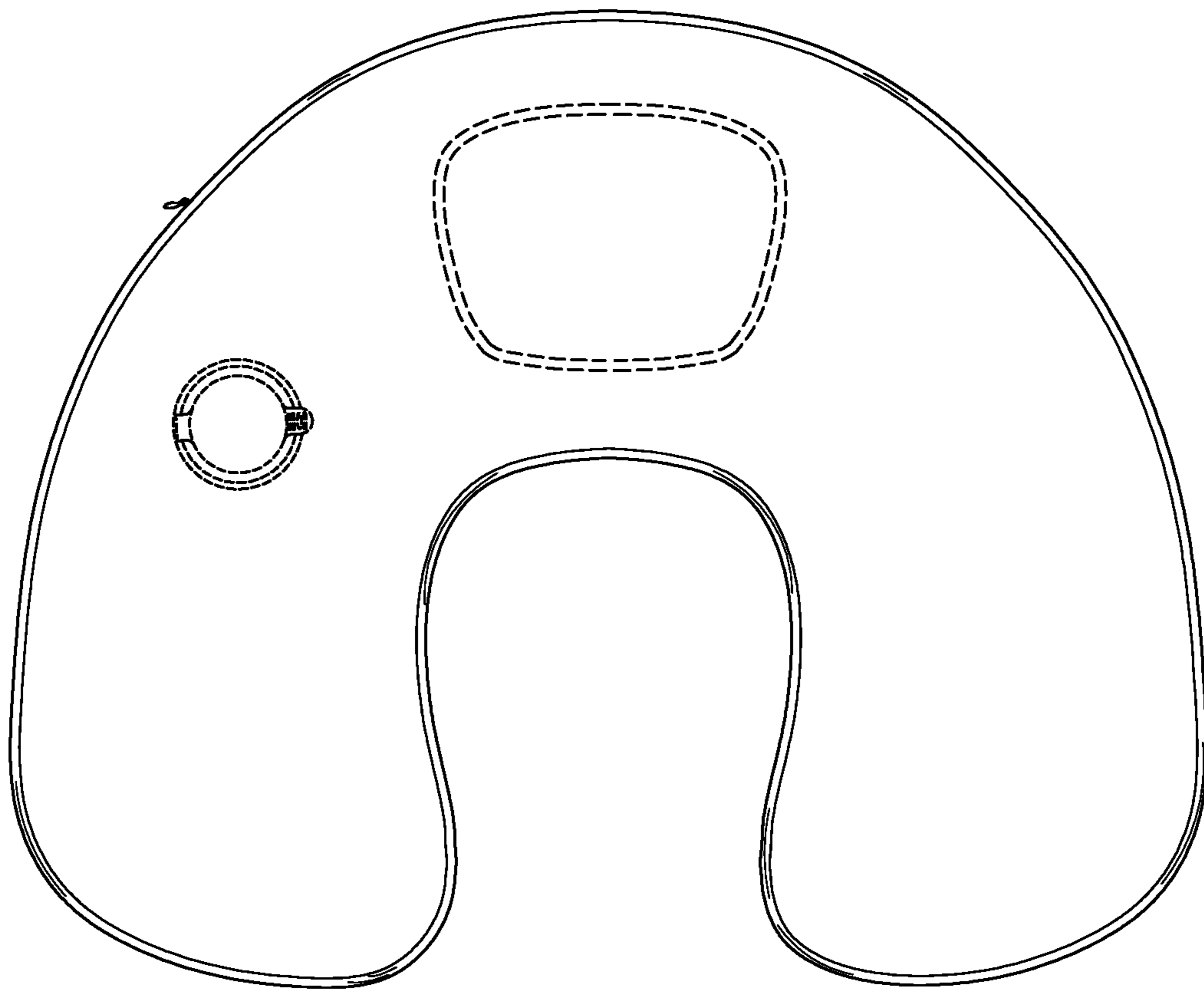

FIG. 3

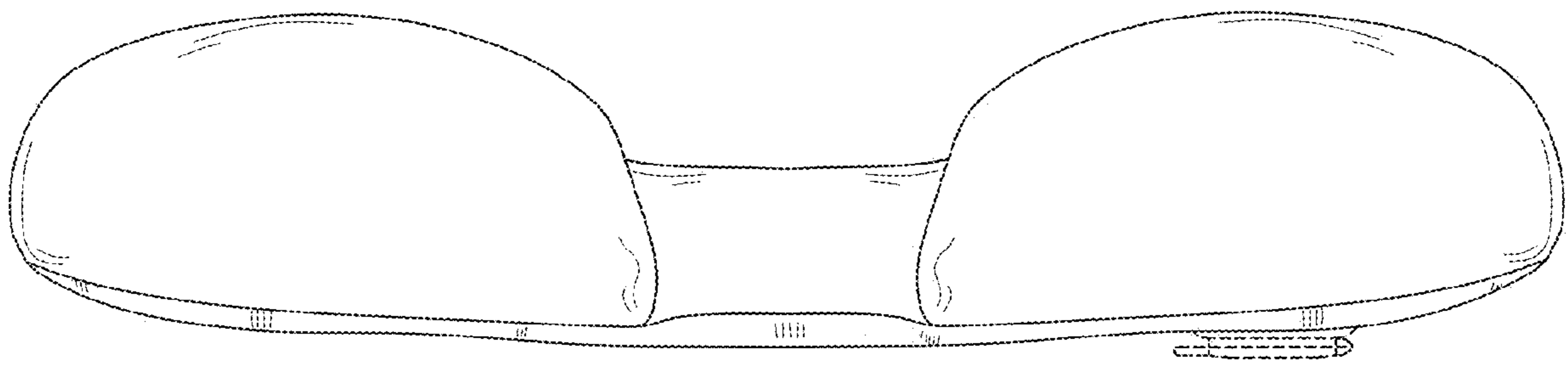

FIG. 4

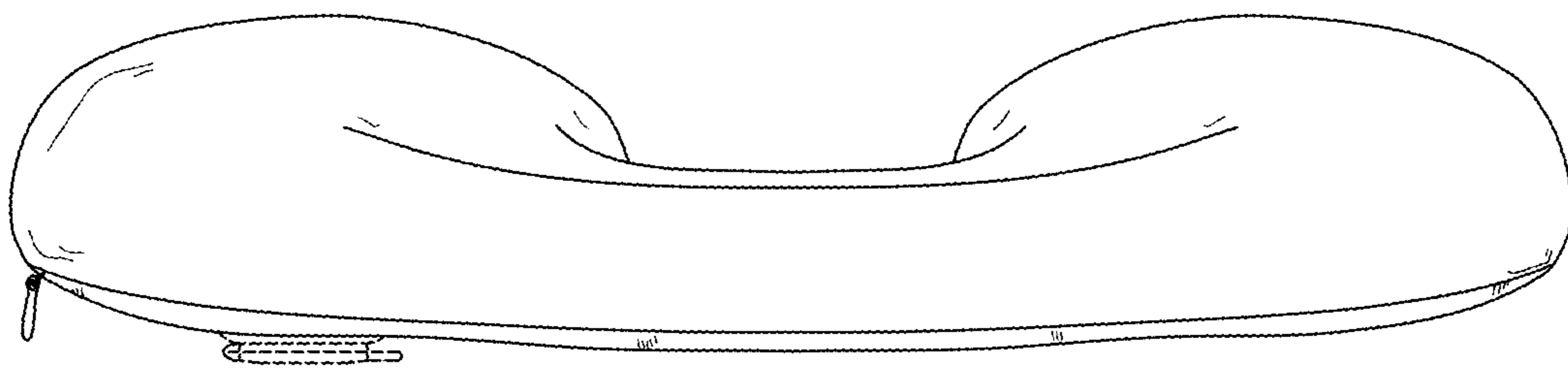

FIG. 5

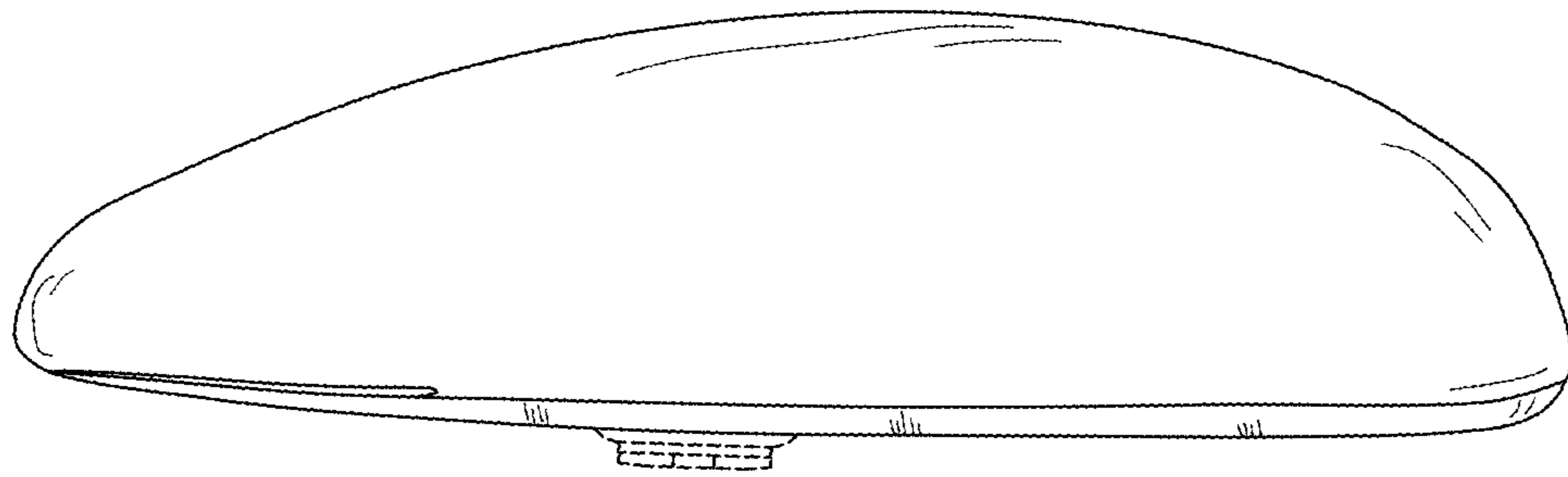

FIG. 6

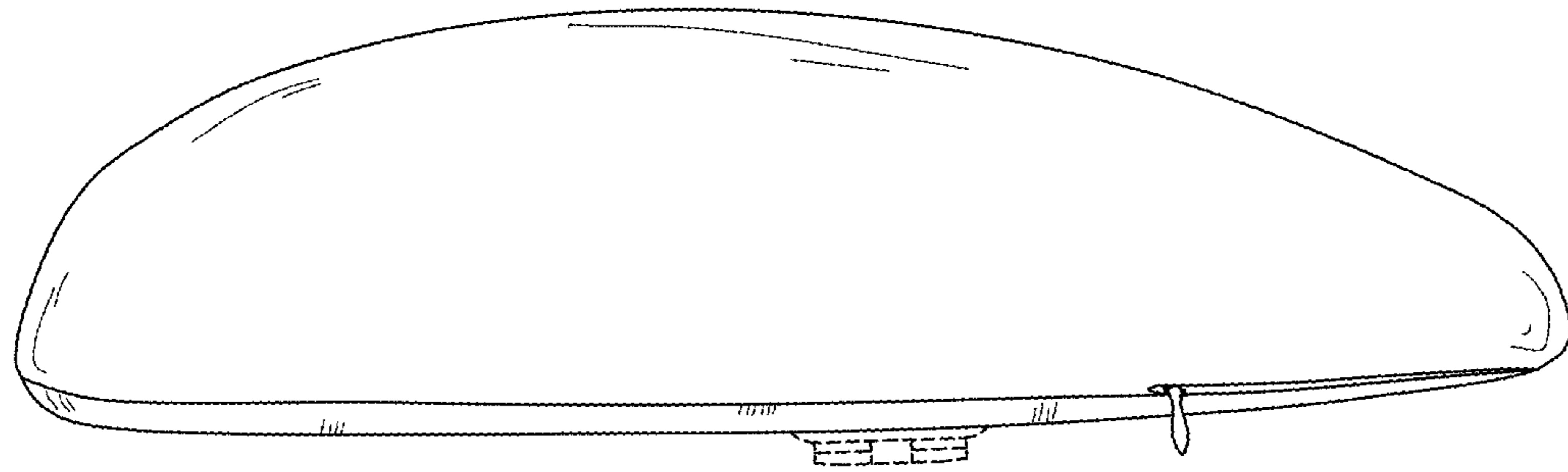

FIG. 7