



US00D911063S

(12) **United States Design Patent** (10) **Patent No.:** **US D911,063 S**
Nguyen (45) **Date of Patent:** **** Feb. 23, 2021**

(54) **LOUVER SLAT**
(71) Applicant: **Mark Nguyen**, Garland, TX (US)
(72) Inventor: **Mark Nguyen**, Garland, TX (US)
(**) Term: **15 Years**
(21) Appl. No.: **29/672,517**
(22) Filed: **Dec. 6, 2018**
(51) **LOC (13) Cl.** **06-10**
(52) **U.S. Cl.**
USPC **D6/580**
(58) **Field of Classification Search**
USPC D6/575-577, 579, 580; D13/155;
D25/119, 121, 136
CPC A47H 1/04; A47H 15/00; A47H 23/01;
E06B 2009/2622; E06B 2009/402; E06B
2009/407; E06B 9/26; E06B 9/28; E06B
9/323; E06B 9/36; E06B 9/386; E06B
9/388; E06B 9/40; E06B 9/42; E06B 9/58
See application file for complete search history.

(56) **References Cited**
U.S. PATENT DOCUMENTS
D25,087 S * 1/1896 Willson D8/393
D28,085 S * 12/1897 Sandstrom D25/121
D169,811 S * 6/1953 Heinley D6/580
D173,462 S * 11/1954 Schmoller D32/41
D242,035 S * 10/1976 Drawsky D25/119
D304,497 S * 11/1989 Briggs, Sr. H02S 20/30
D25/48.7
D362,934 S * 10/1995 Hansen D32/41
D368,344 S * 3/1996 Hansen D32/41
5,515,901 A * 5/1996 Hall E05D 15/264
160/206
D464,518 S * 10/2002 Griffiths D6/577
D481,575 S * 11/2003 Steinberg D6/580
D489,831 S * 5/2004 Glatz D25/136
D594,262 S * 6/2009 McNiel D6/577
D623,771 S * 9/2010 Vaes D25/136

D650,490 S * 12/2011 Maciulewicz D25/47.1
D660,461 S * 5/2012 Kotin D25/119
D662,227 S * 6/2012 Vaes D25/119
D746,203 S * 12/2015 Schlater D12/190
D746,746 S * 1/2016 Schlater D12/190
D783,865 S * 4/2017 Williams D25/119
D856,026 S * 8/2019 Teeters D6/577
D871,106 S * 12/2019 Chen D6/580
D892,517 S * 8/2020 Hunsberger E06B 9/264
D6/580
2011/0126992 A1 * 6/2011 Yordanova H02S 20/30
160/127
2013/0067835 A1 * 3/2013 Chou E06B 1/34
52/173.1

* cited by examiner

Primary Examiner — Kevin K Rudzinski
Assistant Examiner — Clare Ann Gannon

(57) **CLAIM**

The ornamental design for a louver slat, as shown and described.

DESCRIPTION

FIG. 1 is a perspective view of a louver slat showing my new design;
FIG. 2 is a front elevational view thereof;
FIG. 3 is a rear elevational view thereof;
FIG. 4 is a right side elevational view thereof;
FIG. 5 is a left side elevational view thereof;
FIG. 6 is a bottom plan view thereof;
FIG. 7 is a top plan view thereof; and,
FIG. 8 is a perspective view thereof, shown in use with a shutter frame and a plurality of louver slats.
The broken lines depicting a shutter frame and additional louver slats in FIG. 8 illustrate environmental structure and forms no part of the claimed design. All other broken lines depict portions of the louver slat that form no part of the claimed design.

1 Claim, 8 Drawing Sheets

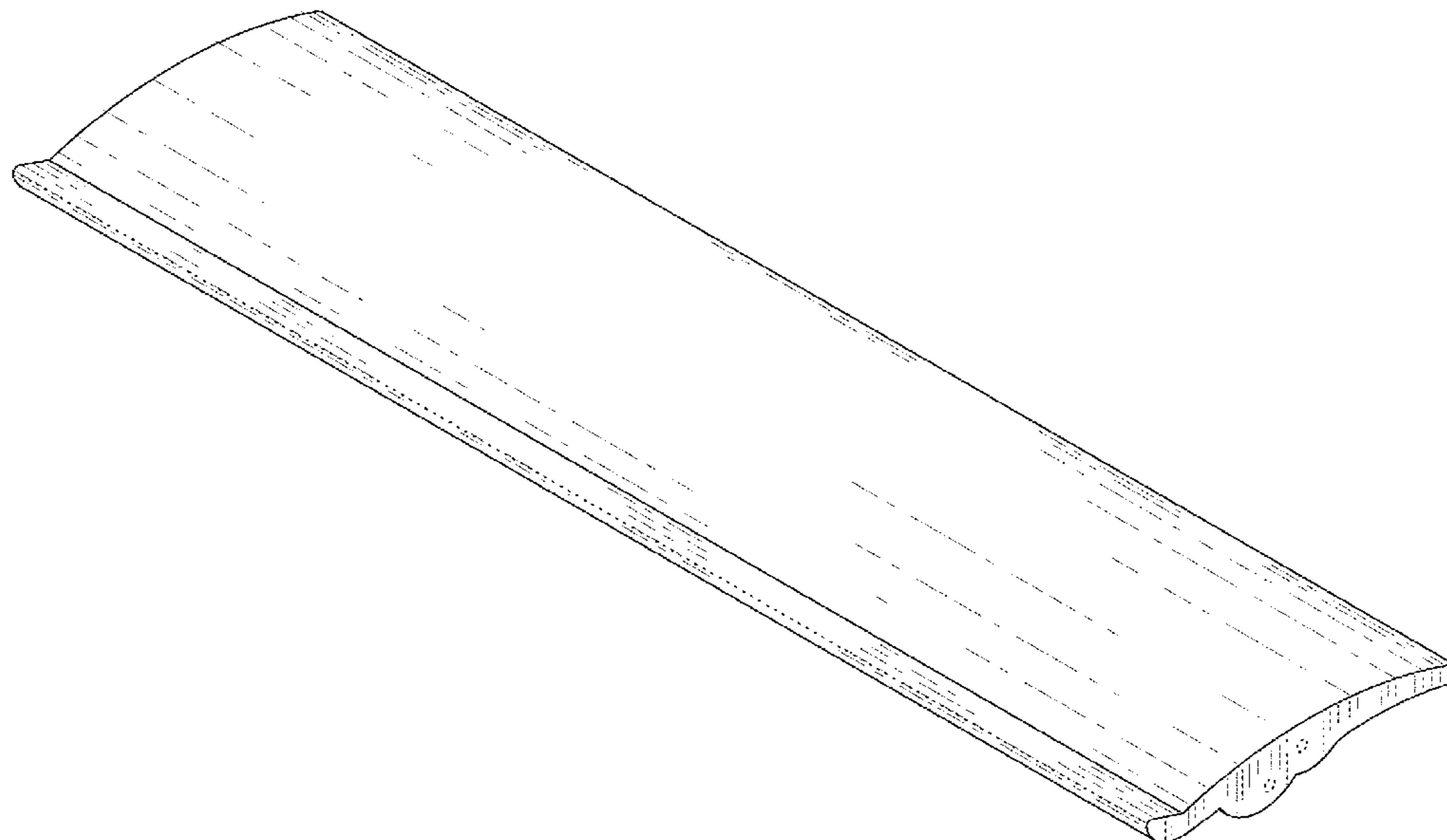

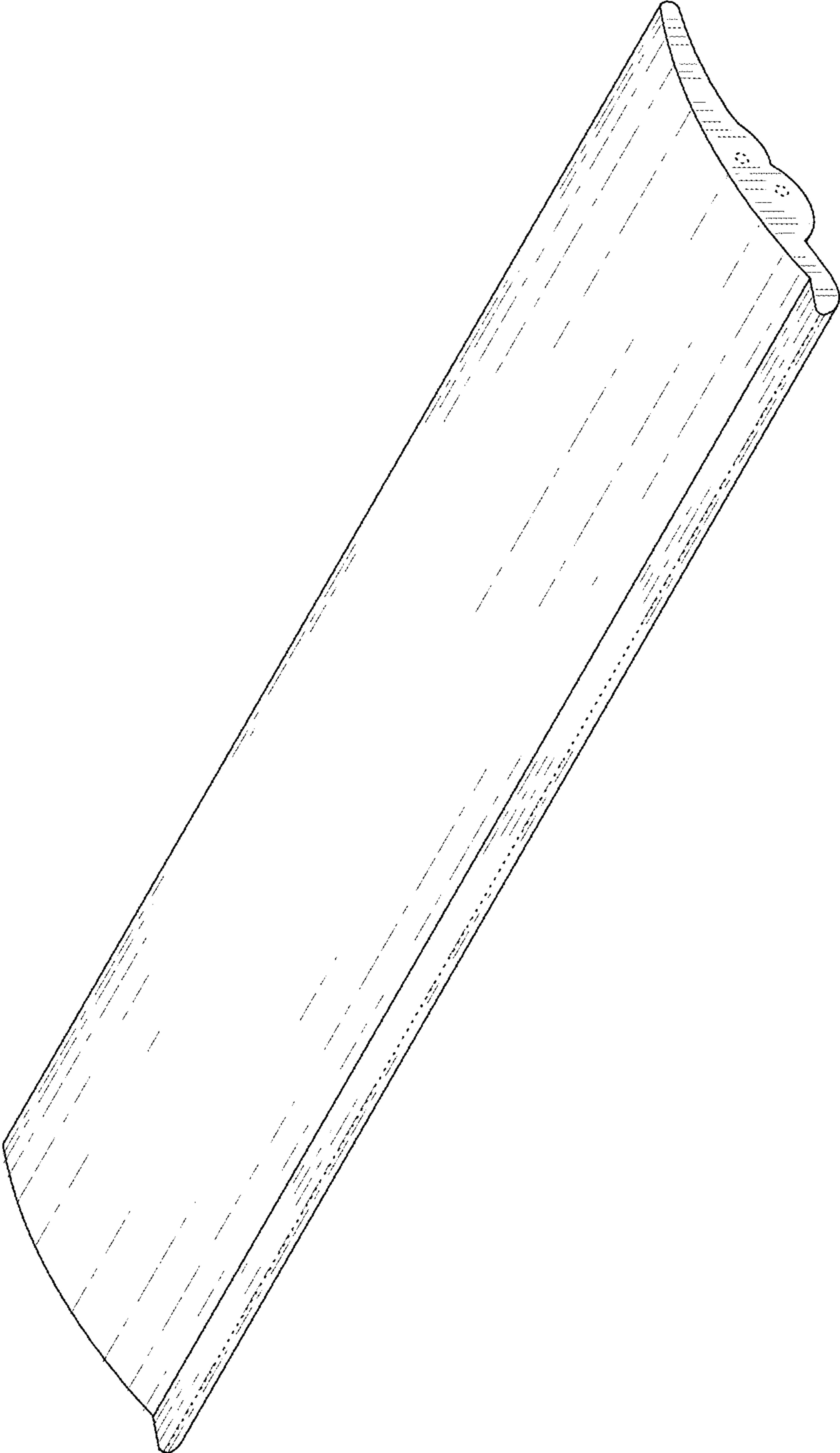

FIG. 1

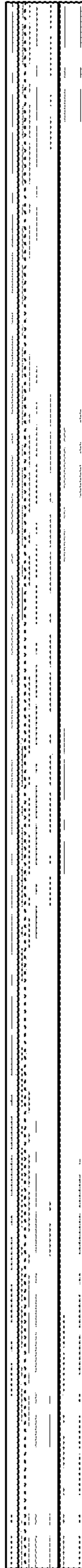

FIG. 2

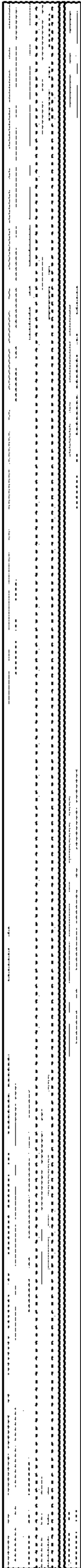

FIG. 3

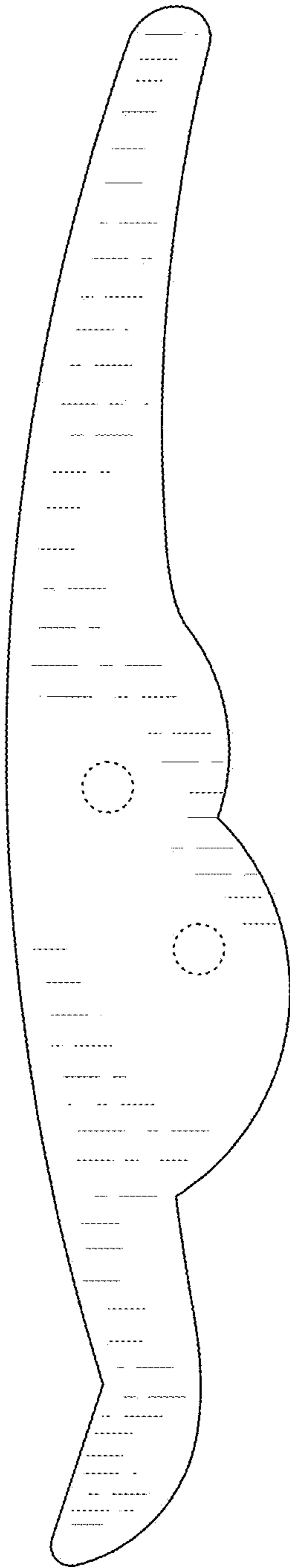

FIG. 4

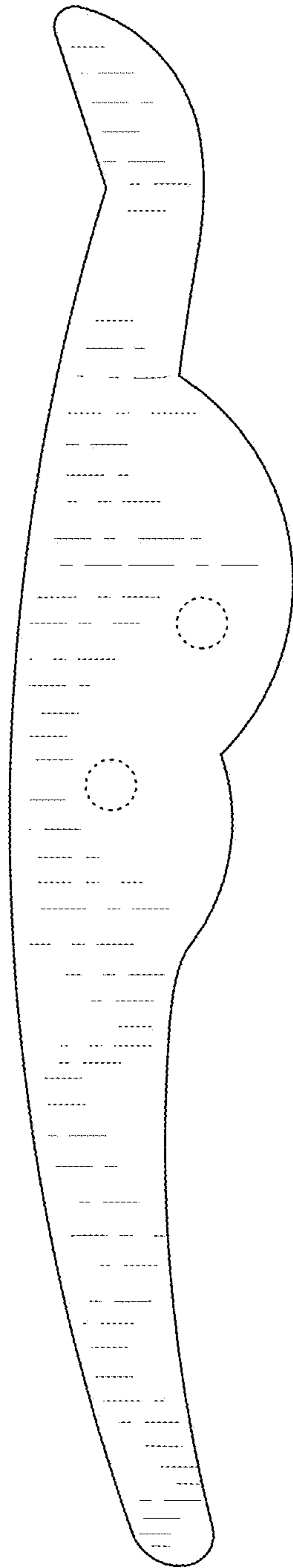

FIG. 5

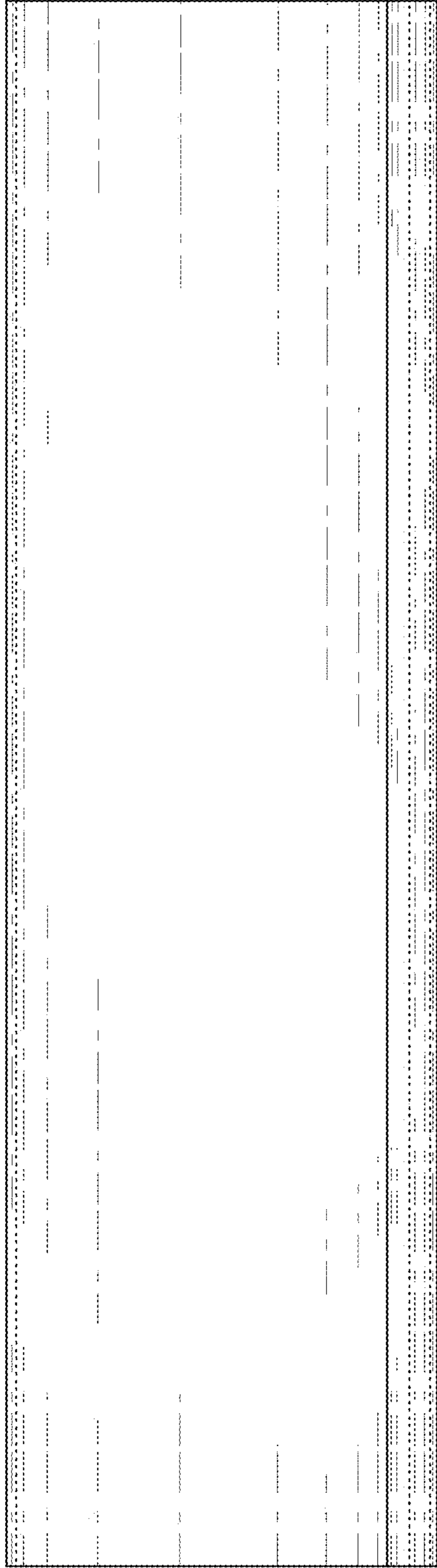

FIG. 6

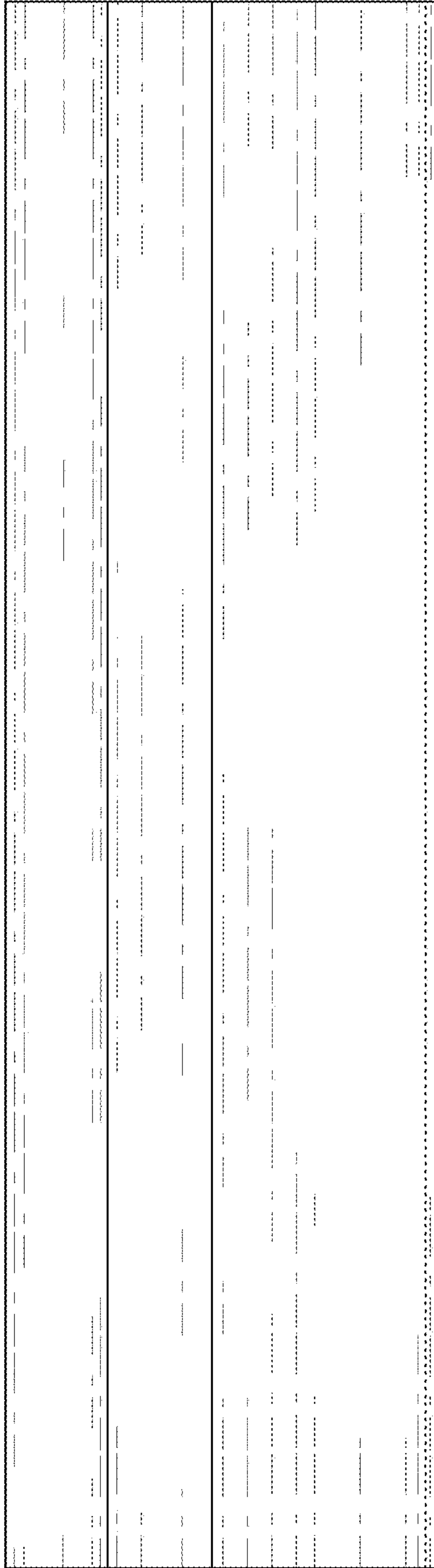

FIG. 7

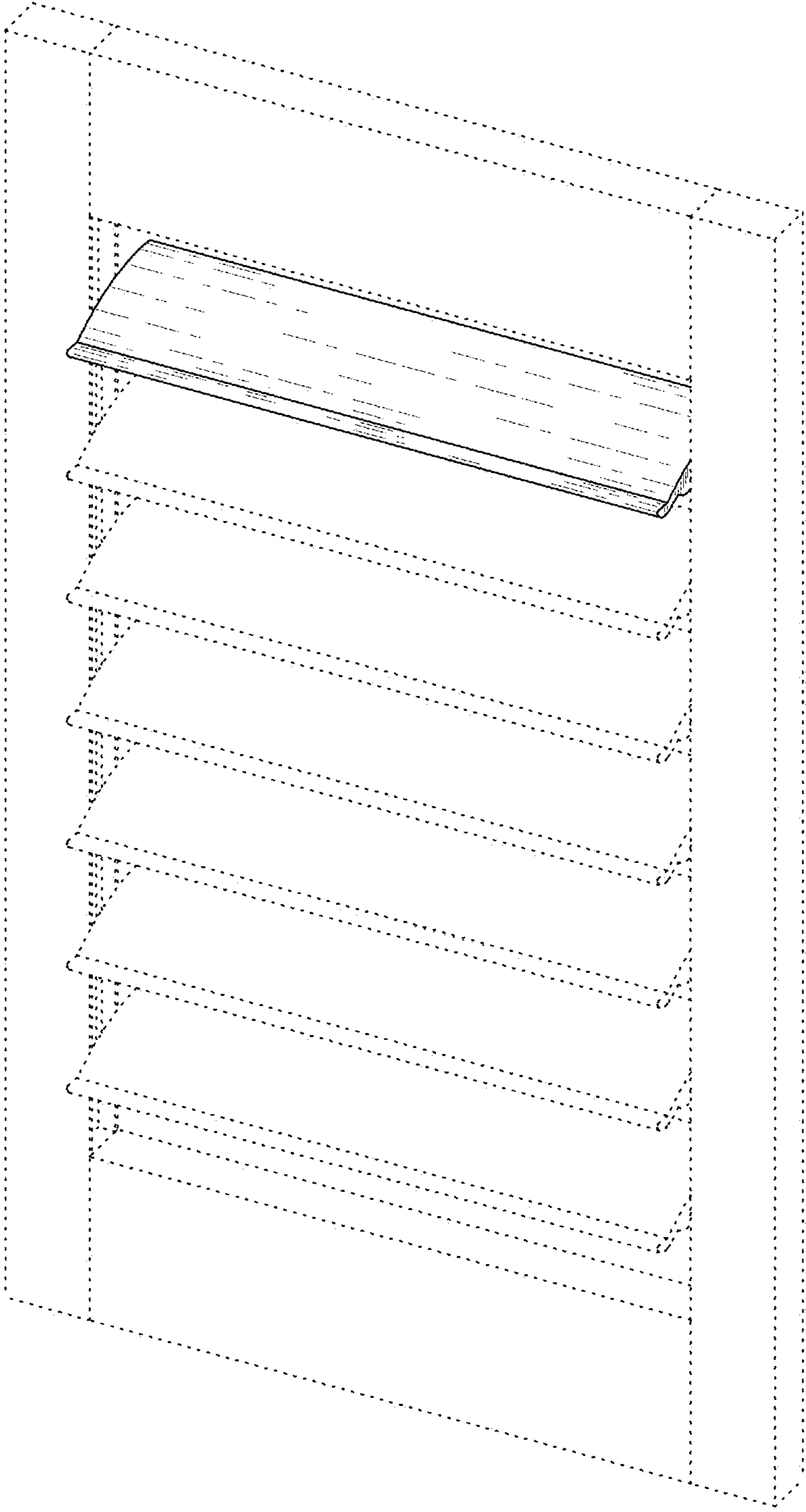

FIG. 8