



US00D911060S

(12) **United States Design Patent**
Machado

(10) **Patent No.:** **US D911,060 S**
(45) **Date of Patent:** **** Feb. 23, 2021**

- (54) **BED**
- (71) Applicant: **Inter IKEA Systems B.V.**, LN Delft (NL)
- (72) Inventor: **Paulin Machado**, Malmö (SE)
- (73) Assignee: **INTER IKEA SYSTEMS B.V.**, Delft (NL)
- (**) Term: **15 Years**
- (21) Appl. No.: **29/691,742**
- (22) Filed: **May 18, 2019**
- (30) **Foreign Application Priority Data**
Jan. 11, 2019 (EM) 005993581
- (51) **LOC (13) Cl.** **06-02**
- (52) **U.S. Cl.**
USPC **D6/395**
- (58) **Field of Classification Search**
USPC D6/382, 383, 392, 393, 394, 395, 718, D6/718.13, 718.21
CPC A47C 19/00; A47C 19/021; A47C 19/022; A47C 19/04; A47C 19/12
See application file for complete search history.

- D41,570 S * 7/1911 Moore A47C 19/022 D6/395
- D41,571 S * 7/1911 Moore D6/395
- D49,273 S * 6/1916 Murphy D6/389
- 1,407,234 A * 2/1922 Storey A47C 19/12 5/176.1
- 1,646,116 A * 10/1927 Smith A47C 17/40 5/168
- 4,281,424 A * 8/1981 Singer A47C 19/022 5/282.1
- D659,443 S * 5/2012 Hallberg D6/708.16
- D660,046 S * 5/2012 al-Rawi D6/393
- 2019/0104857 A1 * 4/2019 Chung A47C 19/021

- (56) **References Cited**
U.S. PATENT DOCUMENTS
D20,458 S * 1/1891 Zimskind D6/394
D26,449 S * 12/1896 Merritt D6/395
D26,855 S * 3/1897 Foster D6/395
594,016 A * 11/1897 Hompe A47C 19/022 5/279.1
790,799 A * 5/1905 Mardis A47C 19/00 5/221
874,385 A * 12/1907 Blomquist A47F 7/30 5/287

OTHER PUBLICATIONS

Ferndale Metal Bed, target.com, site visited Oct. 30, 2020, review date with image from 2019, available online at <https://www.target.com/p/queen-ferndale-metal-bed-black-threshold-8482/-/A-53498431> (Year: 2019).*

(Continued)

Primary Examiner — Cathron C Brooks
(74) *Attorney, Agent, or Firm* — Tucker Ellis LLP

(57) **CLAIM**

The ornamental design for a bed, as shown and described.

DESCRIPTION

FIG. 1 is a front-right-top perspective view of a bed showing my new design;
FIG. 2 is front view thereof;
FIG. 3 is a rear view thereof;
FIG. 4 is a left side view thereof;
FIG. 5 is a right side view thereof;
FIG. 6 is a top view thereof, shown in reduced scale; and,
FIG. 7 is a bottom view thereof.
The broken lines illustrate portions of the bed that form no part of the claimed design.

1 Claim, 7 Drawing Sheets

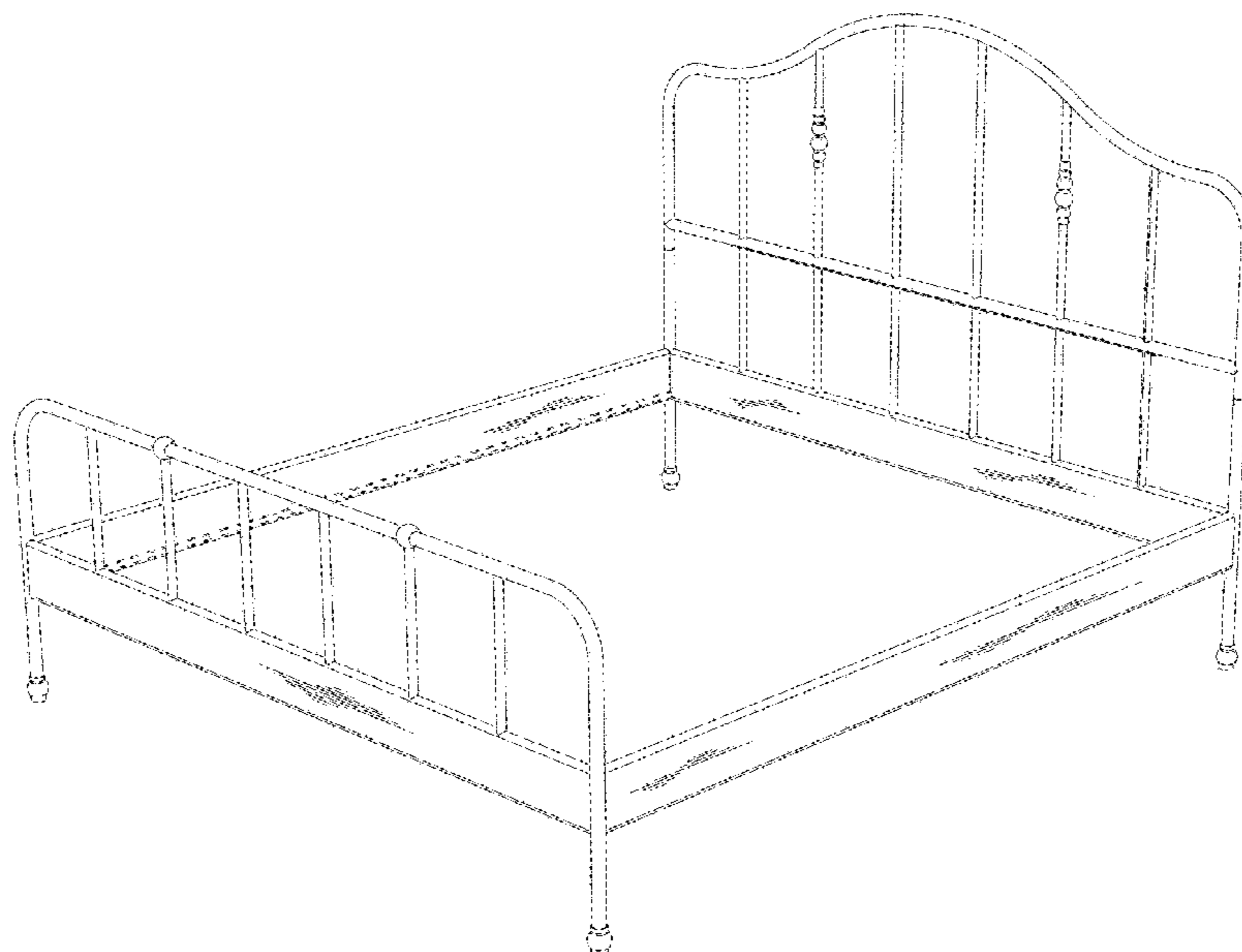

(56)

References Cited

OTHER PUBLICATIONS

Bushwick Metal Bed, Novogratz, amazon.com, site visited Oct. 30, 2020, review date with image from Sep. 23, 2017, available online at <https://www.amazon.com/Novogratz-Bushwick-Metal-Modern-Design/dp/B07C2DLMJM?th=1> (Year: 2017).*

* cited by examiner

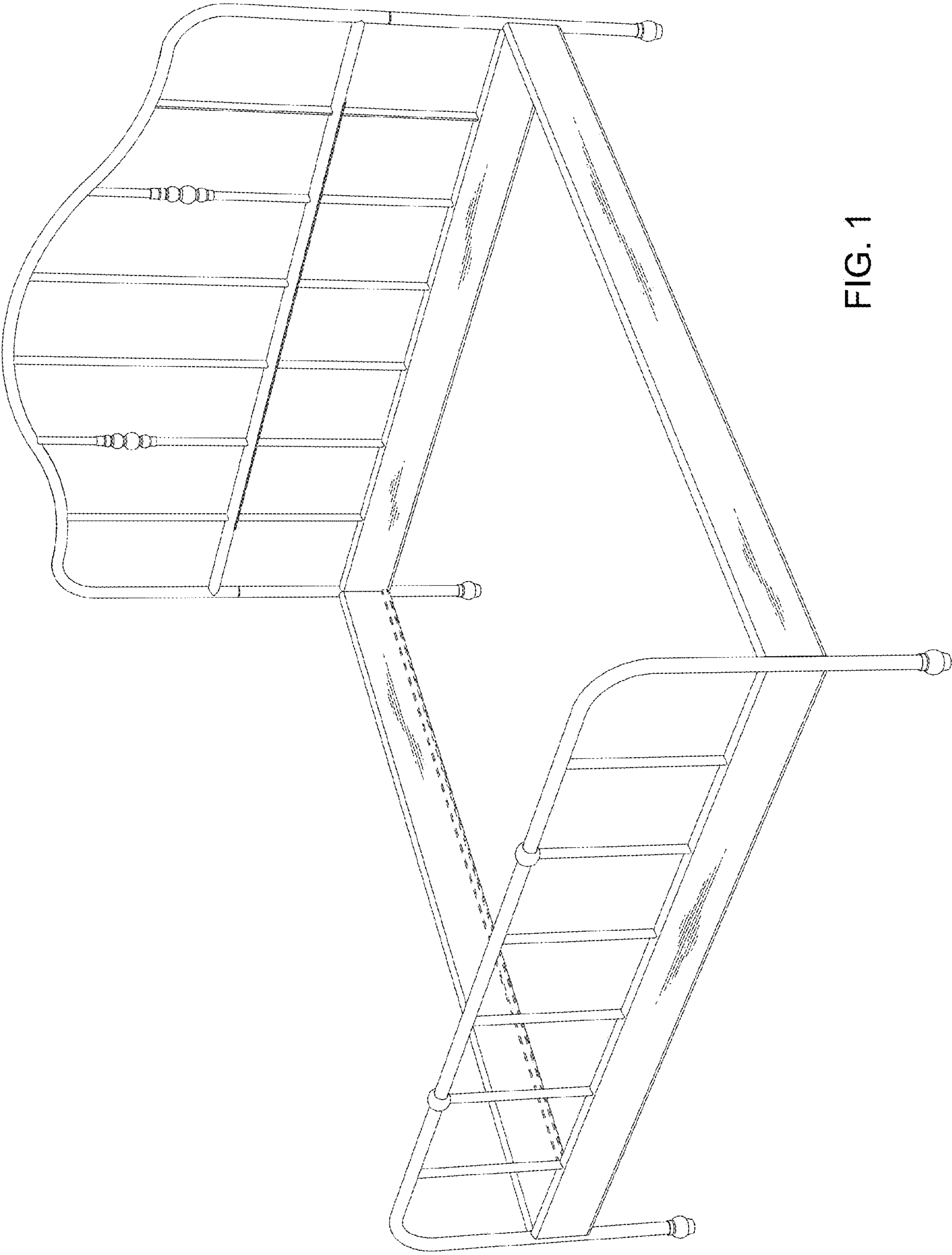

FIG. 1

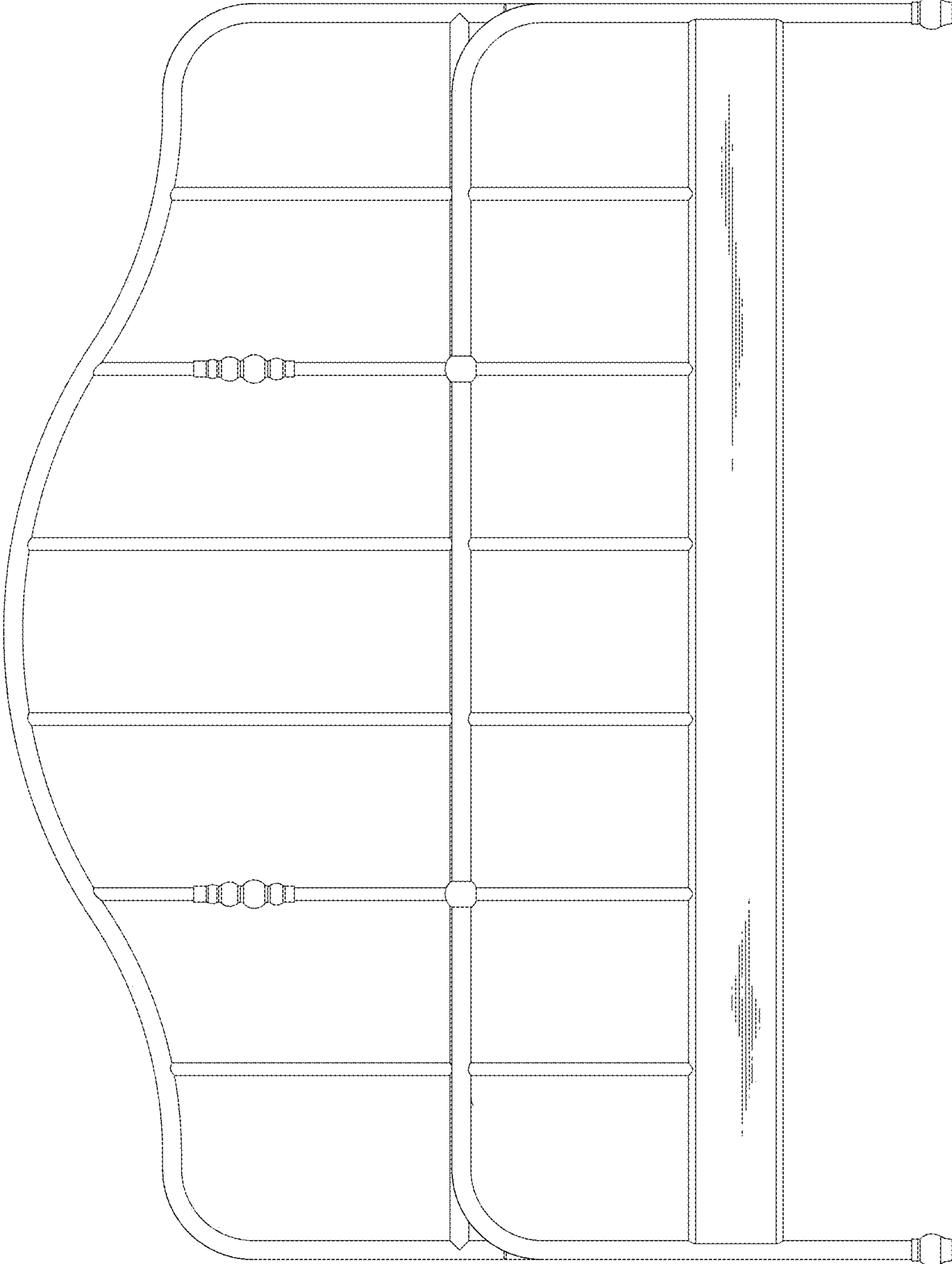

FIG. 2

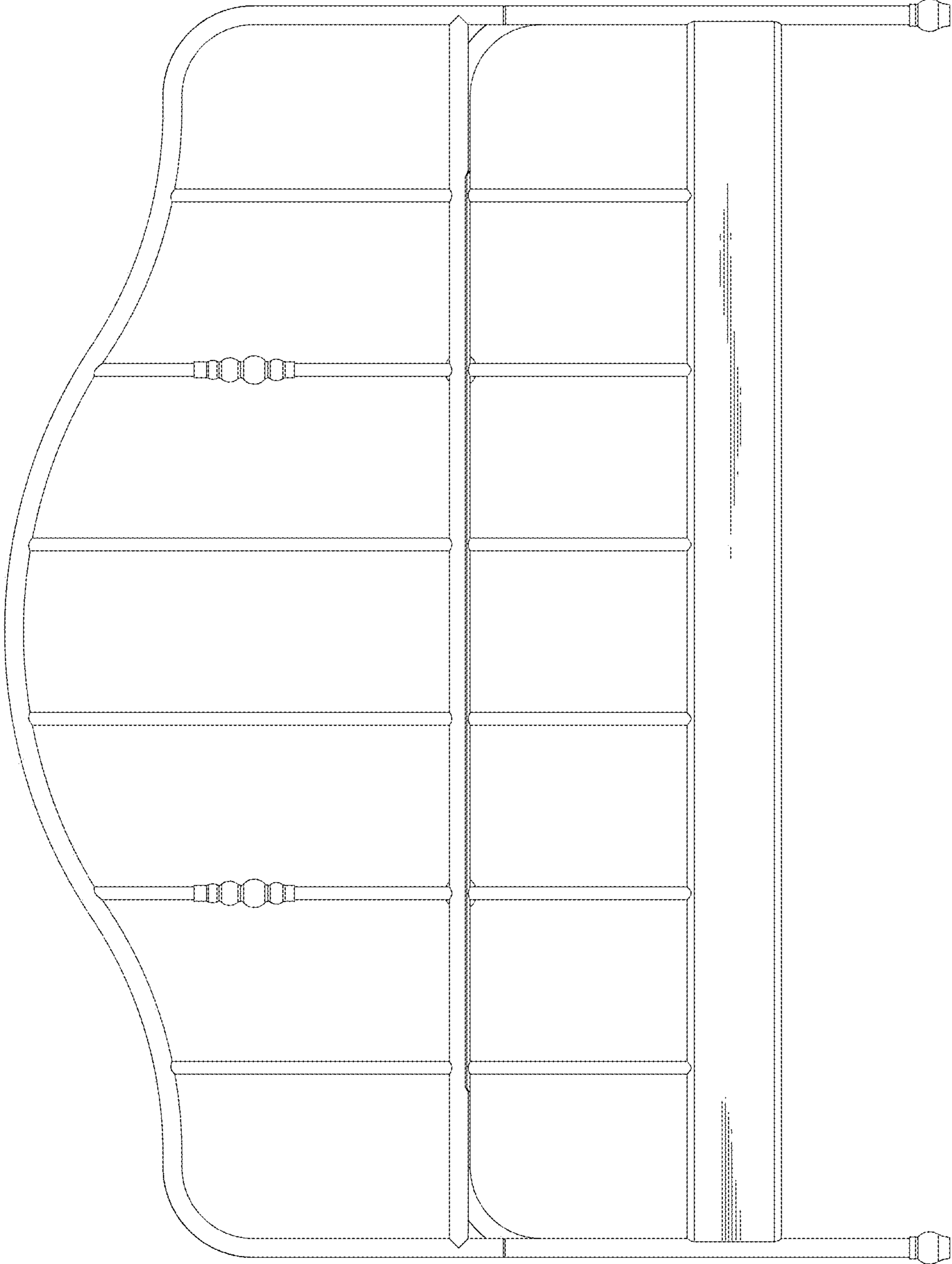

FIG. 3

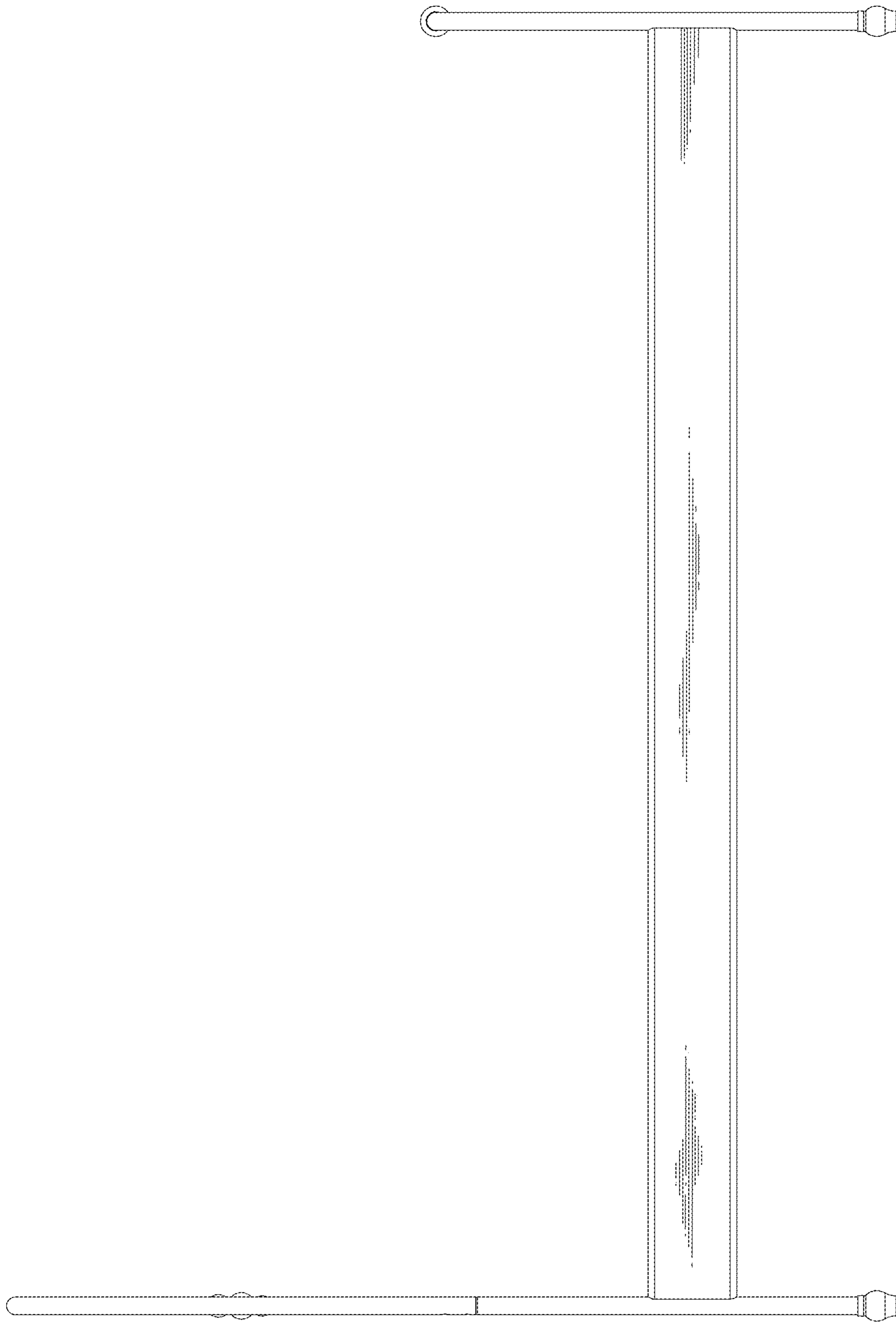

FIG. 4

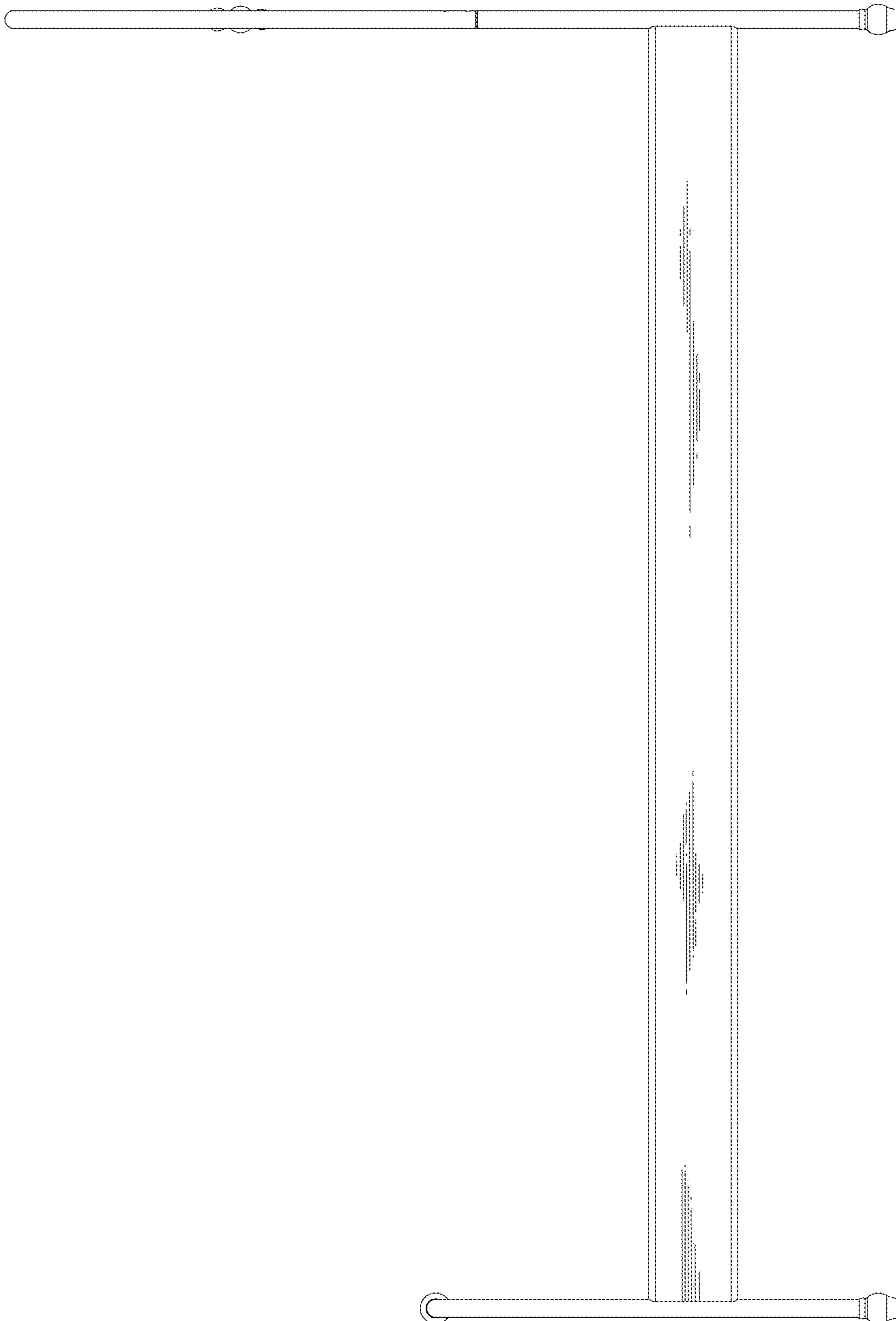

FIG. 5

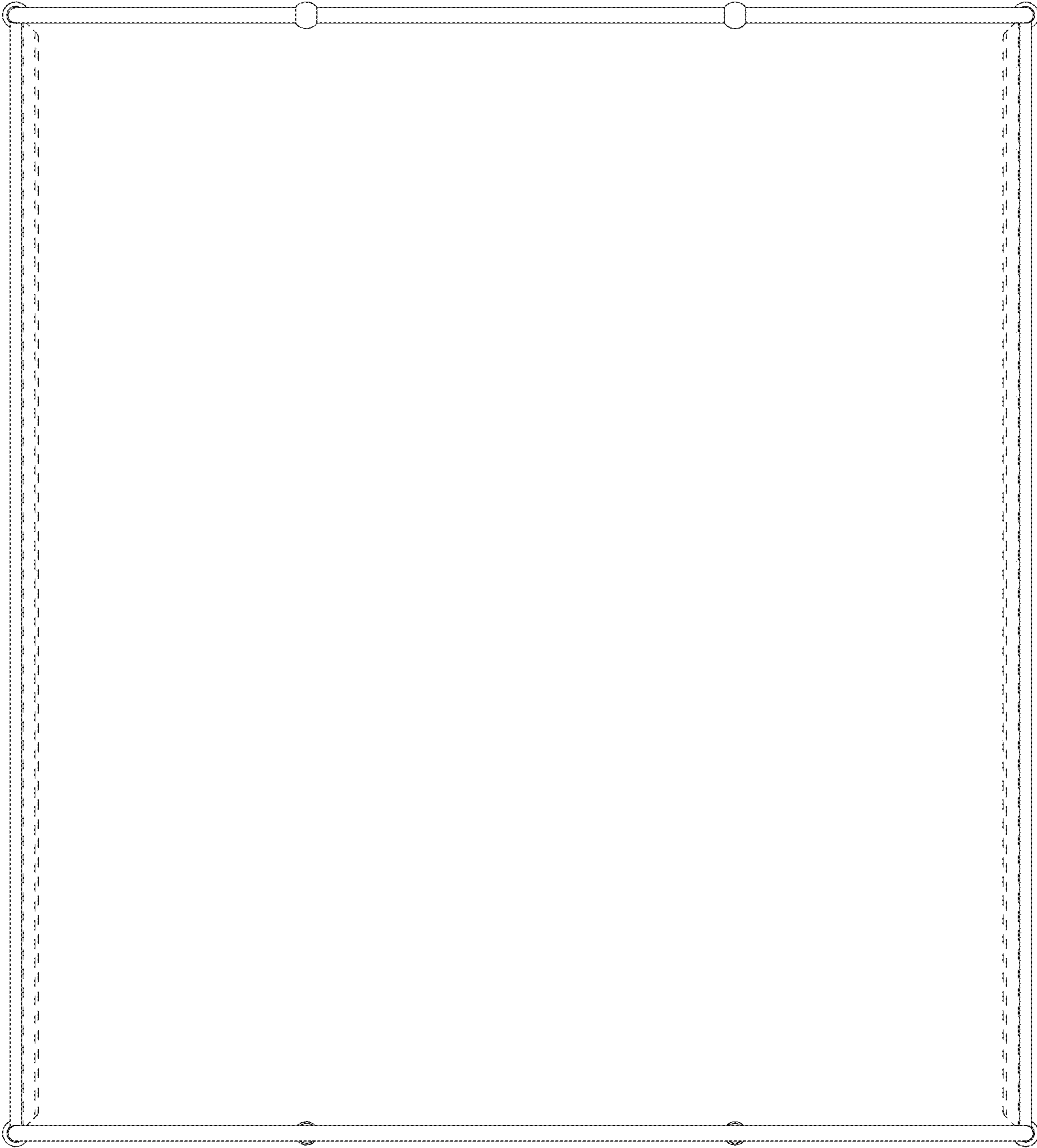

FIG. 6

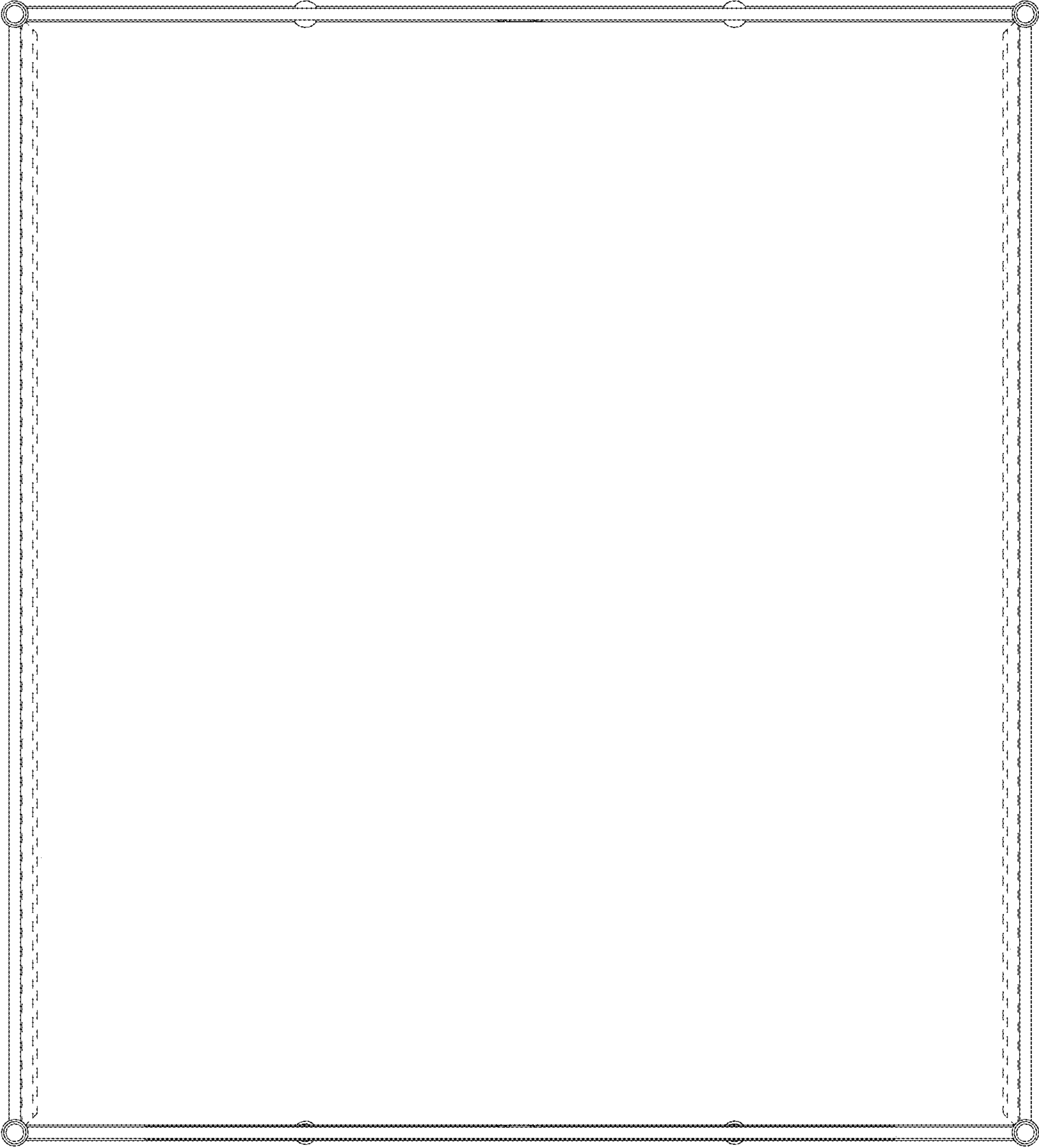

FIG. 7