



US00D911026S

(12) **United States Design Patent**
Stevens

(10) **Patent No.:** **US D911,026 S**

(45) **Date of Patent:** **** Feb. 23, 2021**

(54) **PERSONAL EFFECTS HOLDER**

Primary Examiner — T Chase Nelson

(71) Applicant: **Darryl Stevens**, Buffalo Grove, IL (US)

(72) Inventor: **Darryl Stevens**, Buffalo Grove, IL (US)

(**) Term: **15 Years**

(21) Appl. No.: **29/685,147**

(22) Filed: **Mar. 26, 2019**

(51) **LOC (13) Cl.** **03-01**

(52) **U.S. Cl.**
USPC **D3/265**; D3/266

(58) **Field of Classification Search**
USPC D3/207, 215, 219, 229, 263–266, 299,
D3/211; D12/417; D16/330, 339;
24/3.3, 3.7, 3.8, 563; 206/5, 5.1, 6;
248/902; 351/112, 155
CPC A45C 11/04; A45C 11/005; A47F 7/02;
A47F 7/021

See application file for complete search history.

(56) **References Cited**

U.S. PATENT DOCUMENTS

D203,737 S *	2/1966	Friedman	D99/34
D361,202 S *	8/1995	Seach	D3/266
D445,251 S *	7/2001	Newler	G02C 3/04
				D3/215
D463,104 S *	9/2002	Ames	D3/207
D487,344 S *	3/2004	Sieger	D3/219
D518,595 S *	4/2006	Morganfield, Jr.	D27/161
D605,398 S *	12/2009	Rodriguez	D3/219
D630,835 S *	1/2011	Easley	D3/203.1
8,166,689 B1 *	5/2012	Emshoff	A47G 1/12
				40/800
8,739,368 B2 *	6/2014	Murphy, Jr.	A45F 5/02
				24/3.3
D717,537 S *	11/2014	Tsai	A47G 1/12
				D3/215
D718,528 S *	12/2014	Garavaglia	D3/264
D723,274 S *	3/2015	Almanaseer	D3/264

(Continued)

(57) **CLAIM**

The ornamental design for a personal effects holder, as shown and described.

DESCRIPTION

FIG. 1 is a front elevational view of a first embodiment of a personal effects holder showing my design; FIG. 2 is a left side elevational view thereof; FIG. 3 is a rear elevational view thereof; FIG. 4 is a rear perspective view thereof; FIG. 5 is a right side elevational view thereof; FIG. 6 is a top plan view thereof; FIG. 7 is a bottom plan view thereof; FIG. 8 is a first front perspective view thereof; FIG. 9 is a second front perspective view thereof; FIG. 10 is a front elevational view thereof including an insert; FIG. 11 is a front elevation view of a second embodiment of a personal effects holder showing my design; FIG. 12 is a left side elevational view thereof; FIG. 13 is a rear elevational view thereof; FIG. 14 is a rear perspective view thereof; FIG. 15 is a right side elevational view thereof; FIG. 16 is a top plan view thereof; FIG. 17 is a bottom plan view thereof; FIG. 18 is a first front perspective view thereof; FIG. 19 is a second front perspective view thereof; and, FIG. 20 is a front elevational view thereof including an insert.

The broken lines showing an insert in the FIGS. 10 and 20 views show environmental structure associated with the design in a condition of use and form no part of the claimed design.

1 Claim, 20 Drawing Sheets

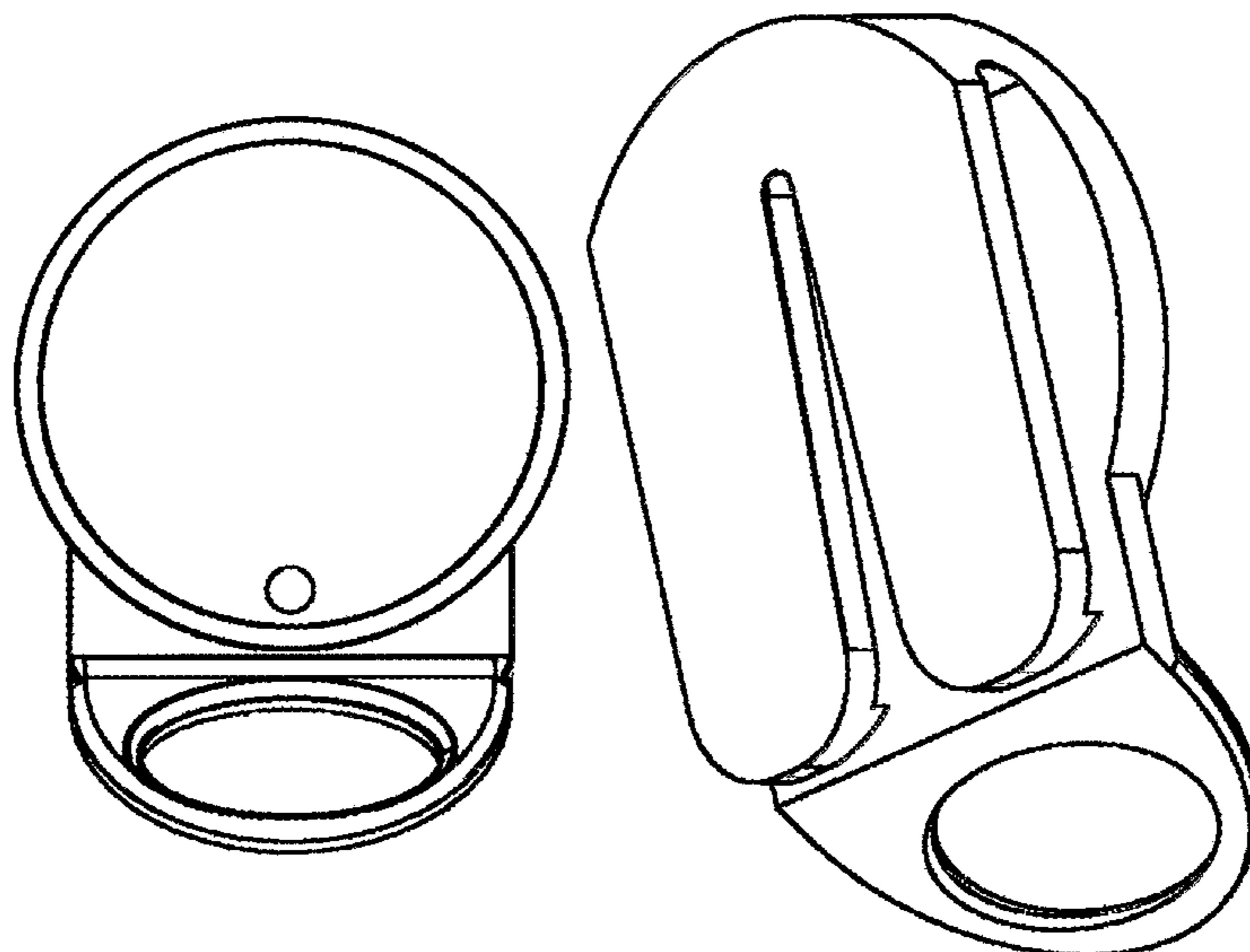

(56)

References Cited

U.S. PATENT DOCUMENTS

D756,117 S * 5/2016 Harris A45F 5/02
D3/264
D762,507 S * 8/2016 Pipkin D10/106.9
D781,571 S * 3/2017 Moerer D3/215
D811,740 S * 3/2018 Harrison A45F 5/02
D3/264
D836,337 S * 12/2018 Stark D3/266
D877,497 S * 3/2020 Stevens D3/219
D888,411 S * 6/2020 Roh D3/215
2003/0229971 A1* 12/2003 Coyne A45F 5/02
24/3.3
2004/0200872 A1* 10/2004 Wissman A45F 5/02
224/604
2010/0294675 A1* 11/2010 Mangano A45C 11/04
206/5
2016/0025996 A1* 1/2016 Bacon A45F 5/02
24/3.3

* cited by examiner

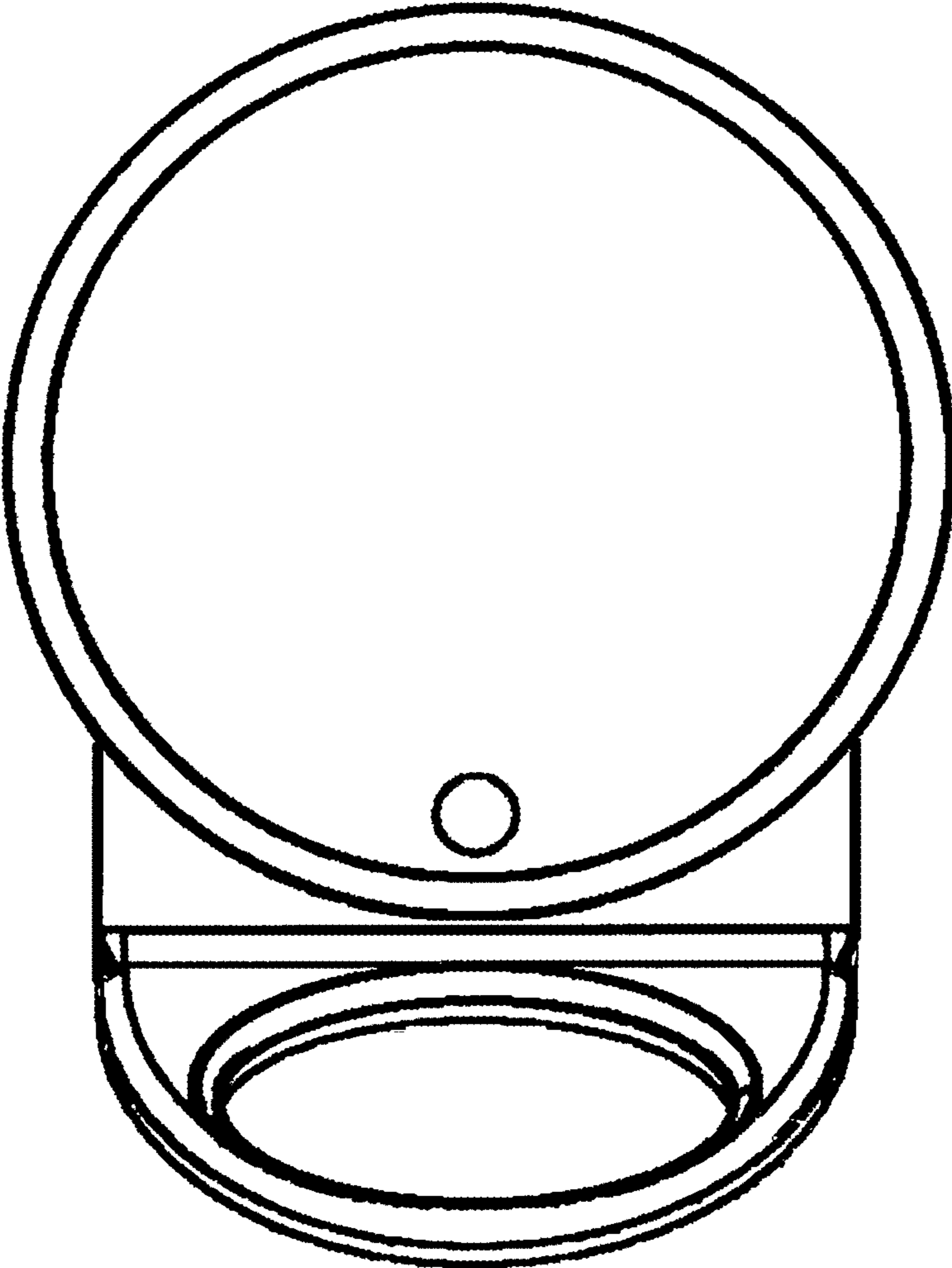

Fig. 1

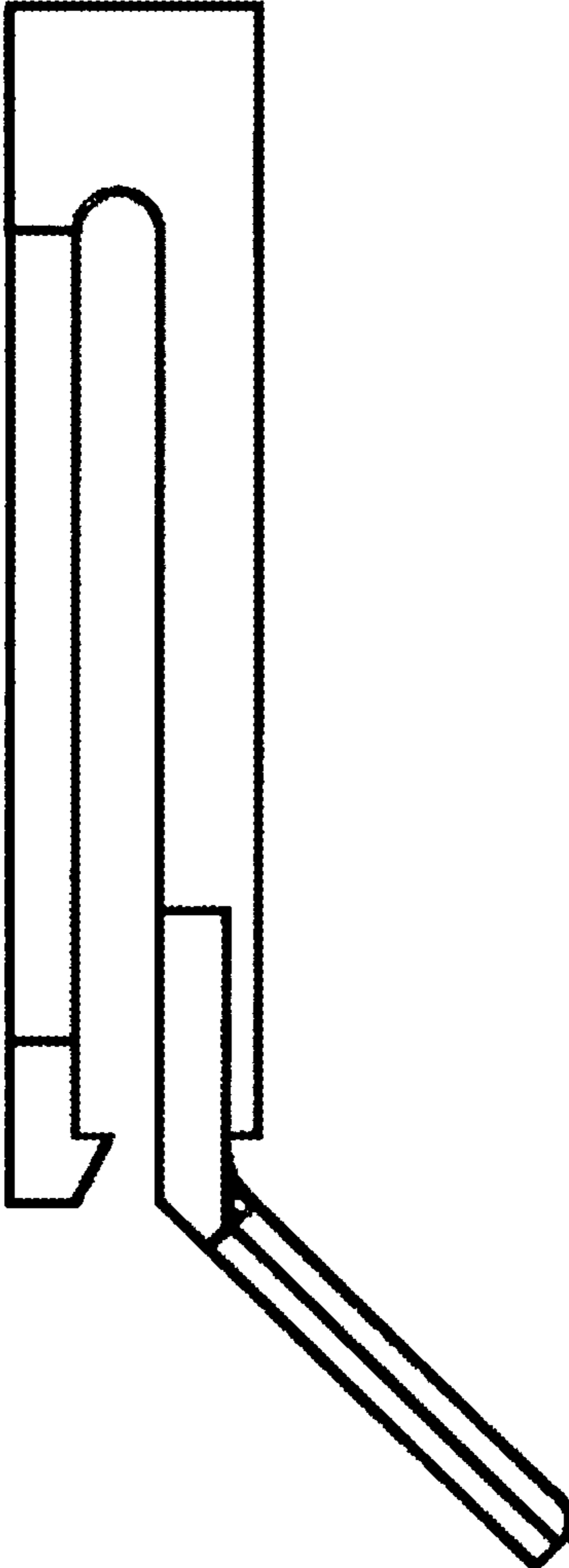

Fig. 2

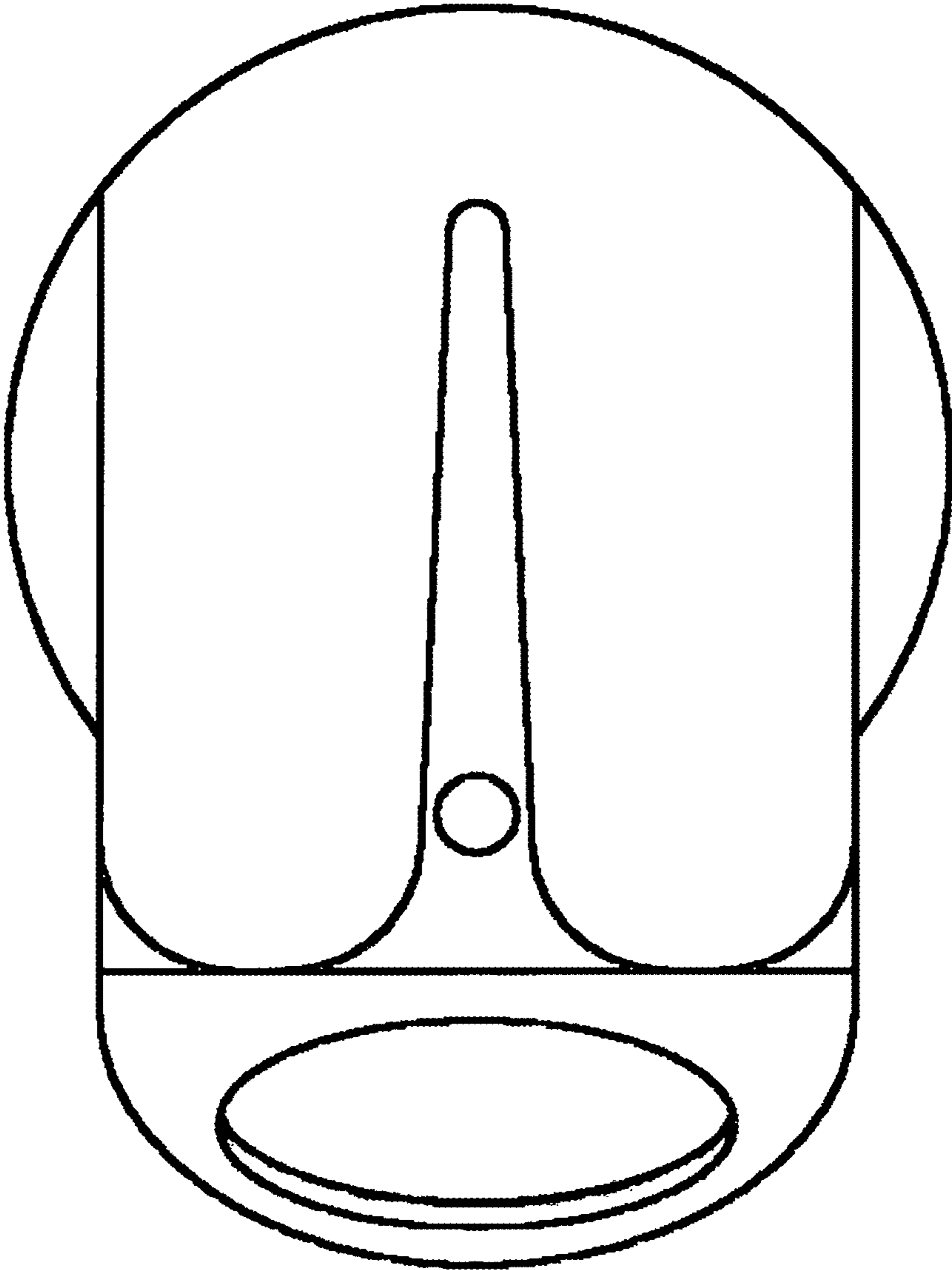

Fig. 3

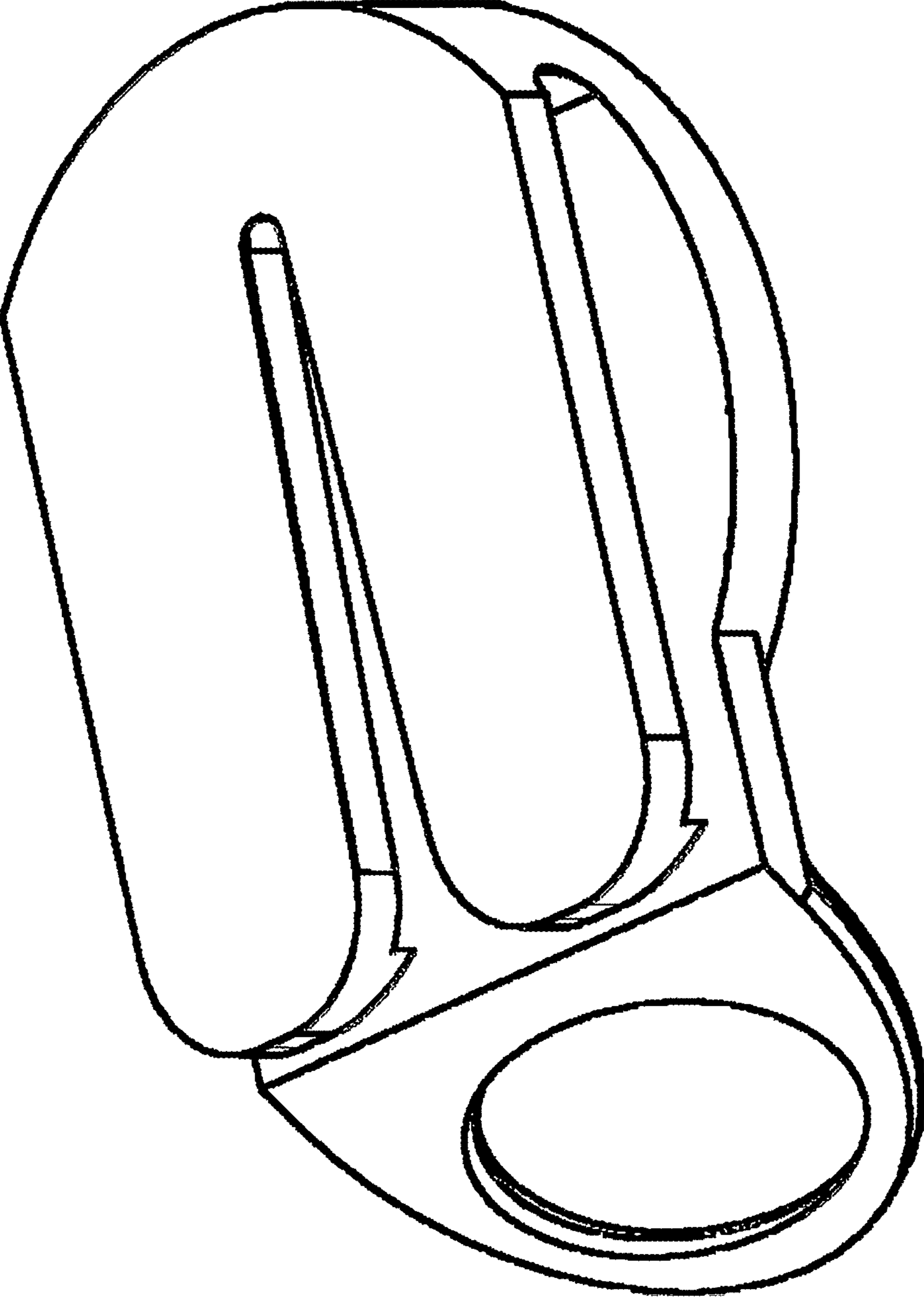

Fig. 4

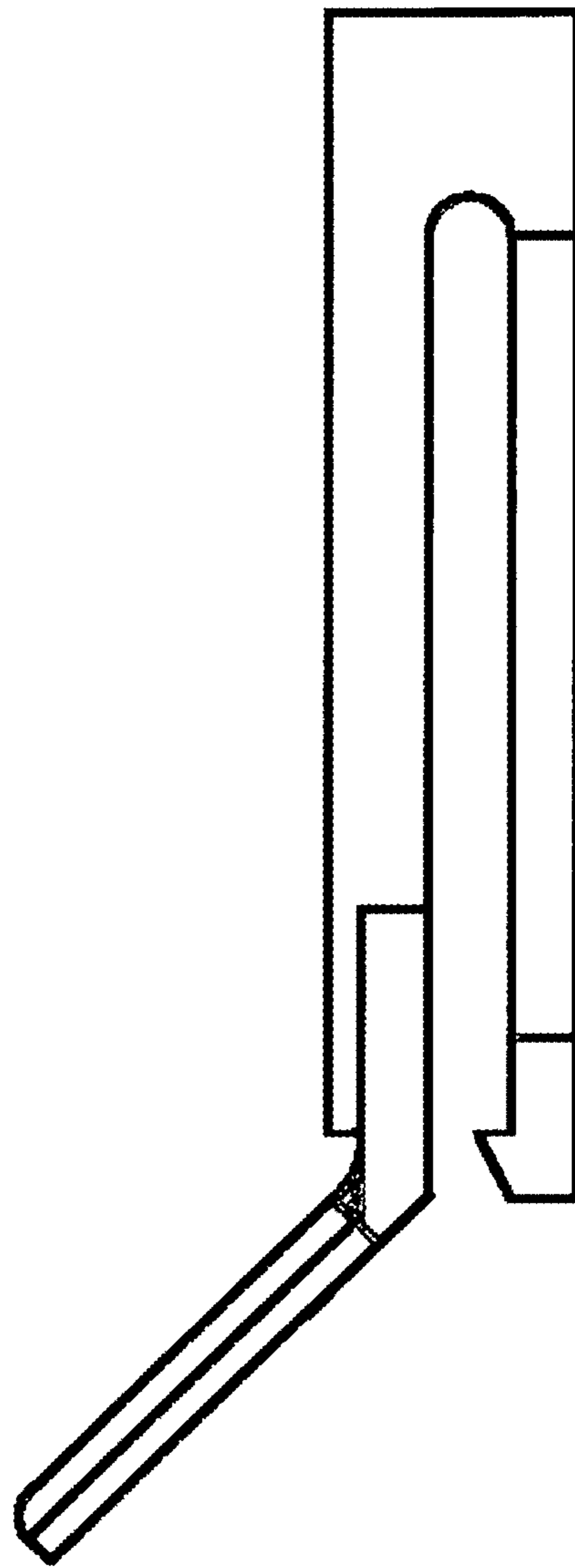

Fig. 5

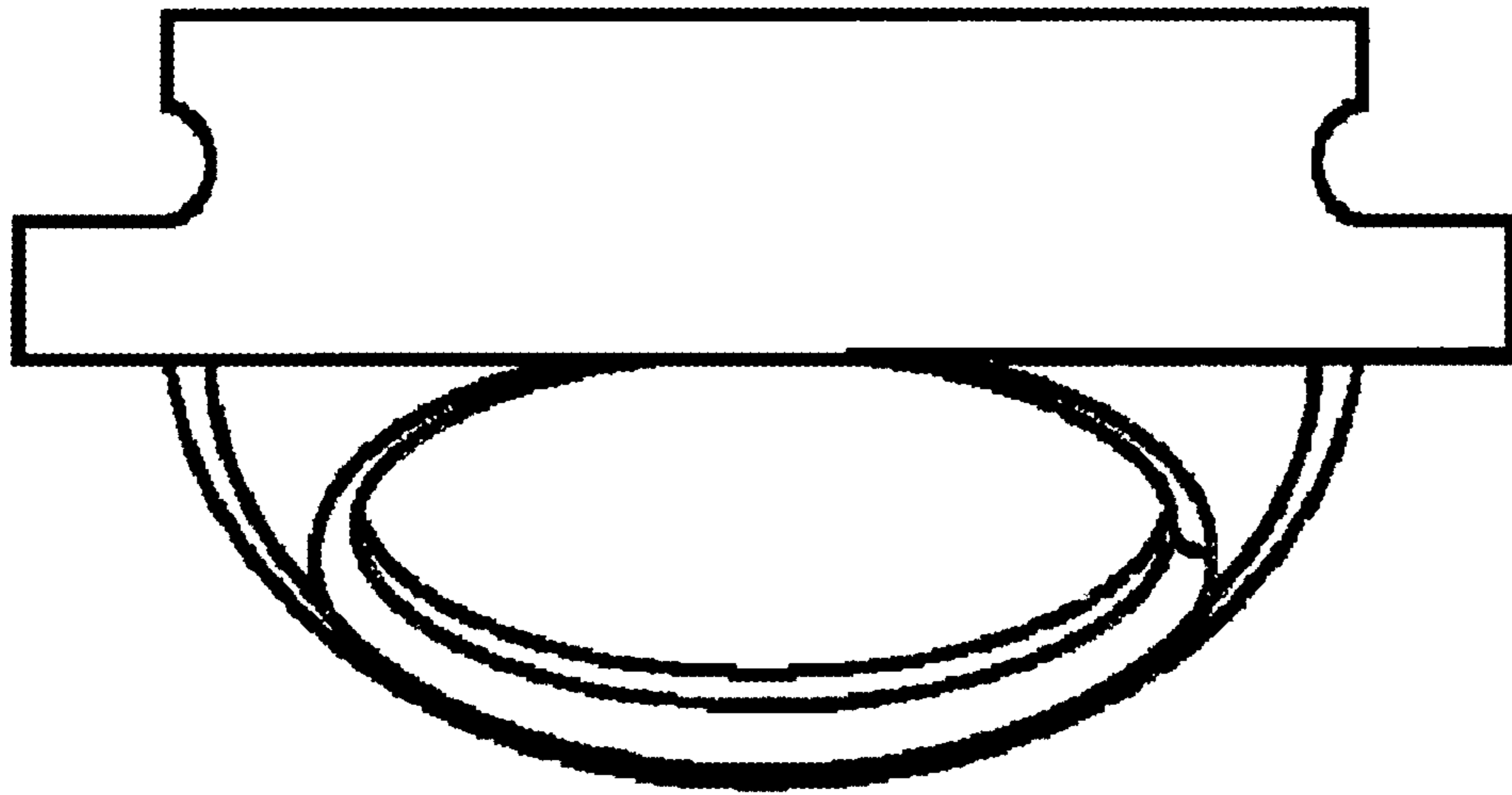

Fig. 6

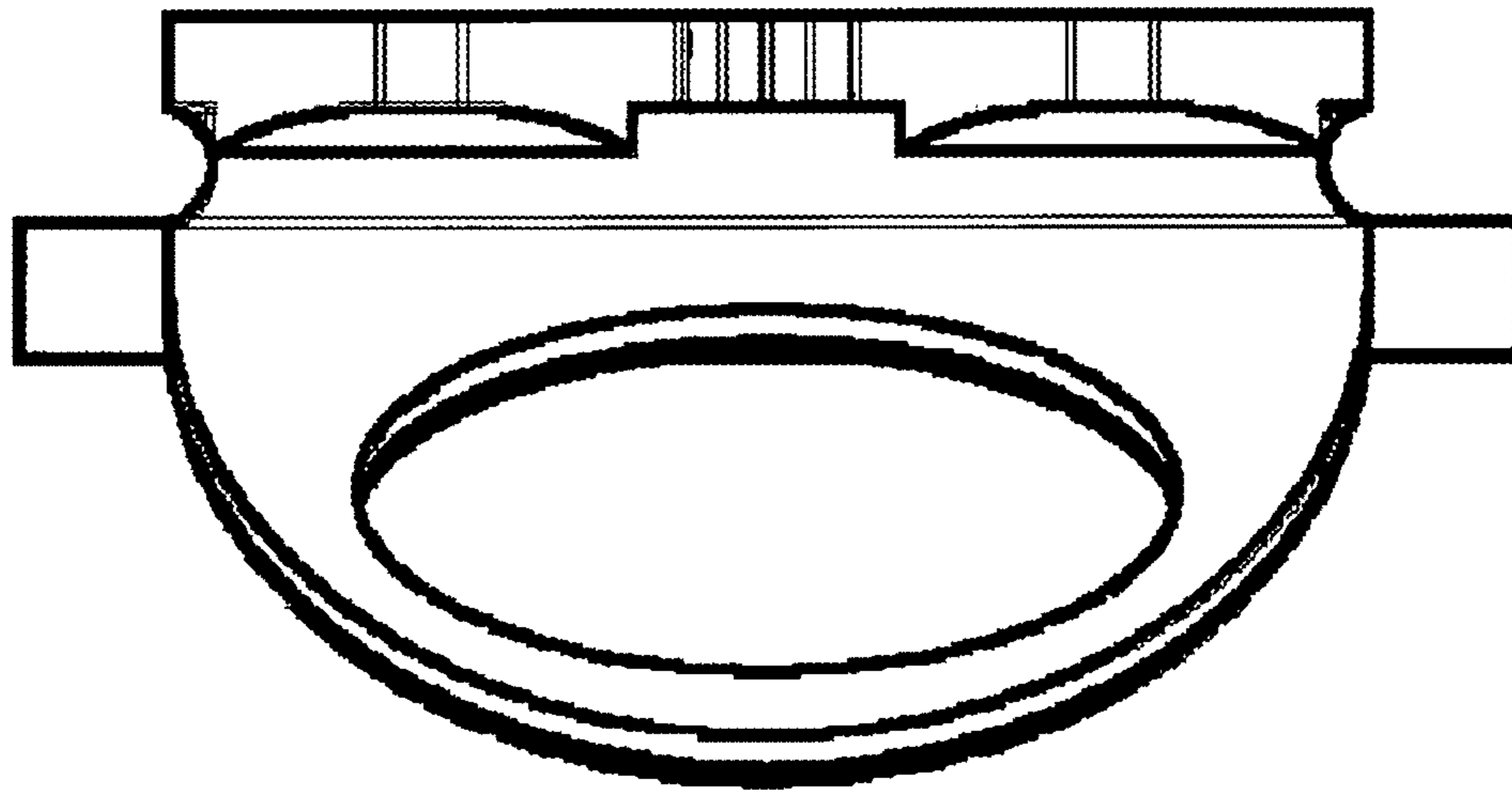

Fig. 7

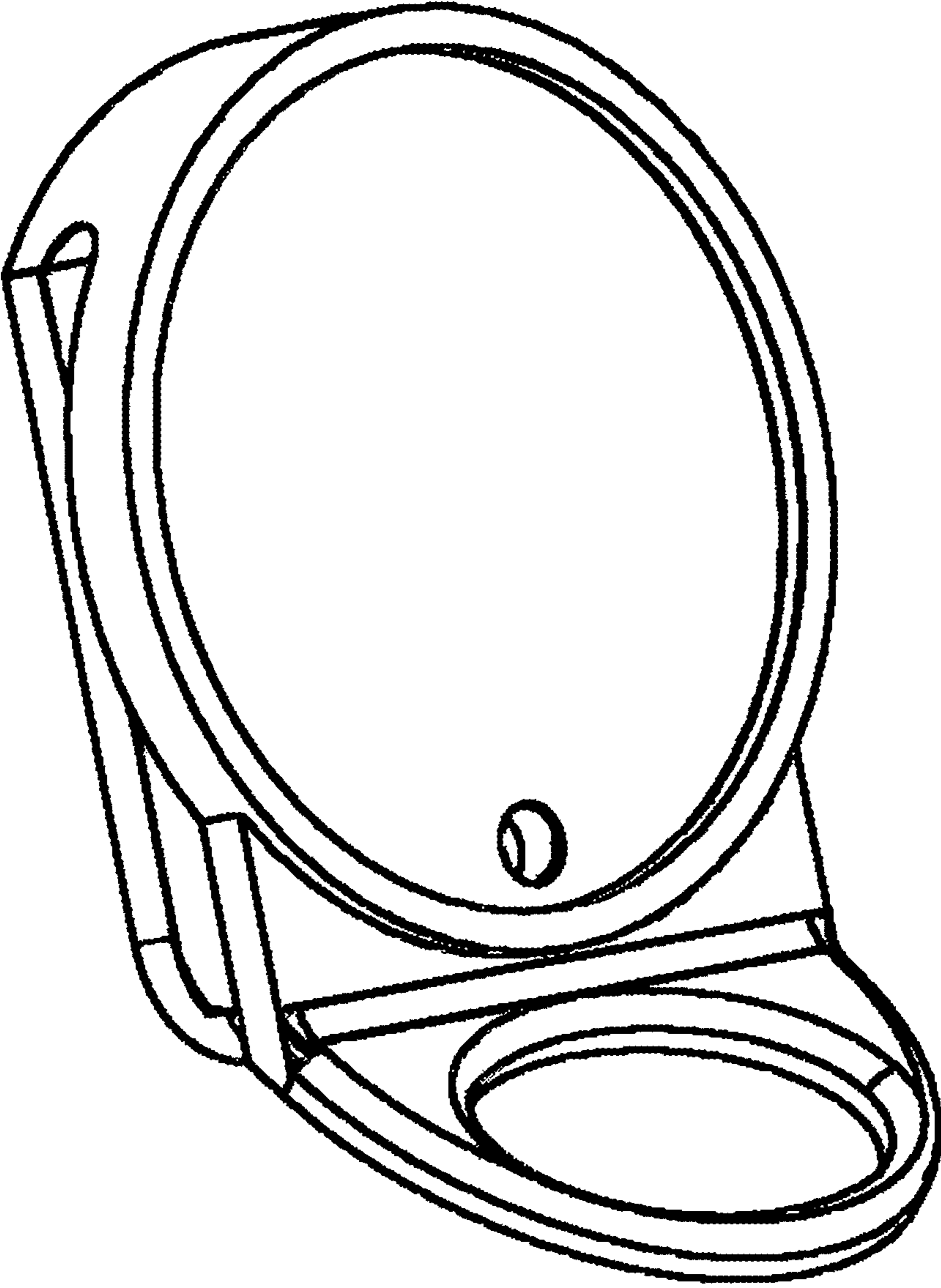

Fig. 8

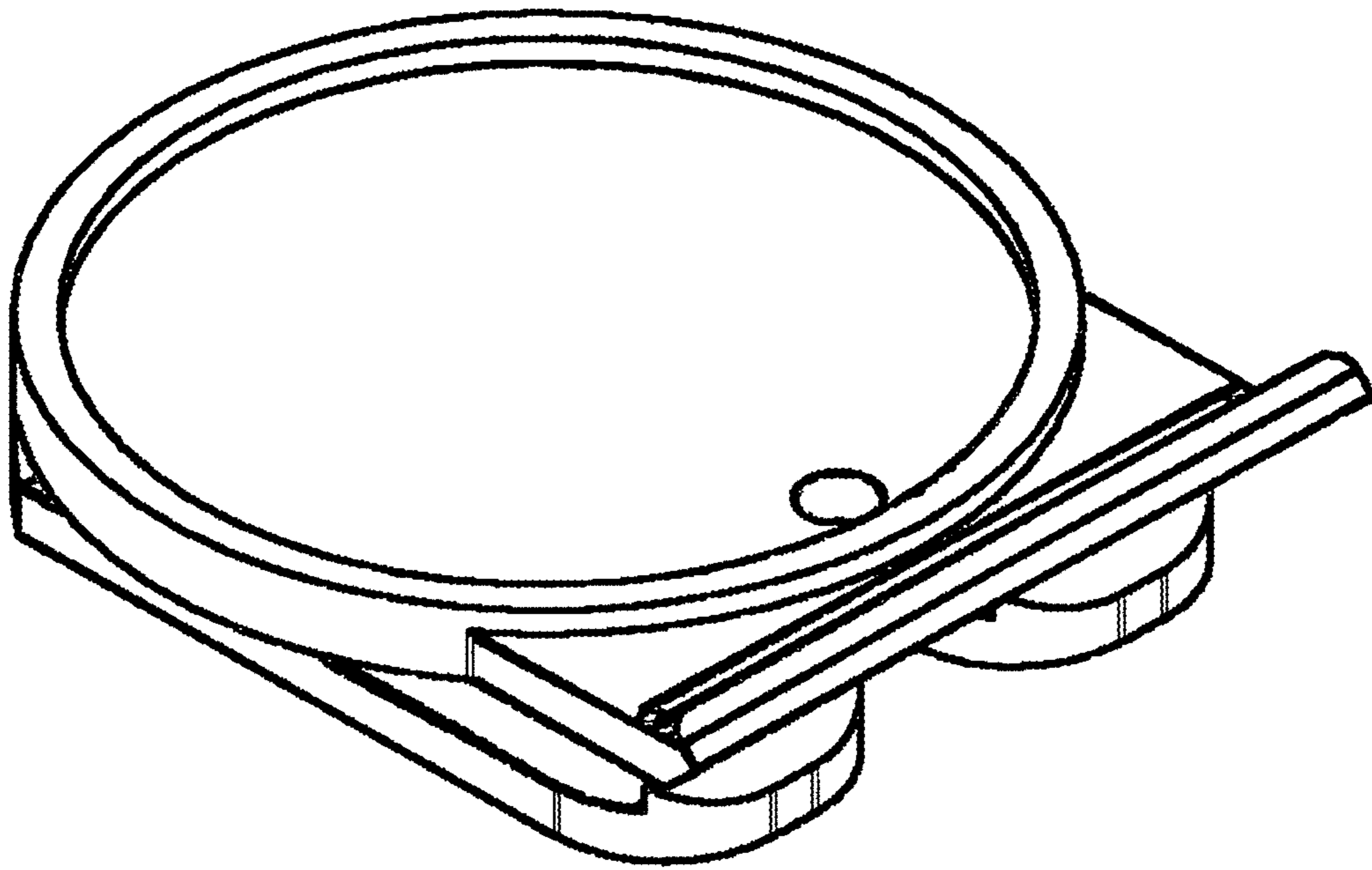

Fig. 9

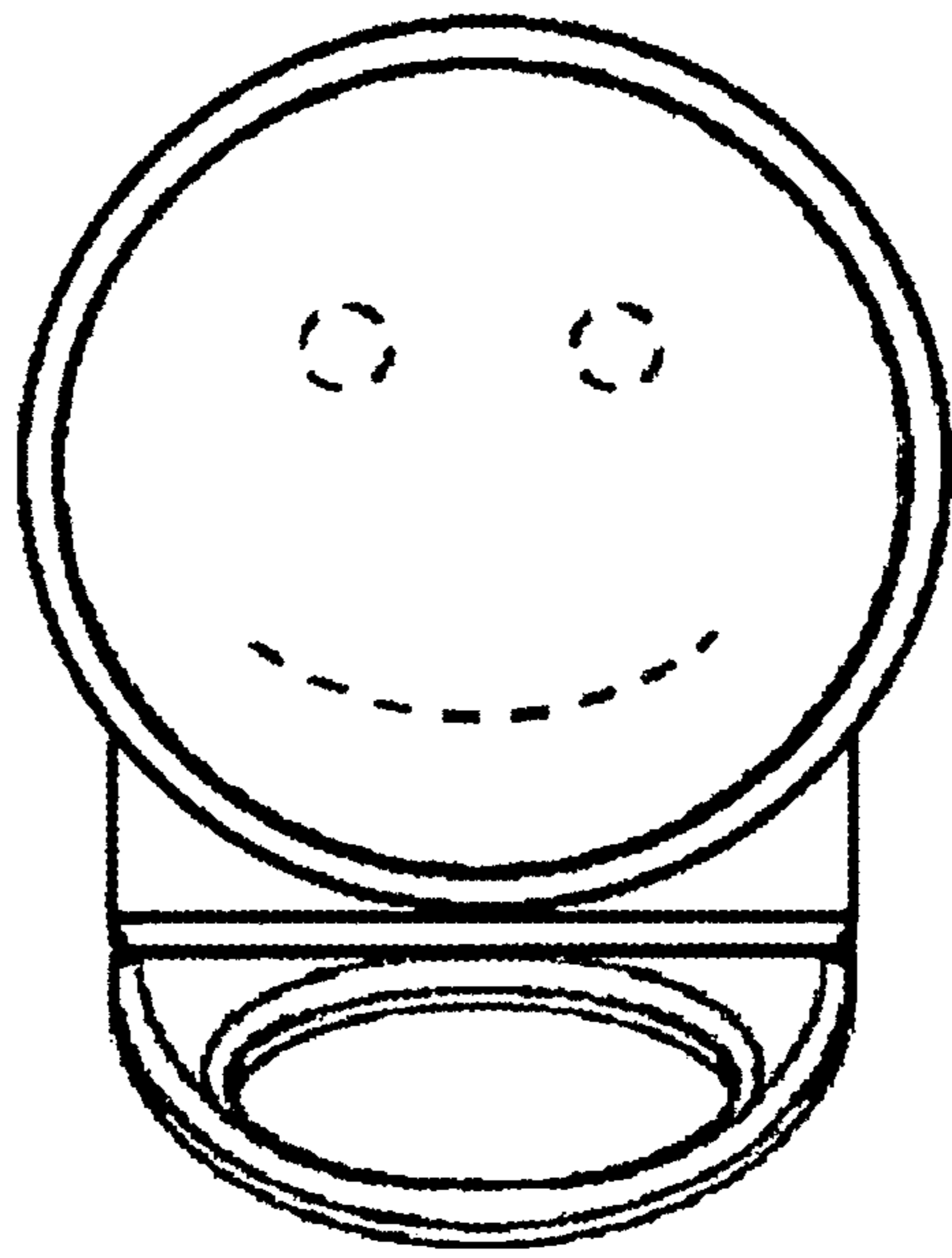

Fig. 10

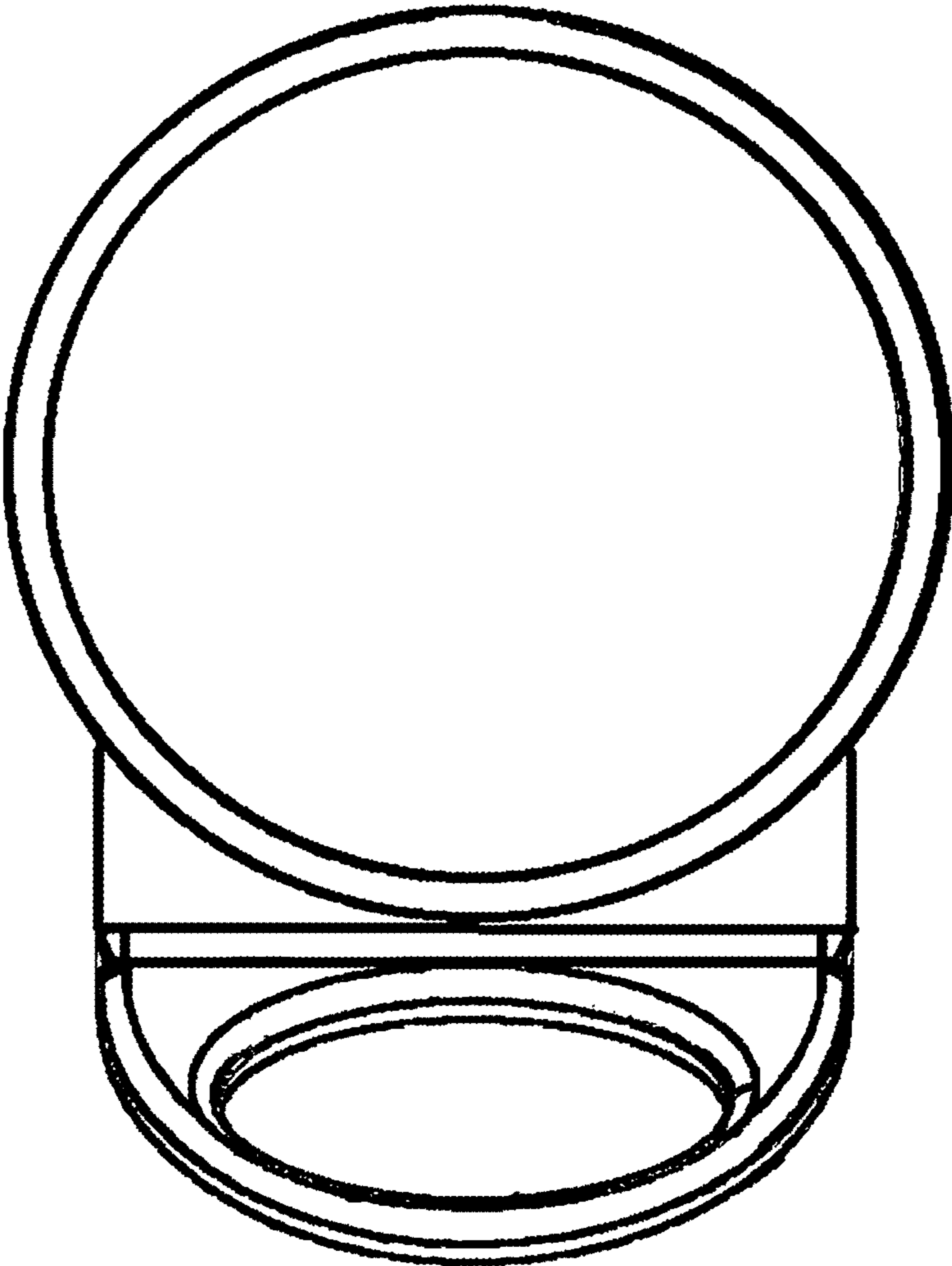

Fig. 11

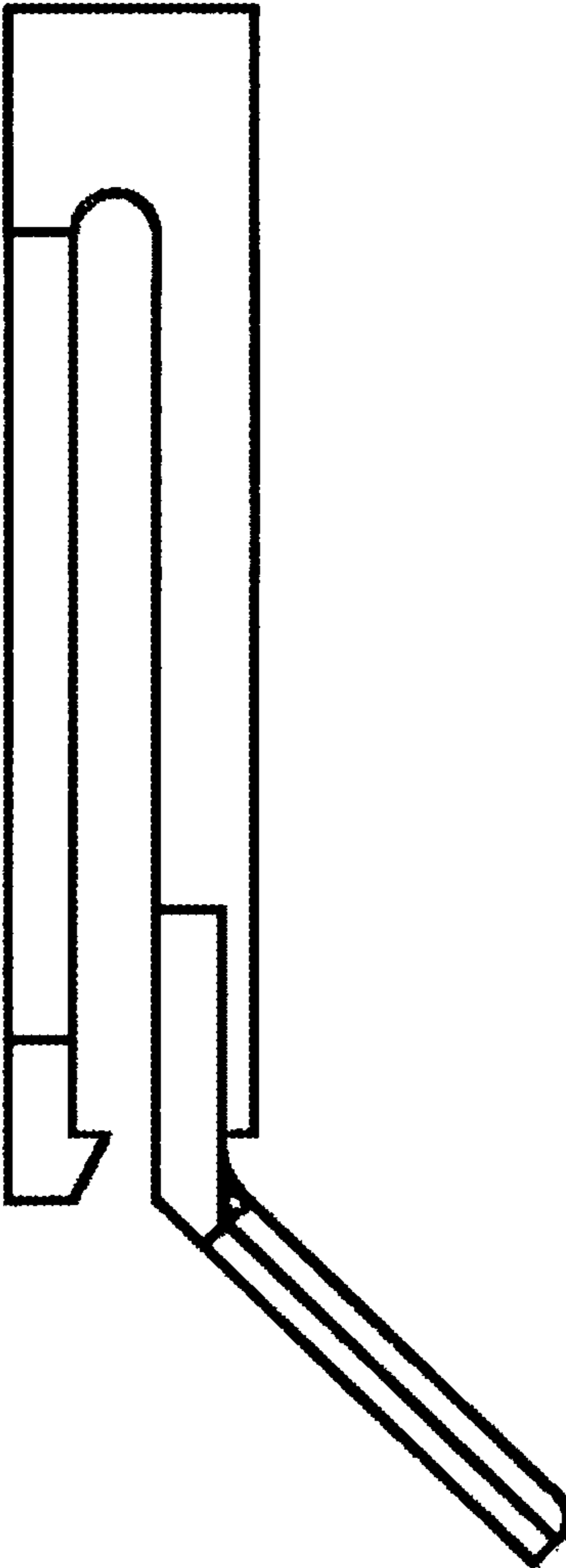

Fig. 12

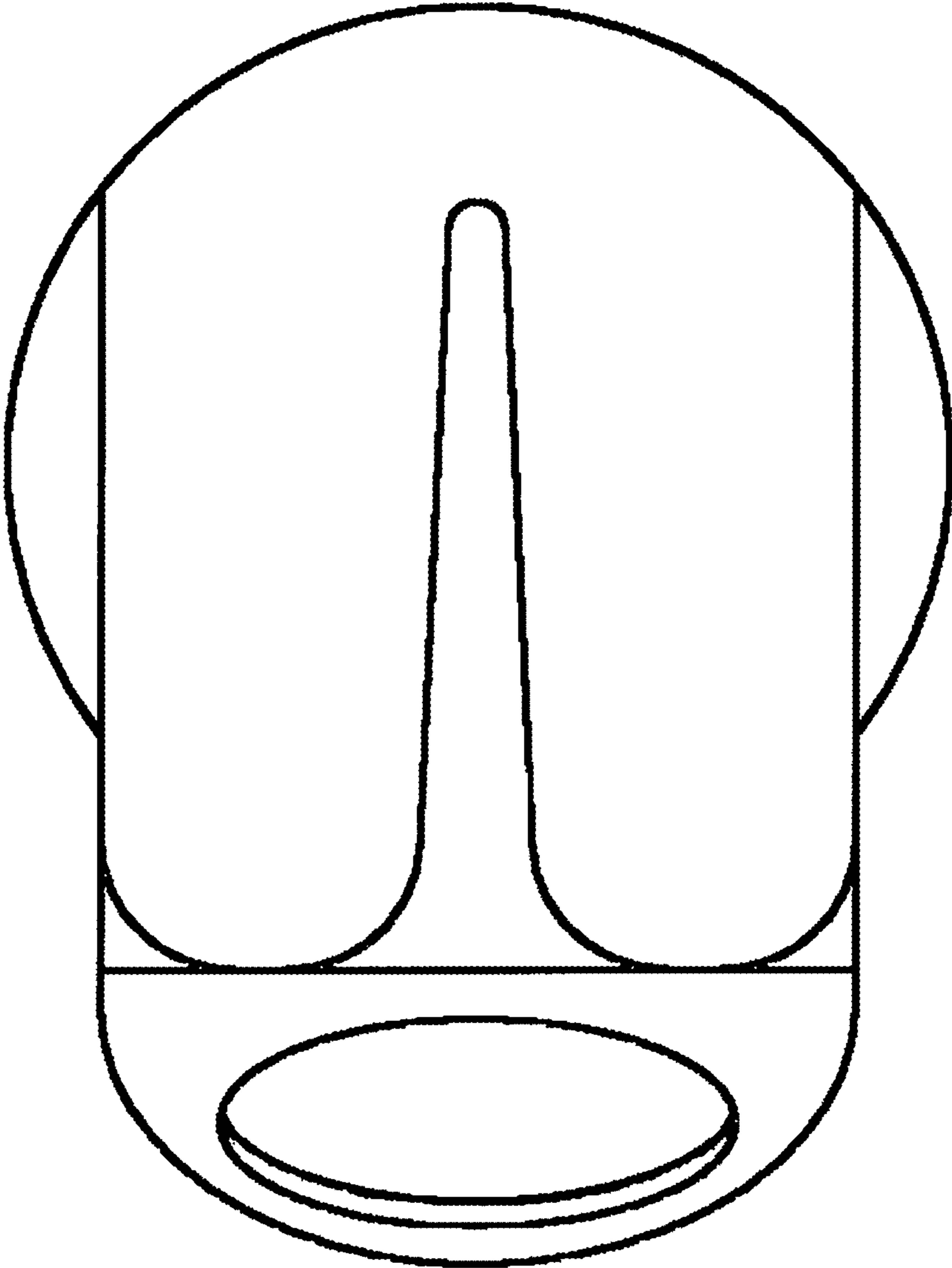

Fig. 13

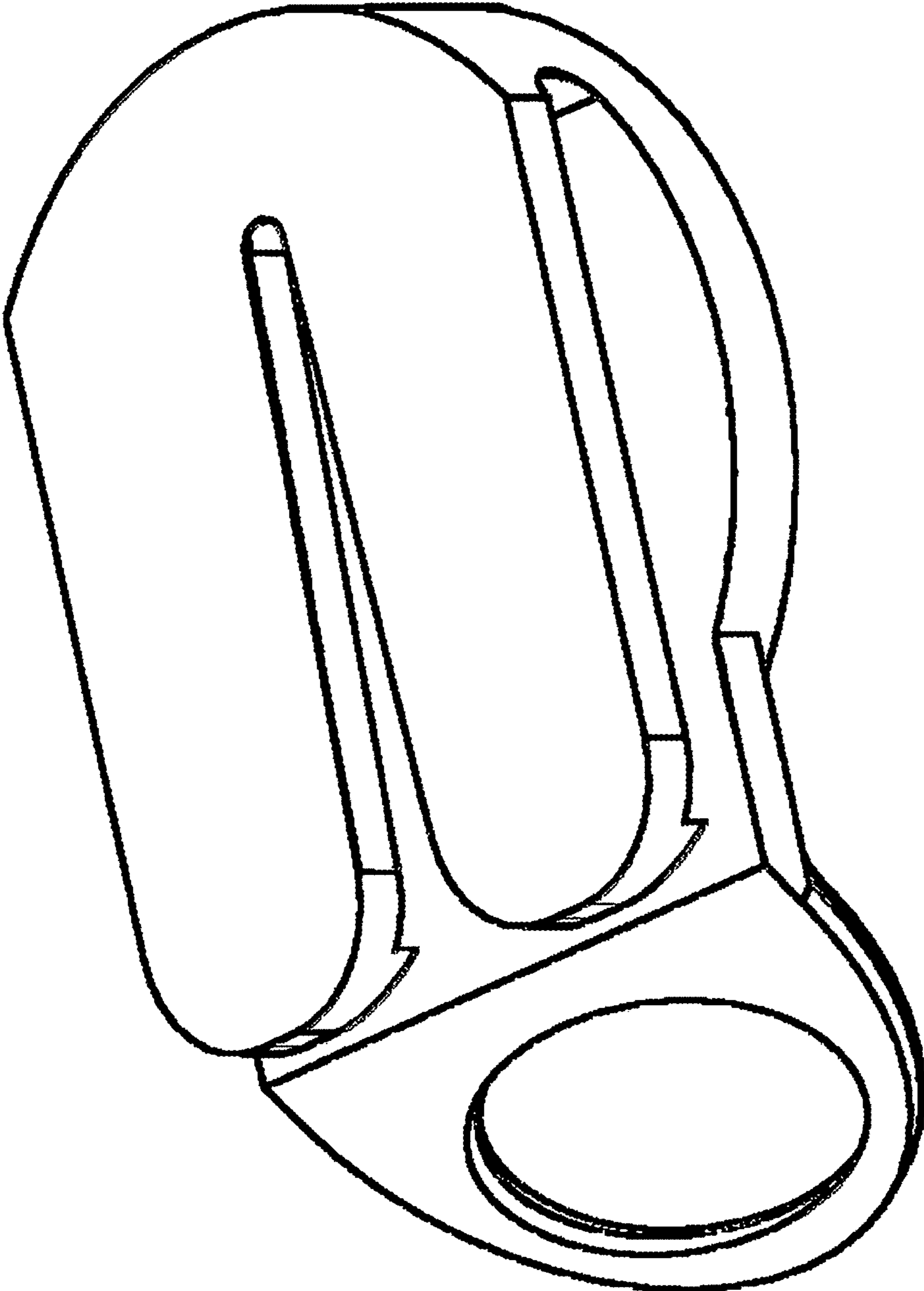

Fig. 14

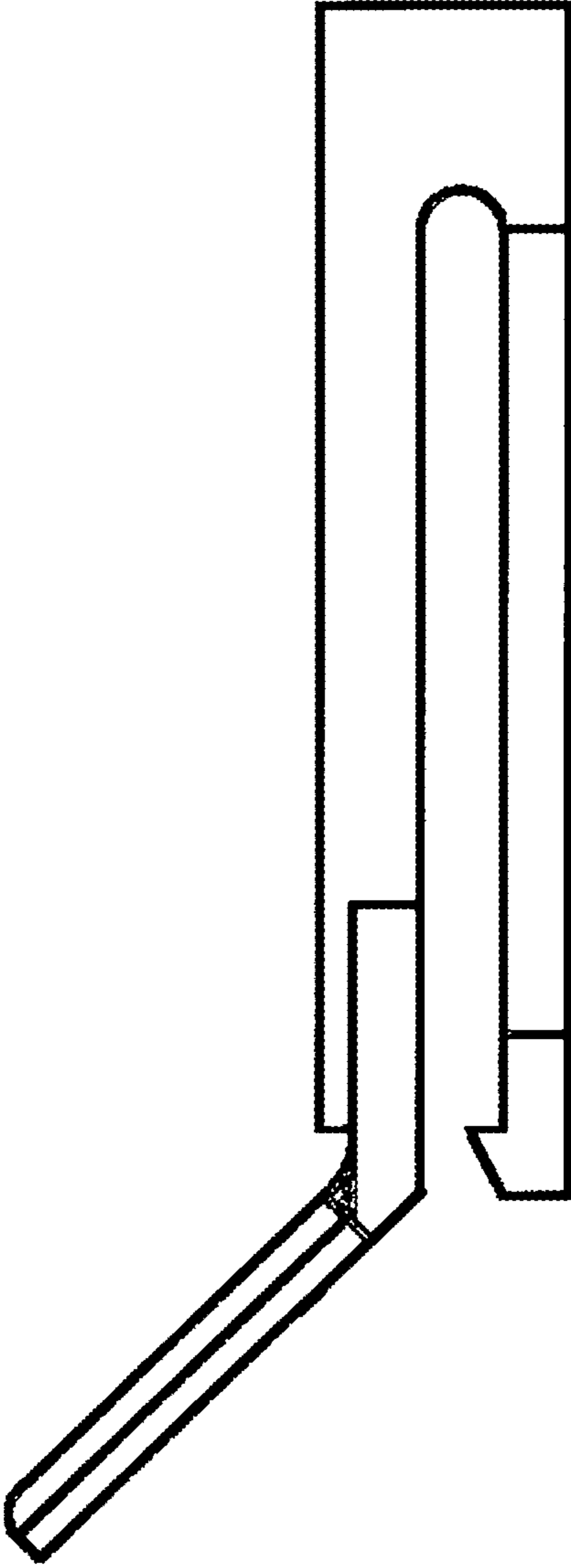

Fig. 15

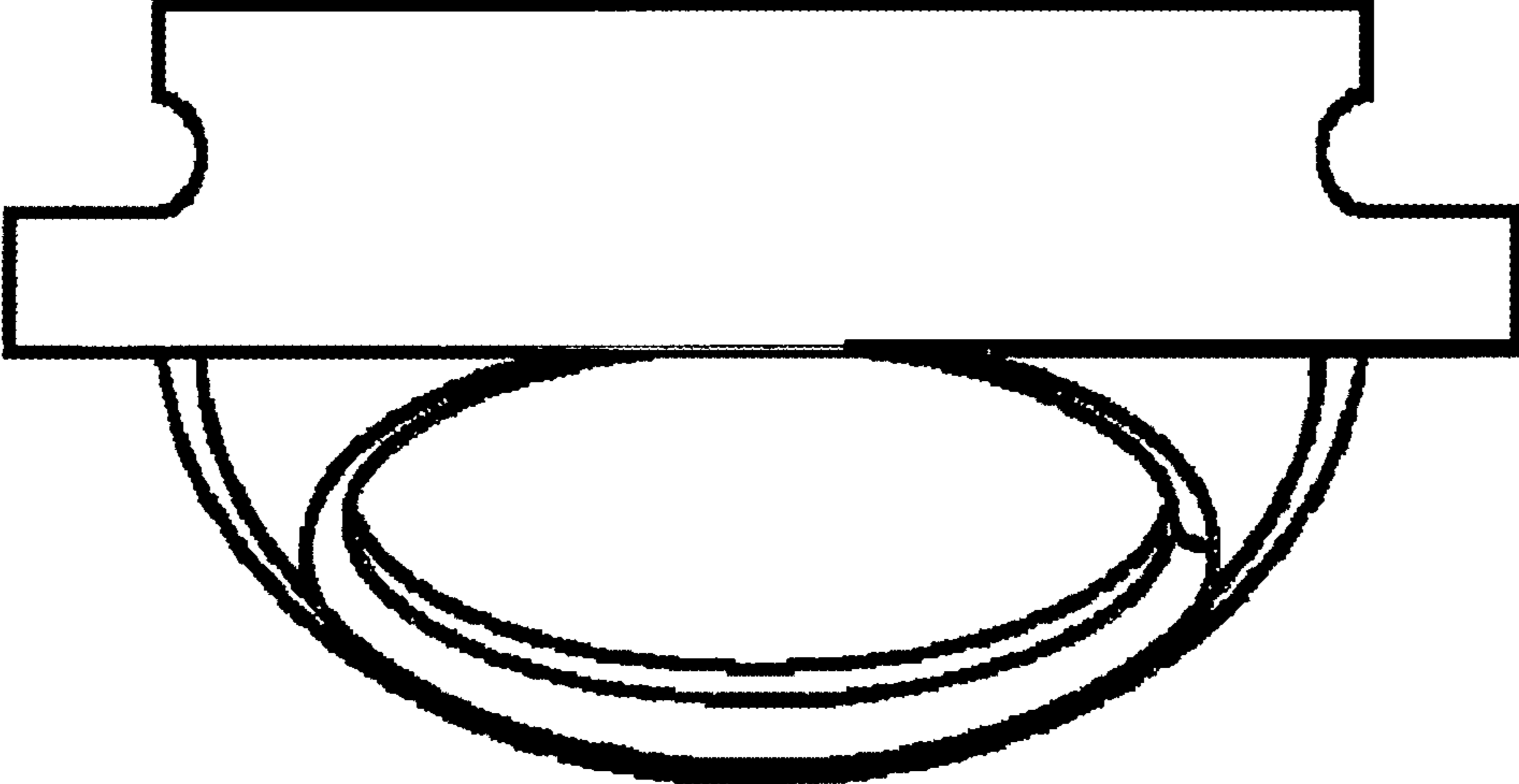

Fig. 16

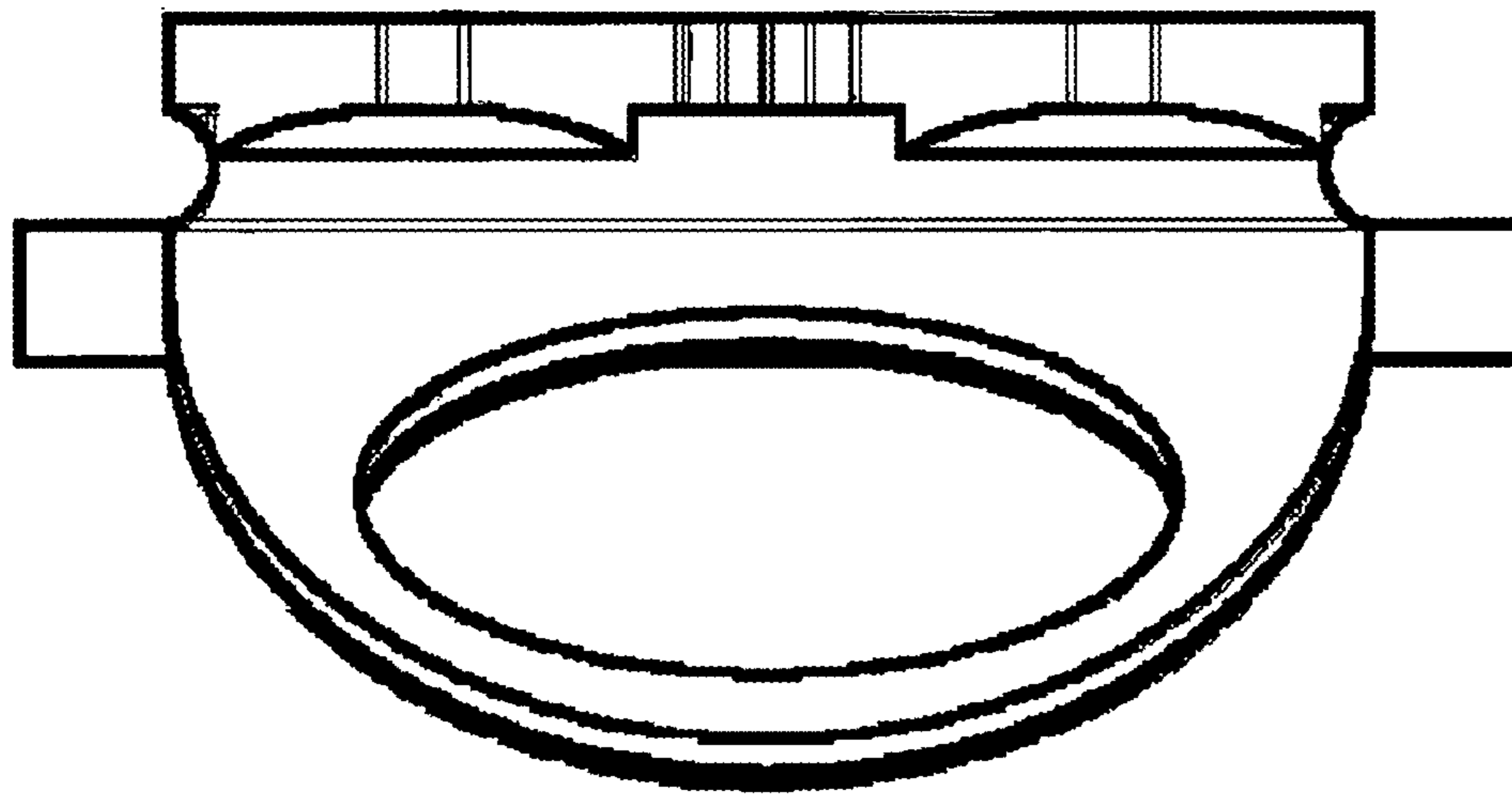

Fig. 17

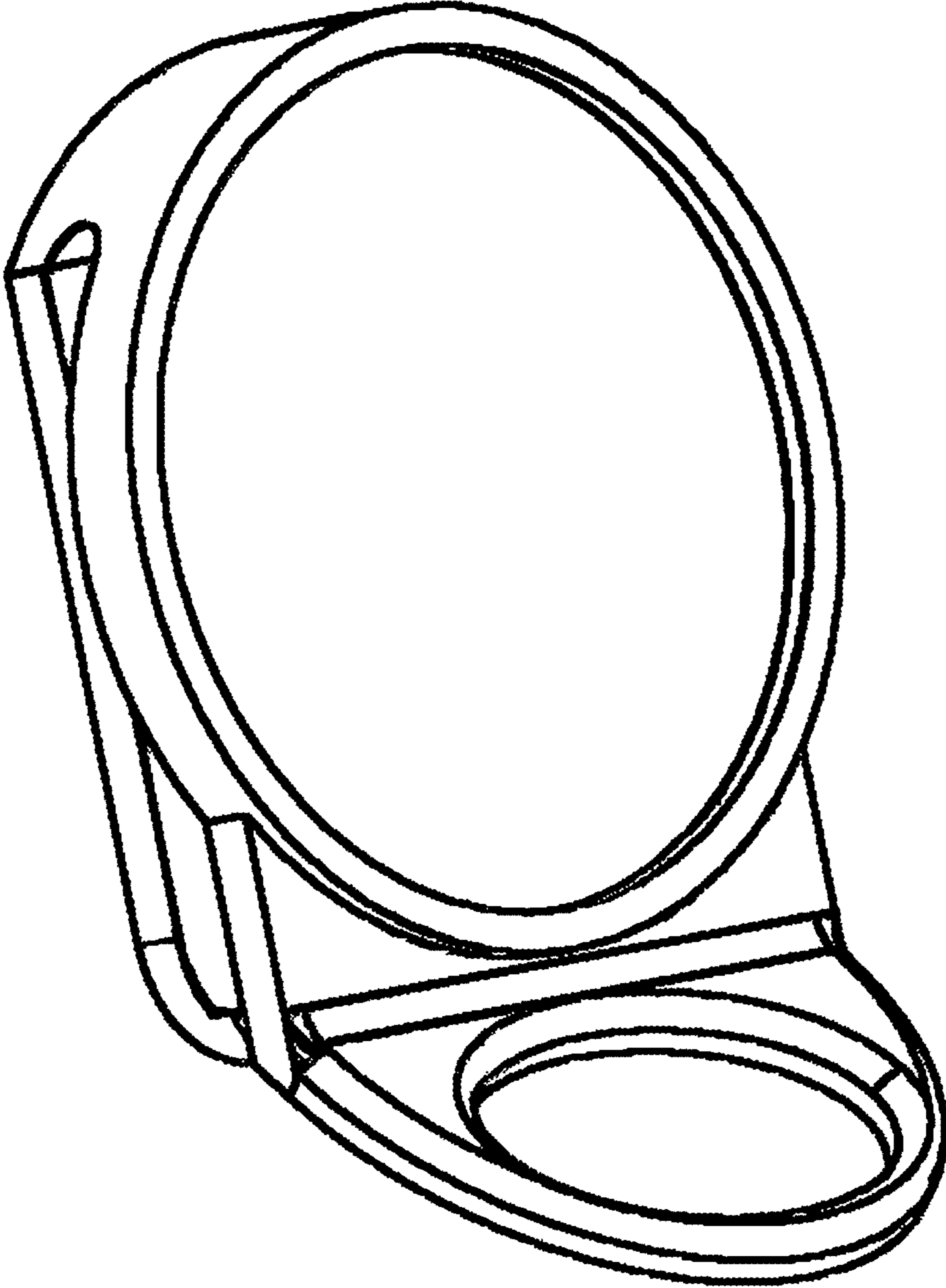

Fig. 18

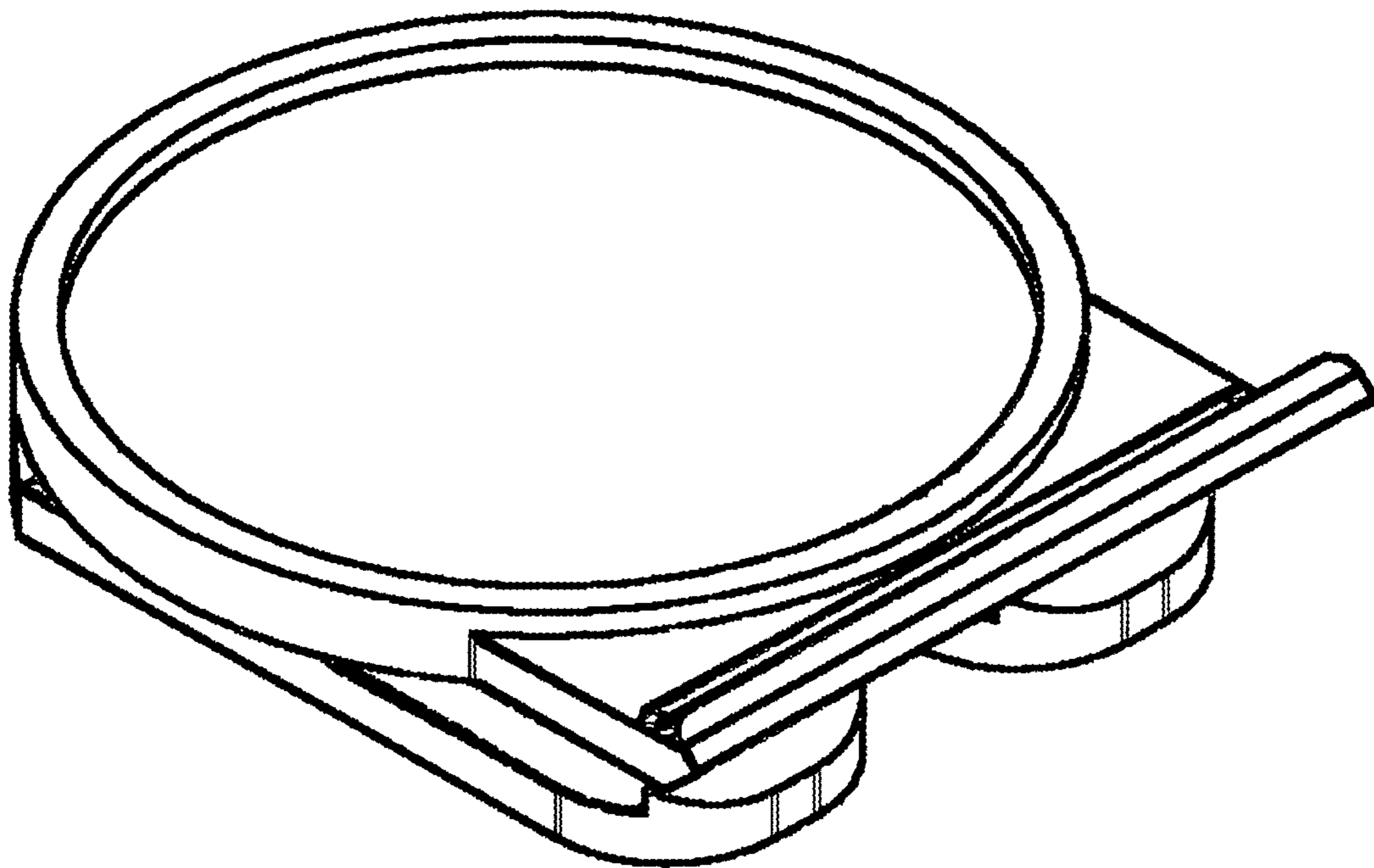

Fig. 19

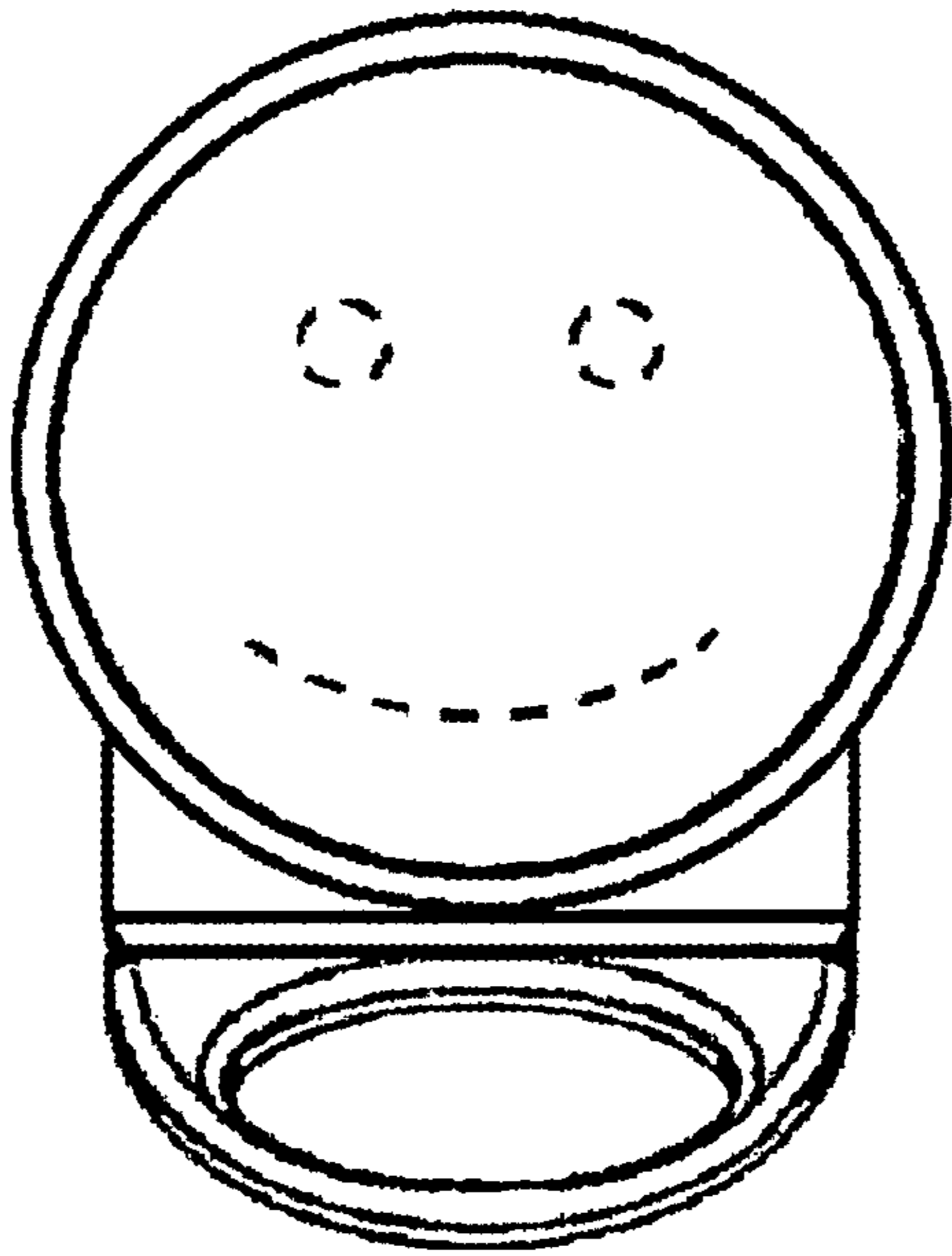

Fig. 20