



US00D911022S

(12) **United States Design Patent** (10) **Patent No.:** **US D911,022 S**
Choi et al. (45) **Date of Patent:** **** Feb. 23, 2021**

(54) **CASE FOR EARPHONE**
(71) Applicant: **SPIGEN KOREA CO., LTD.**, Seoul (KR)

D854,832 S 7/2019 Marin
D865,662 S 11/2019 Ito
D897,095 S * 9/2020 Li D3/243

(72) Inventors: **Yoo jin Choi**, Seoul (KR); **Eun Hee Koo**, Seoul (KR)
(73) Assignee: **SPIGEN KOREA CO., LTD.**, Seoul (KR)

OTHER PUBLICATIONS

Amazon, "Cyrill [Mini Bag Classic Leather Collection] Designed for Apple AirPods Pro Case / AirPods Pro Case Cover (2019)—Black", First on sale Jan. 11, 2020. (<https://www.amazon.com/dp/B083QTSQ8S>) (Year: 2020).
"Neoprene Protective Carrying Sleeve Case Bag for Apple AirPods Charging Case (PU Leather Black)", <https://www.amazon.com/Neoprene-Protective-Carrying-AirPods-Charging/dp/B071YB7TMN>, Earliest review date of Mar. 13, 2017, downloaded Jun. 25, 2020.

(**) Term: **15 Years**
(21) Appl. No.: **29/716,365**

(Continued)

(22) Filed: **Dec. 9, 2019**
(51) **LOC (13) Cl.** **03-01**
(52) **U.S. Cl.**
USPC **D3/208; D3/299**
(58) **Field of Classification Search**
USPC D3/208, 212, 290, 243, 299
CPC H04R 1/1025
See application file for complete search history.

Primary Examiner — April Rivas
(74) *Attorney, Agent, or Firm* — Heedong Chae; Lucem, PC

(57) **CLAIM**
The ornamental design for a case for earphone, as shown and described.

(56) **References Cited**
U.S. PATENT DOCUMENTS
D321,981 S * 12/1991 Hanke D3/267
D544,707 S * 6/2007 Labelson D3/208
D548,972 S * 8/2007 Wald D12/415
D609,457 S * 2/2010 Blanford D3/208
D620,258 S * 7/2010 Fahrendorff D3/299
D621,605 S * 8/2010 MacDonald D3/212
D680,733 S * 4/2013 Aprea D3/208
D756,105 S 5/2016 Zhang
D773,176 S 12/2016 Boyd et al.
D782,816 S 4/2017 Boyd et al.
D819,960 S 6/2018 Zhang
D833,145 S * 11/2018 Lousse D3/290
D836,327 S 12/2018 Nye
D851,394 S 6/2019 Li

DESCRIPTION

FIG. 1 is a front perspective view of a case for earphone showing my new design;
FIG. 2 is a rear perspective view thereof;
FIG. 3 is a front elevational view thereof;
FIG. 4 is a rear elevational view thereof;
FIG. 5 is a left side elevational view thereof;
FIG. 6 is a right side elevational view thereof;
FIG. 7 is a top plan view thereof; and,
FIG. 8 is a bottom plan view thereof.
The broken lines throughout the drawing figures depict portions of the case for earphone that form no part of the claimed design.

1 Claim, 8 Drawing Sheets

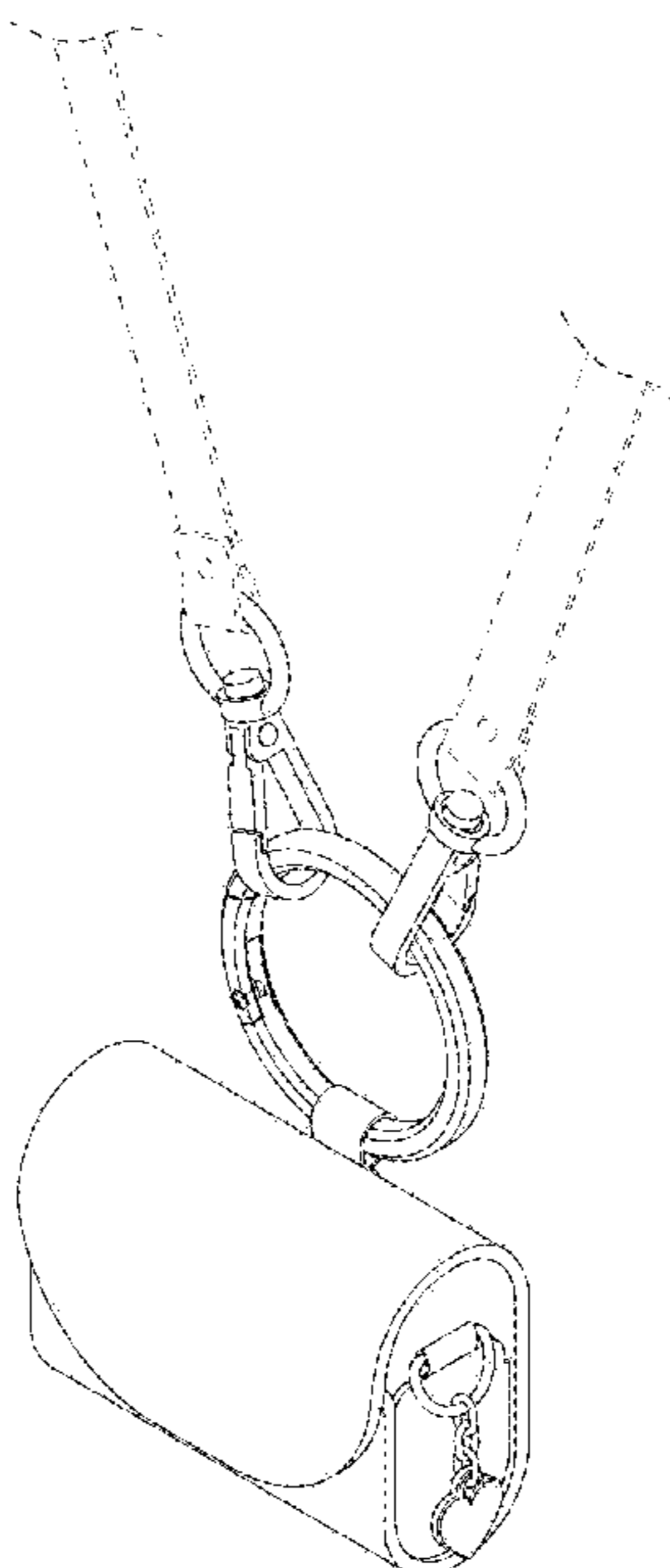

(56)

References Cited

OTHER PUBLICATIONS

“Airpods Case, Thanksacase Embossed Pattern PU Leather Case 2 in 1 Combo Magnet Closure Cover for Apple AirPods and Airpods Strap.(Rose Gold)”, <https://www.amazon.com/Airpods-Thanksacase-Embossed-Pattern-Leather/dp/B06XD3H14G>, Earliest review date of Apr. 5, 2017, downloaded Jun. 25, 2020.

“Fintie Case for AirPods, Premium PU Leather Magnet Closure Protective Portable Cover Skin with Metal Clasp and Keychain for AirPods 1 and AirPods 2 Charging Case, Brown”, <https://www.amazon.com/Fintie-Protective-Portable-Keychain-Charging/dp/B07235R3B8>, Earliest review date of Jul. 5, 2017, downloaded Jun. 25, 2020.

“MoKo AirPods Case, Magnetic Snap Closure Protective Cover Carrying Pouch Pocket, with Holding Strap, Leather Protective Cover Shell Skin Storage for AirPods 1 Charging Case—Black”,

<https://www.amazon.com/MoKo-AirPods-Protective-Carrying-Charging/dp/B06Y2VD7GL>, Earliest review date of Aug. 21, 2017, downloaded Jun. 25, 2020.

“Fintie Case for AirPods, Premium PU Leather Magnet Closure Protective Portable Cover Skin with Metal Clasp and Keychain for AirPods 1 and AirPods 2 Charging Case, Colorful Mosaic”, <https://www.amazon.com/dp/B0728CDKXM>, Earliest review date of Sep. 25, 2017, downloaded Jun. 25, 2020.

“Elago Leather AirPods Case Designed for Apple AirPods 1 & 2 [Black]”, <https://www.amazon.com/elago-AirPods-Leather-Case-Black/dp/B073GMLCB4>, Earliest review date of Mar. 23, 2018, downloaded Jun. 25, 2020.

“Spaysi Airpods Leather Case Genuine Leather Airpods Case with Metal Clasp Strap for Belt and Bag Airpods Carrying Case Protective Cover for Apple Airpods Accessories Charging Case (Black)”, <https://www.amazon.com/Spaysi-Carrying-Protective-Accessories-Charging/dp/B07B8TB382>, Earliest review date of Apr. 30, 2018, downloaded Jun. 25, 2020.

* cited by examiner

FIG. 1

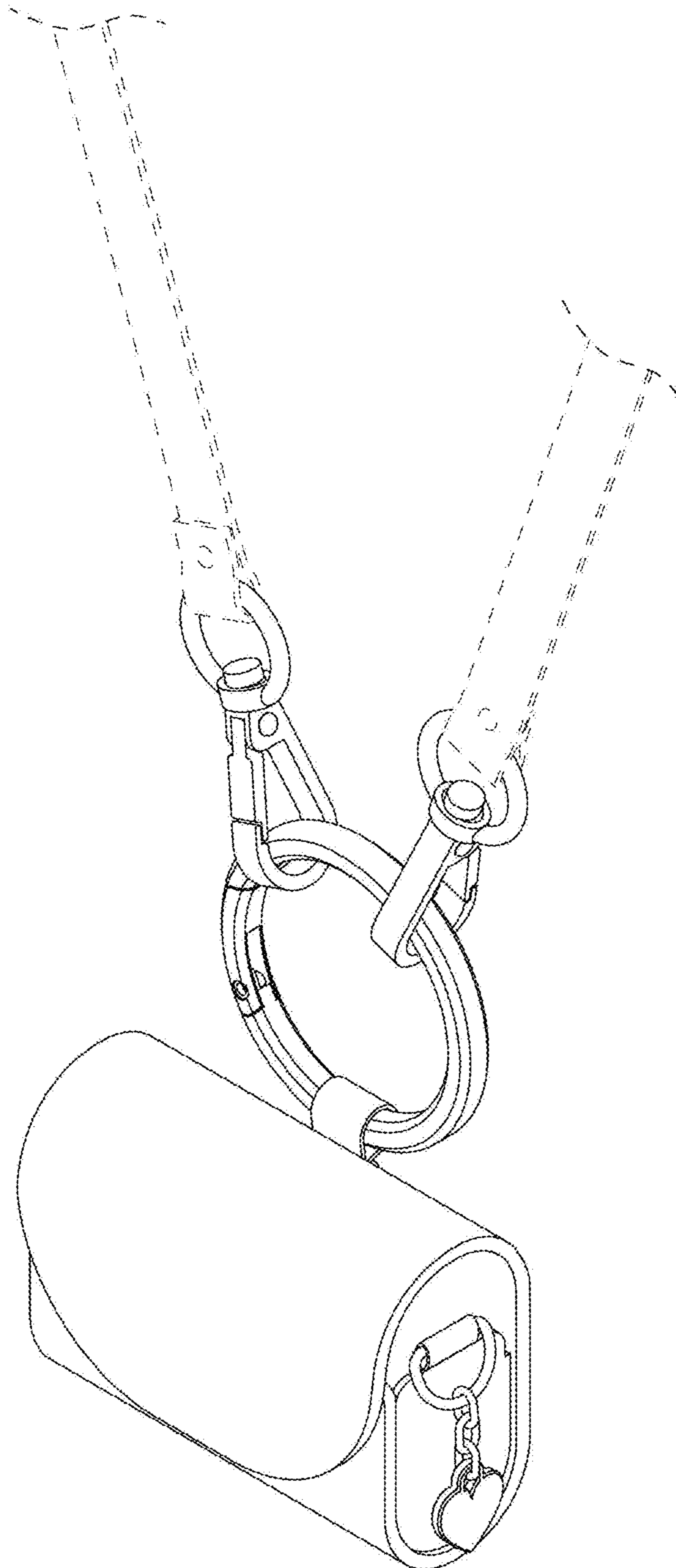

FIG. 2

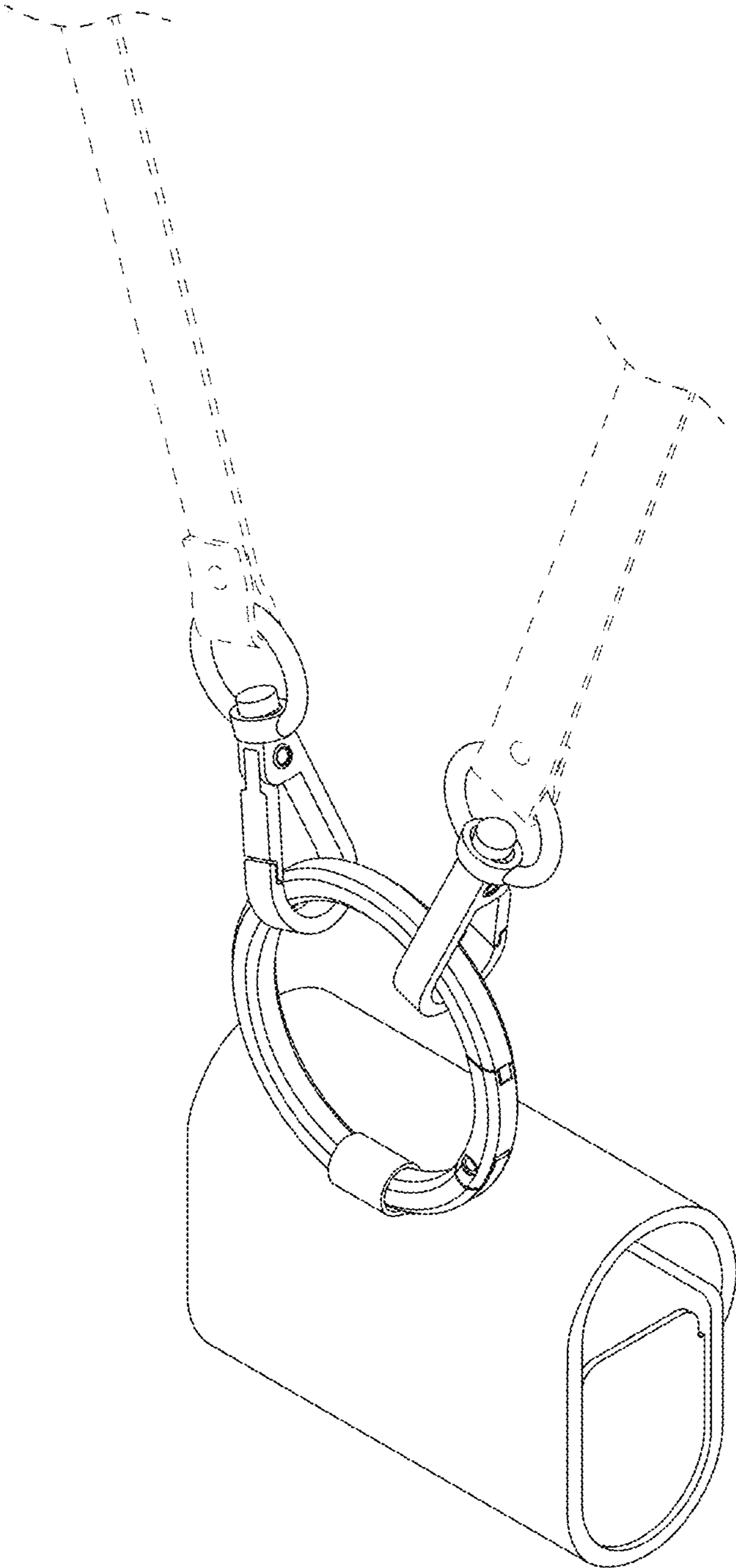

FIG. 3

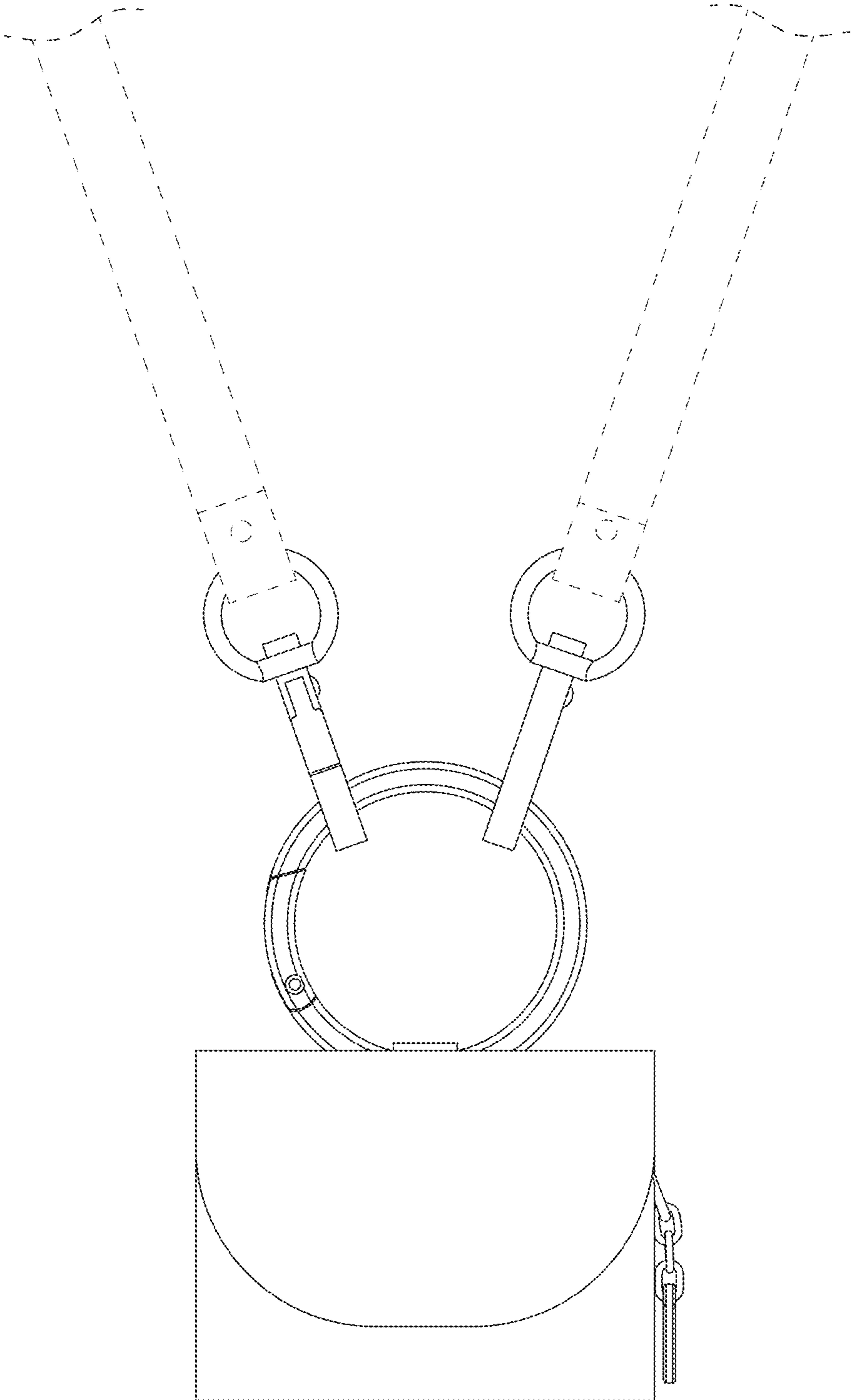

FIG. 4

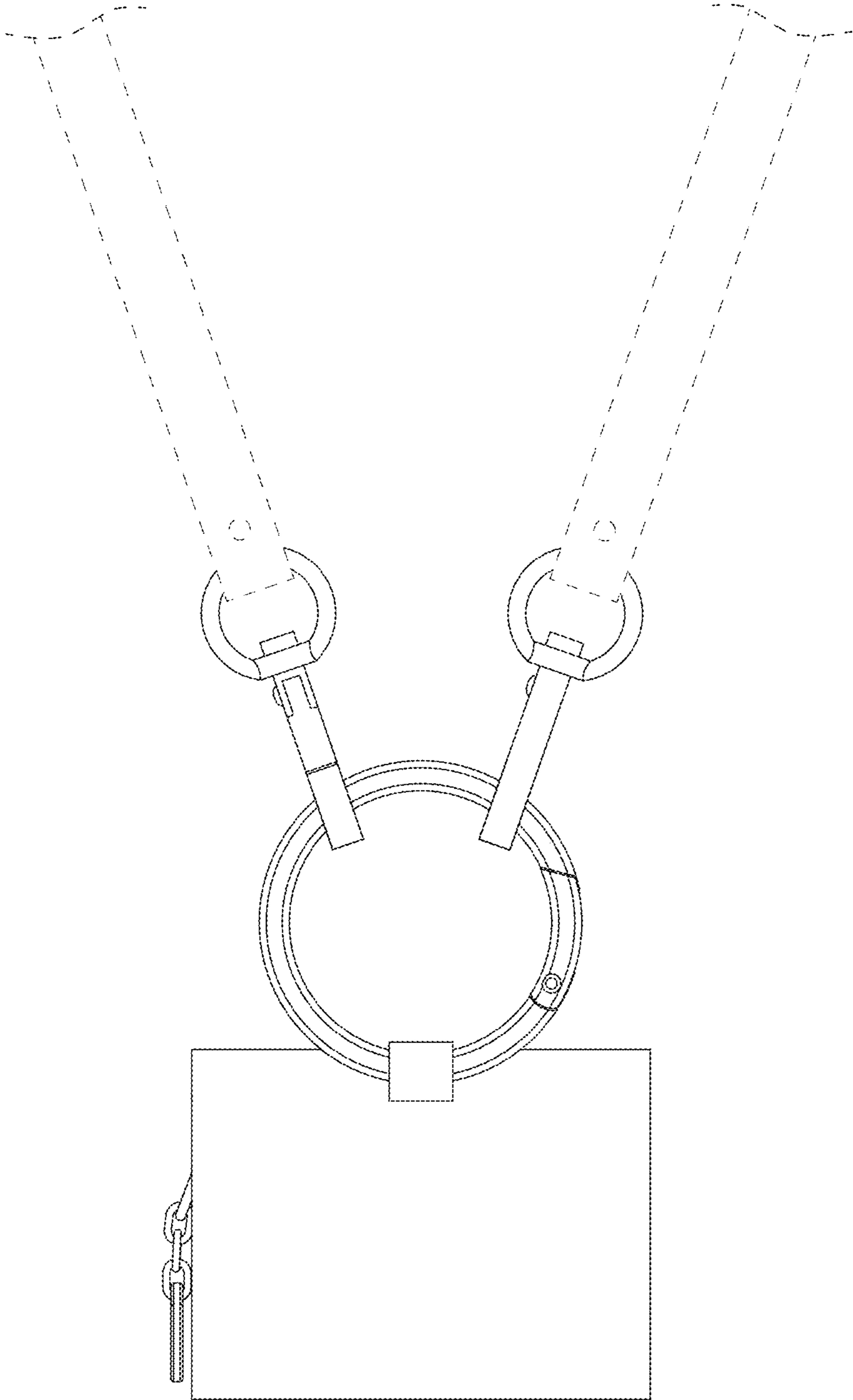

FIG. 5

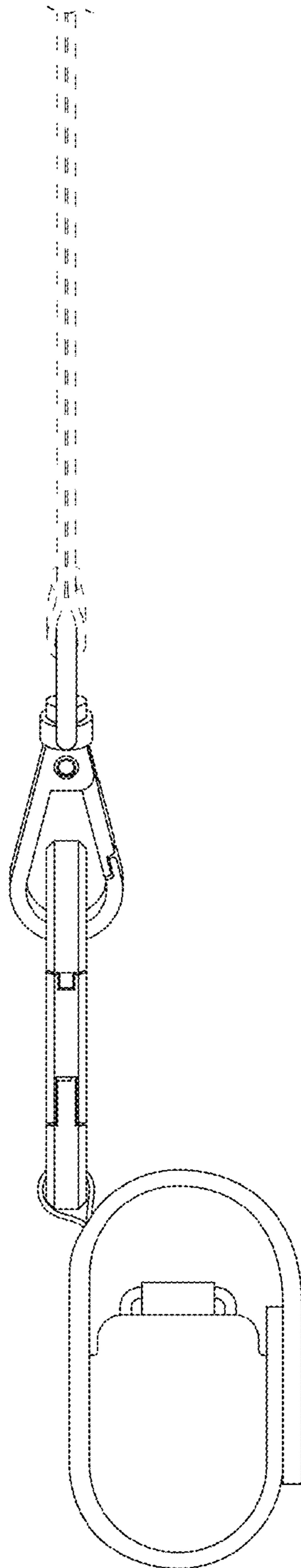

FIG. 6

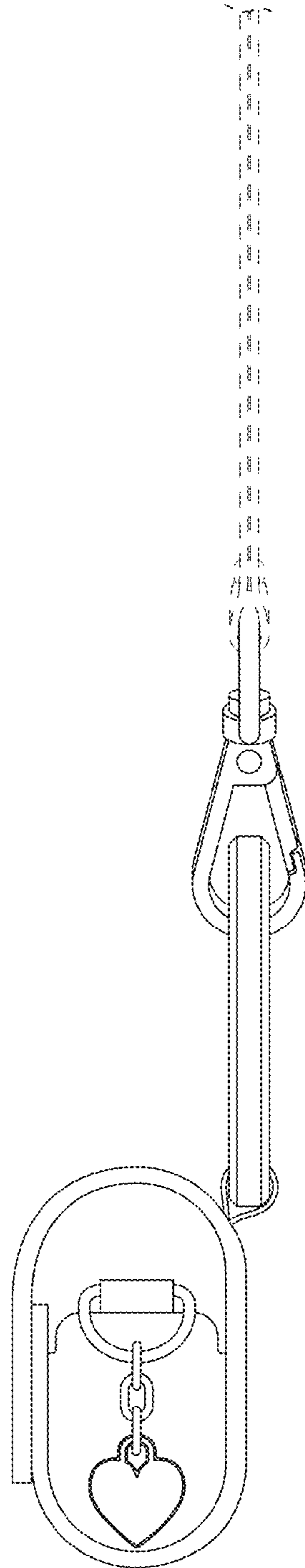

FIG. 7

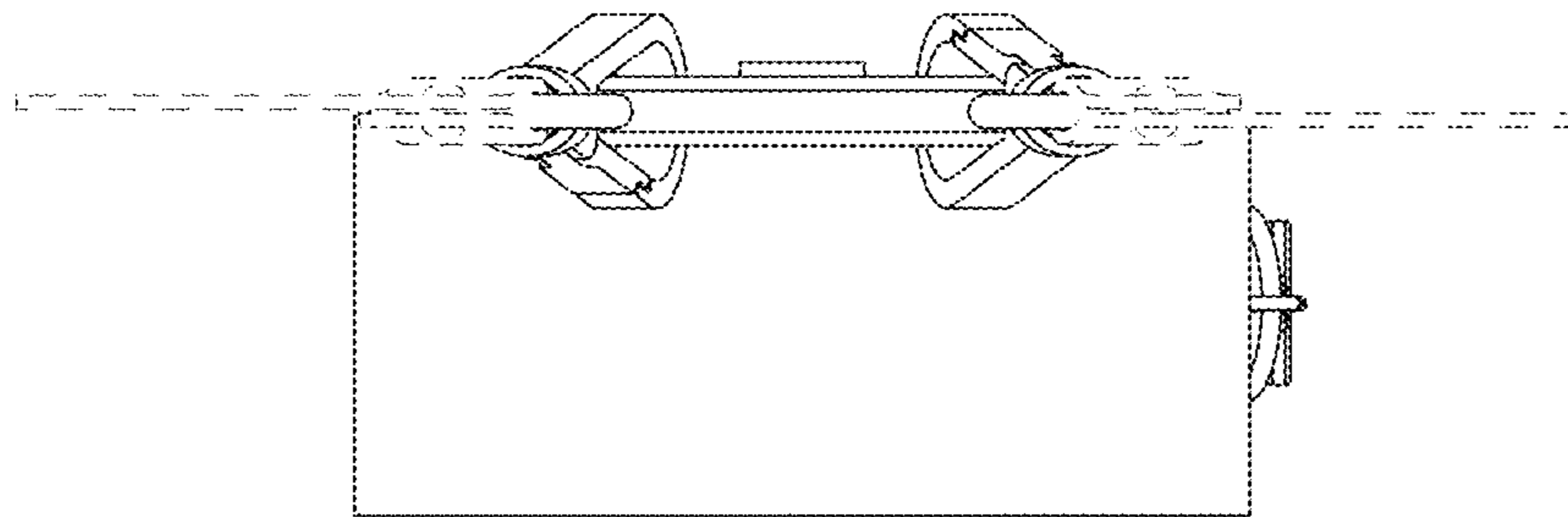

FIG. 8

