



US00D910973S

(12) **United States Design Patent** (10) **Patent No.:** **US D910,973 S**
Crow et al. (45) **Date of Patent:** **** Feb. 23, 2021**

(54) **THREE DIMENSIONAL COLLAR**
(71) Applicant: **Blackbird Consulting, LLC**, Franklin, TN (US)
(72) Inventors: **Philip Crow**, Franklin, TN (US); **Charles Hiser**, Greensboro, NC (US)
(73) Assignee: **Blackbird Consulting, LLC**, Franklin, TN (US)
(**) Term: **15 Years**
(21) Appl. No.: **29/719,816**
(22) Filed: **Jan. 8, 2020**
(51) **LOC (13) Cl.** **02-05**
(52) **U.S. Cl.**
USPC **D2/602**
(58) **Field of Classification Search**
USPC D2/500, 501, 502, 503, 504, 505, 506, D2/507, 508, 600, 601, 602, 603, 604, D2/605, 606, 607, 608, 609; D30/152
CPC .. A41D 23/00; A41D 2023/004; A41D 25/00; A41D 25/001; A41D 25/003; A41D 25/005; A41D 25/02; A41D 25/04; A41D 25/06; A41D 25/08; A41D 25/10
See application file for complete search history.

(56) **References Cited**
U.S. PATENT DOCUMENTS
D3,557 S * 6/1869 Brown D2/602
D103,609 S * 3/1937 Dietz D2/602
2,125,715 A * 8/1938 Goldenberg A41D 25/06
2/155
D113,092 S * 1/1939 Levin D2/602

2,208,026 A * 7/1940 Goldenberg A41F 1/00
24/588.12
D309,212 S * 7/1990 Maletsky D2/602
D396,539 S * 8/1998 Glennie D2/602
D421,328 S * 3/2000 Glennie D2/602
D724,816 S * 3/2015 Cristodero D2/606
9,844,237 B2 * 12/2017 Cristodero A41D 25/04
D891,708 S * 7/2020 Armstrong D30/152
2015/0216243 A1 * 8/2015 Graham A41D 25/003
2/151
2018/0317581 A1 * 11/2018 Jacks A41D 25/025

* cited by examiner
Primary Examiner — Jasmine Mlinarcik
(74) *Attorney, Agent, or Firm* — Vedder Price P.C.

(57) **CLAIM**
The ornamental design for a three dimensional collar, as shown and described.

DESCRIPTION
FIG. 1 is a front perspective view of a three dimensional collar showing our design;
FIG. 2 is a front view thereof;
FIG. 3 is a rear view thereof;
FIG. 4 is a first side view thereof;
FIG. 5 is a second side view thereof;
FIG. 6 is a top view thereof;
FIG. 7 is a bottom thereof;
FIG. 8 is another front perspective view thereof; and,
FIG. 9 is another top view thereof.
The drawings include surface shading that represents contour and not surface ornamentation. The broken lines illustrate environmental structure and form no part of the claimed design.

1 Claim, 7 Drawing Sheets

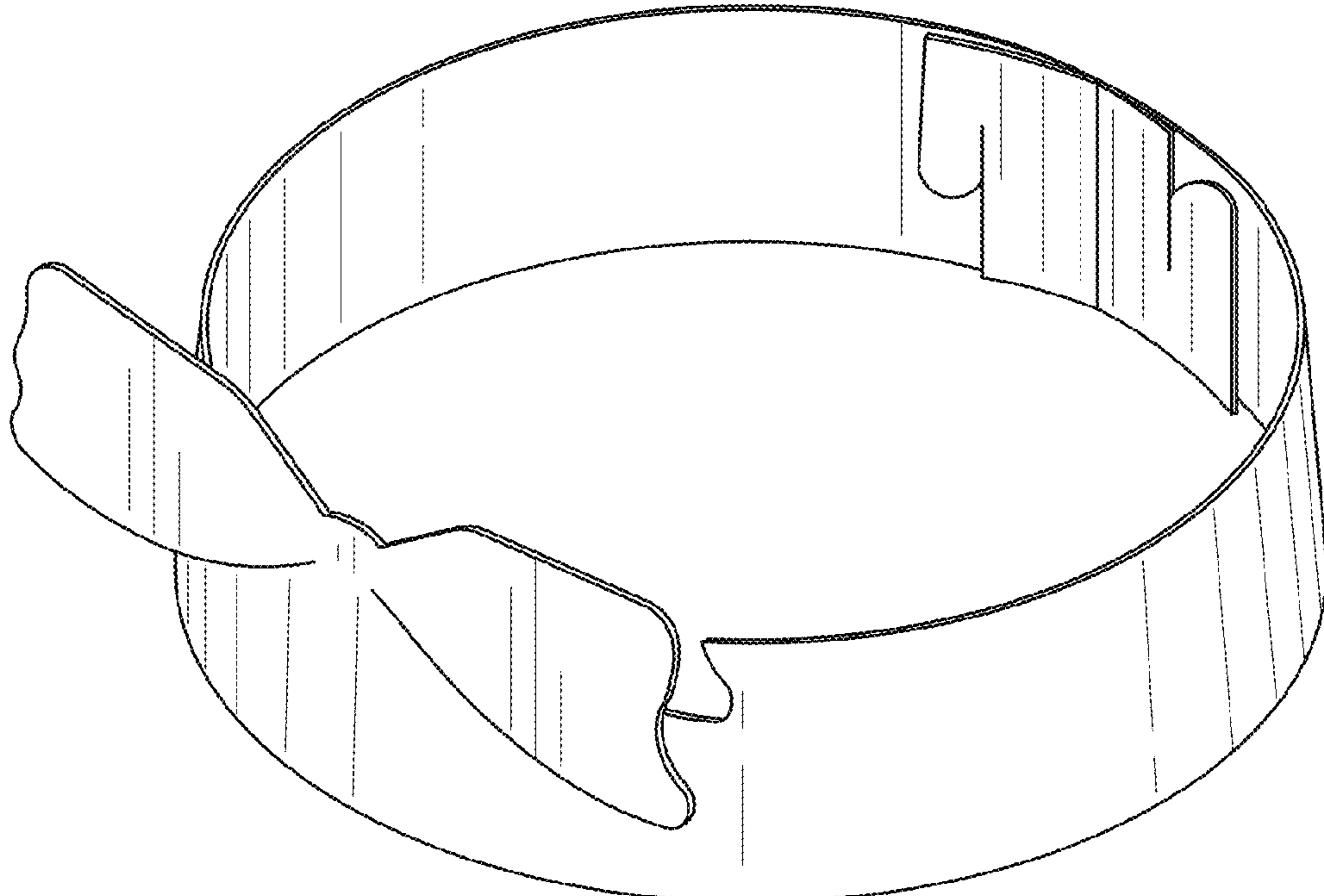

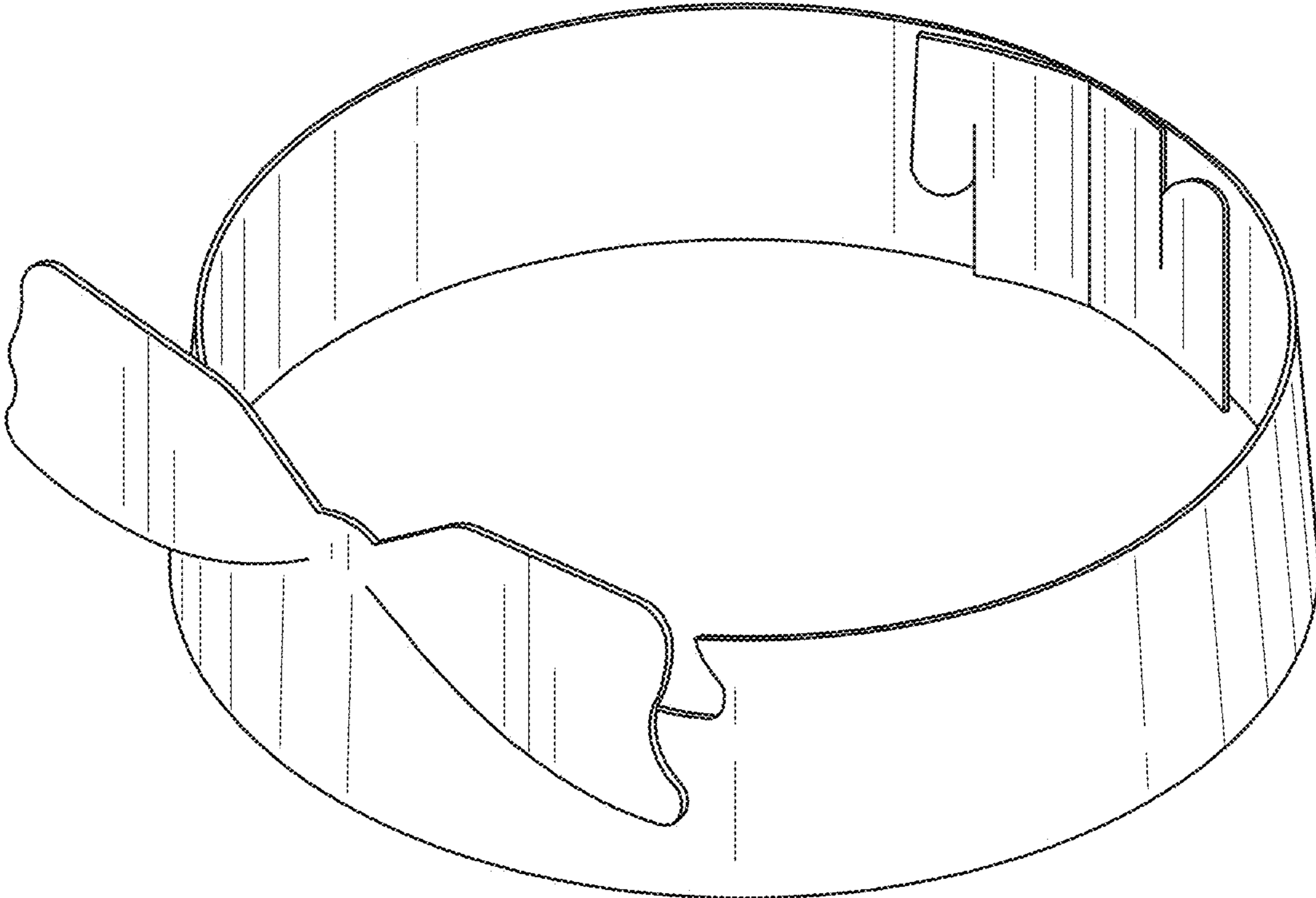

FIG. 1

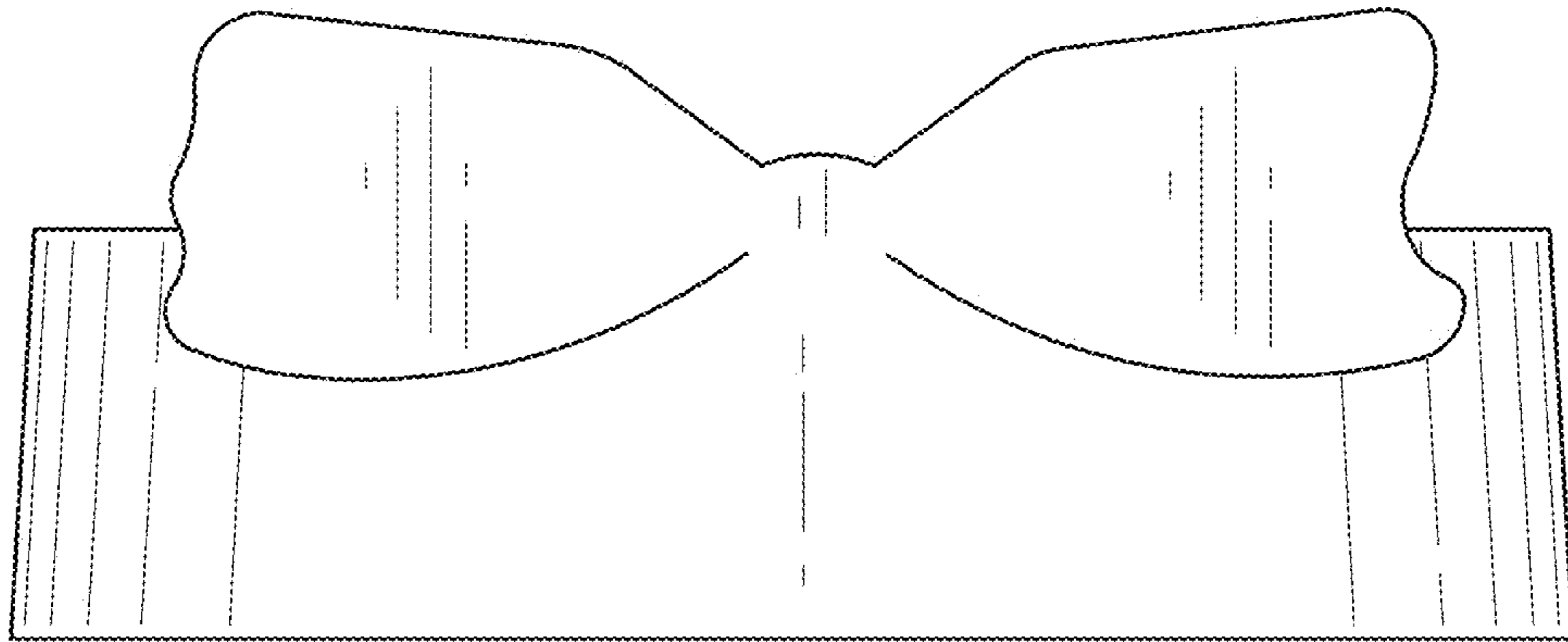

FIG. 2

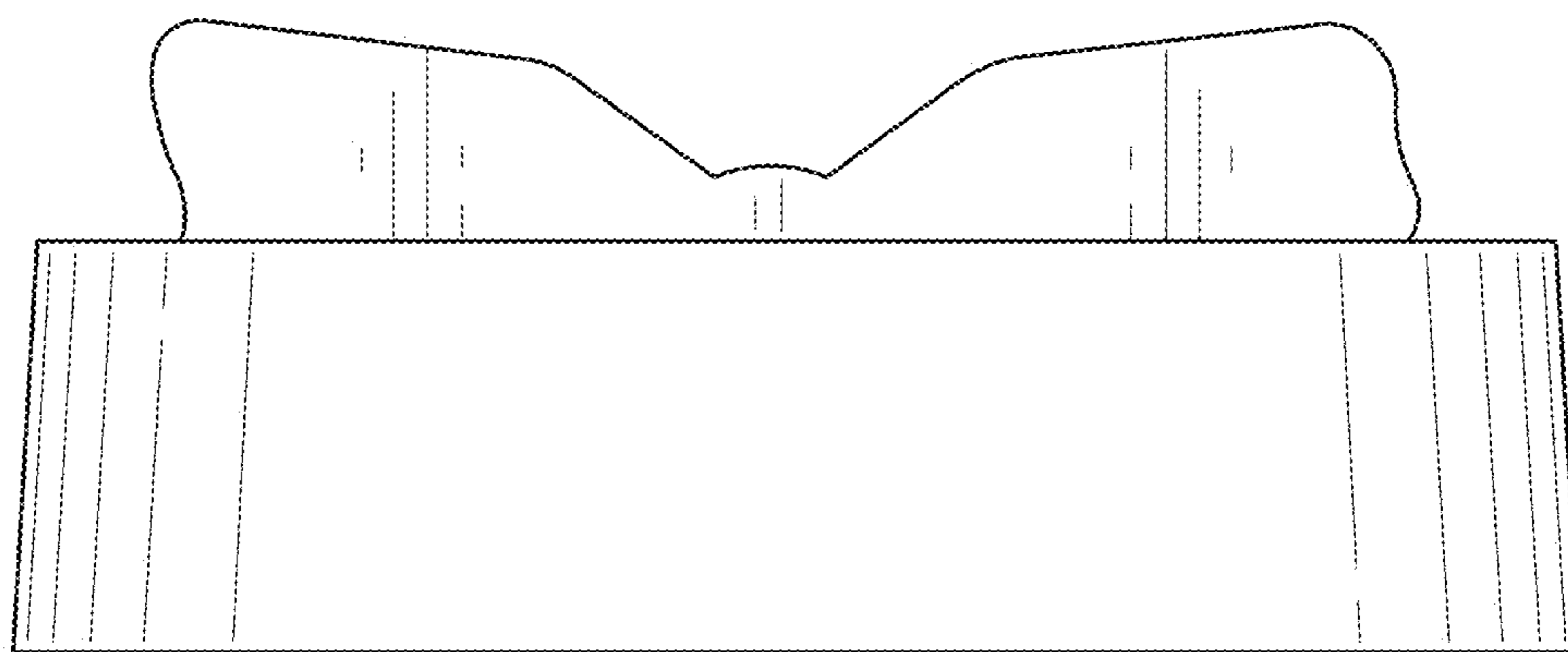

FIG. 3

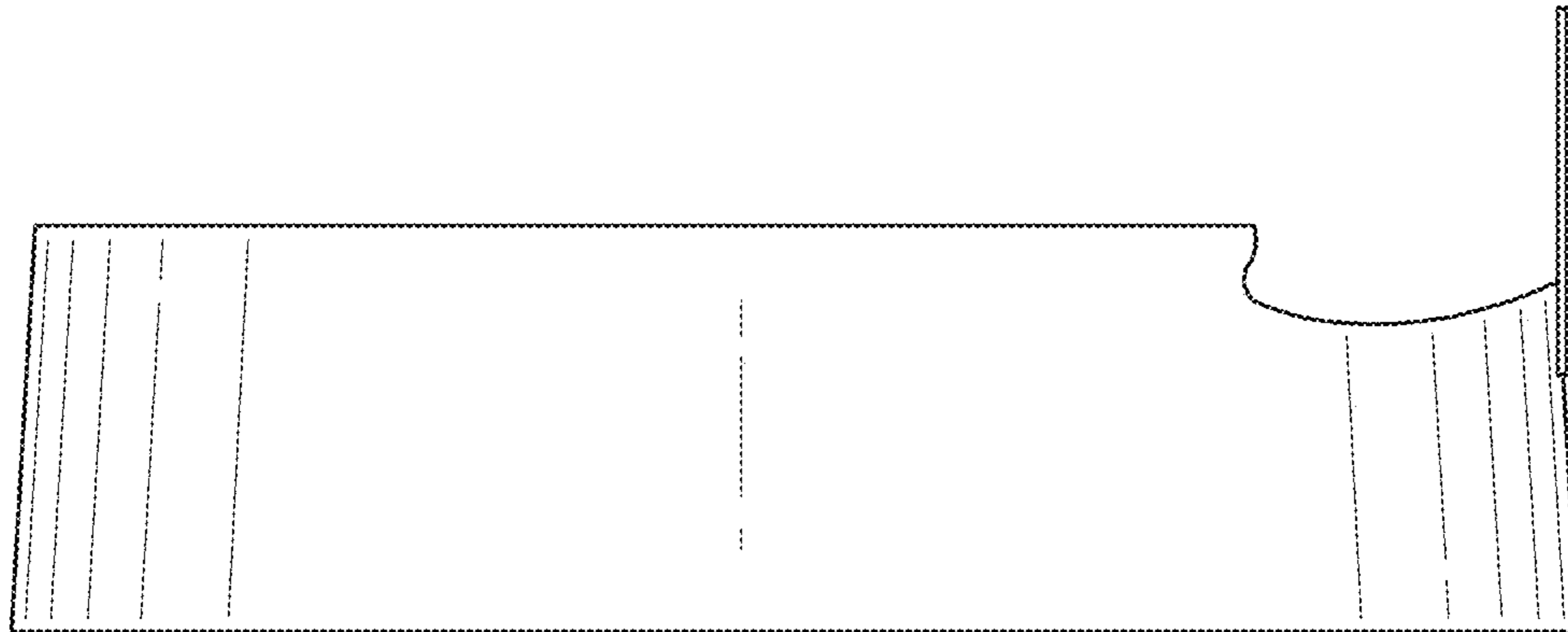

FIG. 4

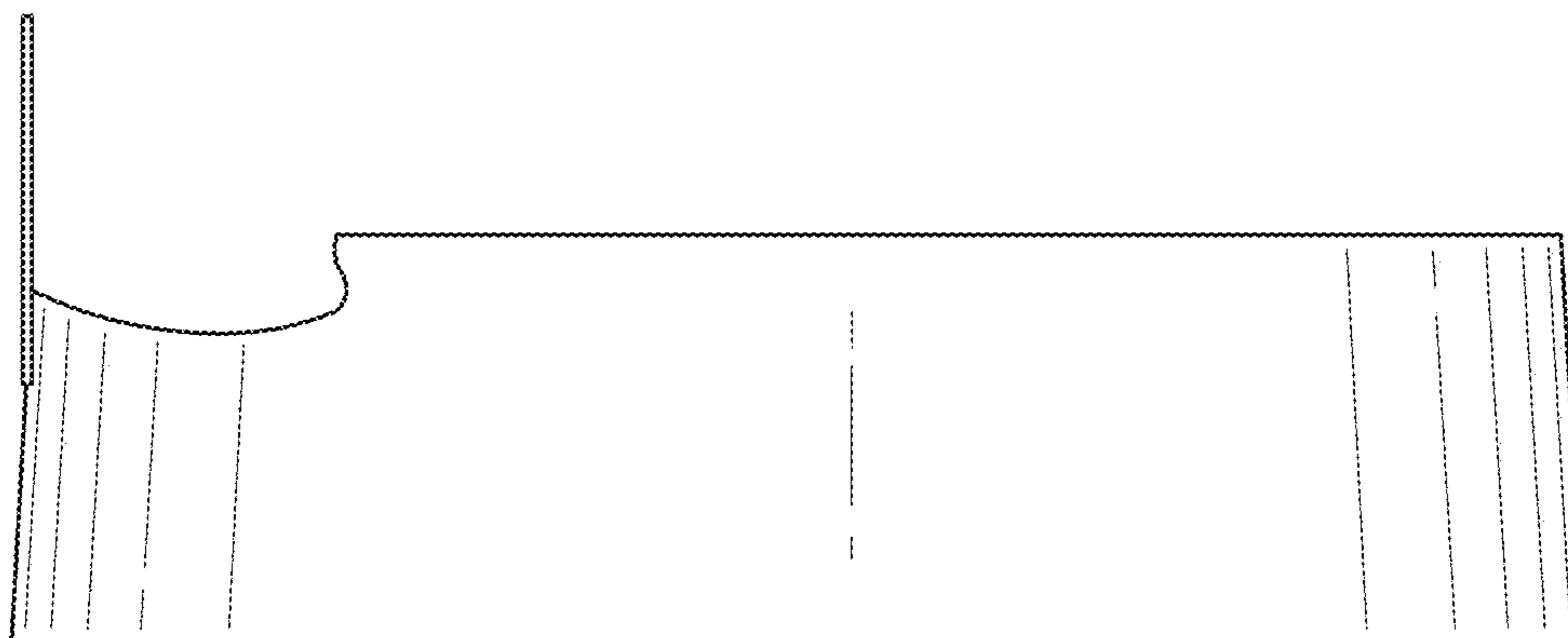

FIG. 5

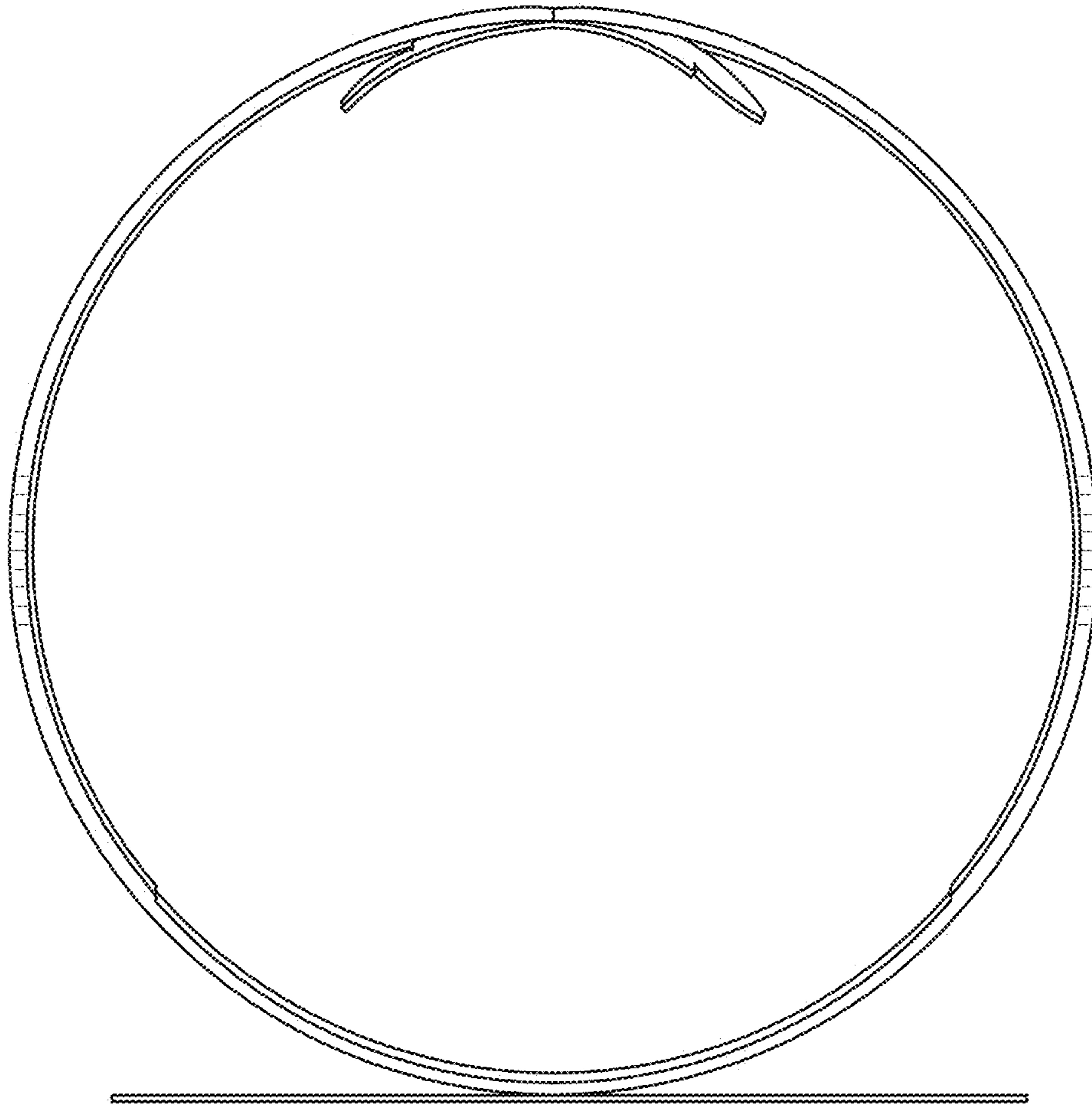

FIG. 6

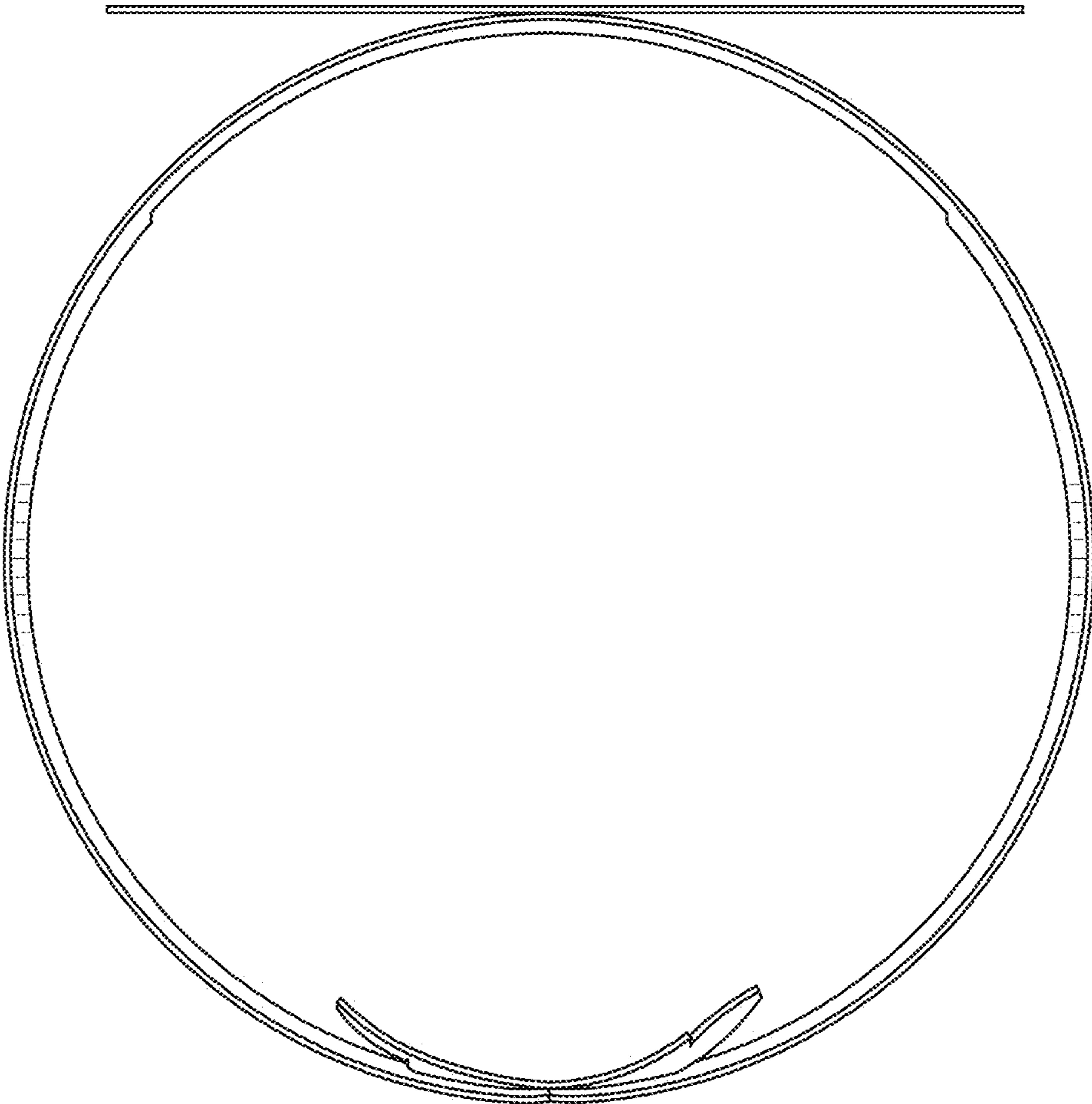

FIG. 7

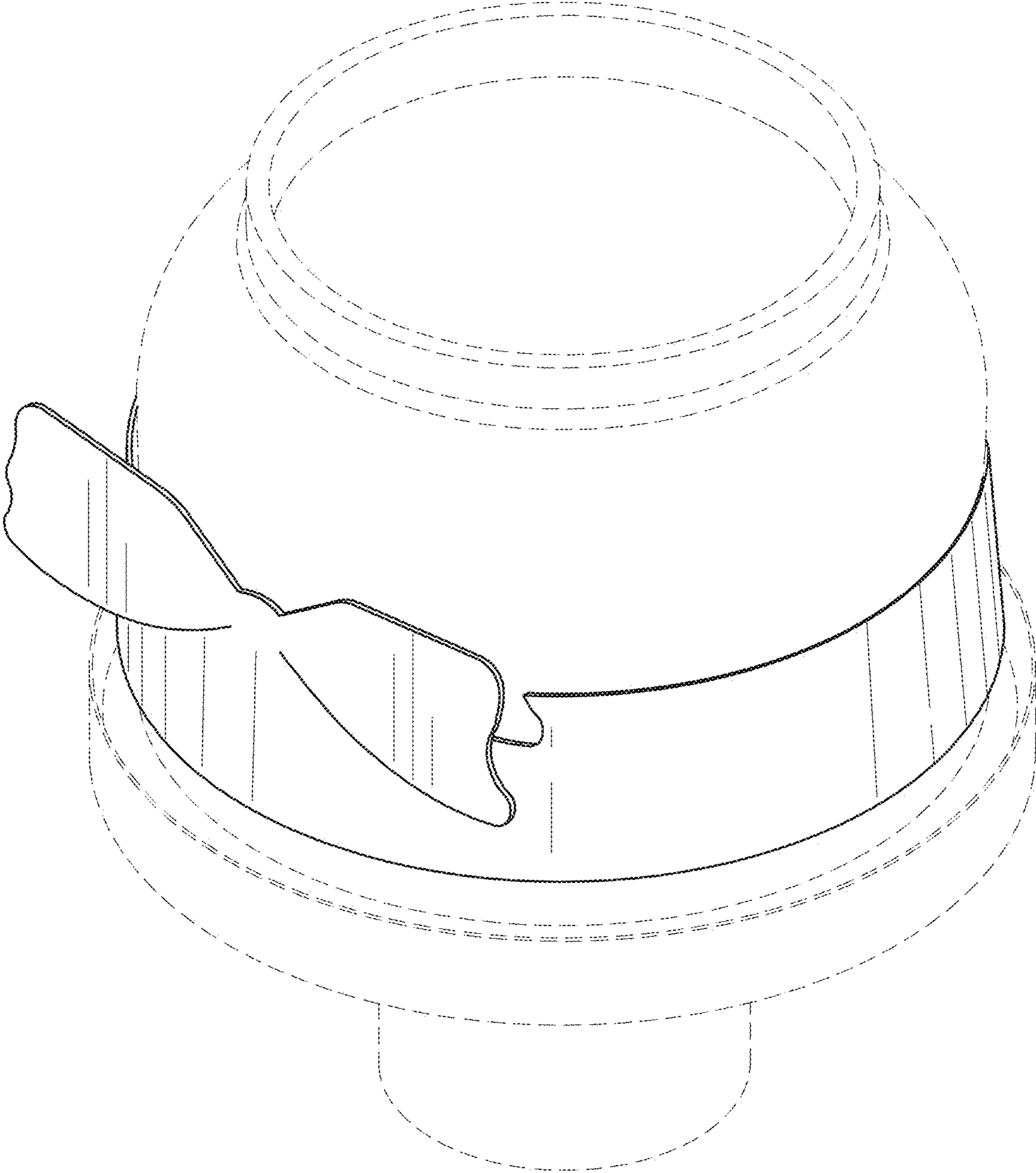

FIG. 8

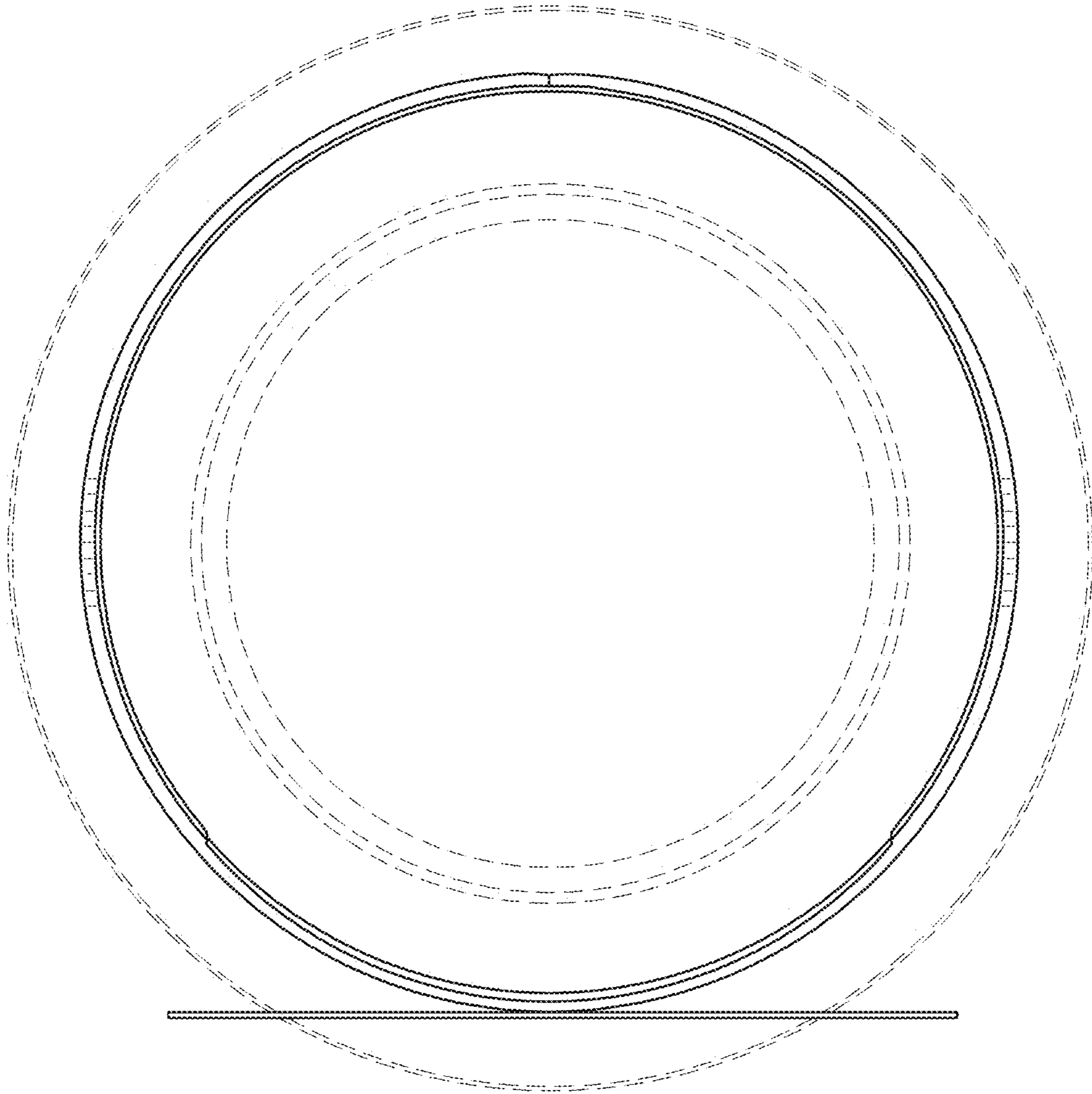

FIG. 9