



US00D910967S

(12) **United States Design Patent** (10) **Patent No.:** **US D910,967 S**
Podbelsek et al. (45) **Date of Patent:** **** Feb. 23, 2021**

(54) **SCAFFOLDING FOR ICE CREAM CONE HANDLE VARIATIONS**

D658,402 S * 5/2012 Alimenti D6/703
D681,908 S * 5/2013 Martellato D1/105
9,993,007 B1 * 6/2018 Podbelsek A21D 13/33
D851,331 S * 6/2019 Grace D28/18

(71) Applicants: **Jake Podbelsek**, Highland Park, IL (US); **Alix Podbelsek**, Highland Park, IL (US)

* cited by examiner

(72) Inventors: **Jake Podbelsek**, Highland Park, IL (US); **Alix Podbelsek**, Highland Park, IL (US)

Primary Examiner — Katie Jane Stofko
(74) *Attorney, Agent, or Firm* — Lesley A. Wallerstein, LLC

(**) Term: **15 Years**

(57) **CLAIM**

The ornamental design for a scaffolding for ice cream cone handle variations, as shown and described.

(21) Appl. No.: **29/705,128**

DESCRIPTION

(22) Filed: **Sep. 10, 2019**

(51) **LOC (13) Cl.** **01-01**

(52) **U.S. Cl.**
USPC **D1/105**

(58) **Field of Classification Search**
USPC D1/100–130, 199; 426/104, 115, 121, 426/129, 130, 144, 249, 274, 303, 414, 426/420; D21/386, 401, 722; D7/507, D7/675, 400; 220/574; D8/71; D24/122
CPC A23G 9/503; A23G 9/48; A23G 9/282; A23G 9/285; A23G 3/2023; A23L 1/0067; A21D 2/36; A21D 13/0029
See application file for complete search history.

FIG. 1 is an exploded top perspective view of a scaffolding for ice cream cone handle variations;
FIG. 2 is another top perspective view thereof;
FIG. 3 is another top perspective view thereof;
FIG. 4 is a bottom perspective view thereof;
FIG. 5 is a front elevation view thereof, the rear, right side and left side elevation views being identical thereto;
FIG. 6 is a top plan view thereof;
FIG. 7 is a bottom plan view thereof;
FIG. 8 is another top perspective view thereof, shown in an environment of use;
FIG. 9 is another top perspective view thereof, shown in an environment of use;
FIG. 10 is another top perspective view thereof, shown in an environment of use;
FIG. 11 is another top perspective view thereof, shown in an environment of use;
FIG. 12 is another top perspective view thereof, shown in an environment of use; and,
FIG. 13 is another top perspective view thereof, shown in an environment of use.
The broken lines shown in FIGS. 8-13 illustrate the environment of the claimed design and form no part thereof.

(56) **References Cited**

U.S. PATENT DOCUMENTS

D153,352 S * 4/1949 Halset D1/118
D182,376 S * 3/1958 Moslo D7/523
D285,032 S * 8/1986 Alonzo D11/152
D344,619 S * 3/1994 Klein D1/199
D431,395 S * 10/2000 Malapane D6/681.1
D456,739 S * 5/2002 Hopkins D11/149
D460,321 S * 7/2002 Ross D7/506
D465,946 S * 11/2002 Boyd, Jr. D6/681.3
D639,087 S * 6/2011 Wisniewski D6/681.3

1 Claim, 12 Drawing Sheets

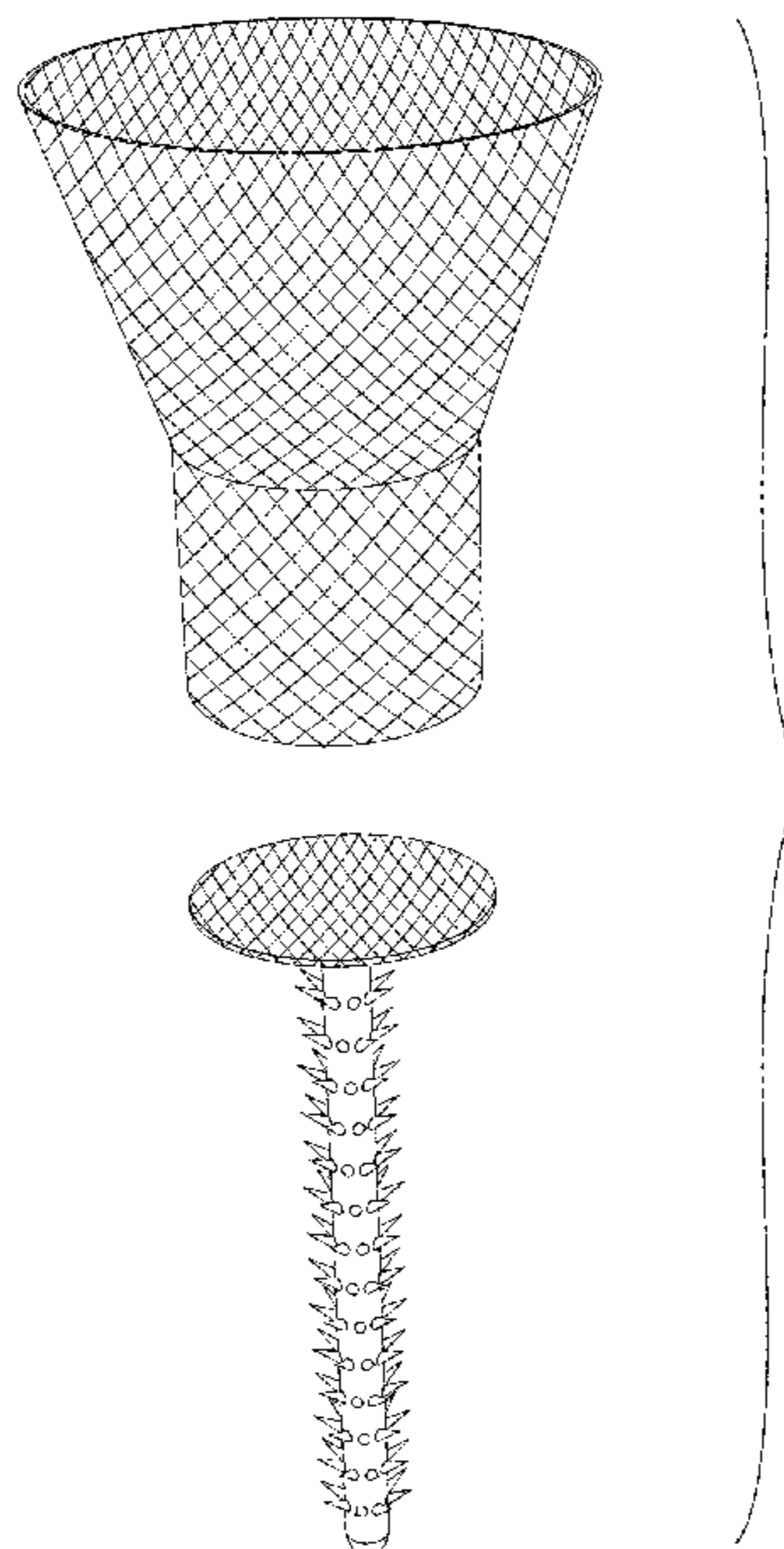

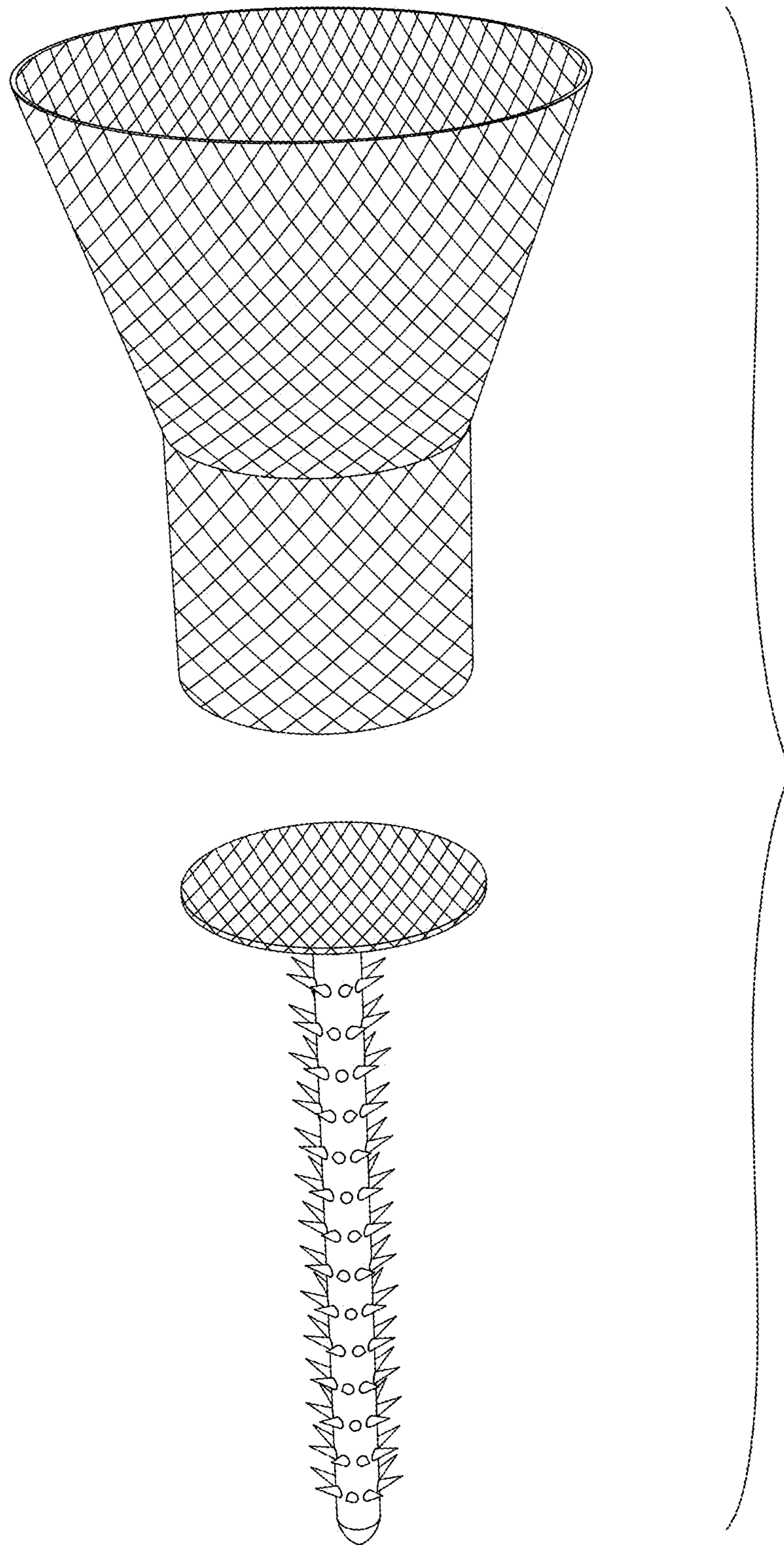

FIG. 1

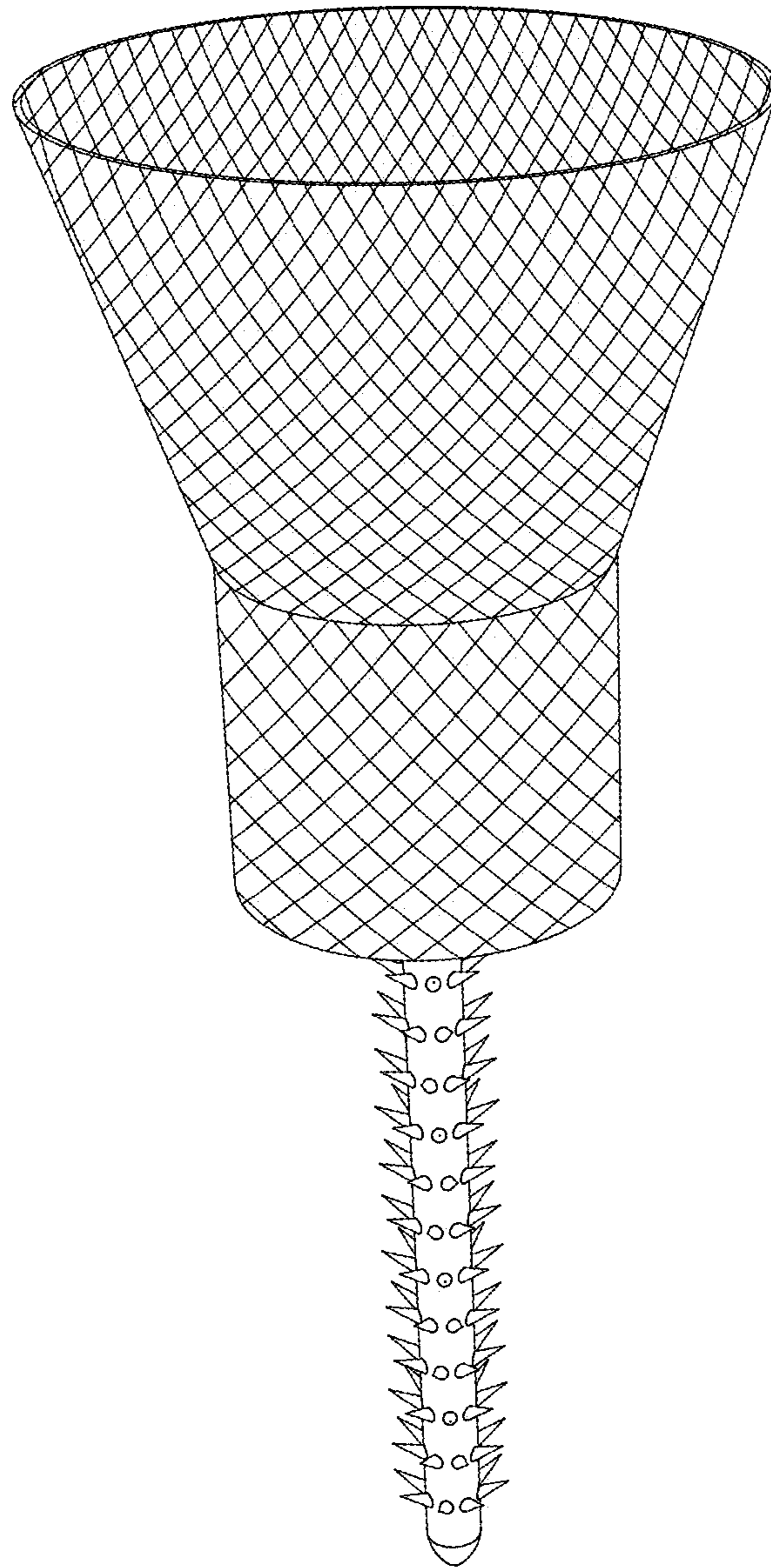

FIG. 2

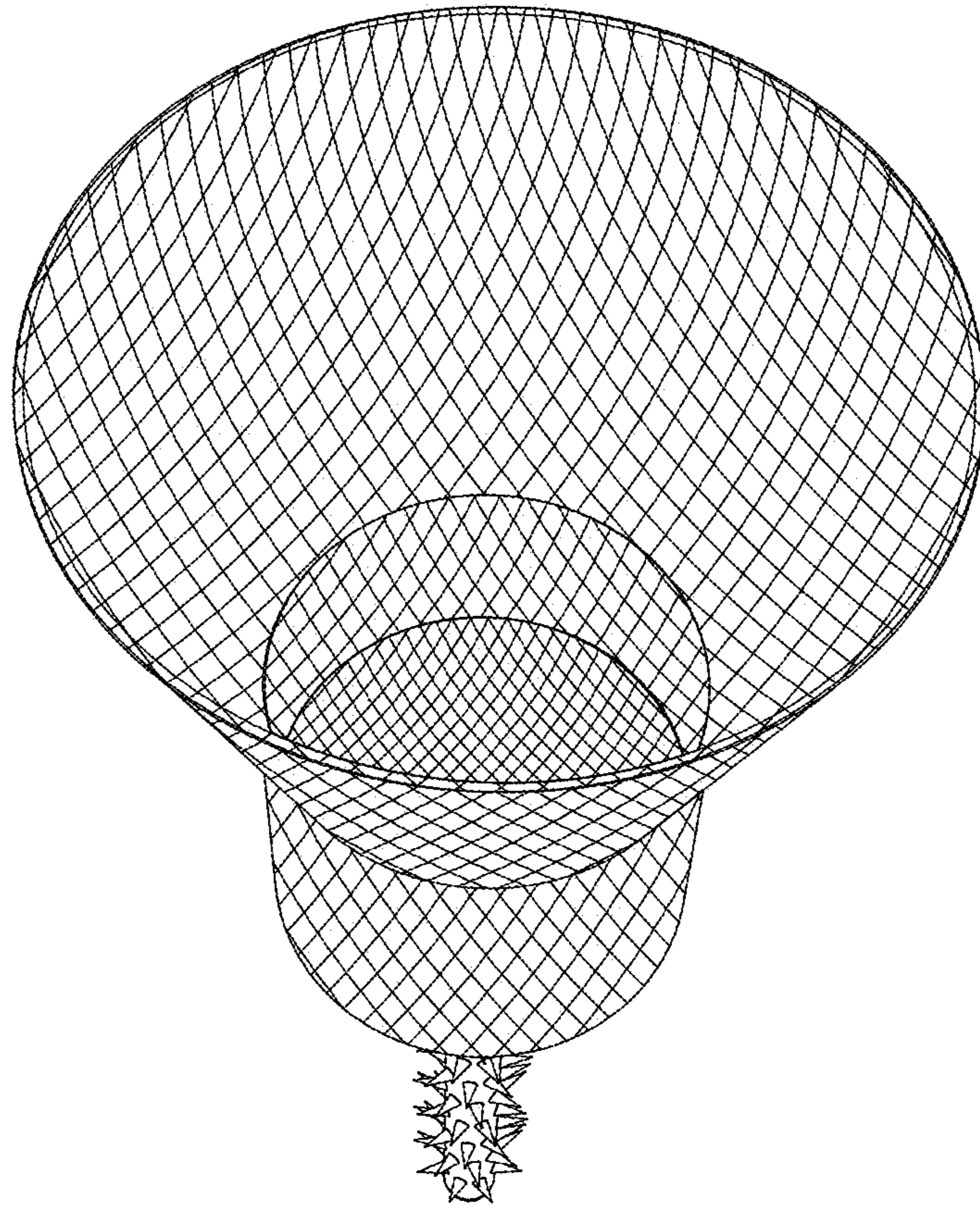

FIG. 3

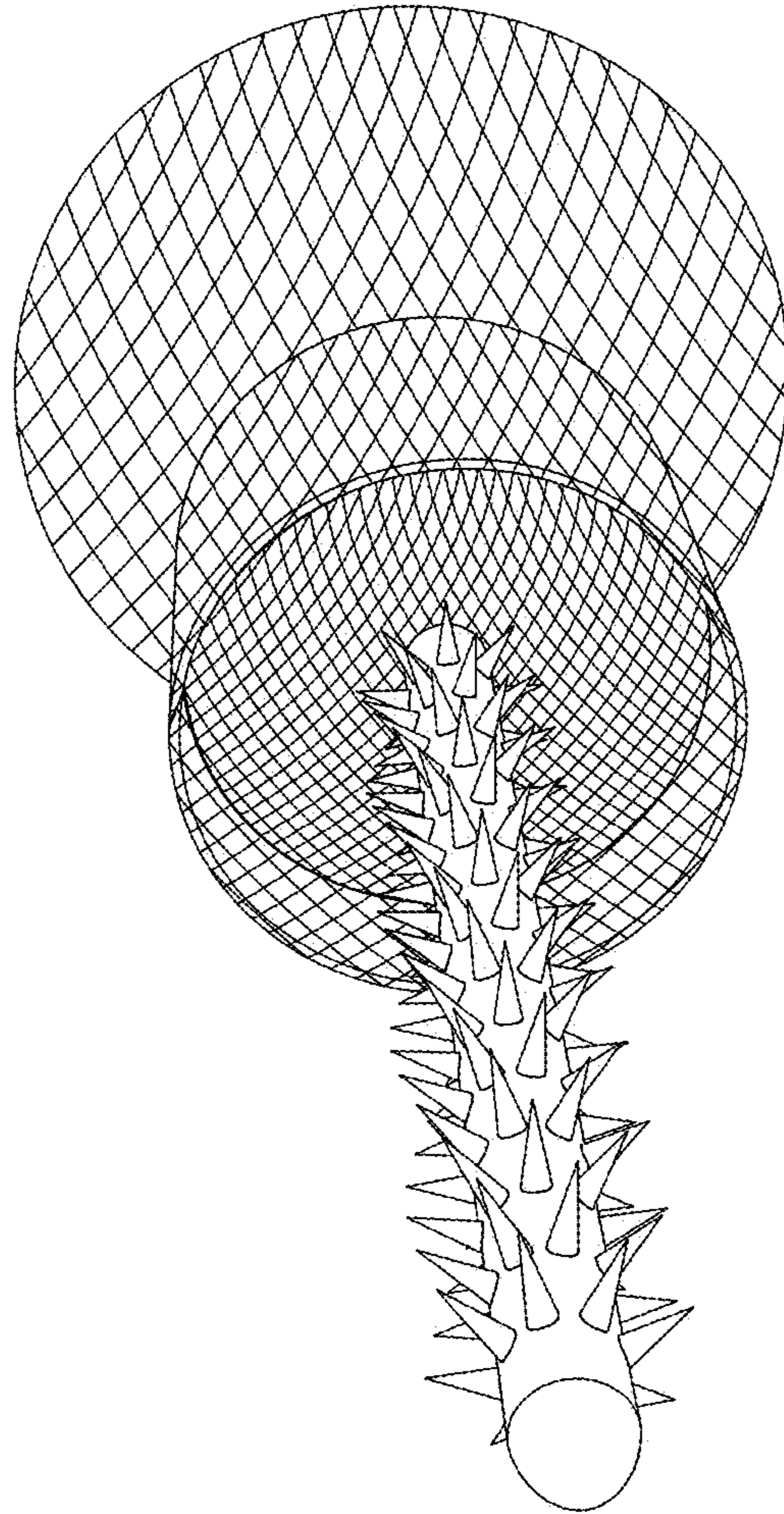

FIG. 4

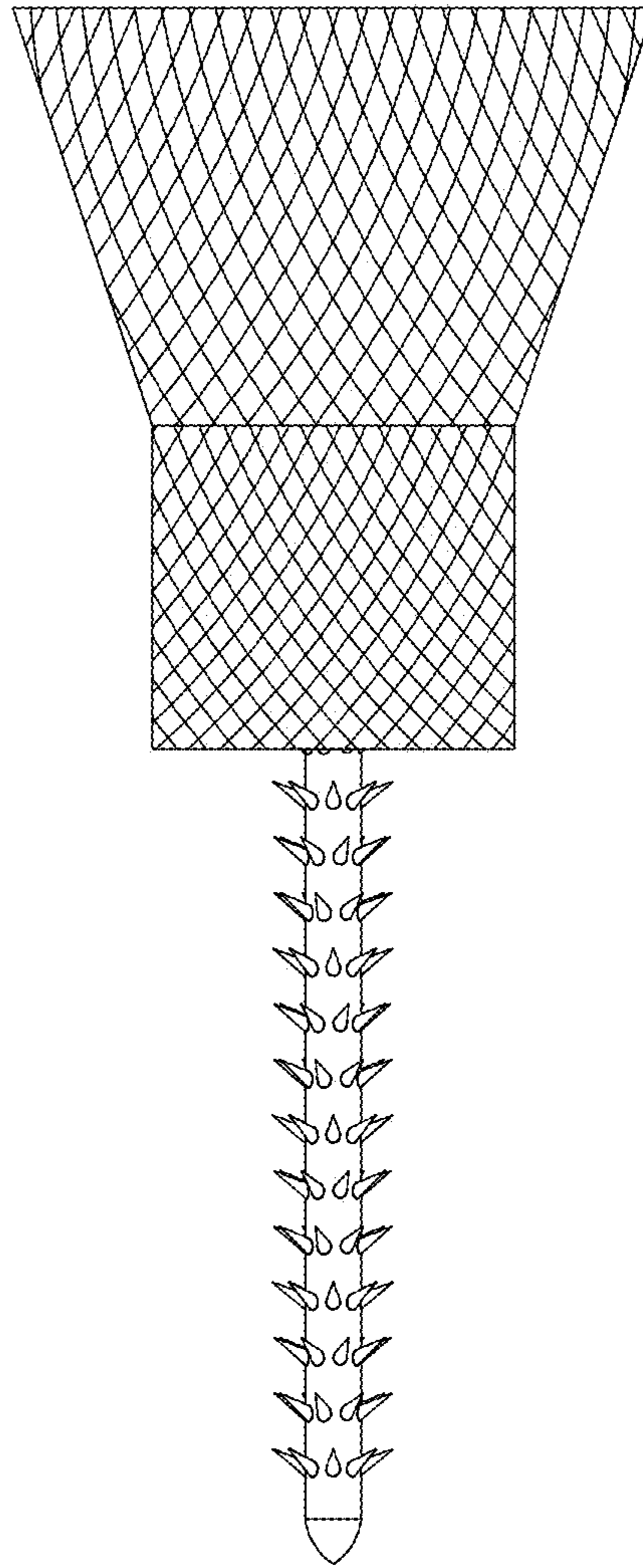

FIG. 5

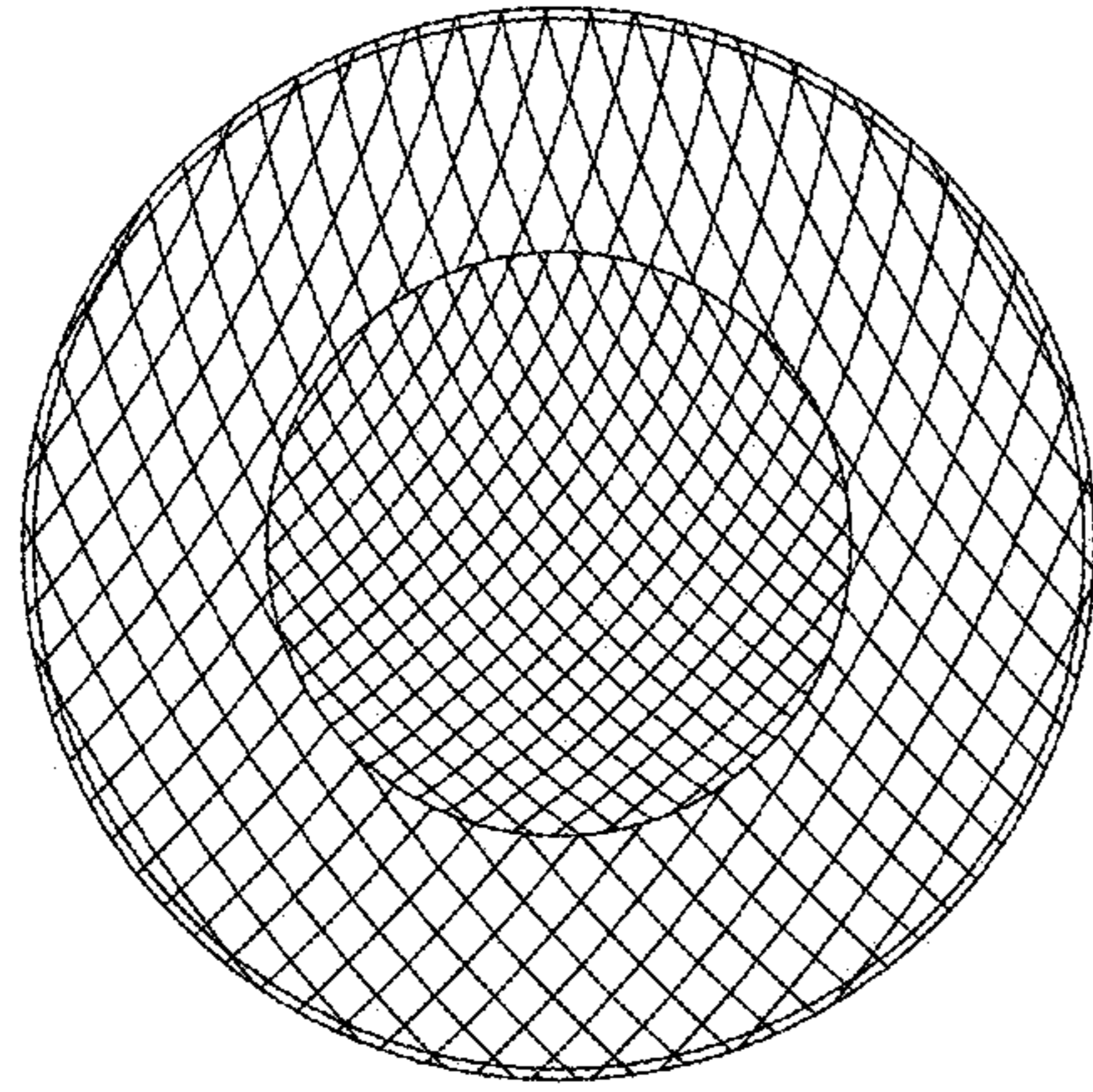

FIG. 6

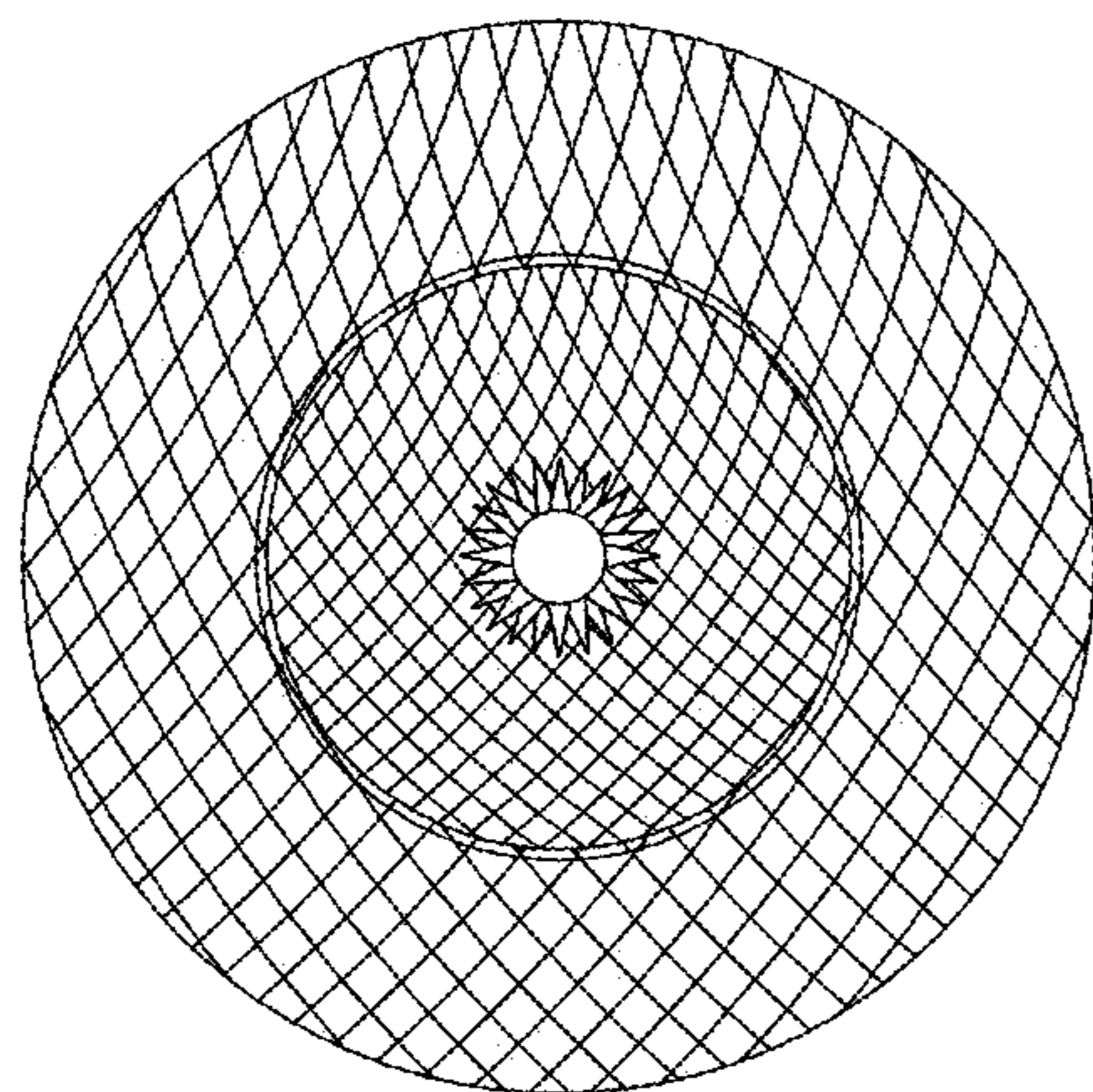

FIG. 7

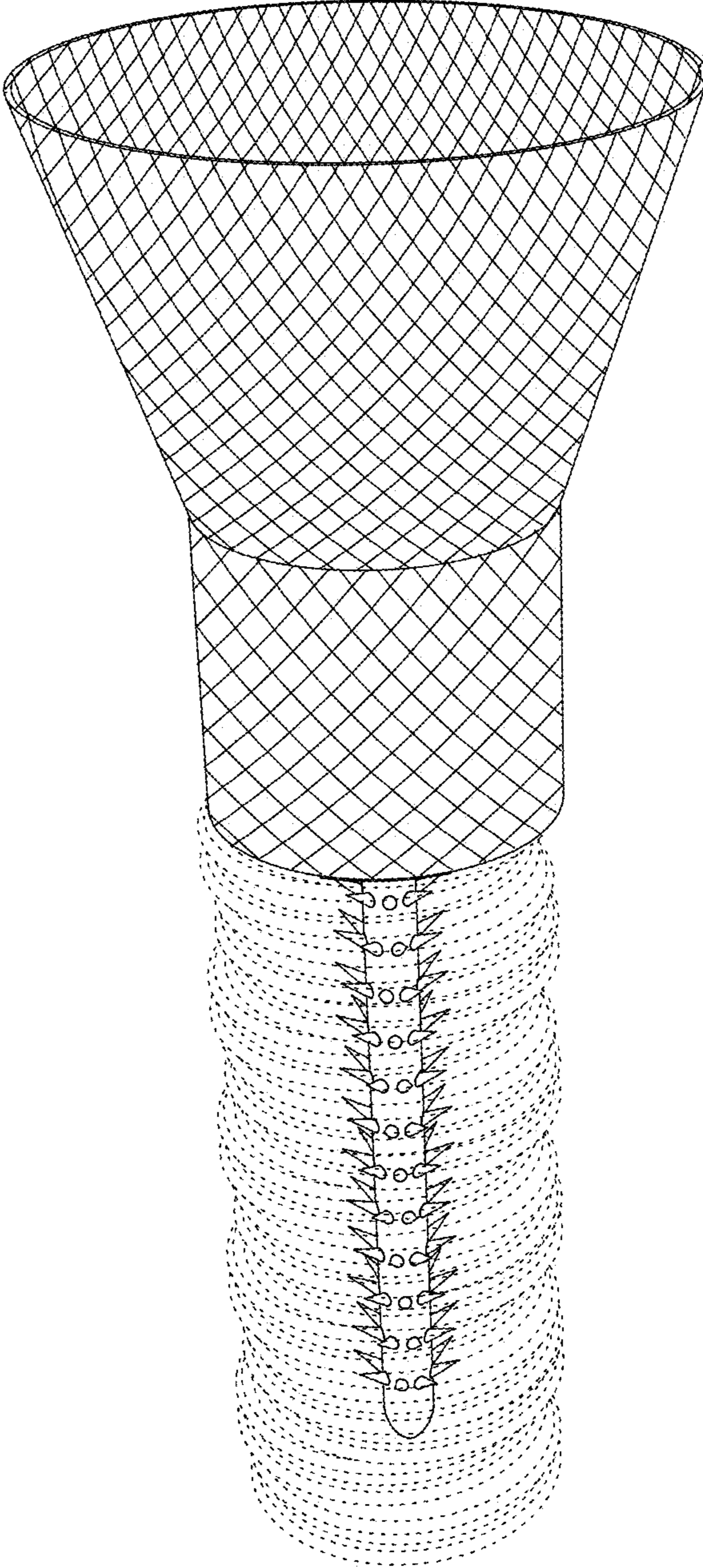

FIG. 8

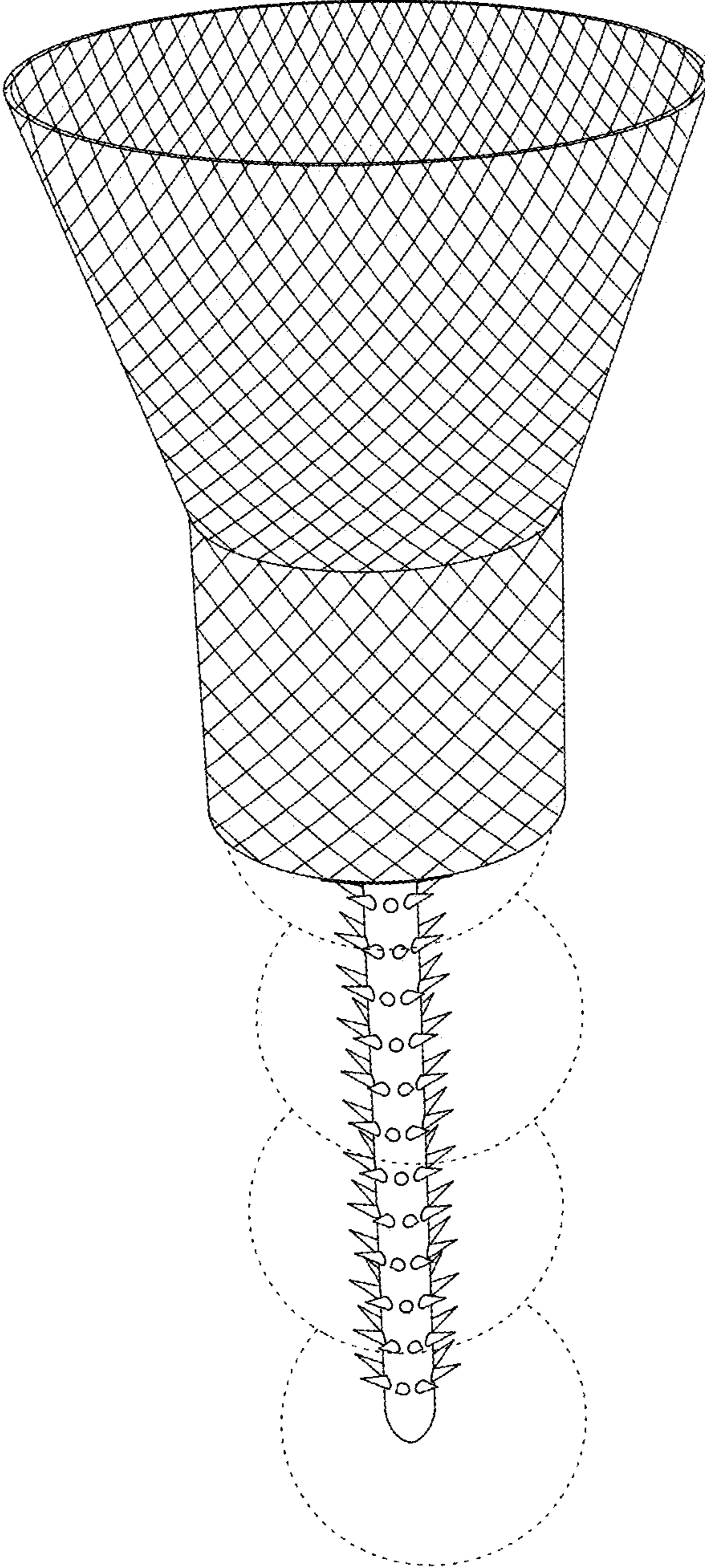

FIG. 9

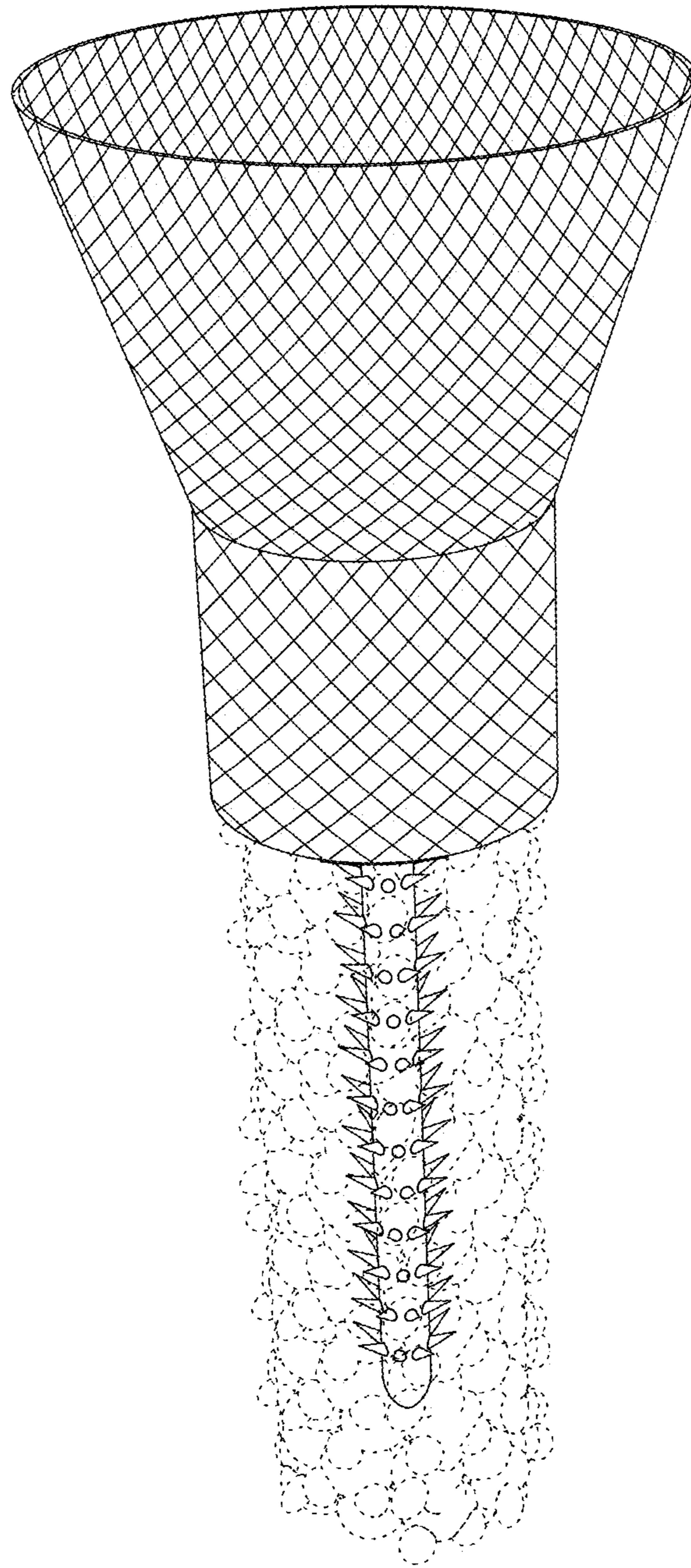

FIG. 10

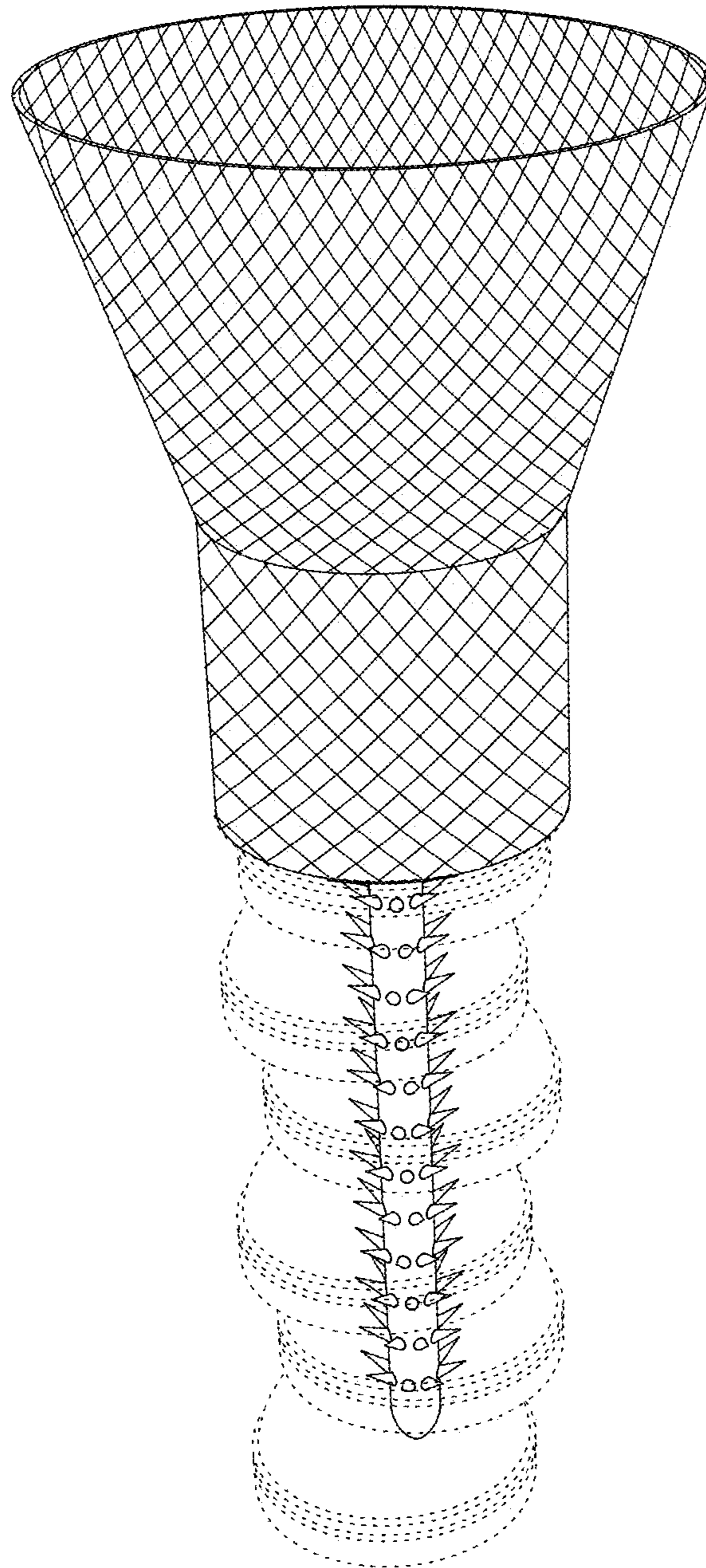

FIG. 11

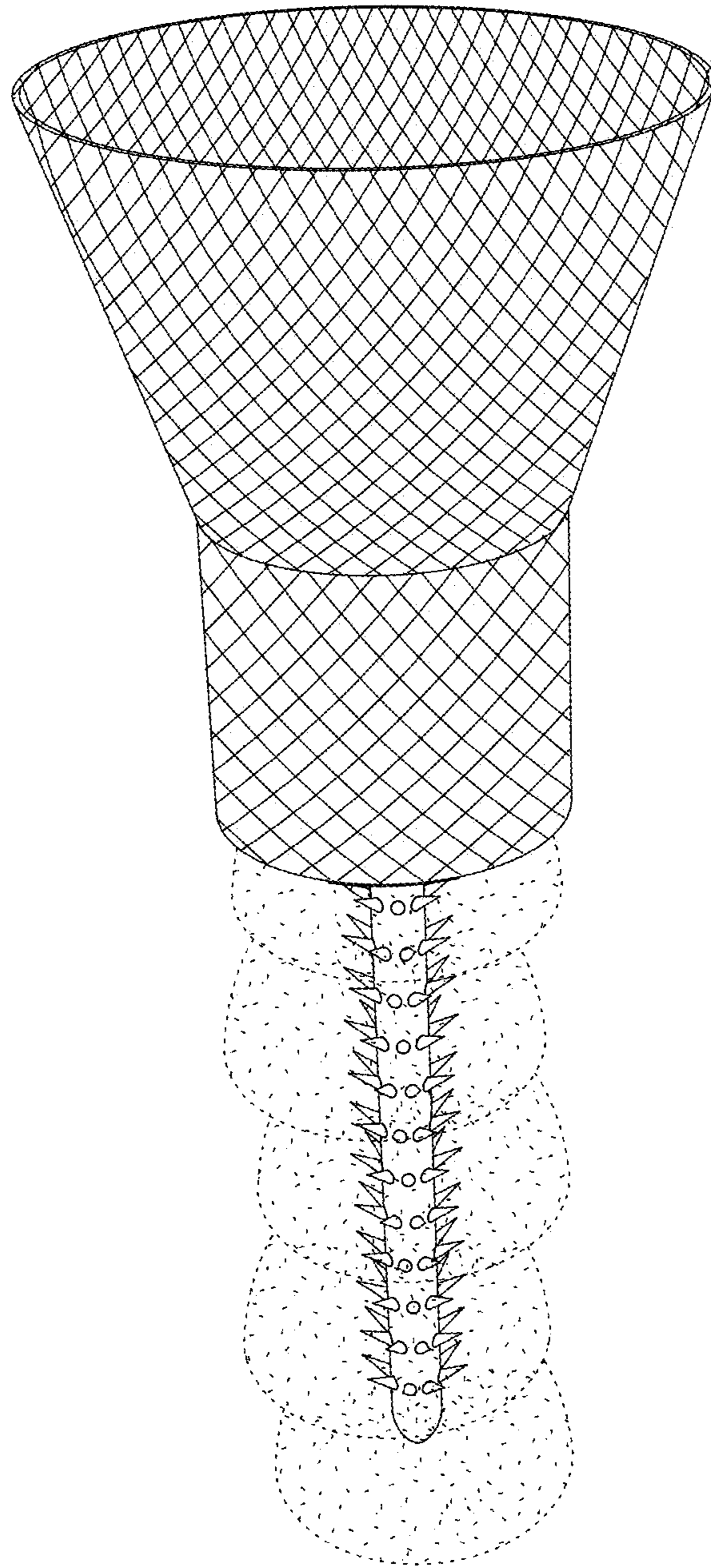

FIG. 12

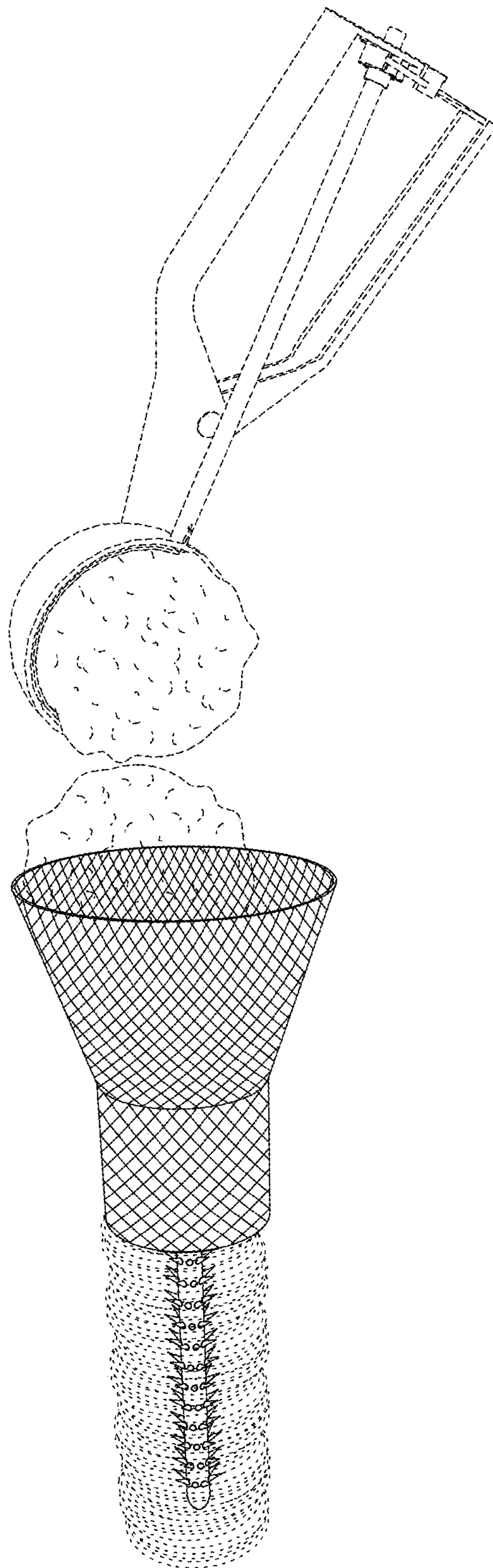

FIG. 13