



US00D910952S

(12) **United States Design Patent** (10) **Patent No.:** **US D910,952 S**
Bates, Jr. (45) **Date of Patent:** **** Feb. 16, 2021**

(54) **WIRE BASKET**
(71) Applicant: **Osprey Initiative, LLC**, Fairhope, AL (US)
(72) Inventor: **Donald W. Bates, Jr.**, Fairhope, AL (US)
(73) Assignee: **Osprey Initiative, LLC**, Fairhope, AL (US)

4,250,664 A 2/1981 Remke
4,362,631 A 12/1982 Bocard et al.
5,028,325 A 7/1991 Hamilton
D323,698 S 2/1992 Nelson et al.
5,165,821 A 11/1992 Fischer et al.
5,223,135 A 6/1993 MacPhee et al.
D367,102 S 2/1996 McLeaf
5,561,936 A 10/1996 Franke
D432,013 S * 10/2000 Glees D3/306
6,187,181 B1 2/2001 Stoltz et al.
6,270,683 B1 8/2001 Turner
(Continued)

(**) Term: **15 Years**

FOREIGN PATENT DOCUMENTS

(21) Appl. No.: **29/717,887**
(22) Filed: **Dec. 19, 2019**
(51) **LOC (13) Cl.** **23-99**
(52) **U.S. Cl.**
USPC **D34/1; D3/304**
(58) **Field of Classification Search**
USPC D34/1-11; D23/209; D3/304-306;
D22/121, 134, 135, 136, 146, 149
CPC E04H 4/1263; A01K 97/20; A01K 74/00;
A01K 77/00; A01K 71/00; B01D 2201/64
See application file for complete search history.

FR 2227750 11/1974
GB 2074887 A 11/1981
GB 2095571 A 10/1982

Primary Examiner — George A Bugg
Assistant Examiner — Tamara L Hahn
(74) *Attorney, Agent, or Firm* — Bush Intellectual Property Law; Kenneth M. Bush

(57) **CLAIM**

I claim the ornamental design for a wire basket, as shown and described.

DESCRIPTION

FIG. 1 is a top, front, left side perspective view of a wire basket showing my new design;
FIG. 2 is a top, rear, left side perspective view thereof;
FIG. 3 is a left side elevational view thereof; the right side elevational view being a mirror image of the left side elevational view;
FIG. 4 is a top plan view thereof;
FIG. 5 is a bottom plan view thereof;
FIG. 6 is a front elevational view thereof; and,
FIG. 7 is a rear elevational view thereof.
The broken lines shown in the figures represent portions of the wire basket that form no part of the claimed design.

(56) **References Cited**
U.S. PATENT DOCUMENTS

1,836,836 A 12/1931 Chobanoff
2,241,314 A 5/1941 Mohler
D161,816 S 2/1951 Blakeslee
2,782,546 A 2/1957 Edworthy
3,308,570 A 3/1967 Horton
3,381,408 A 5/1968 Nishimura
3,524,278 A 8/1970 Wolfe
3,653,510 A 4/1972 Fitzgerald
D232,813 S * 9/1974 Myers D3/306
3,850,807 A 11/1974 Jones
4,000,532 A 1/1977 Nielsen
4,124,981 A 11/1978 Preus
D254,503 S 3/1980 Belasquez
4,211,659 A 7/1980 Nyfeldt et al.

1 Claim, 7 Drawing Sheets

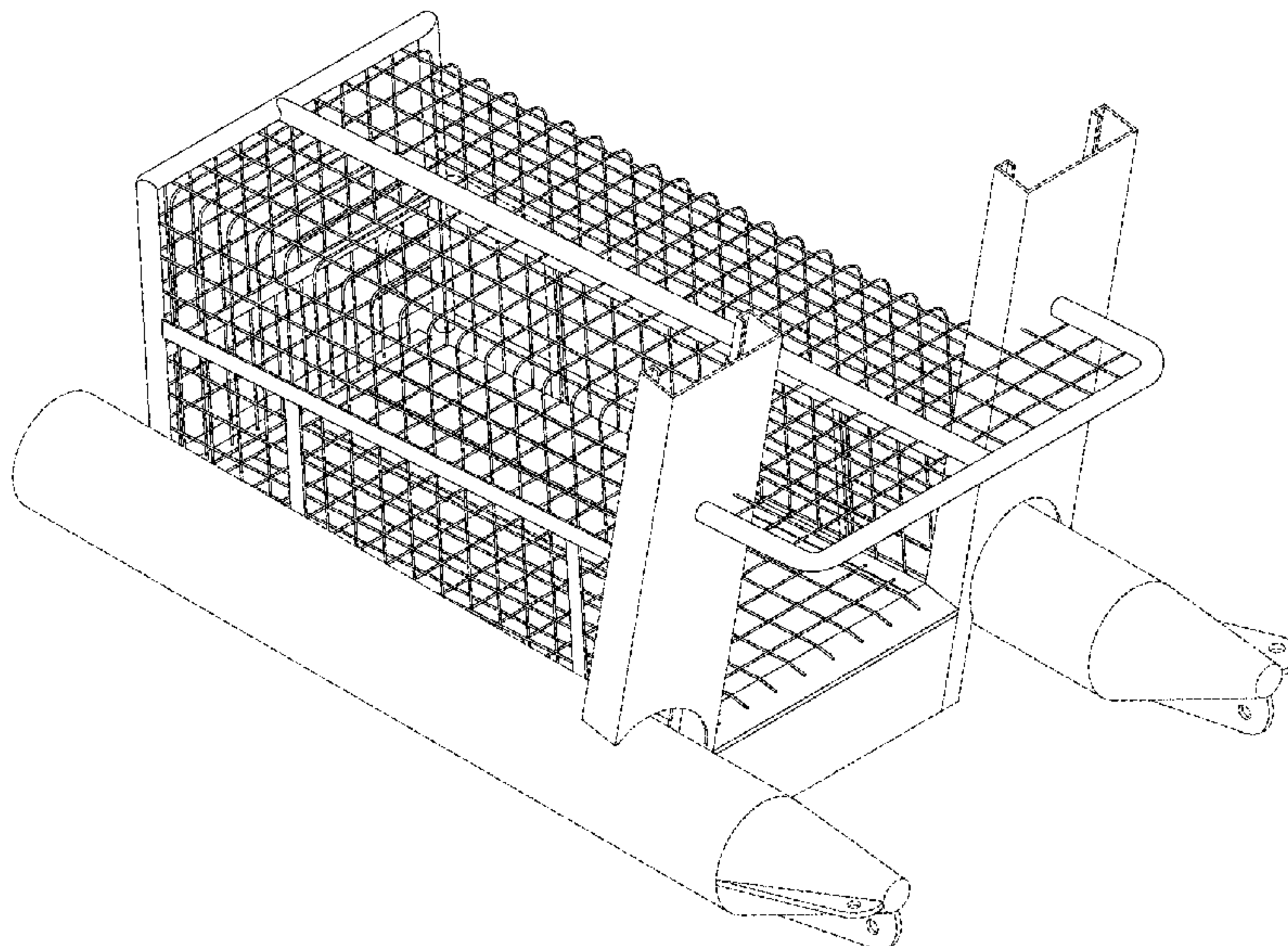

(56)

References Cited

U.S. PATENT DOCUMENTS

6,306,295	B1	10/2001	Giacalone	
6,379,541	B1	4/2002	Nicholas	
6,401,950	B1 *	6/2002	Chiang	B62B 3/005 220/1.5
D485,329	S	1/2004	Haws	
6,860,677	B2	3/2005	Johnston	
7,153,417	B2	12/2006	Happel	
D586,558	S *	2/2009	Ziemann	D3/304
D598,196	S	8/2009	Vreeland	
D620,548	S	7/2010	Vreeland	
7,972,504	B2	7/2011	Weiss	
8,001,717	B1	8/2011	Bright, II	
D655,505	S *	3/2012	James	D3/306
D667,529	S	9/2012	Vreeland	
D694,852	S	12/2013	Gordon	
D745,281	S *	12/2015	Goodman	D3/306
9,260,853	B2	2/2016	Pank	
D754,280	S	4/2016	Krieger et al.	
9,572,328	B1	2/2017	Head	
D799,827	S *	10/2017	Greenblatt	D3/306
D810,856	S	2/2018	Kelly	
10,015,954	B2	7/2018	Callingham	
10,323,375	B1	6/2019	Bates, Jr.	
D854,120	S *	7/2019	Bates, Jr.	D22/135
D901,180	S *	11/2020	Li	D3/305
2007/0151913	A1	7/2007	Riley	
2010/0025314	A1	2/2010	Cheng	
2011/0280660	A1	11/2011	Bahukudumbi et al.	
2013/0038042	A1 *	2/2013	Cimino	B62B 3/027 280/651
2013/0146519	A1	6/2013	Heimtun et al.	
2014/0158598	A1	6/2014	Happel	
2015/0034565	A1	2/2015	Vaz Viegas et al.	
2015/0247332	A1	9/2015	Norberto, III et al.	

* cited by examiner

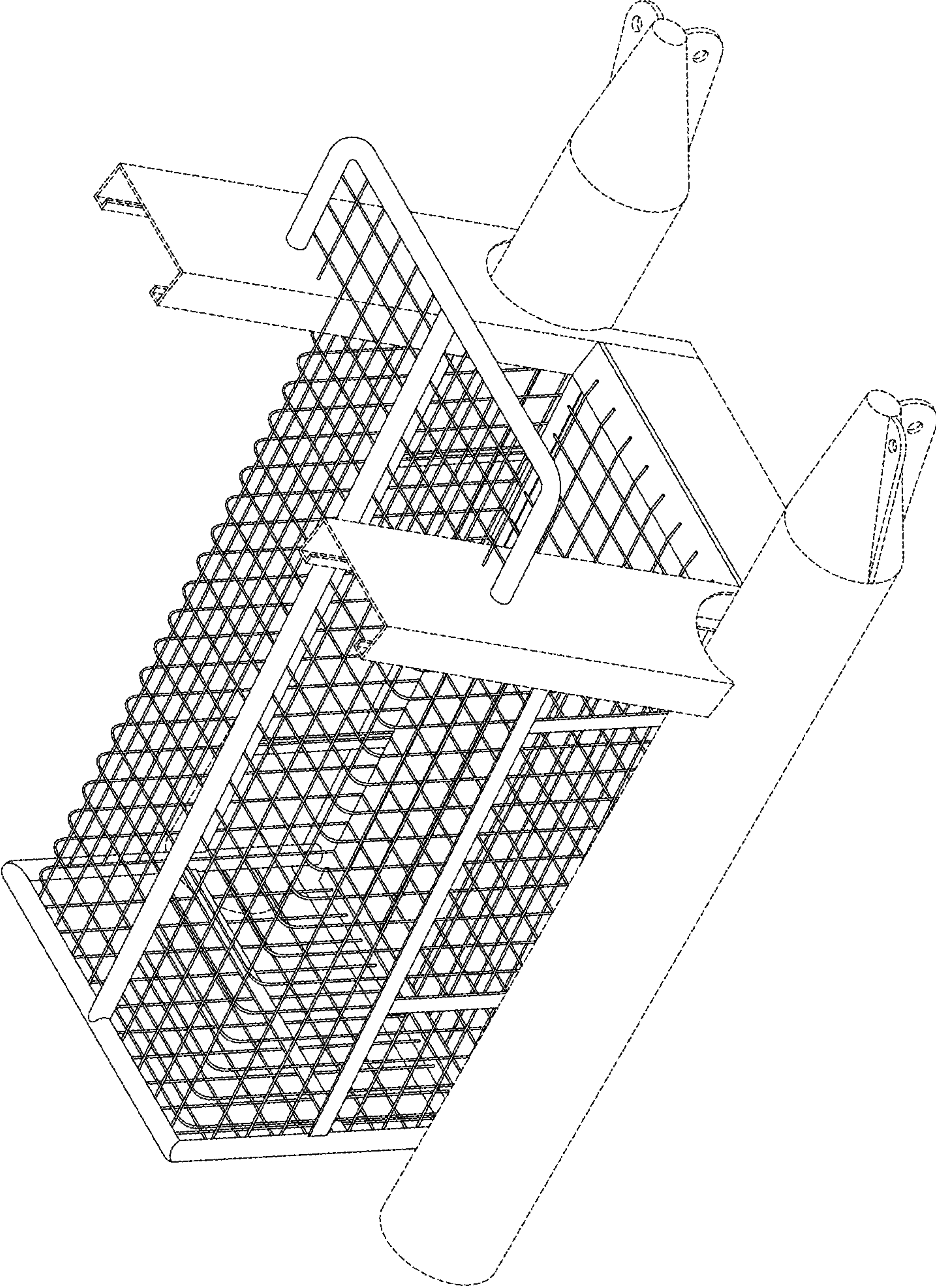

FIG. 1

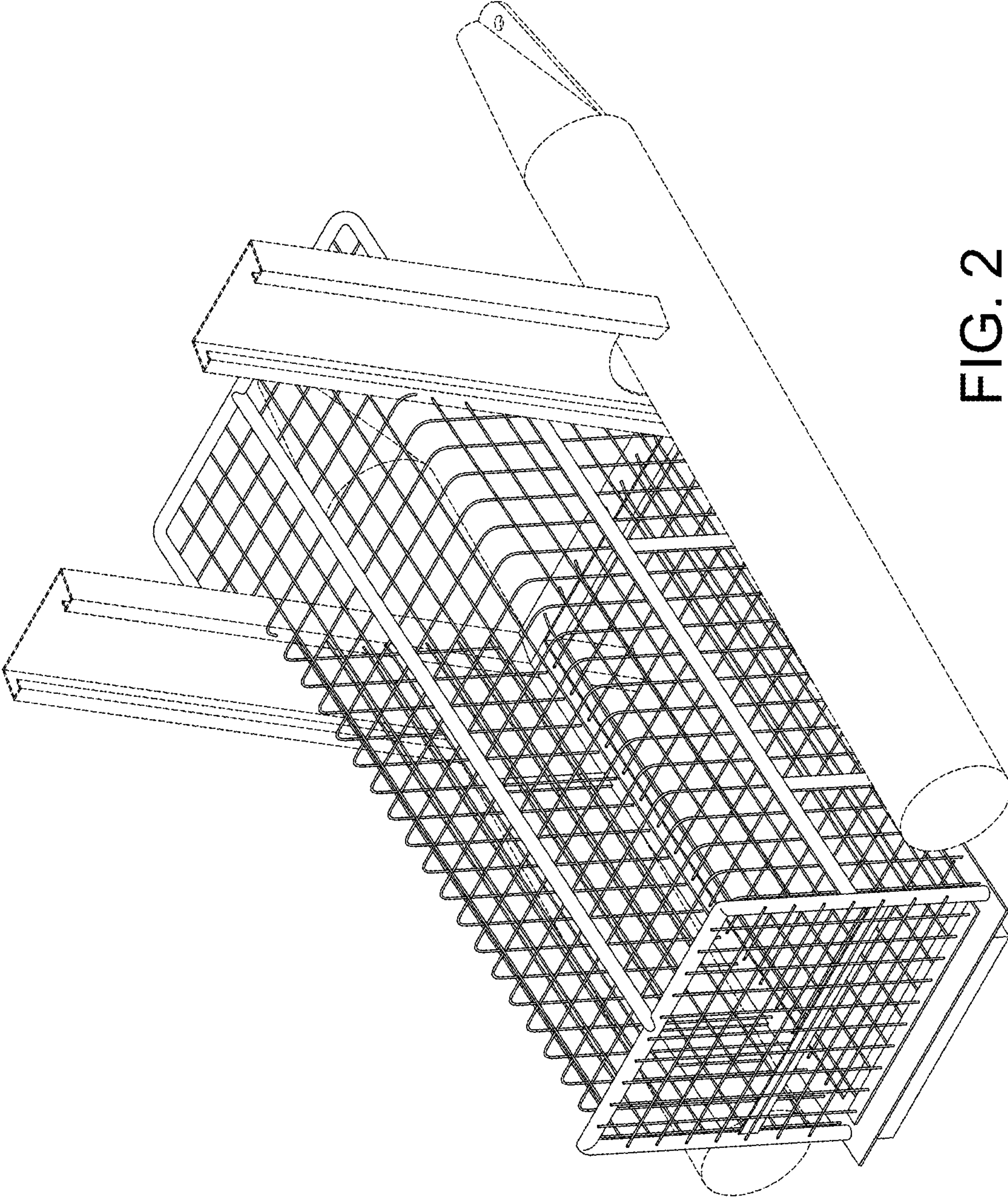

FIG. 2

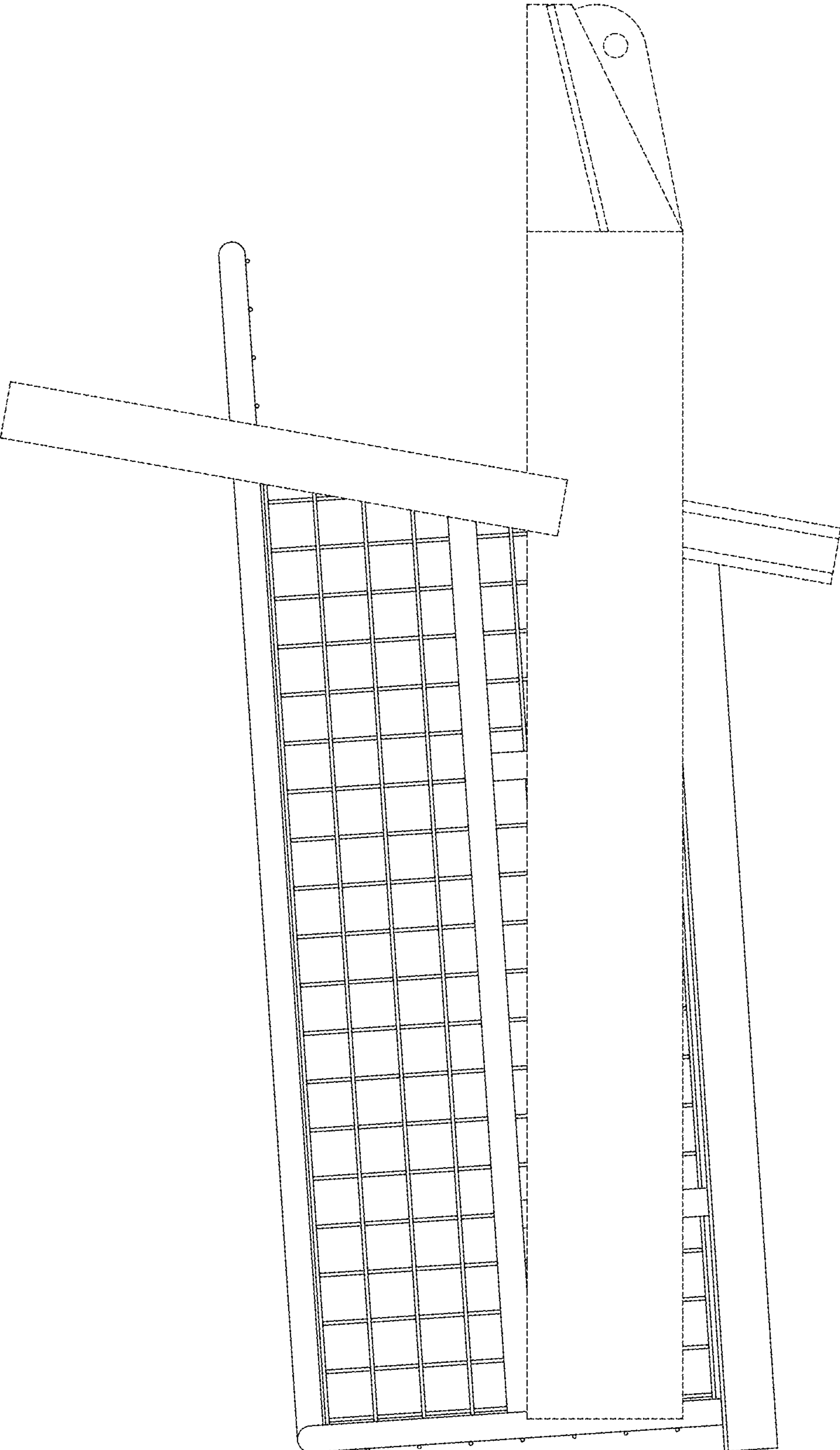

FIG. 3

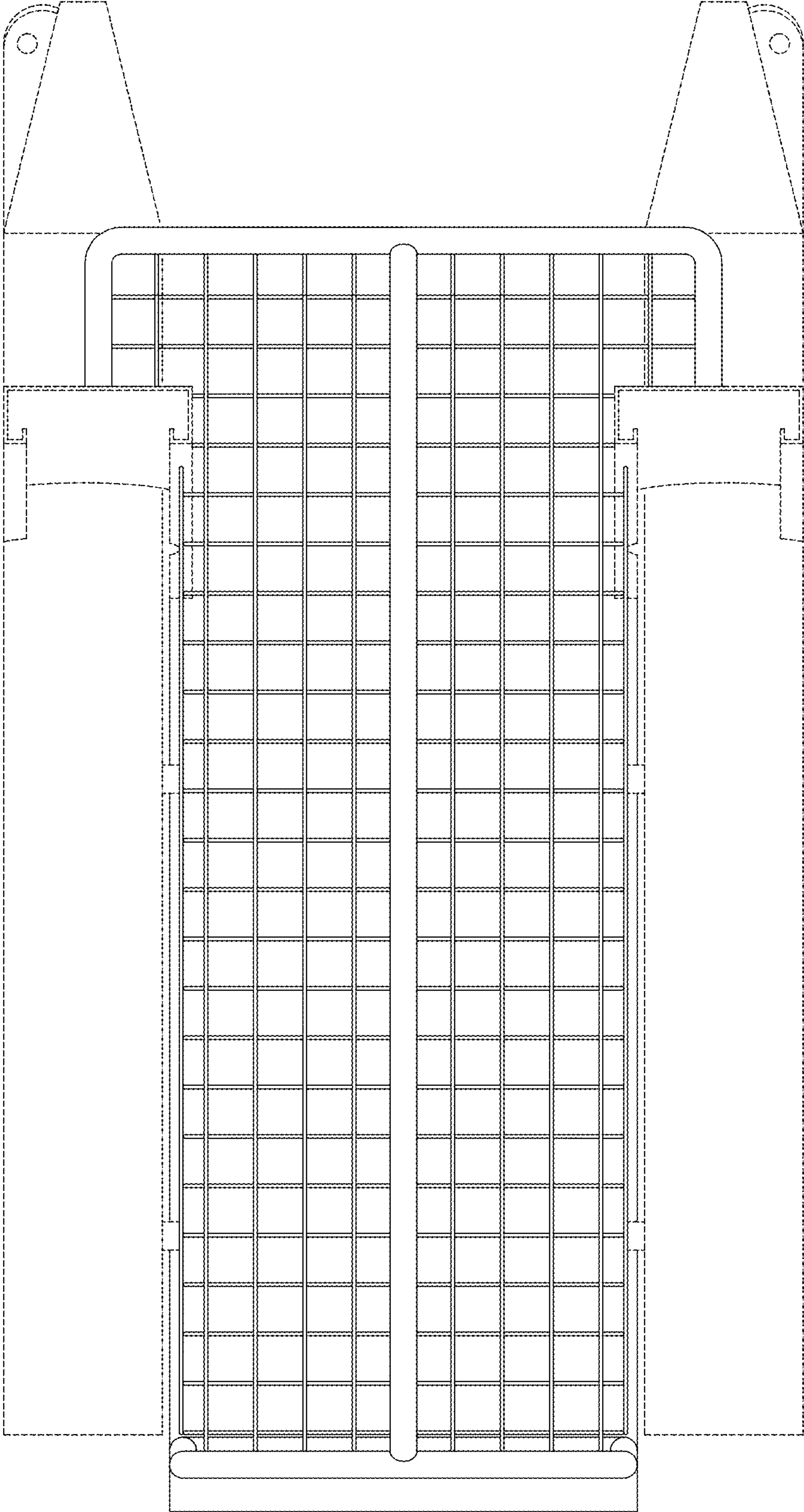

FIG. 4

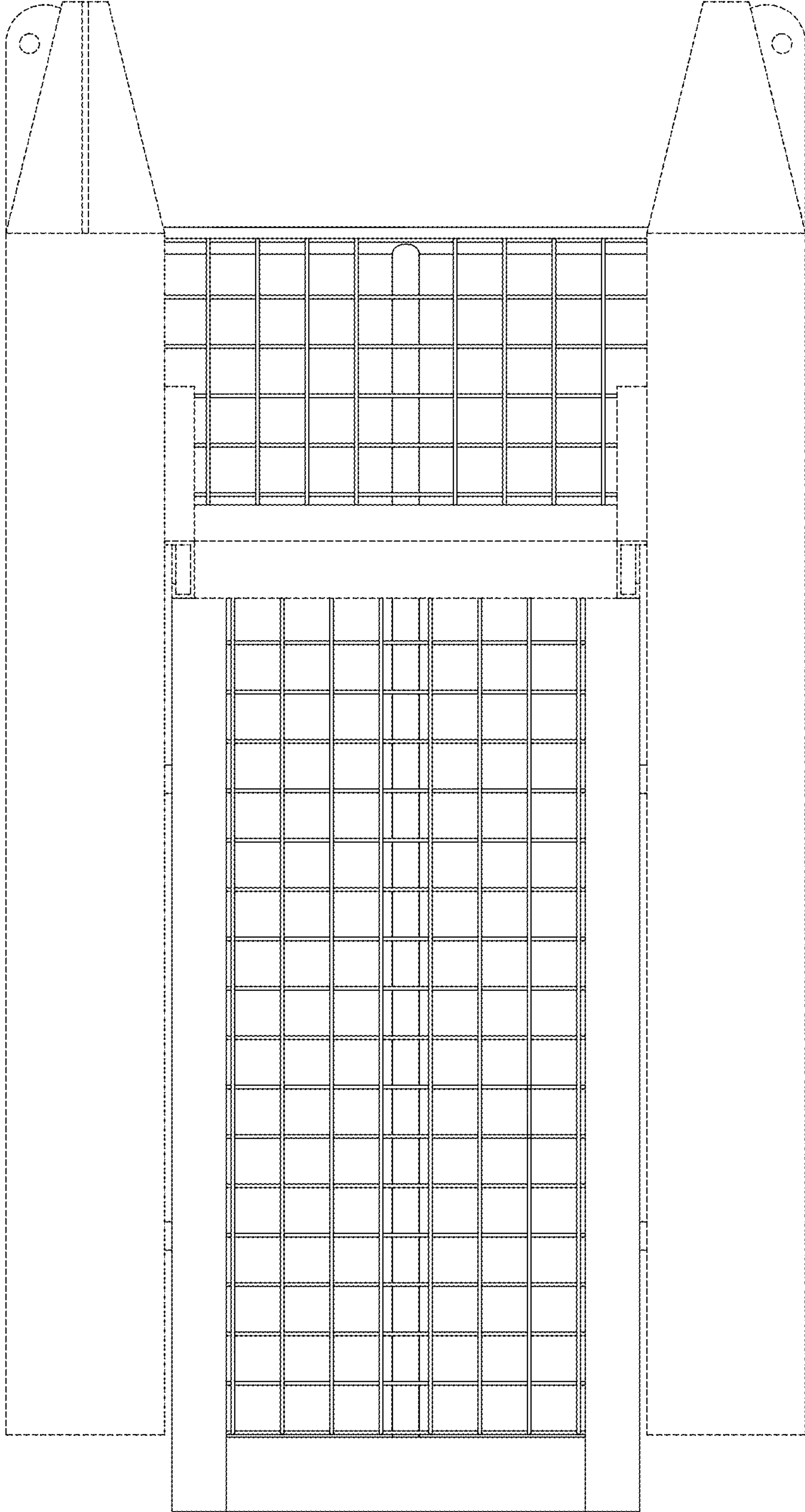

FIG. 5

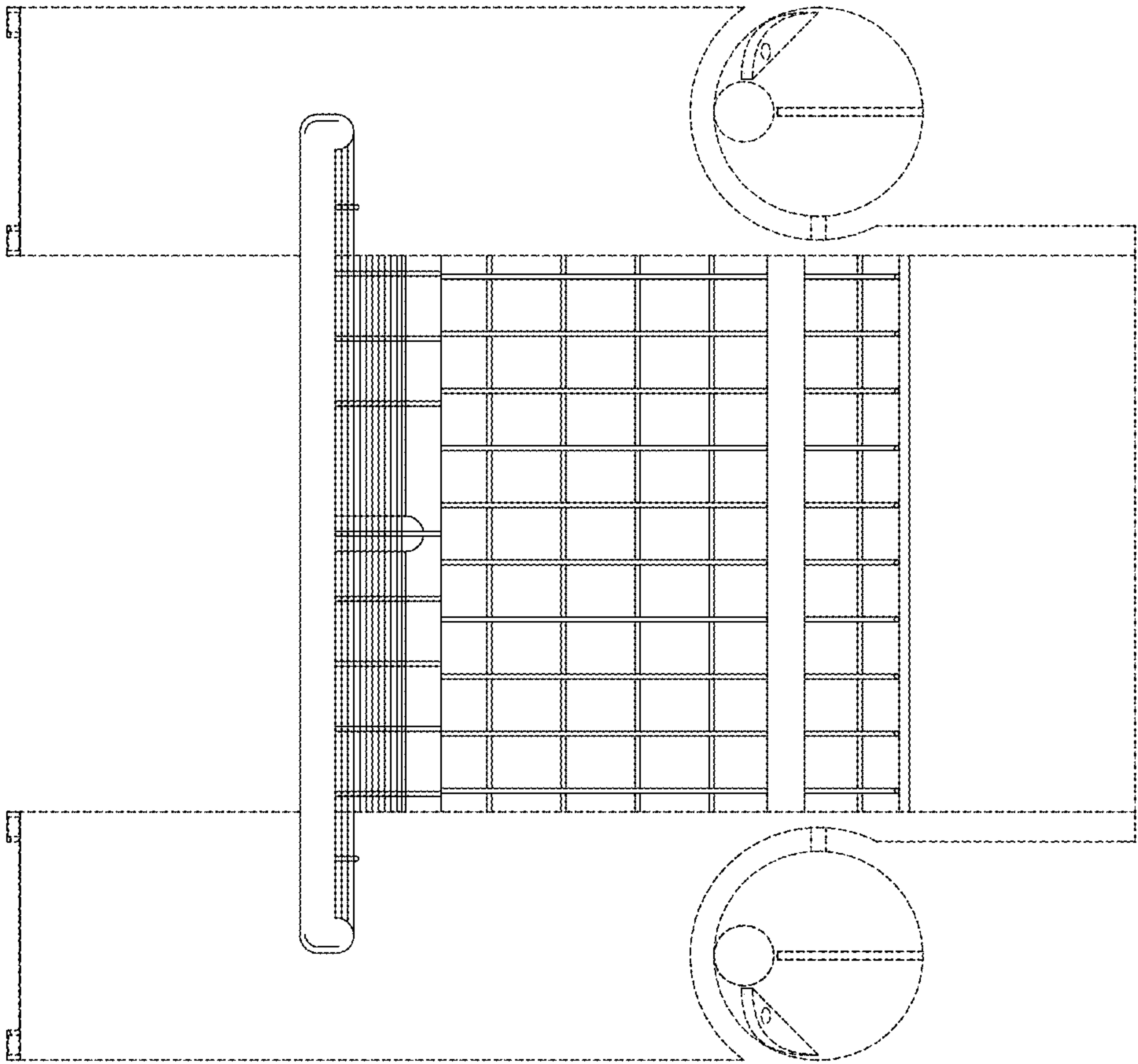

FIG. 6

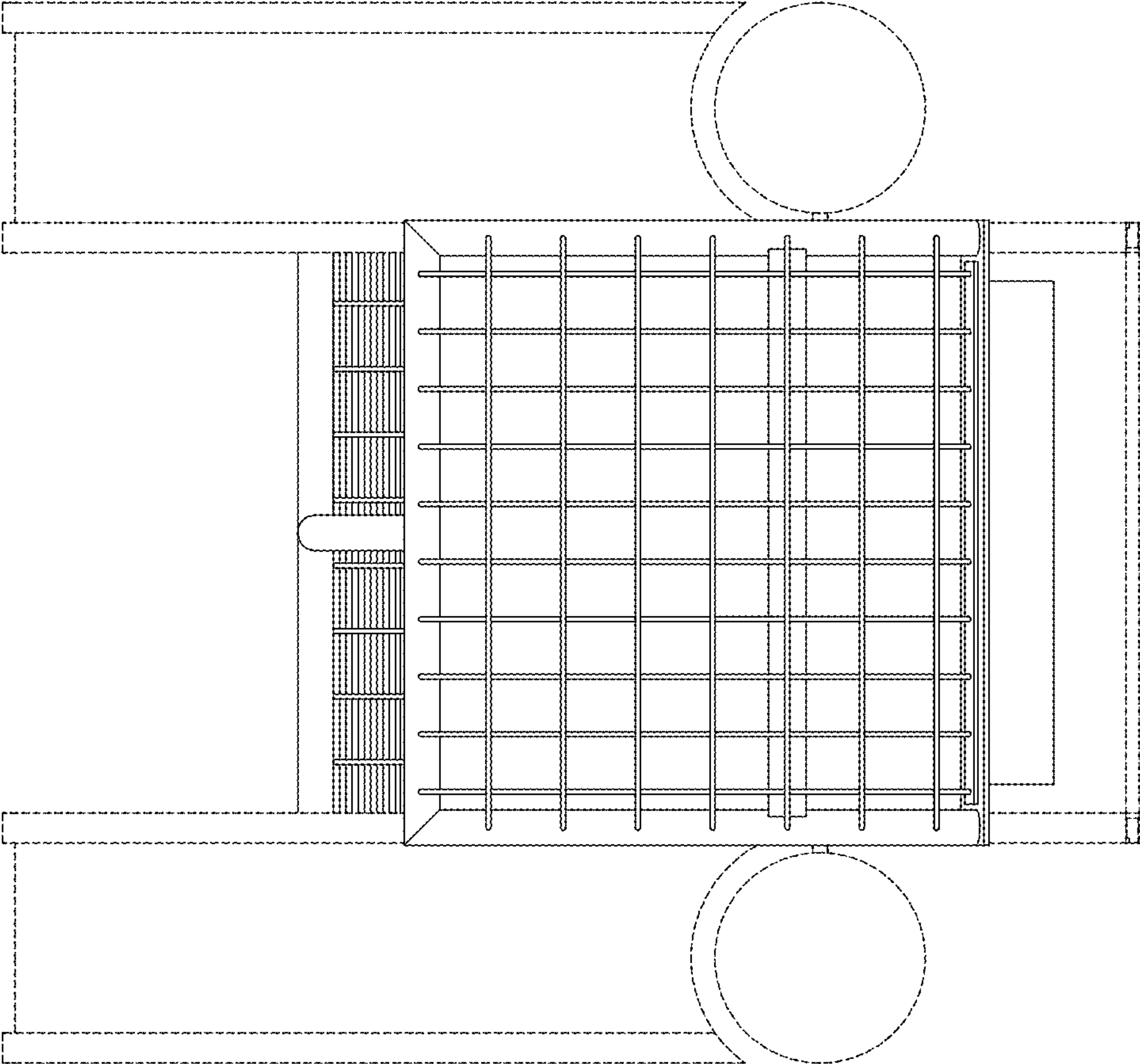

FIG. 7