



US00D910926S

(12) **United States Design Patent** (10) **Patent No.:** **US D910,926 S**
David (45) **Date of Patent:** **** Feb. 16, 2021**

(54) **COMBINATION COSMETIC BRUSH AND CONTAINER**

(71) Applicant: **Maya David**, West Hills, CA (US)

(72) Inventor: **Maya David**, West Hills, CA (US)

(**) Term: **15 Years**

(21) Appl. No.: **29/676,859**

(22) Filed: **Jan. 15, 2019**

(51) **LOC (13) Cl.** **28-03**

(52) **U.S. Cl.**
USPC **D28/77; D28/7; D9/504; D4/116; D4/128**

(58) **Field of Classification Search**
USPC **D28/76-77, 85-90, 7; D9/504, 529; D4/116, 128**
CPC .. **A45D 40/262-268; A45D 2200/1072; A45D 34/042-048; A45D 34/06; A45D 40/18; A46B 5/0008; A46B 9/021; A46B 2200/1046; A46B 2200/1053**
See application file for complete search history.

(56) **References Cited**

U.S. PATENT DOCUMENTS

4,261,376	A *	4/1981	Kingsford	A45D 34/047
					132/218
D263,807	S *	4/1982	Kingsford	D9/504
D406,921	S *	3/1999	Roeder	401/129
D474,341	S *	5/2003	Cantone	A45D 29/007
					D4/116
D482,284	S *	11/2003	Cantone	A45D 29/007
					D9/502
D616,608	S *	5/2010	Maddy	D28/76
8,141,564	B2	3/2012	Cassese		
8,376,641	B2	2/2013	Fraillon		
D702,554	S *	4/2014	Cole	D9/503
9,022,042	B1 *	5/2015	Fichtl	A45D 40/24
					132/218
9,282,804	B2	3/2016	Simonian et al.		

9,301,592	B2 *	4/2016	Hofmann	A45D 40/24
9,439,498	B1 *	9/2016	Eversley	A45D 40/18
D774,910	S *	12/2016	Bracher	D9/504
D795,074	S *	8/2017	Staab	D9/504
D849,416	S *	5/2019	Choi	D4/128
2011/0297174	A1 *	12/2011	Ornoski	A45D 40/262
					132/218
2012/0082502	A1	4/2012	Koguchi		
2020/0069032	A1 *	3/2020	Dempsey	A46B 15/0055
2020/0187634	A1 *	6/2020	Berhault	A45D 40/265
2020/0214422	A1 *	7/2020	Hasegawa	A45D 34/046
2020/0245751	A1 *	8/2020	Thenin	A45D 40/267
2020/0288844	A1 *	9/2020	Diamond	A46B 9/023
2020/0329847	A1 *	10/2020	Bianco	A45D 34/046

* cited by examiner

Primary Examiner — Jennifer Rivard
(74) *Attorney, Agent, or Firm* — Cramer Patent & Design, PLLC; Aaron R. Cramer

(57) **CLAIM**

The ornamental design for a combination cosmetic brush and container, as shown and described.

DESCRIPTION

FIG. 1 is an exploded, top, front, left side perspective view of a combination cosmetic brush and container, showing my new design;
FIG. 2 is an exploded, top, rear, right side perspective view of a combination cosmetic brush and container, showing my new design;
FIG. 3 is an exploded front elevation view thereof;
FIG. 4 is an exploded rear elevation view thereof;
FIG. 5 is a left side elevation view thereof, wherein the right side elevation view is a mirror image thereof; and,
FIG. 6 is an exploded cross-sectional view of the combination cosmetic brush and container taken along line 5-5 in FIG. 5.

1 Claim, 5 Drawing Sheets

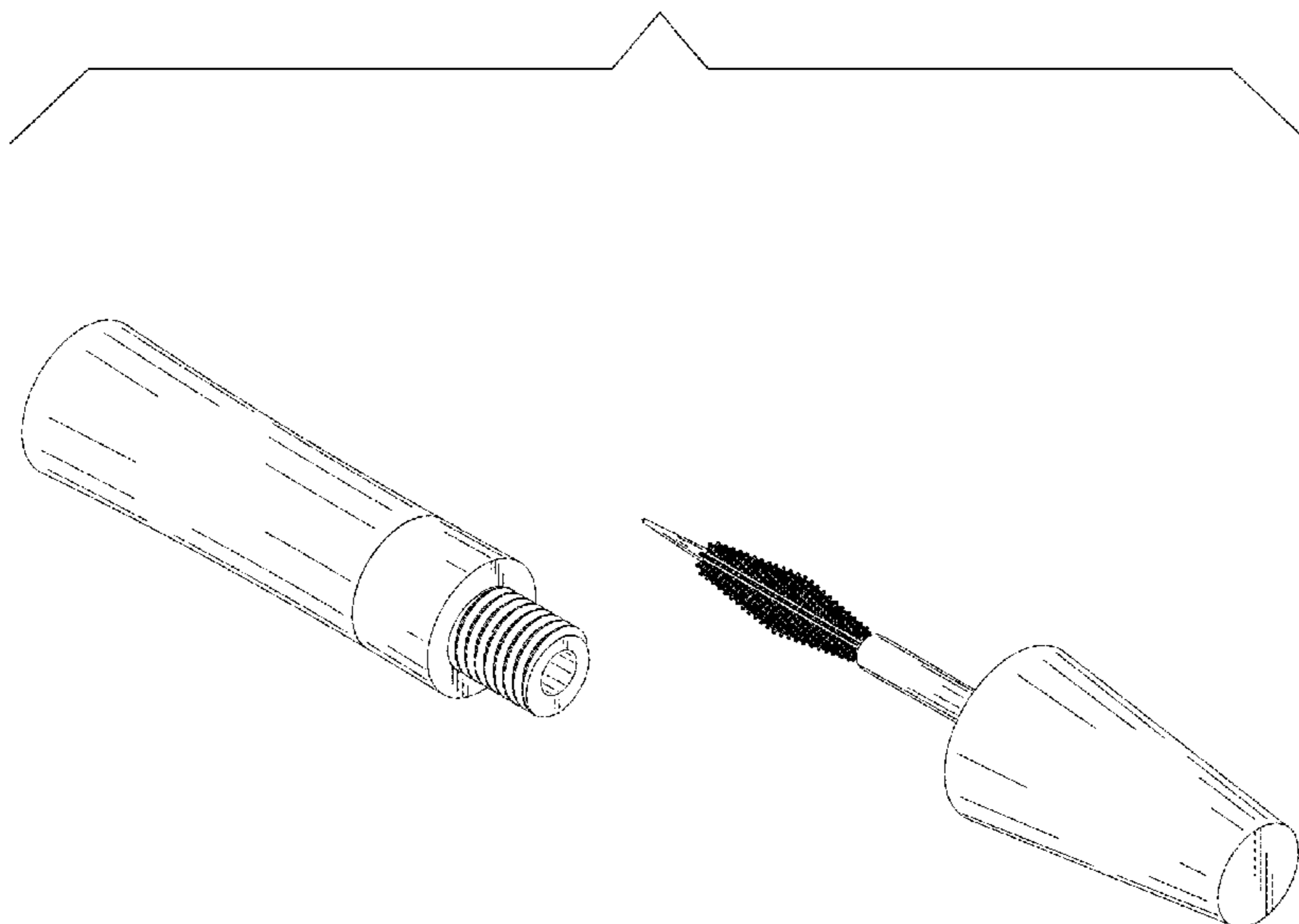

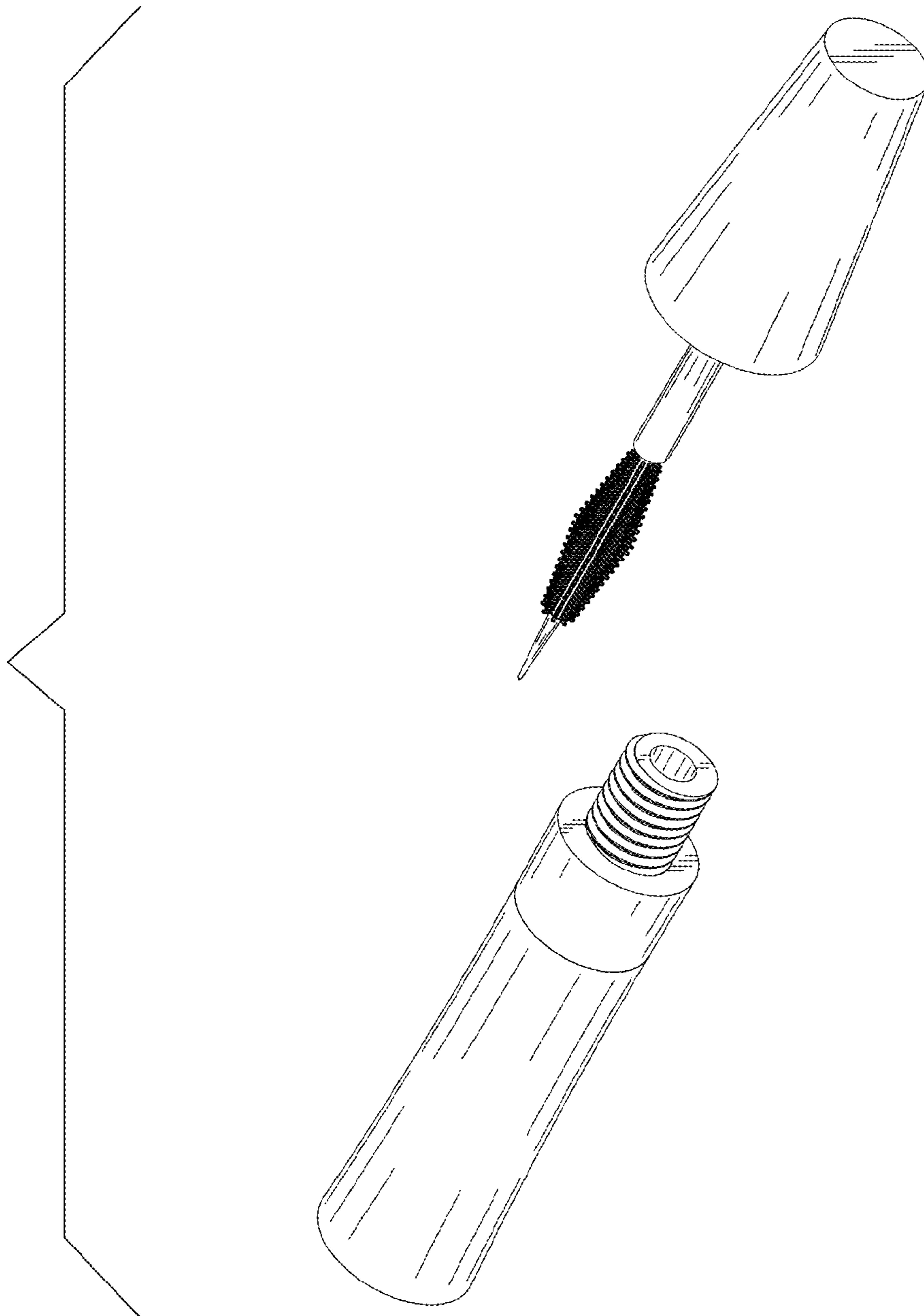

FIG. 1

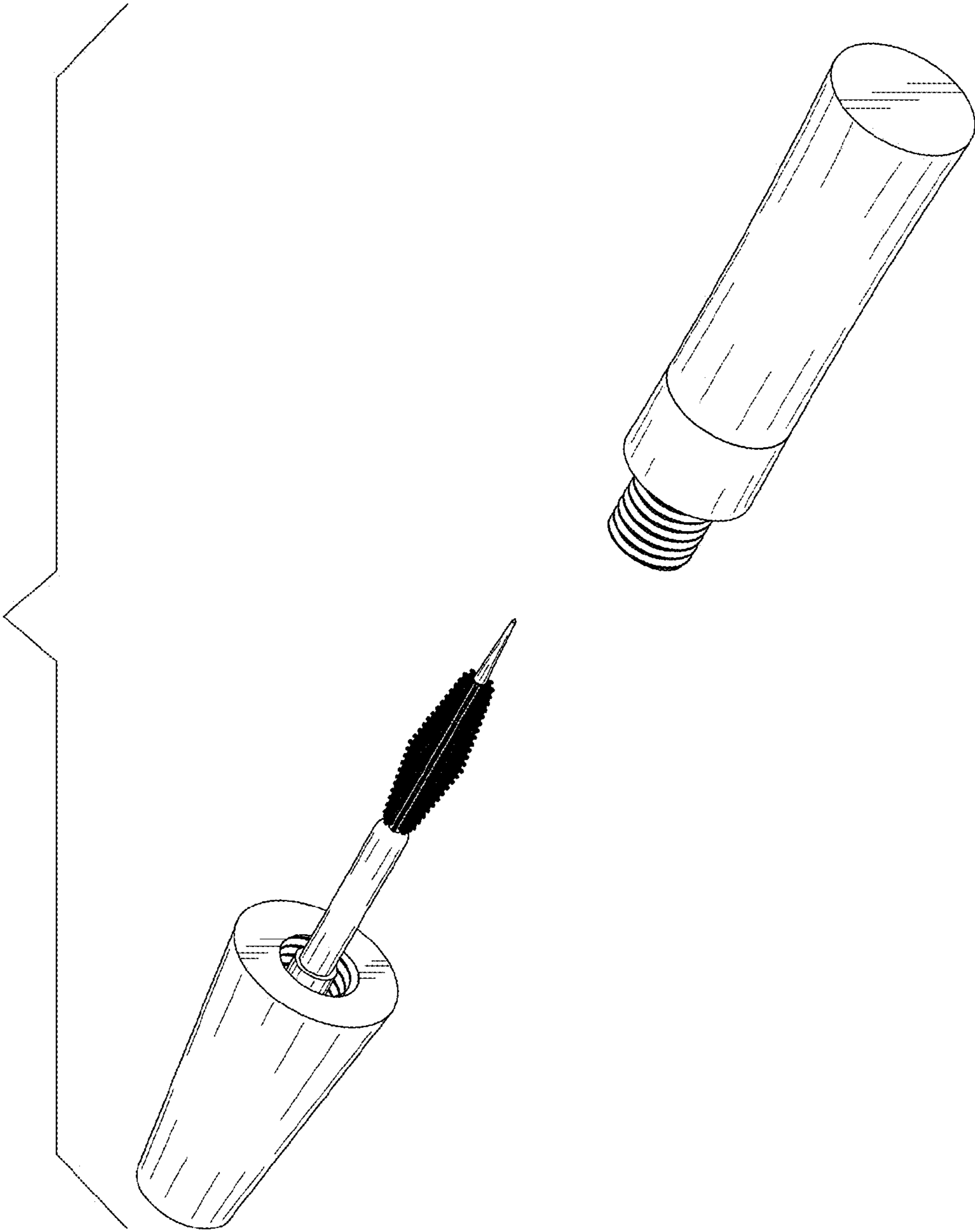

FIG. 2

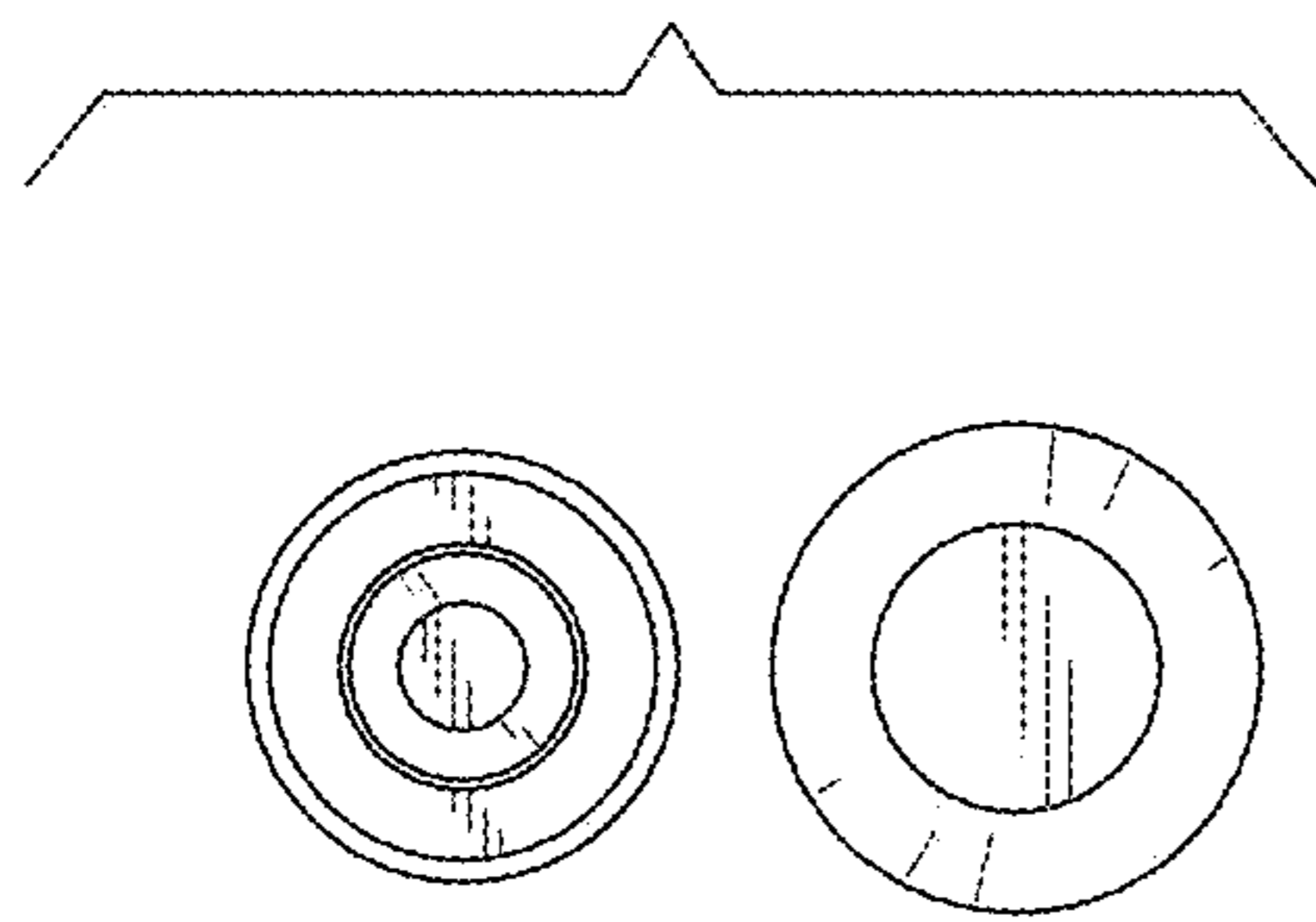

FIG. 3

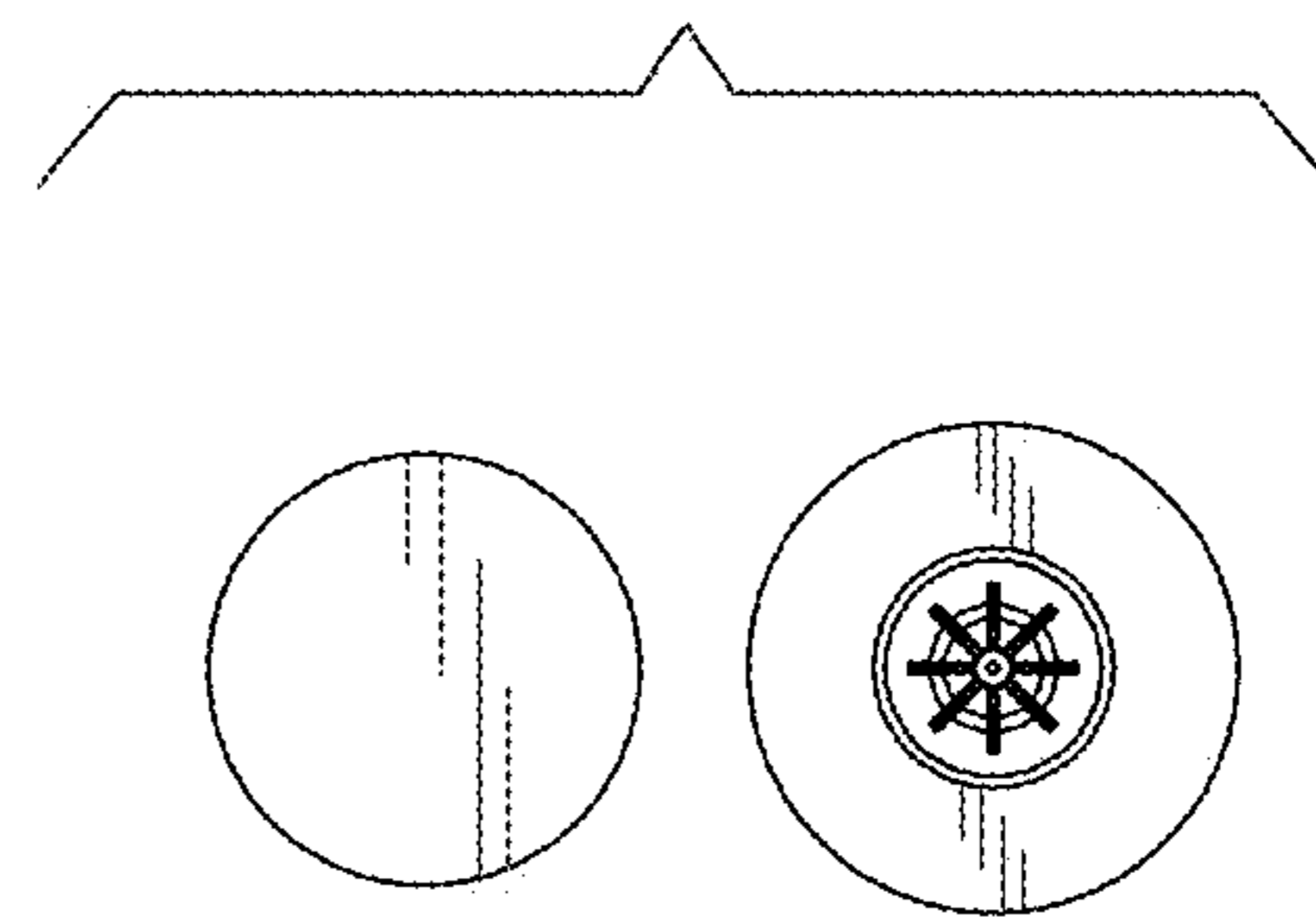

FIG. 4

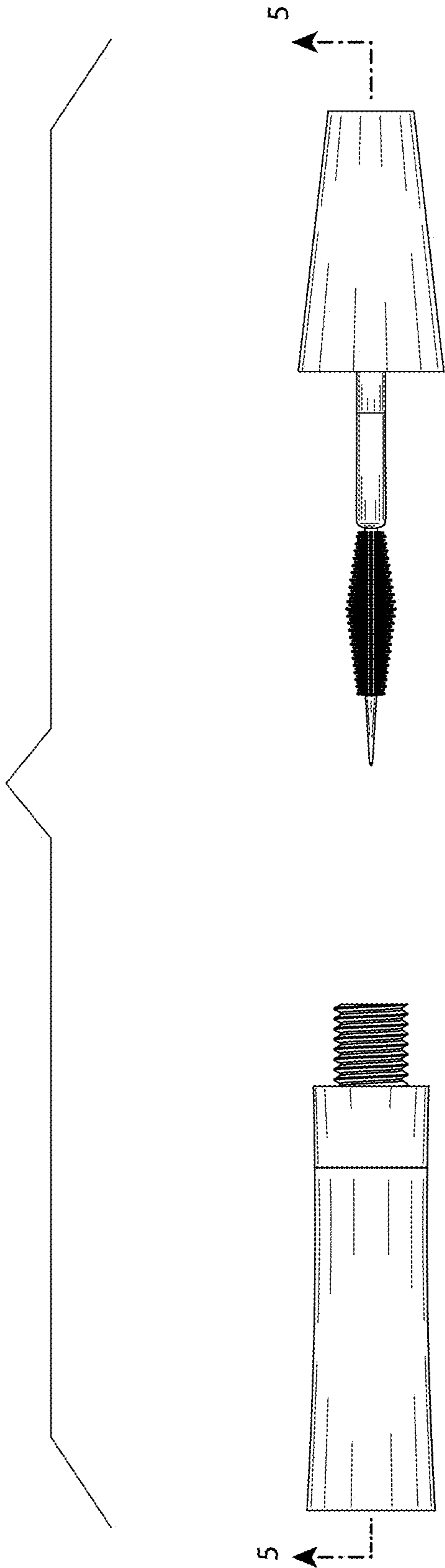

FIG. 5

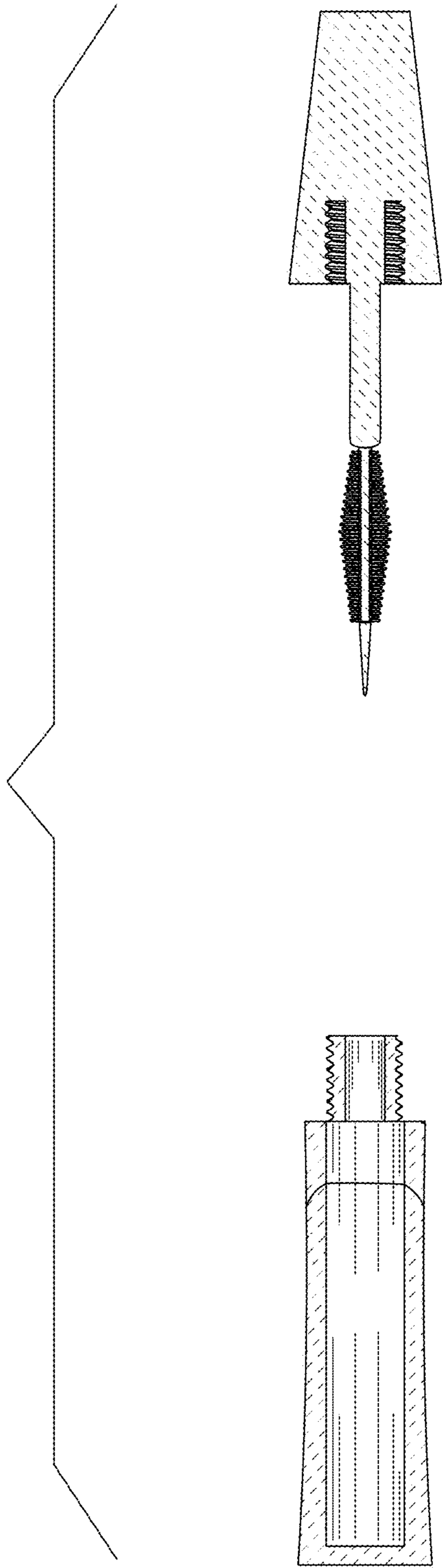

FIG. 6