



US00D910892S

(12) **United States Design Patent** (10) **Patent No.:** **US D910,892 S**
Tanaka et al. (45) **Date of Patent:** **** Feb. 16, 2021**

(54) **FRONT COMBINATION LAMP FOR AN AUTOMOBILE**

(71) Applicant: **Subaru Corporation**, Tokyo (JP)
 (72) Inventors: **Shigeru Tanaka**, Tokyo (JP); **Kohei Kobayashi**, Tokyo (JP)
 (73) Assignee: **Subaru Corporation**, Tokyo (JP)
 (**) Term: **15 Years**

(21) Appl. No.: **29/696,053**

(22) Filed: **Jun. 25, 2019**

(30) **Foreign Application Priority Data**

Dec. 25, 2018 (JP) 2018-028279

(51) **LOC (13) Cl.** **26-06**

(52) **U.S. Cl.**
 USPC **D26/28**

(58) **Field of Classification Search**

USPC D26/28, 29, 30, 31, 32, 33, 34, 35, 36

CPC F21S 48/00; F21S 48/10; F21S 48/115;
 F21S 48/225; F21S 48/1233; F21S
 48/1266; F21S 48/1388; F21S 48/2268;
 F21V 21/04; F21W 2103/35; F21W 3/40;
 F21W 2102/17; F21W 2102/30; F21W
 2103/00; F21W 2103/55; F21W 2104/00;
 F21W 2107/17; F21W 2107/13

See application file for complete search history.

(56) **References Cited**

U.S. PATENT DOCUMENTS

D566,307 S *	4/2008	Hsu	D26/28
D567,970 S *	4/2008	Hsu	D26/28
D582,072 S *	12/2008	Yang	D26/28
D737,484 S *	8/2015	Lai	D26/28
D744,677 S *	12/2015	Lai	D26/28
D831,245 S *	10/2018	Lin	D26/28
D831,246 S *	10/2018	Yang	D26/28
D841,207 S *	2/2019	Yang	D26/28
D853,000 S *	7/2019	Lin	D26/28

* cited by examiner

Primary Examiner — Angela J Lee

(74) *Attorney, Agent, or Firm* — Schiff Hardin LLP

(57) **CLAIM**

The ornamental design for a front combination lamp for an automobile, as shown and described.

DESCRIPTION

FIG. 1 is a front perspective view for a “front combination lamp for an automobile” showing our new design, FIG. 2 is a rear perspective view thereof, FIG. 3 is a front view thereof, FIG. 4 is a rear view thereof, FIG. 5 is a top view thereof, FIG. 6 is a bottom view thereof, FIG. 7 is a left-side view thereof; and, FIG. 8 is a right-side view thereof.

1 Claim, 5 Drawing Sheets

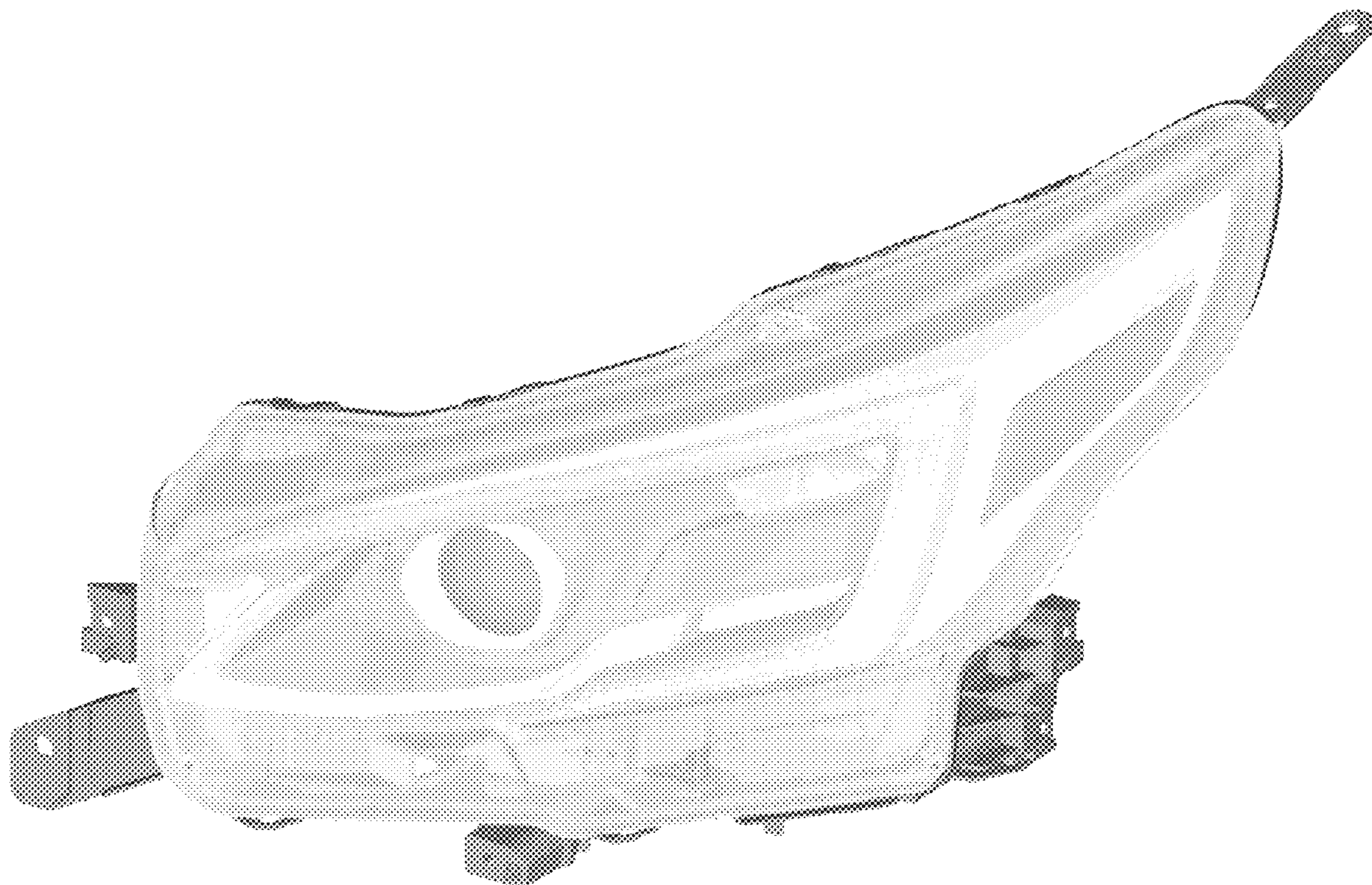

Fig. 1

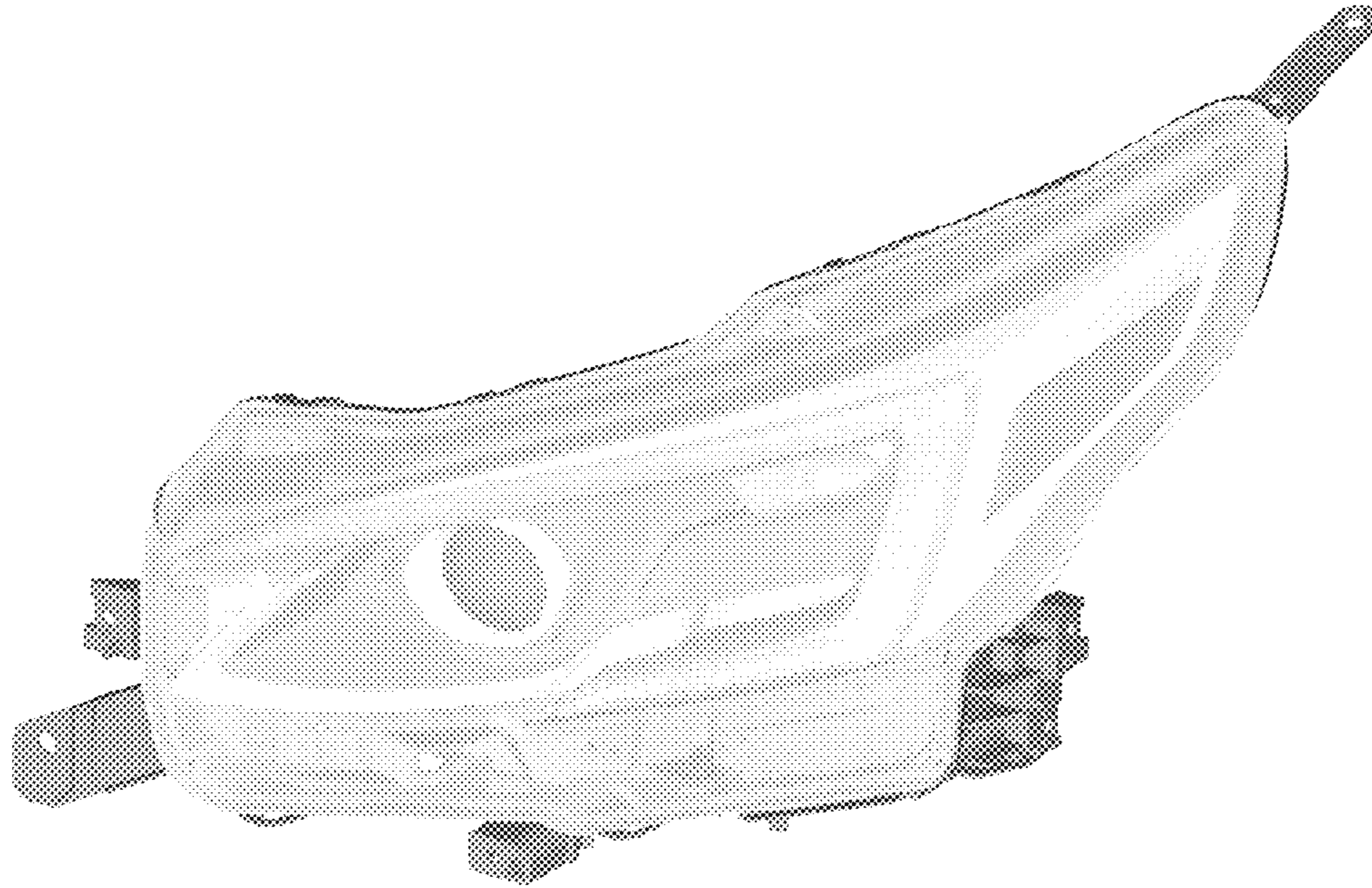

Fig. 2

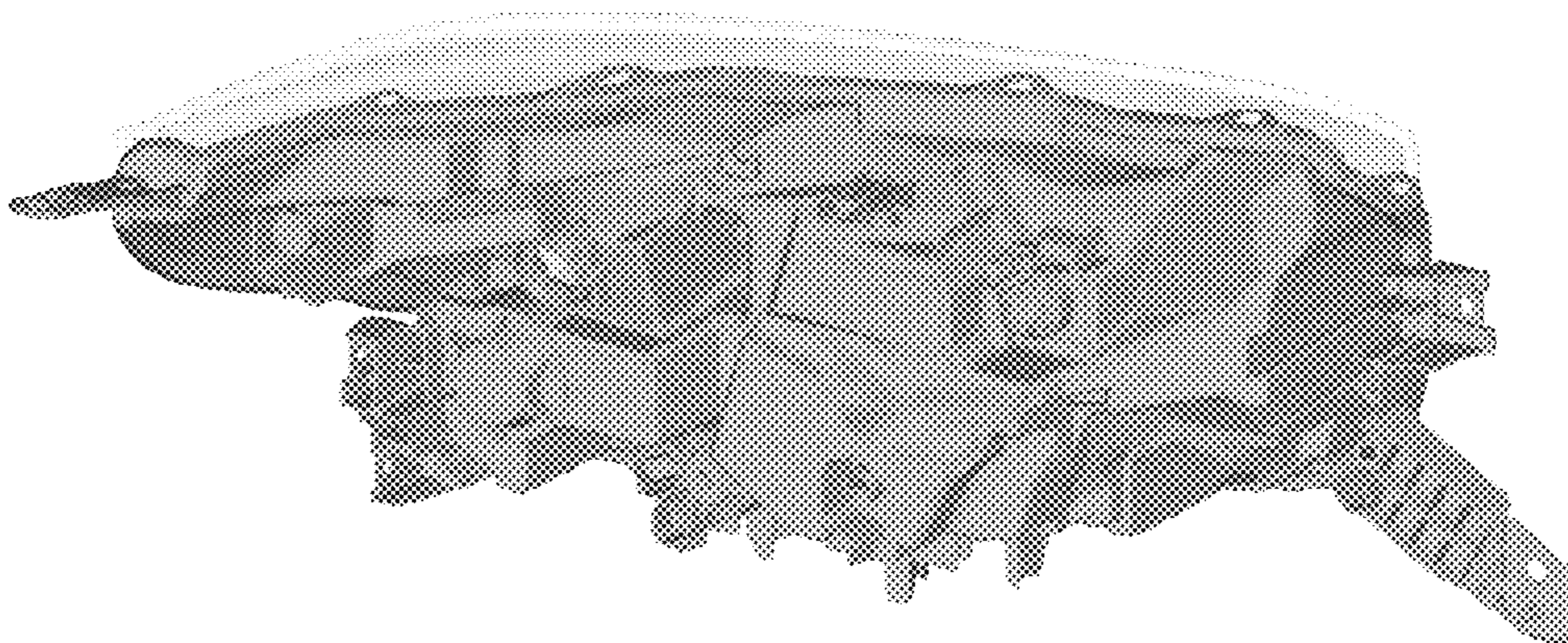

Fig. 3

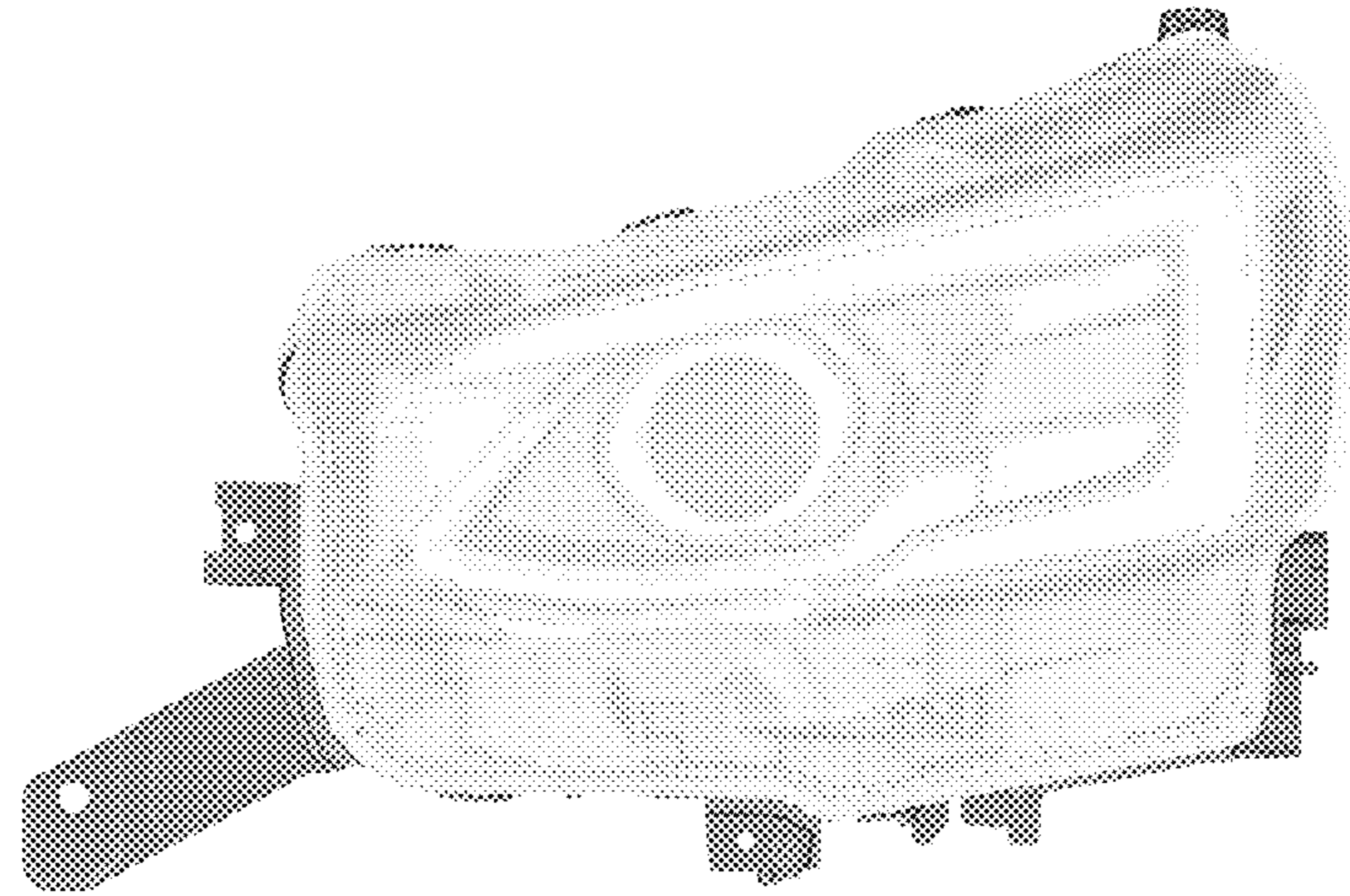

Fig. 4

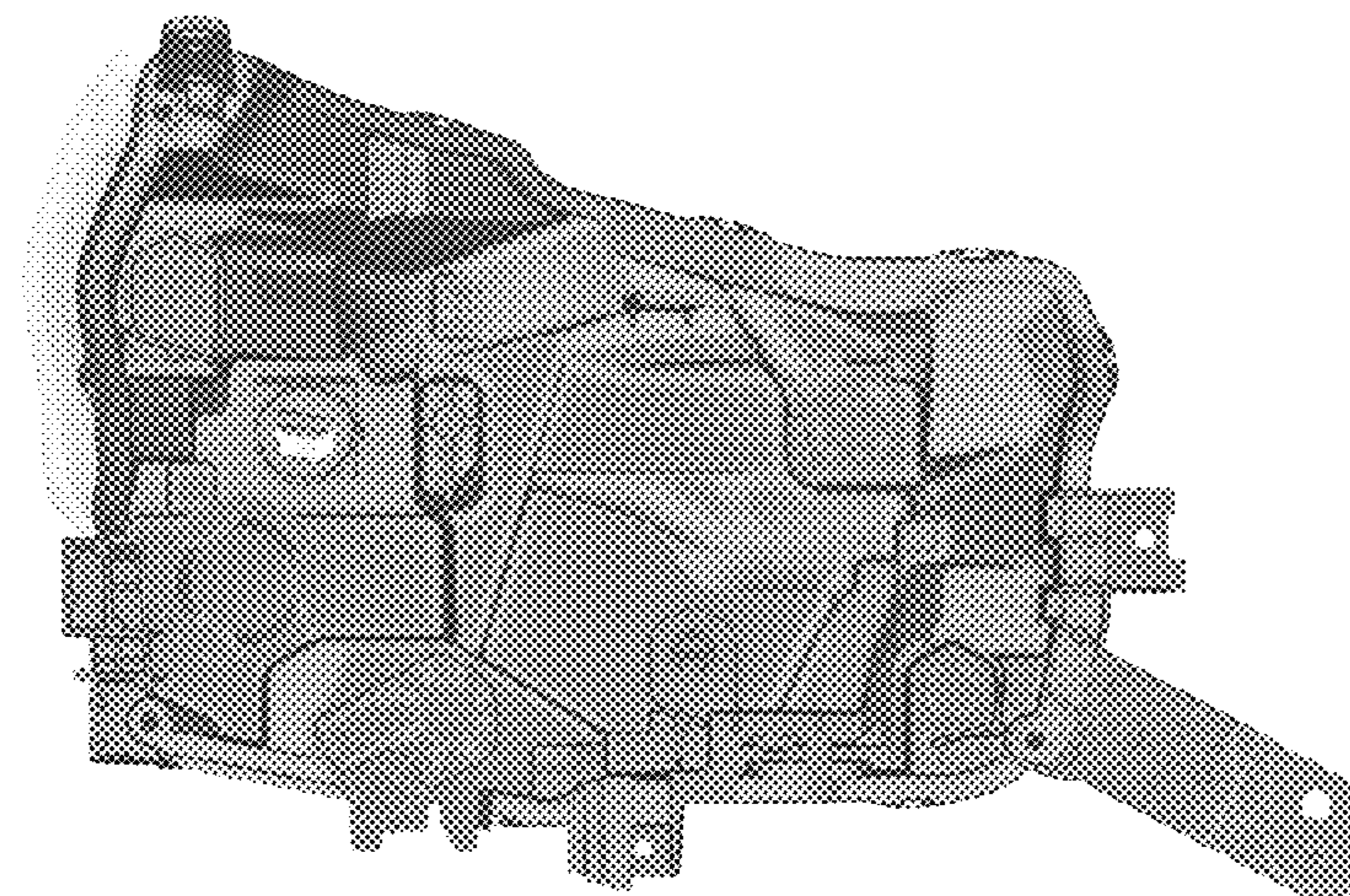

Fig. 5

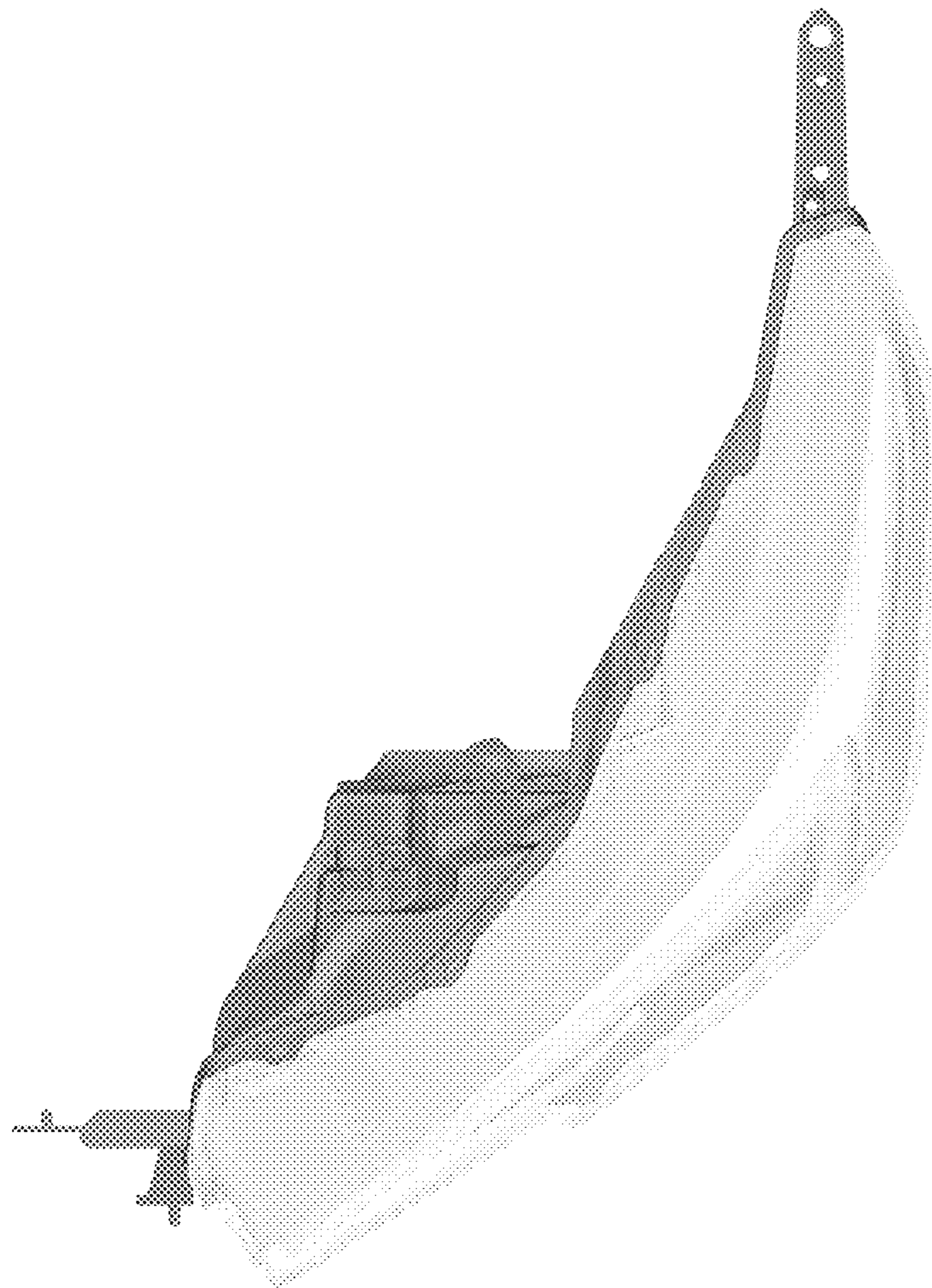

Fig. 6

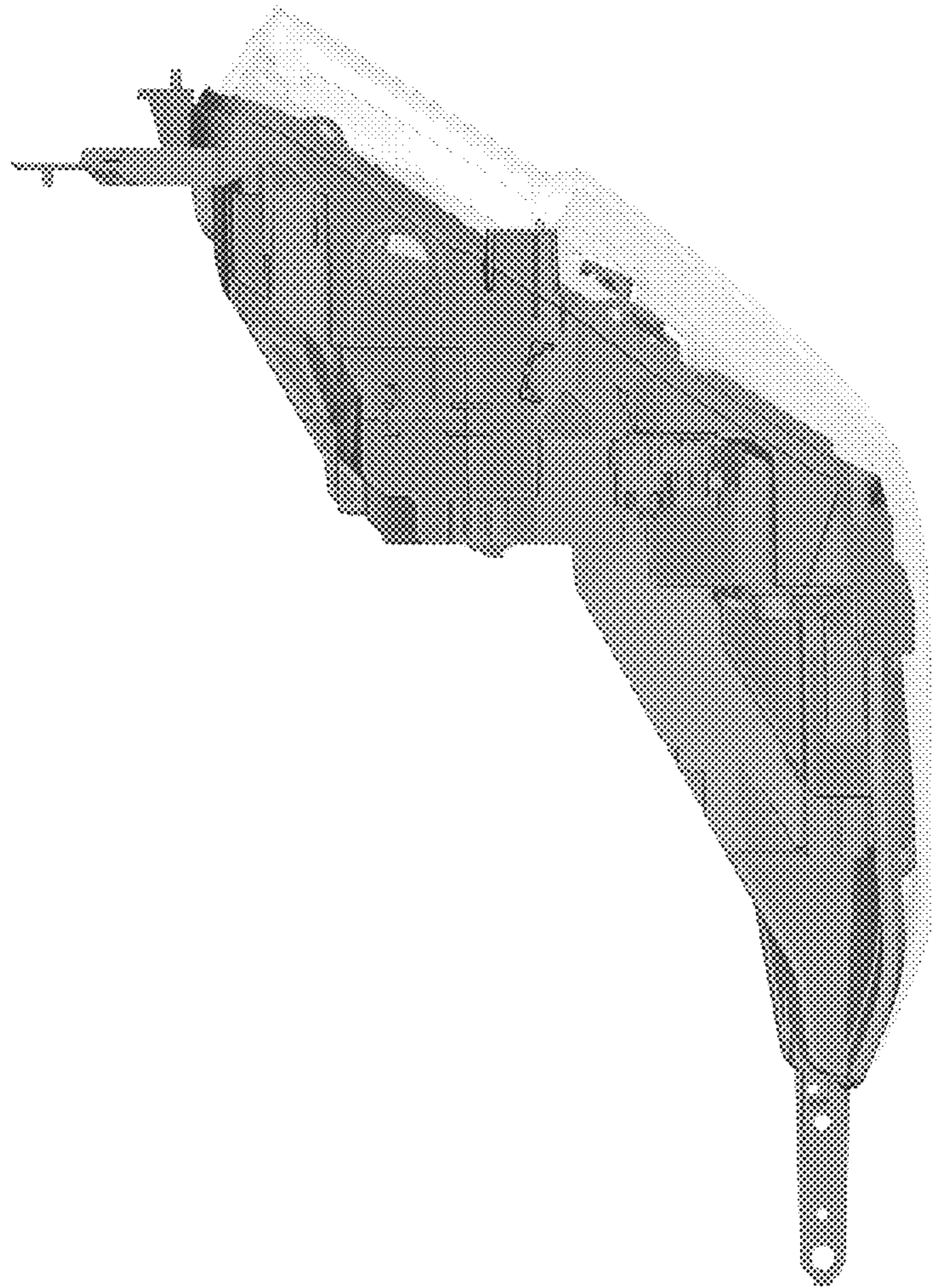

Fig. 7

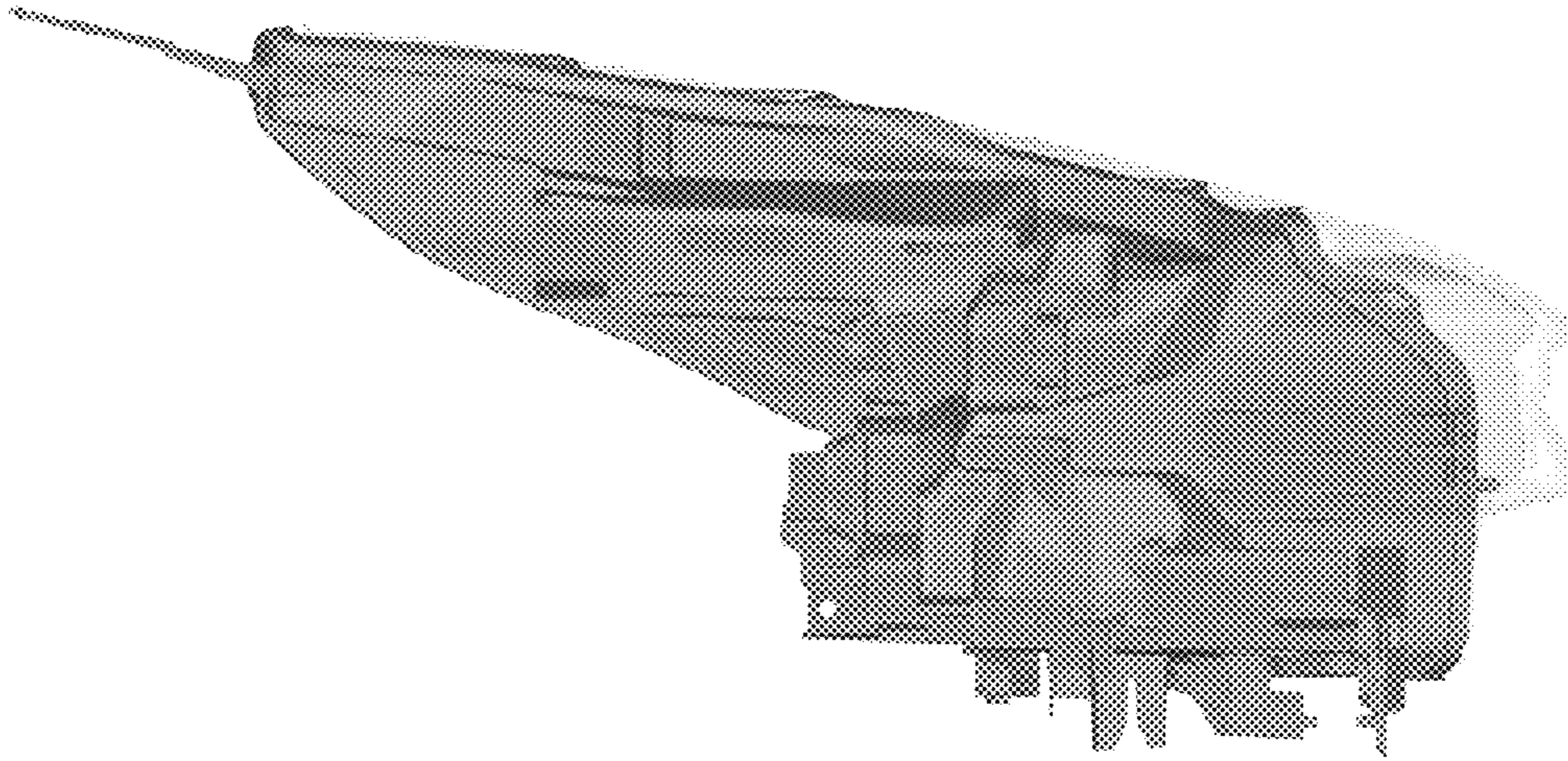

Fig. 8

