



US00D910869S

(12) **United States Design Patent** (10) **Patent No.:** **US D910,869 S**
Xiong (45) **Date of Patent:** **** Feb. 16, 2021**

(54) **EYE MASSAGER**
(71) Applicant: **Shenzhen Hongwang Nicemay Electric Co., Ltd, Shenzhen (CN)**
(72) Inventor: **Shasha Xiong, Shenzhen (CN)**
(73) Assignee: **SHENZHEN HONGWANG NICEMAY ELECTRIC CO., LTD, Shenzhen (CN)**
(**) Term: **15 Years**
(21) Appl. No.: **29/684,414**
(22) Filed: **Mar. 20, 2019**
(30) **Foreign Application Priority Data**
Oct. 11, 2018 (CN) 201830567596.2
(51) **LOC (13) Cl.** **28-03**
(52) **U.S. Cl.**
USPC **D24/215**
(58) **Field of Classification Search**
USPC D24/119, 133, 141, 172, 200, 211, 212, D24/213, 214, 215
CPC A61H 19/34; A61H 19/40; A61H 21/00; A61H 19/30; A61H 19/44; A61H 19/00; A61H 2205/024
See application file for complete search history.

(56) **References Cited**
U.S. PATENT DOCUMENTS
D386,879 S * 11/1997 Daniels D24/214
D475,793 S * 6/2003 Tinsley D24/214
D540,952 S * 4/2007 Colvin D24/215
D589,619 S * 3/2009 Wu D24/133
D608,890 S * 1/2010 Takashima D24/141
D633,625 S * 3/2011 Maderazzo D24/200
D643,128 S * 8/2011 Mohamed D24/215
D648,442 S * 11/2011 Caggiano D24/215
D652,943 S * 1/2012 Chong D24/215

D668,346 S * 10/2012 Zeng D24/215
D685,105 S * 6/2013 Marshall D24/215
D687,957 S * 8/2013 Heskier D24/215
D688,382 S * 8/2013 Marshall D24/215
D696,414 S * 12/2013 Tabe D24/215
D698,452 S * 1/2014 Tai D24/215
D706,440 S * 6/2014 Hahr D24/215
D706,441 S * 6/2014 Hahr D24/215
D720,862 S * 1/2015 McDonald, Jr. D24/215
D722,698 S * 2/2015 Frankel D24/171
D744,663 S * 12/2015 Holland D24/211
D750,797 S * 3/2016 Mannheim D24/215
D754,395 S * 4/2016 Yeo D28/7
D758,600 S * 6/2016 Matsushita D24/200
D793,555 S * 8/2017 Dupre D24/141
D822,201 S * 7/2018 Decker D24/119
(Continued)

OTHER PUBLICATIONS

Nicemay, "Solar Energy Face Uplifting Massager", Dec. 24, 2020. <https://www.nicemay.com/facial-body-shaping/267.html>. Shown on p. 1. (Year: 2020).*
Primary Examiner — Cynthia Ramirez
Assistant Examiner — Michael A Maharajh

(57) **CLAIM**
The ornamental design for an eye massager, as shown and described.

DESCRIPTION

FIG. 1 is a perspective view of an eye massager showing my new design;
FIG. 2 is another perspective view thereof;
FIG. 3 is a front elevational view thereof;
FIG. 4 is a rear elevational view thereof;
FIG. 5 is a left side elevational view thereof;
FIG. 6 is a right side elevational view thereof;
FIG. 7 is a top plan view thereof; and,
FIG. 8 is a bottom plan view thereof.

1 Claim, 8 Drawing Sheets

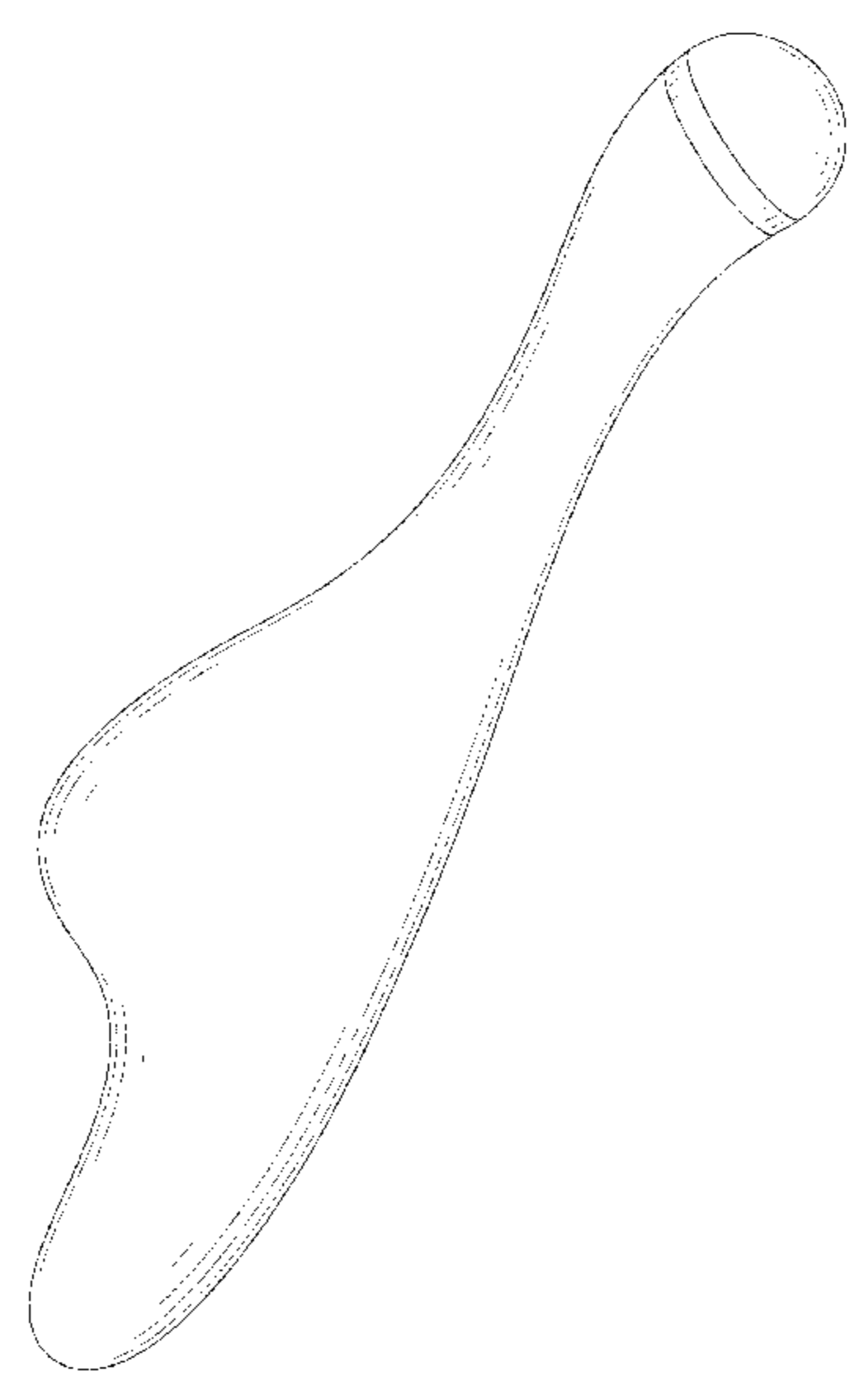

(56)

References Cited

U.S. PATENT DOCUMENTS

D826,421 S *	8/2018	Janapol	D24/215
D833,637 S *	11/2018	Marshall	D24/215
D839,441 S *	1/2019	Harashima	D24/215
D866,781 S *	11/2019	Maroney	D24/200
D878,615 S *	3/2020	Ankosko	D24/200
D886,319 S *	6/2020	Sugimoto	D24/215
D894,418 S *	8/2020	Paterson	D24/214
D899,616 S *	10/2020	Jung	D24/215
D905,233 S *	12/2020	Clute	D24/119

* cited by examiner

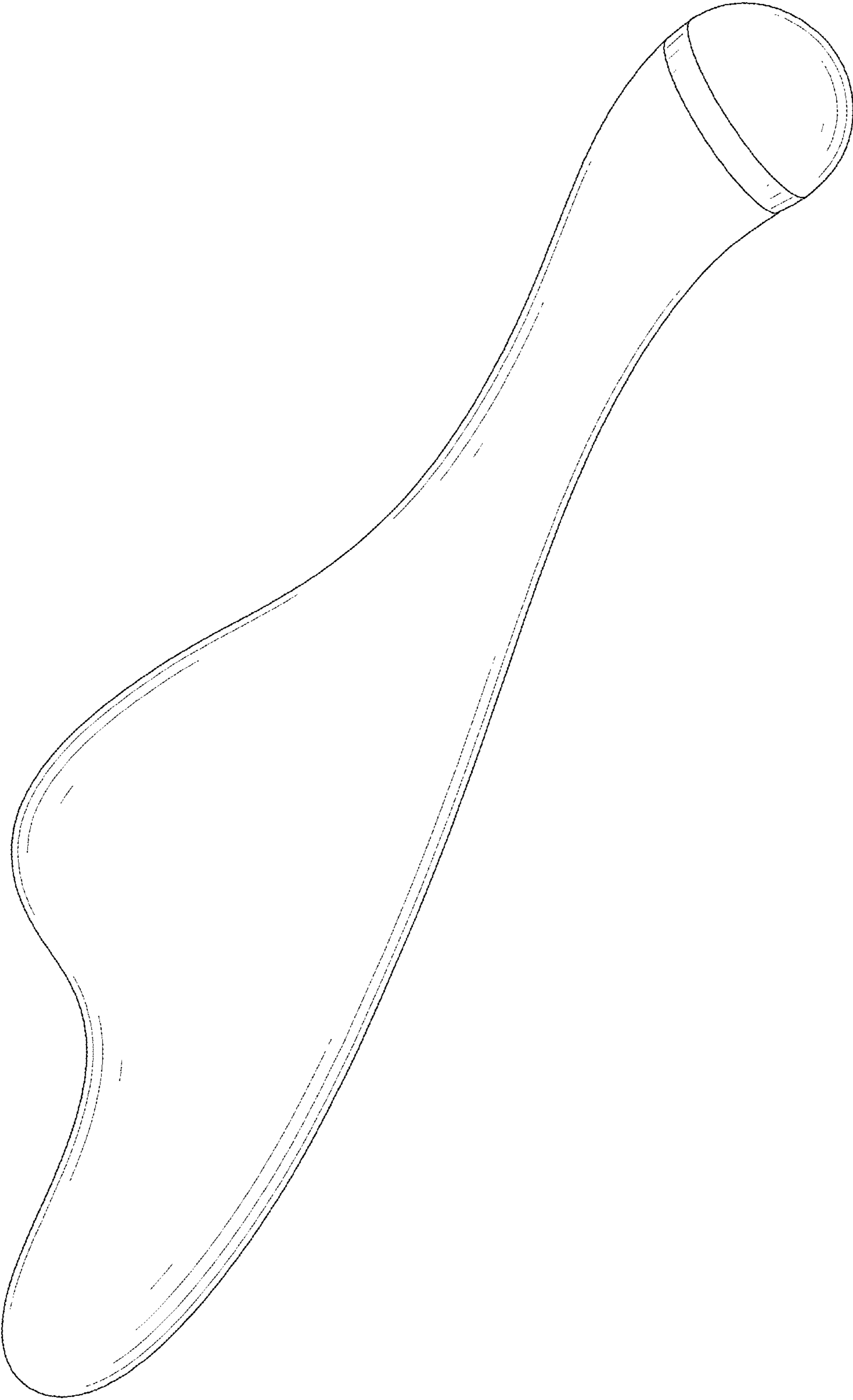

FIG. 1

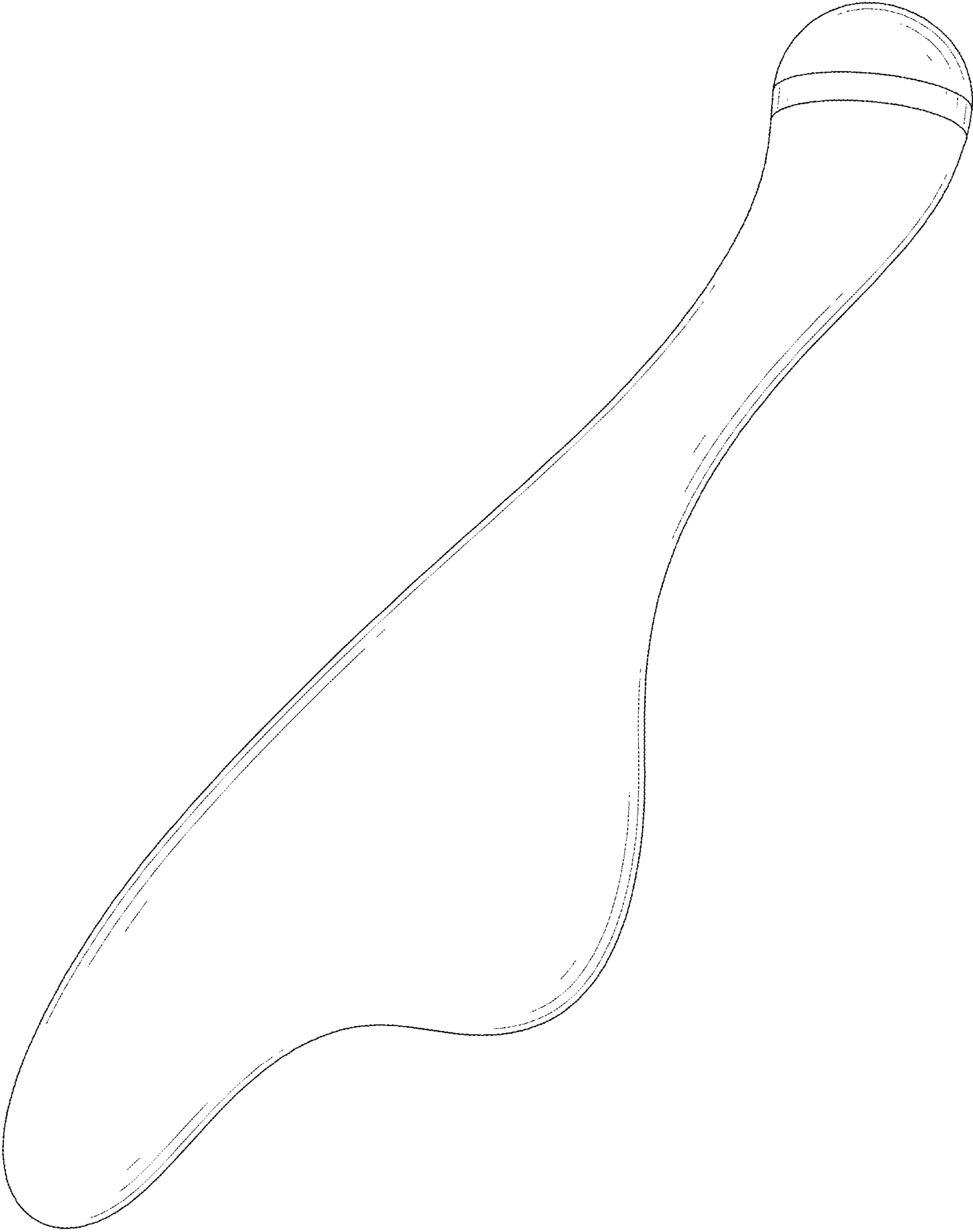

FIG. 2

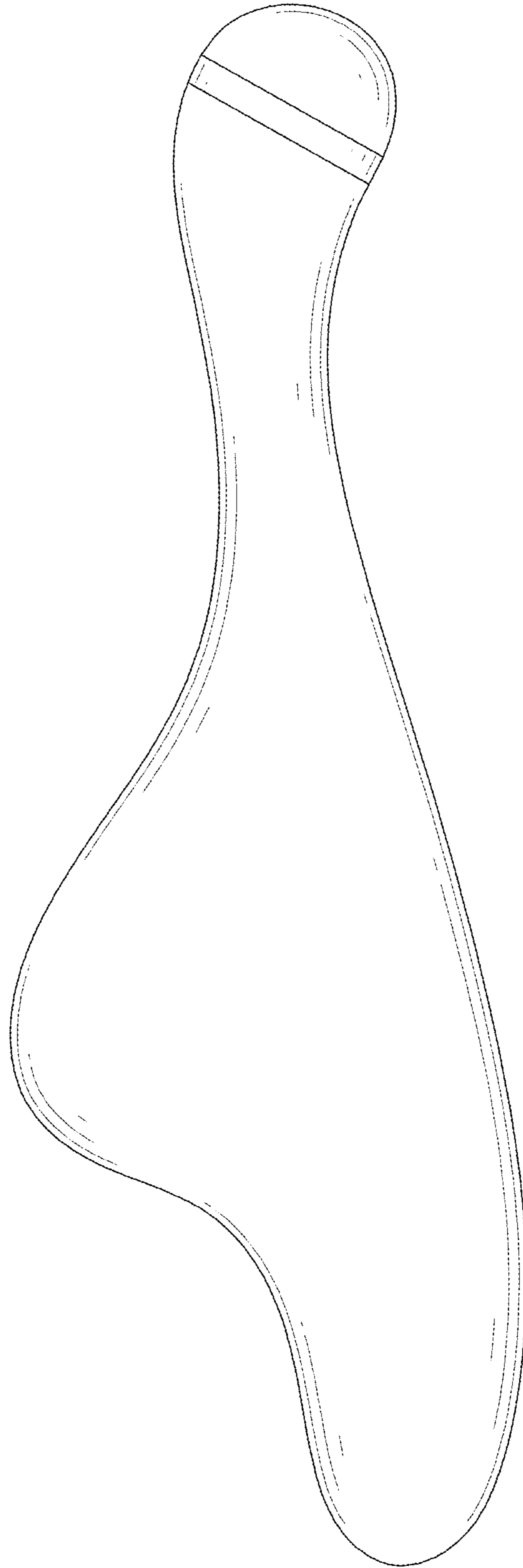

FIG. 3

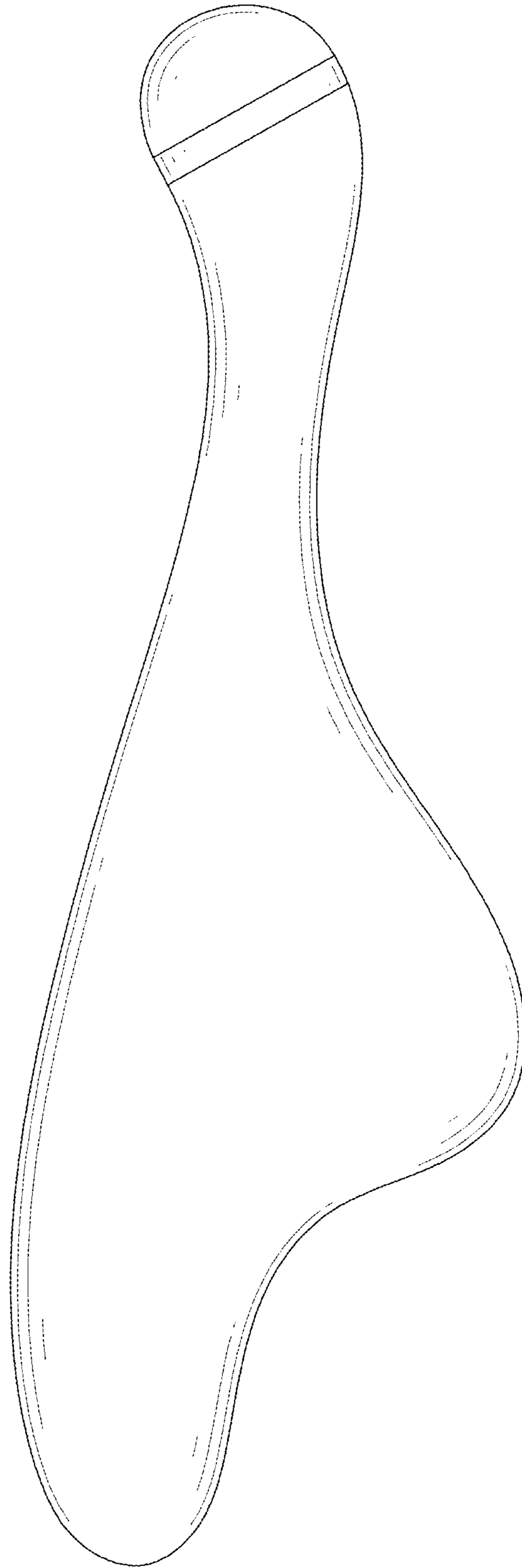

FIG. 4

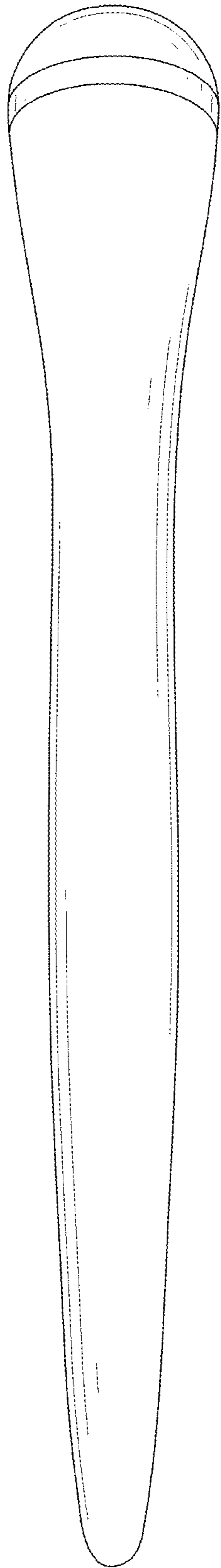

FIG. 5

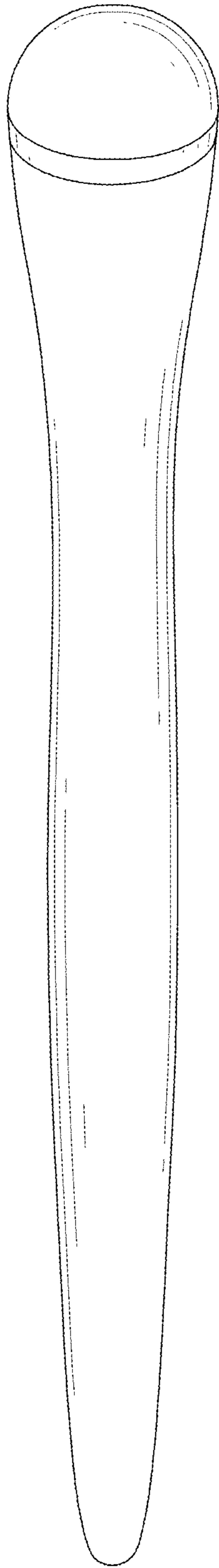

FIG. 6

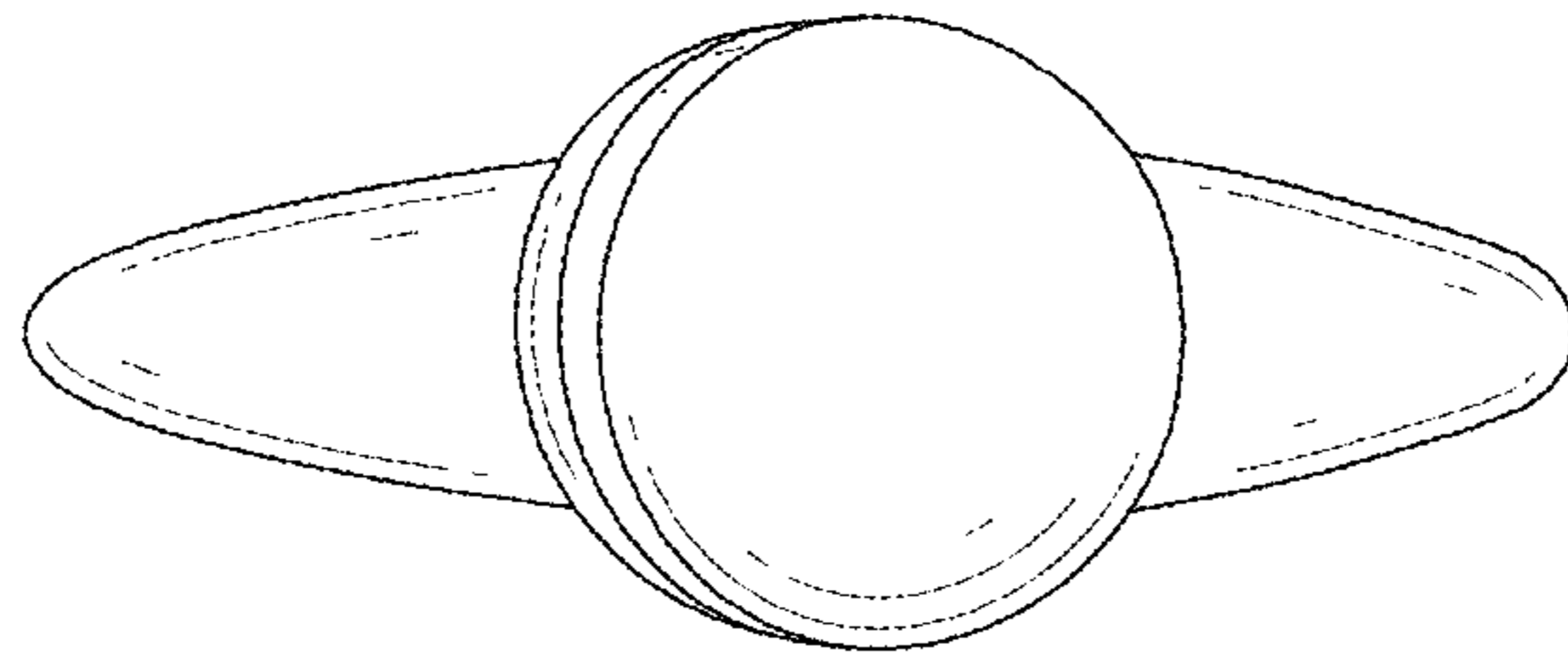

FIG. 7

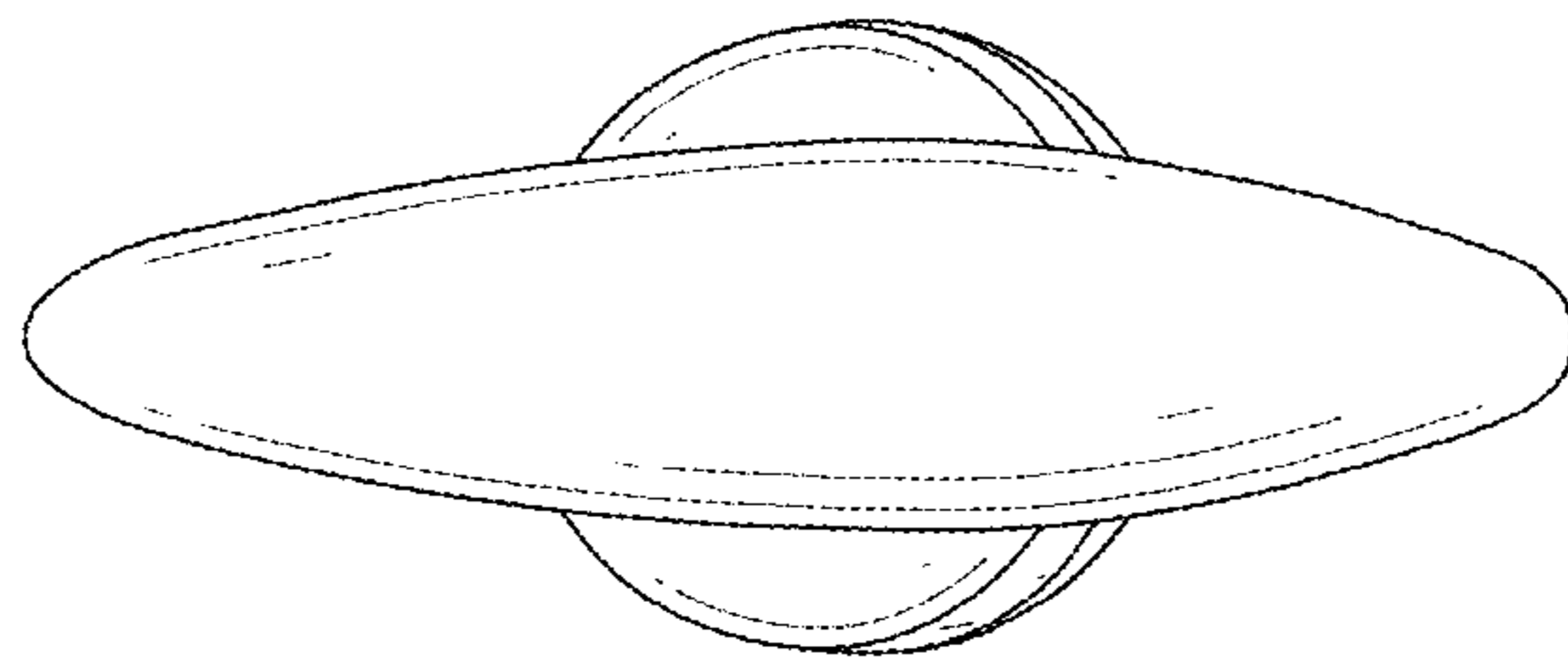

FIG. 8