



US00D910833S

(12) **United States Design Patent**
Trout et al.

(10) **Patent No.:** **US D910,833 S**

(45) **Date of Patent:** **** Feb. 16, 2021**

(54) **RESTRICTOR BLOCK FOR A FAN MOUNT**

(71) Applicant: **DELTA T, LLC**, Lexington, KY (US)

(72) Inventors: **Chris Trout**, Lexington, KY (US);
Ethan Beum, Lexington, KY (US);
Preston Goulson, Lexington, KY (US)

(73) Assignee: **DELTA T, LLC**, Lexington, KY (US)

(**) Term: **15 Years**

(21) Appl. No.: **29/668,870**

(22) Filed: **Nov. 2, 2018**

(51) **LOC (13) Cl.** **23-03**

(52) **U.S. Cl.**
USPC **D23/411**

(58) **Field of Classification Search**
USPC D23/411, 370, 314, 358, 363, 386, 499;
D8/349, 354, 363, 373, 376, 380, 382,
D8/383; D10/96
CPC F16M 13/02; F04D 29/64; F04D 29/646;
F04D 29/601
See application file for complete search history.

(56) **References Cited**

U.S. PATENT DOCUMENTS

5,234,119	A *	8/1993	Jorgensen	H02G 3/20 220/3.9
D380,663	S *	7/1997	Nakamura	D8/354
D417,611	S *	12/1999	van de Lande	D8/356
D490,293	S *	5/2004	Brown	D8/354
D525,181	S *	7/2006	Horner	D12/180
D539,639	S *	4/2007	Nagle	D8/396
H002203	H *	10/2007	Borchardt	D8/396
D578,390	S *	10/2008	Green	D9/440
7,510,160	B1 *	3/2009	Wang	F04D 29/601 248/288.31
D603,878	S *	11/2009	Chu	D15/9
7,621,498	B2 *	11/2009	Tang	F04D 29/60 248/317

D635,237	S *	3/2011	Fizer	D23/377
D641,075	S *	7/2011	Fizer	D23/411
D649,864	S *	12/2011	Symons	D8/356
8,317,210	B1 *	11/2012	Ryshavy	B60G 15/067 280/124.1
8,353,675	B2 *	1/2013	Lin	F04D 29/601 416/244 R
D677,558	S *	3/2013	Frandsen	F16L 3/222 D8/356
D690,001	S *	9/2013	McNulty	D23/383

(Continued)

OTHER PUBLICATIONS

Notice of Allowance dated Aug. 3, 2020 for U.S. Appl. No. 16/178,807, filed Nov. 2, 2018.

Primary Examiner — Marie D. Fast Horse

(74) *Attorney, Agent, or Firm* — King & Schickli, PLLC

(57) **CLAIM**

The ornamental design for a restrictor block for a fan mount, as shown and described.

DESCRIPTION

FIG. 1 is a top perspective view of a restrictor block for a fan mount showing our new design; FIG. 2 is a bottom perspective view of the restrictor block; FIG. 3 is a front view of the restrictor block; FIG. 4 is a right side view of the restrictor block; FIG. 5 is a rear view of the restrictor block; FIG. 6 is a left side view of the restrictor block; FIG. 7 is a top view of the restrictor block; and, FIG. 8 is a bottom view of the restrictor block.

The restrictor block for a fan mount is shown with a symbolic break in its height. The appearance of any portion of the article between the break lines forms no part of the claimed design. The broken dashed lines in the drawings depict portions of the restrictor block for a fan mount that form no part of the claim.

1 Claim, 6 Drawing Sheets

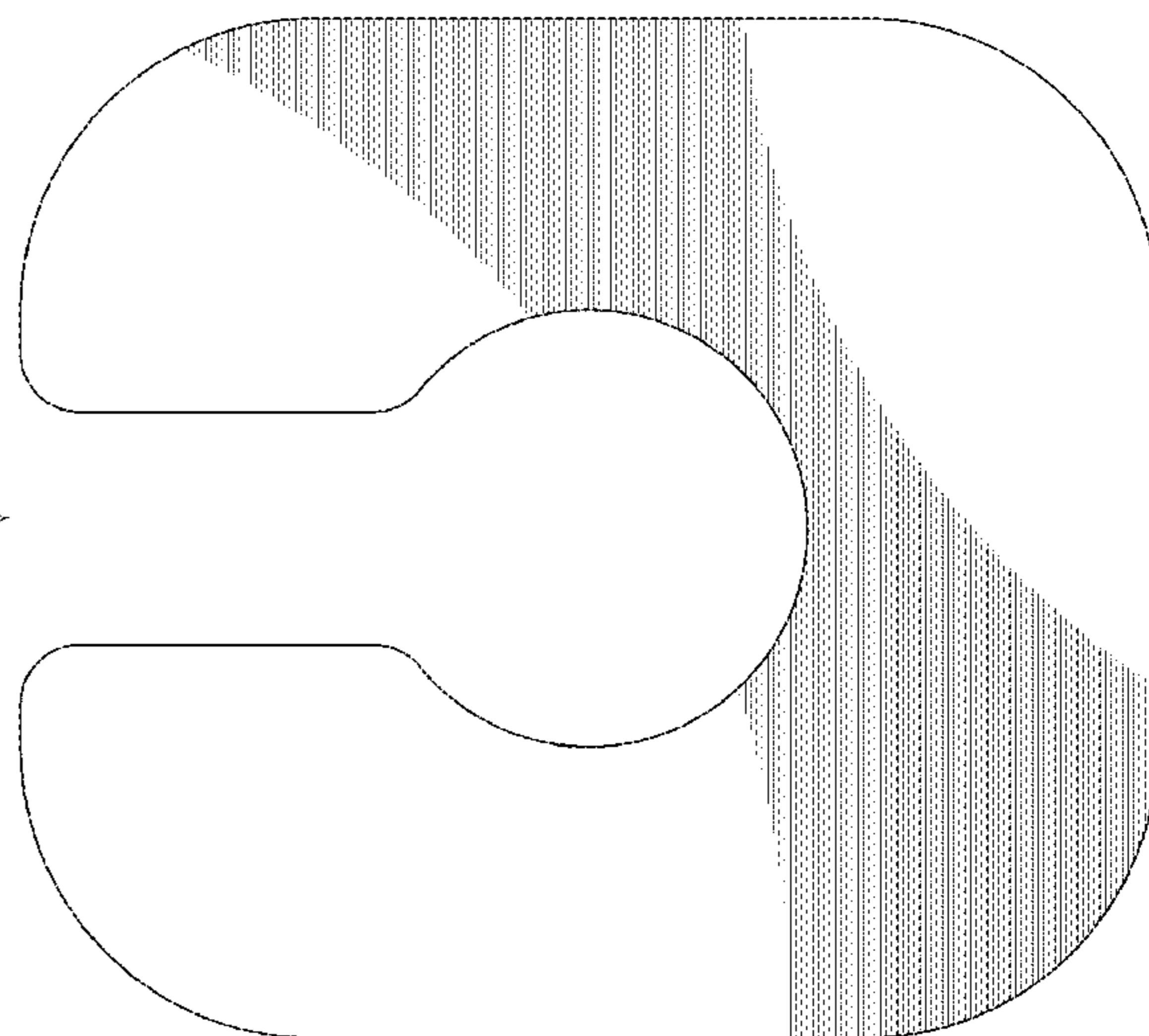
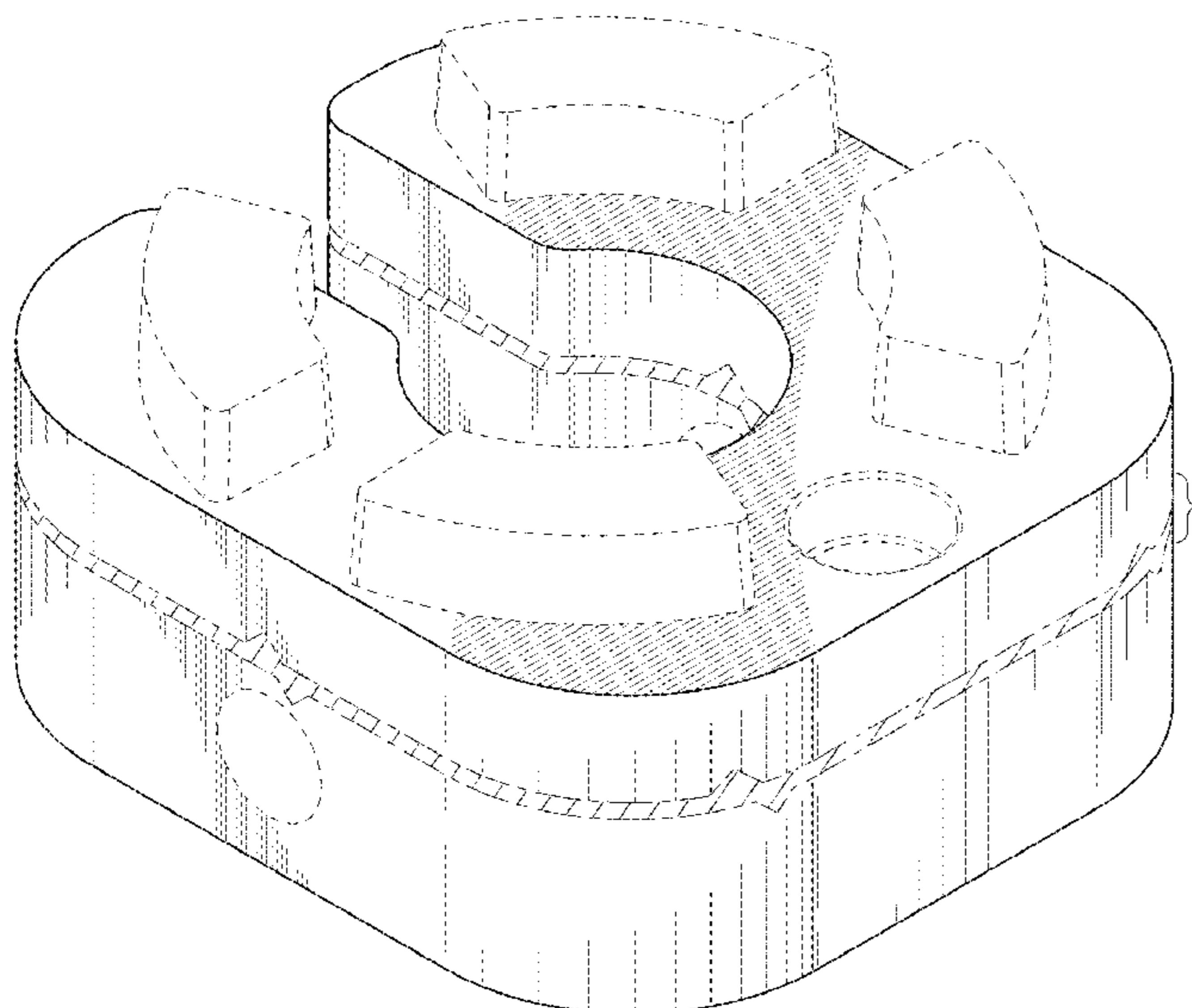

(56)

References Cited

U.S. PATENT DOCUMENTS

D691,877 S * 10/2013 Ganski D8/356
 D691,878 S * 10/2013 Ganski D8/356
 D704,818 S * 5/2014 Allen D23/411
 D739,505 S * 9/2015 Jones D23/259
 D743,044 S * 11/2015 Jackson D24/129
 D750,467 S * 3/2016 Hill D8/349
 D750,535 S * 3/2016 Ryshavy D12/159
 D766,703 S * 9/2016 Hill D8/354
 D775,933 S * 1/2017 Hill D8/354
 D775,934 S * 1/2017 Hill D8/354
 D805,370 S * 12/2017 Ng D8/356
 D817,153 S * 5/2018 Harogolige Padmanabha
 D8/356
 D840,795 S * 2/2019 Tribbett B65D 63/16
 D8/383
 D865,941 S * 11/2019 Beaman D23/411

2004/0005218 A1* 1/2004 Marshall F04D 25/088
 416/146 R
 2004/0062656 A1* 4/2004 Marshall F04D 25/088
 416/244 R
 2008/0124224 A1* 5/2008 Tsai F04D 29/601
 416/244 R
 2008/0224013 A1* 9/2008 Huang F04D 29/646
 248/343
 2009/0096304 A1* 4/2009 Yang F04D 25/0613
 310/91
 2010/0132979 A1* 6/2010 Chen H02G 3/32
 174/135
 2015/0090858 A1* 4/2015 Broughman F04D 29/601
 248/674
 2016/0111816 A1* 4/2016 Walker H01R 13/26
 417/423.7
 2018/0252227 A1* 9/2018 Tang F04D 29/64
 2020/0141537 A1* 5/2020 Trout F16M 13/027
 2020/0217331 A1* 7/2020 Beaman F04D 29/601

* cited by examiner

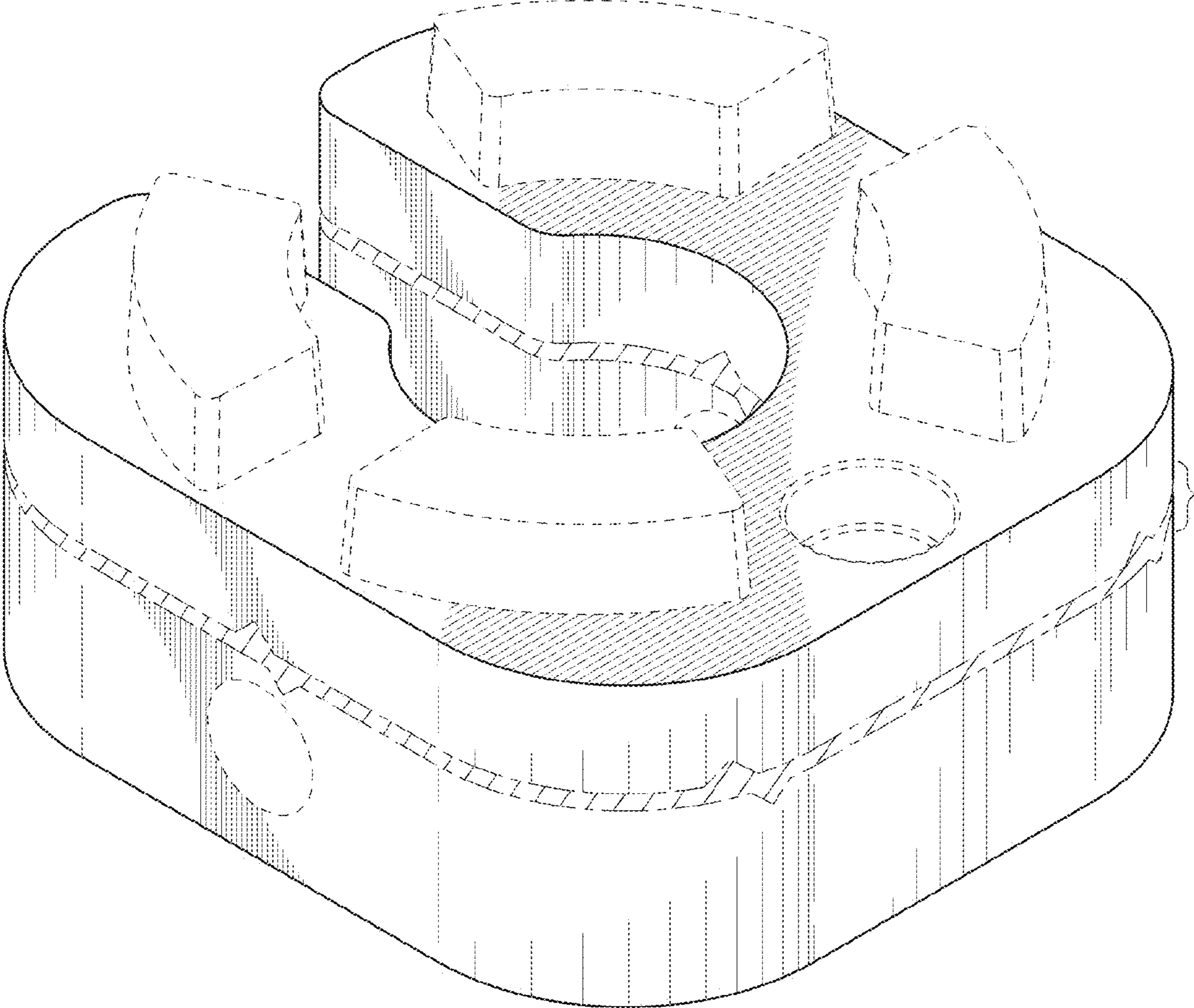

FIG. 1

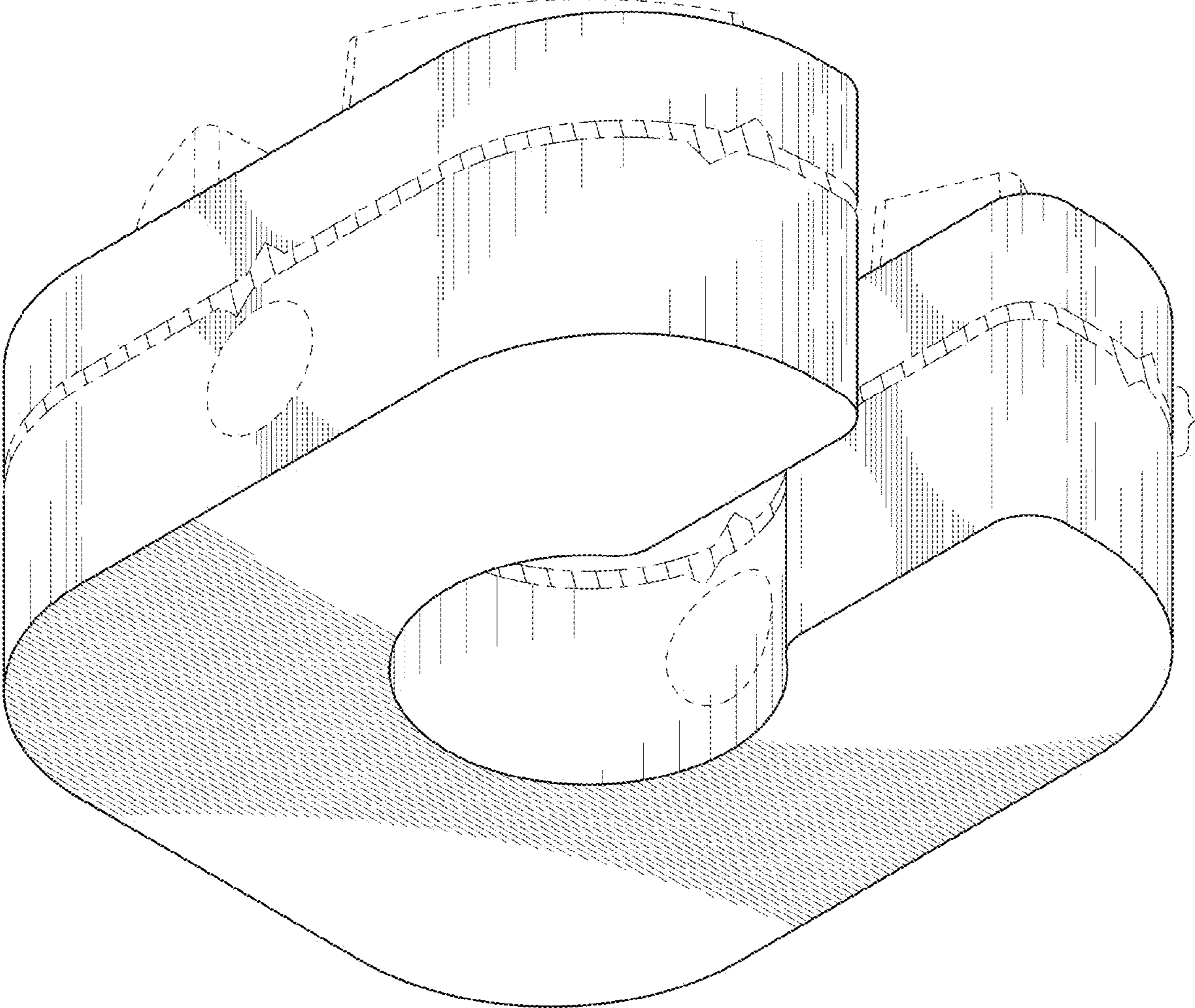

FIG. 2

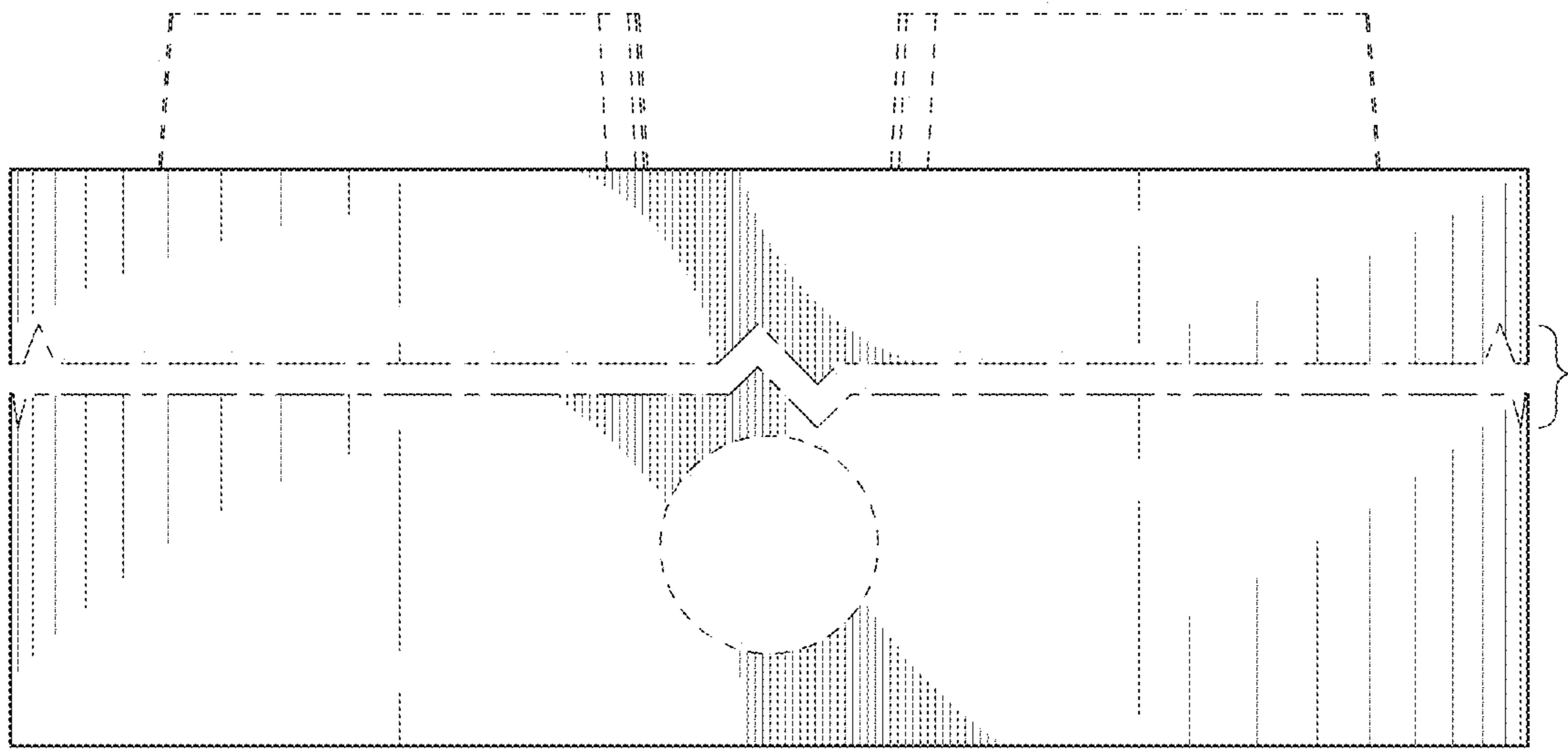

FIG. 3

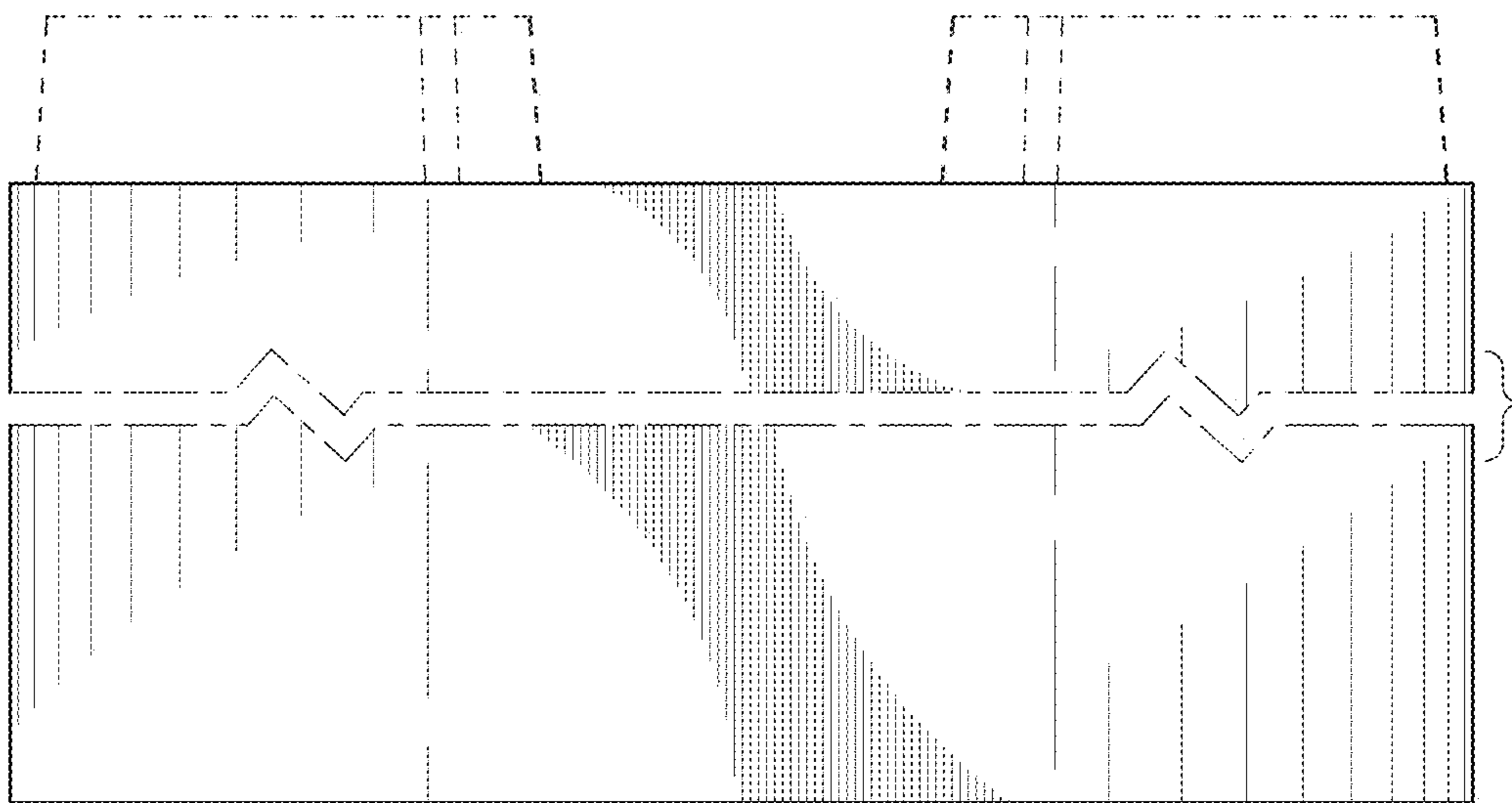

FIG. 4

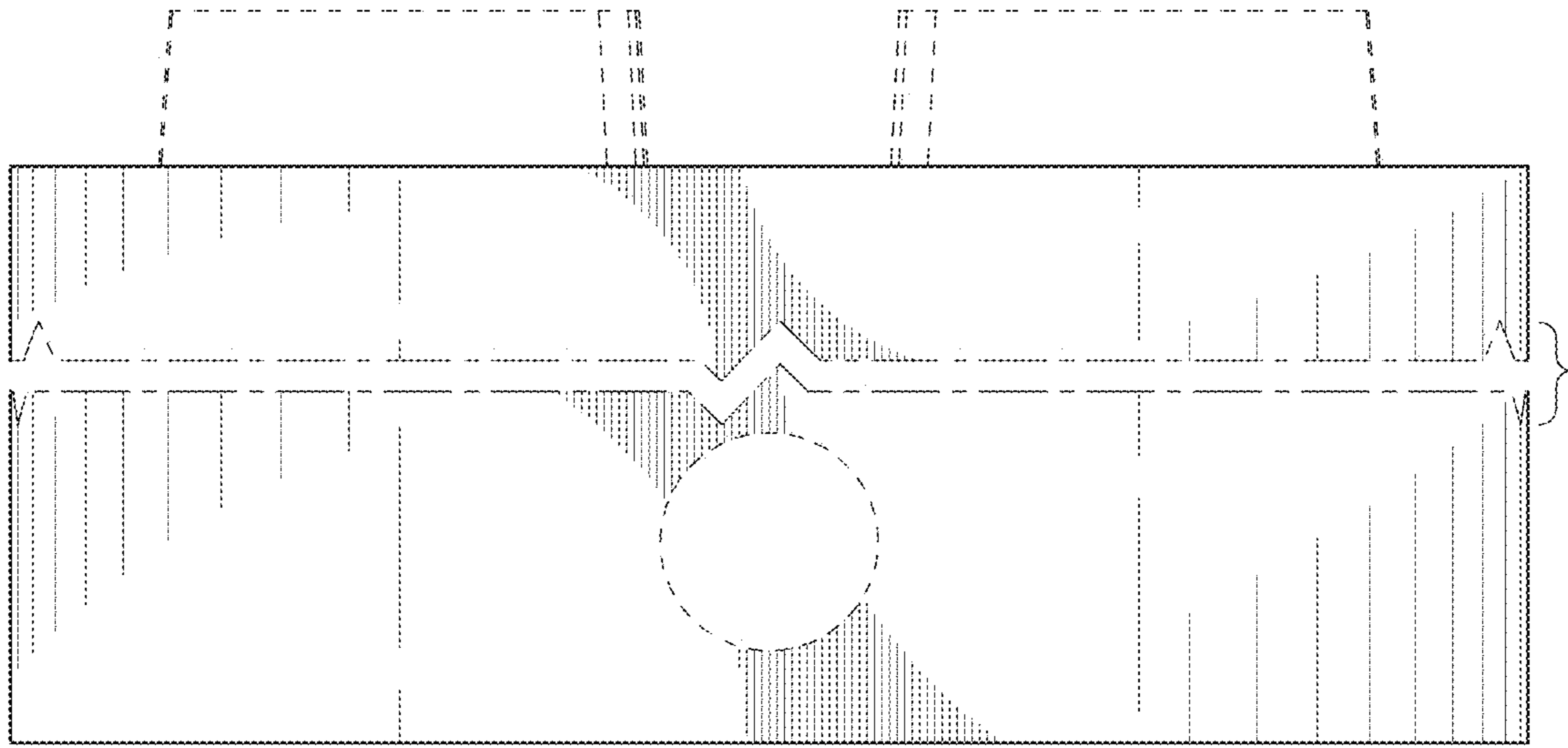

FIG. 5

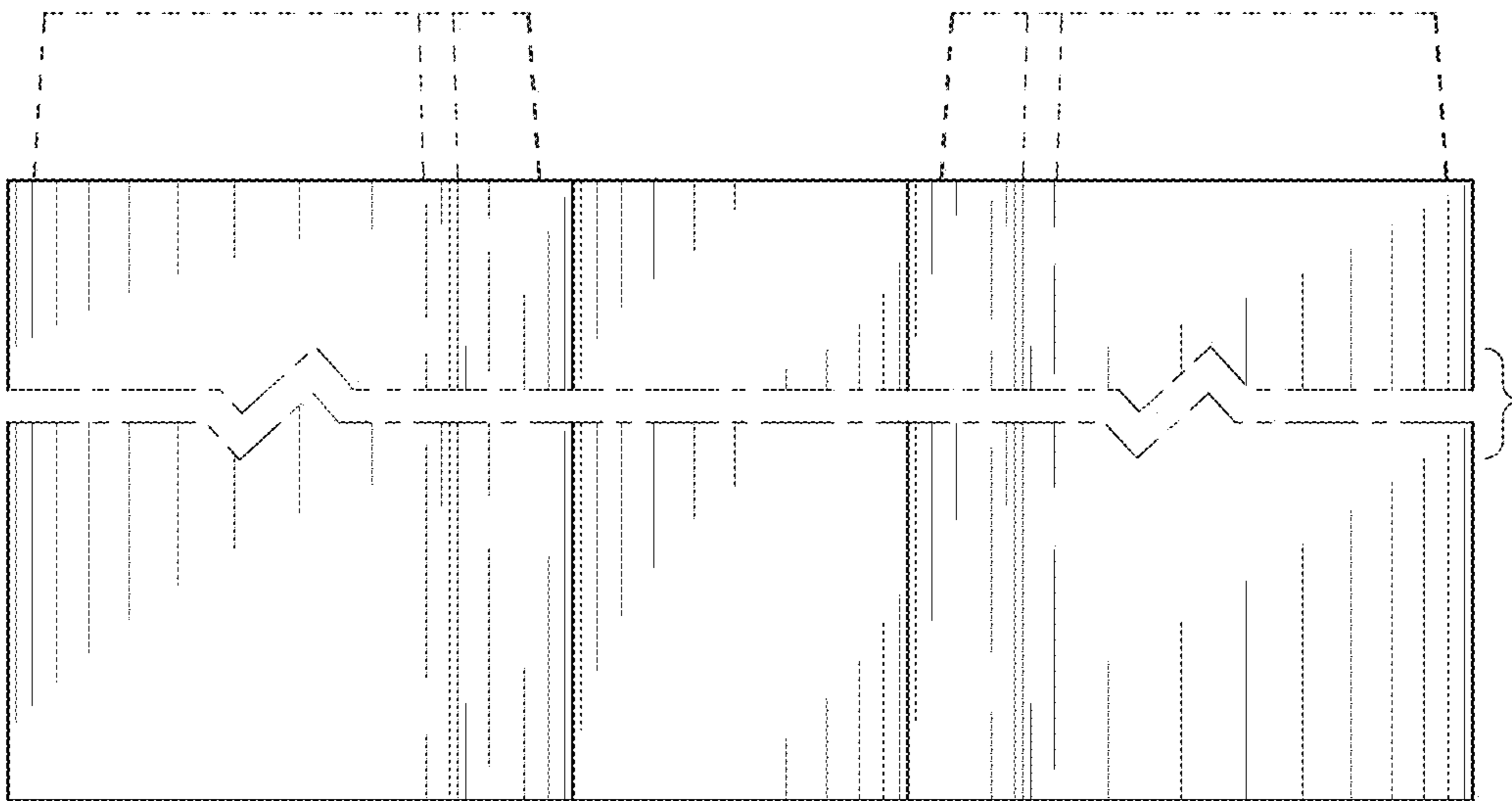

FIG. 6

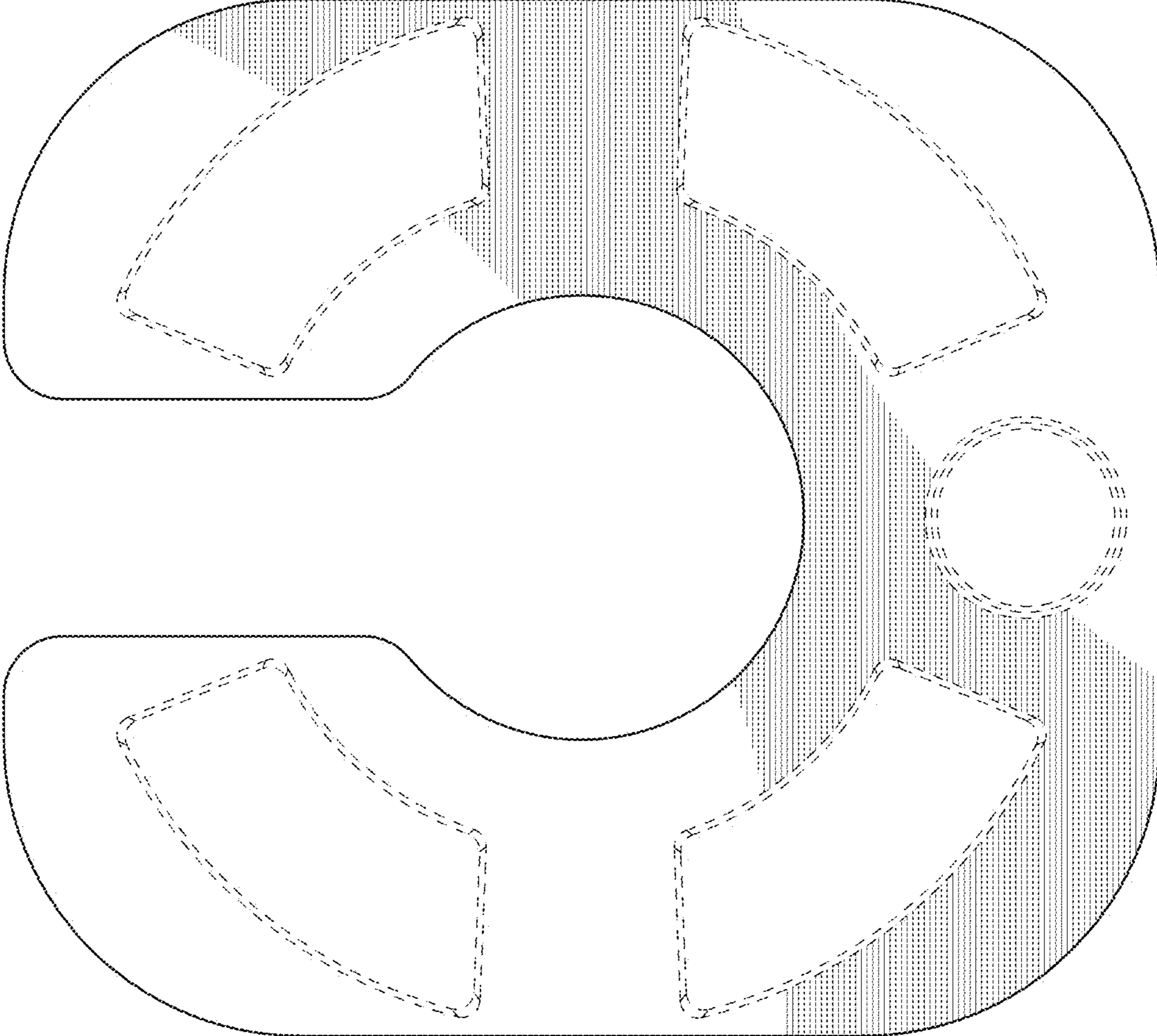

FIG. 7

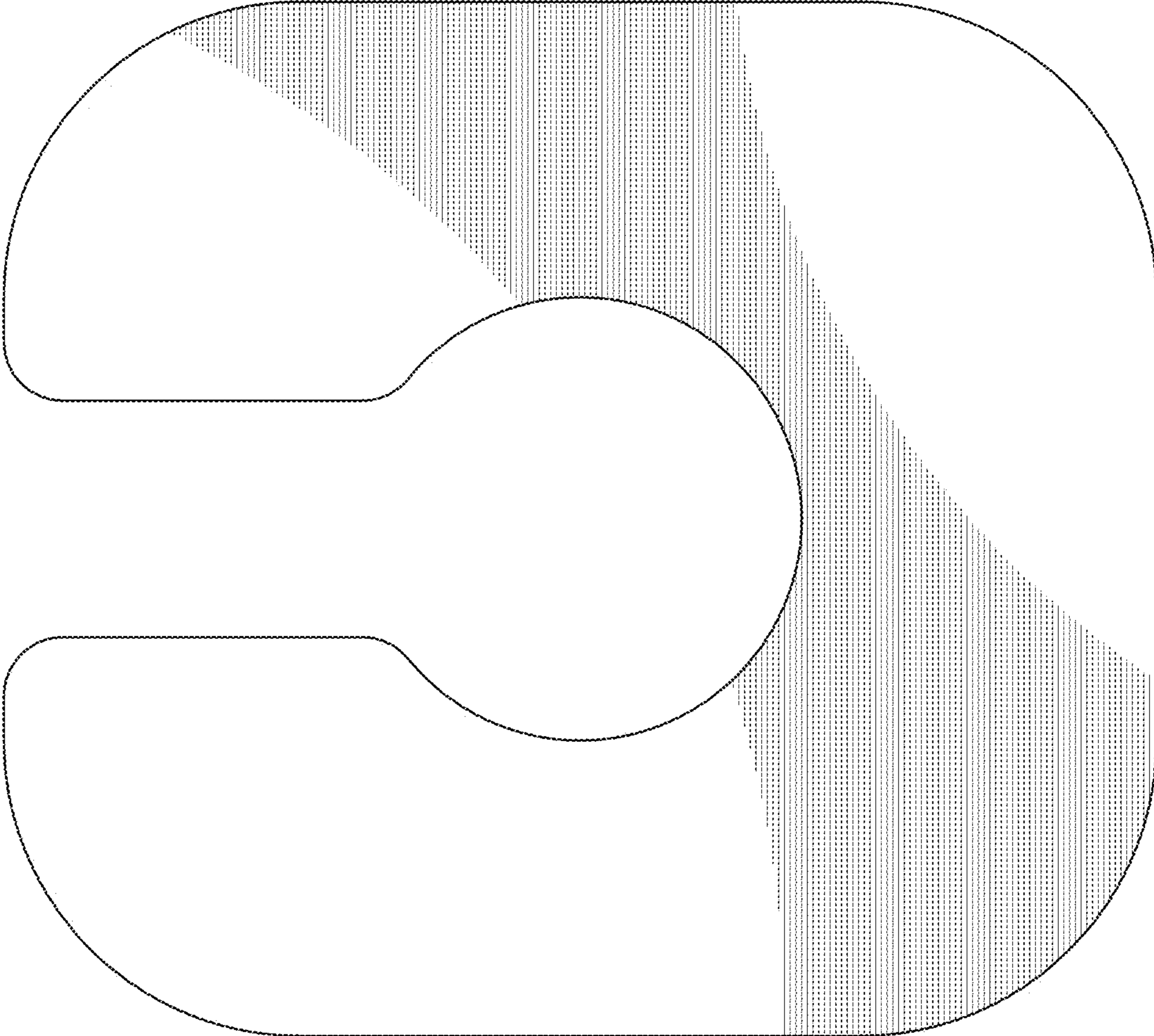

FIG. 8