



US00D910805S

(12) **United States Design Patent**
Barsten

(10) **Patent No.:** **US D910,805 S**

(45) **Date of Patent:** **** Feb. 16, 2021**

(54) **FISHING ROD HOLDER**

2013/0055621 A1* 3/2013 Fong A01K 97/10
43/21.2

(71) Applicant: **Selkirk Design, LLC**, Greenacres, WA (US)

* cited by examiner

(72) Inventor: **Jerrald Barsten**, Greenacres, WA (US)

Primary Examiner — Catherine R Oliver-Garcia
(74) *Attorney, Agent, or Firm* — Lee & Hayes, P.C.

(73) Assignee: **Selkirk Design, LLC**, Greenacres, WA (US)

(57) **CLAIM**

The ornamental design for a fishing rod holder, as shown and described.

(**) Term: **15 Years**

DESCRIPTION

(21) Appl. No.: **29/715,830**

FIG. 1 is a top perspective view of a fishing rod holder, showing the fishing rod holder in an unsecured state; FIG. 2 is a front view thereof; FIG. 3 is a rear view thereof; FIG. 4 is a left-side view thereof; FIG. 5 is a right-side view thereof; FIG. 6 is a top view thereof; FIG. 7 is a bottom view thereof; FIG. 8 is a top perspective view of a fishing rod holder, showing the fishing rod holder in a secured state; FIG. 9 is a front view thereof; FIG. 10 is a rear view thereof; FIG. 11 is a left-side view thereof; FIG. 12 is a right-side view thereof; FIG. 13 is a top view thereof; and, FIG. 14 is a bottom view thereof.

(22) Filed: **Dec. 4, 2019**

(51) **LOC (13) Cl.** **22-05**

(52) **U.S. Cl.**
USPC **D22/147**

(58) **Field of Classification Search**
USPC D22/147; D6/552–553, 567; 211/301, 211/70.8, 60.1; 248/512, 520, 538; 43/21.2, 23, 25
CPC A01K 87/00; A01K 87/08; A01K 97/10; A47B 81/005
See application file for complete search history.

The dashed broken lines depict portions of the fishing rod holder that form no part of the claimed design. The dot-dashed broken lines represent boundaries of the claimed fishing rod holder and form no part of the claimed design.

(56) **References Cited**

U.S. PATENT DOCUMENTS

- 4,017,998 A * 4/1977 Dumler A01K 97/10
43/21.2
- D749,872 S * 2/2016 Gonzalez D6/552
- D904,555 S * 12/2020 Hall D22/147

1 Claim, 14 Drawing Sheets

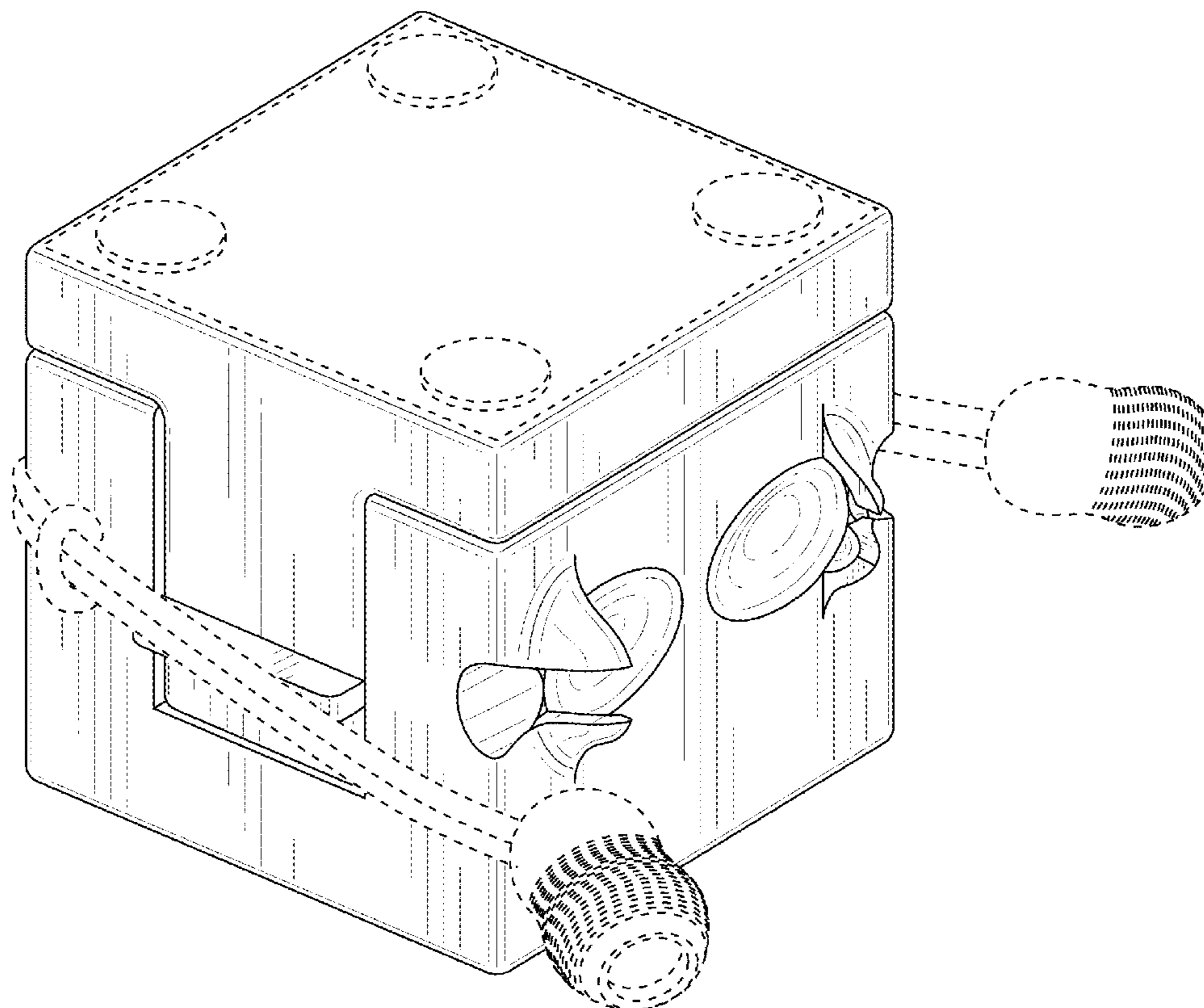

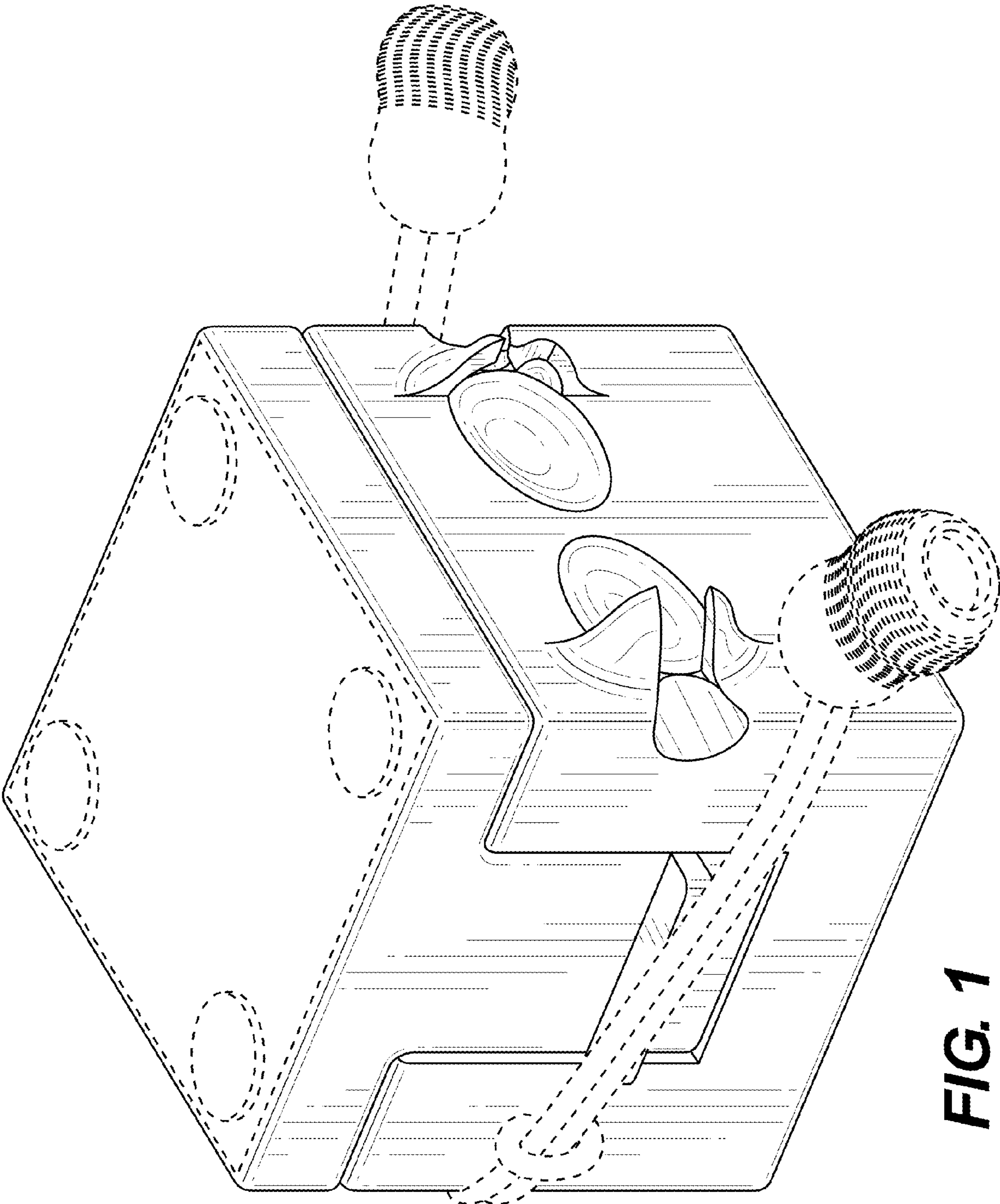

FIG. 1

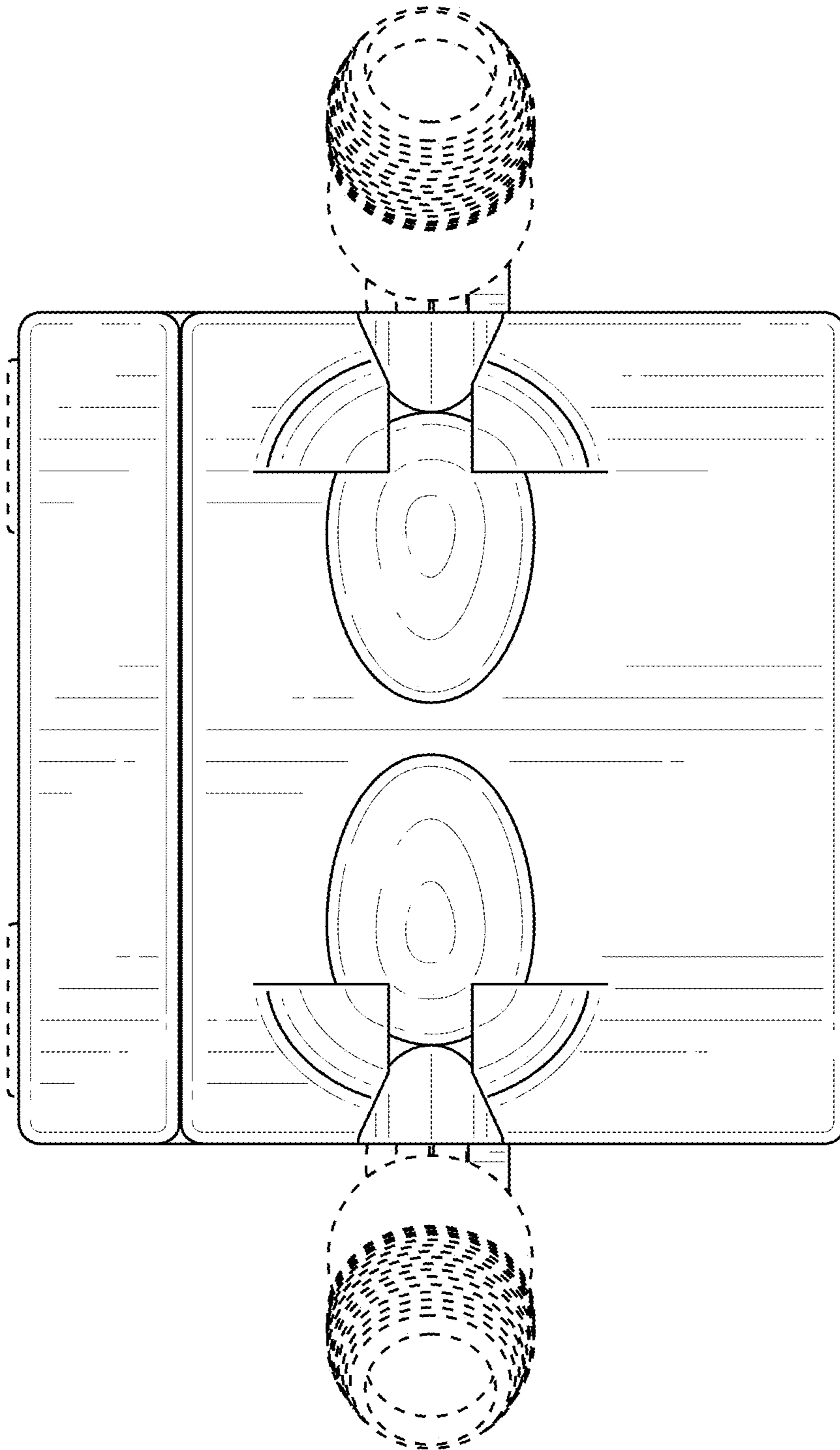

FIG. 2

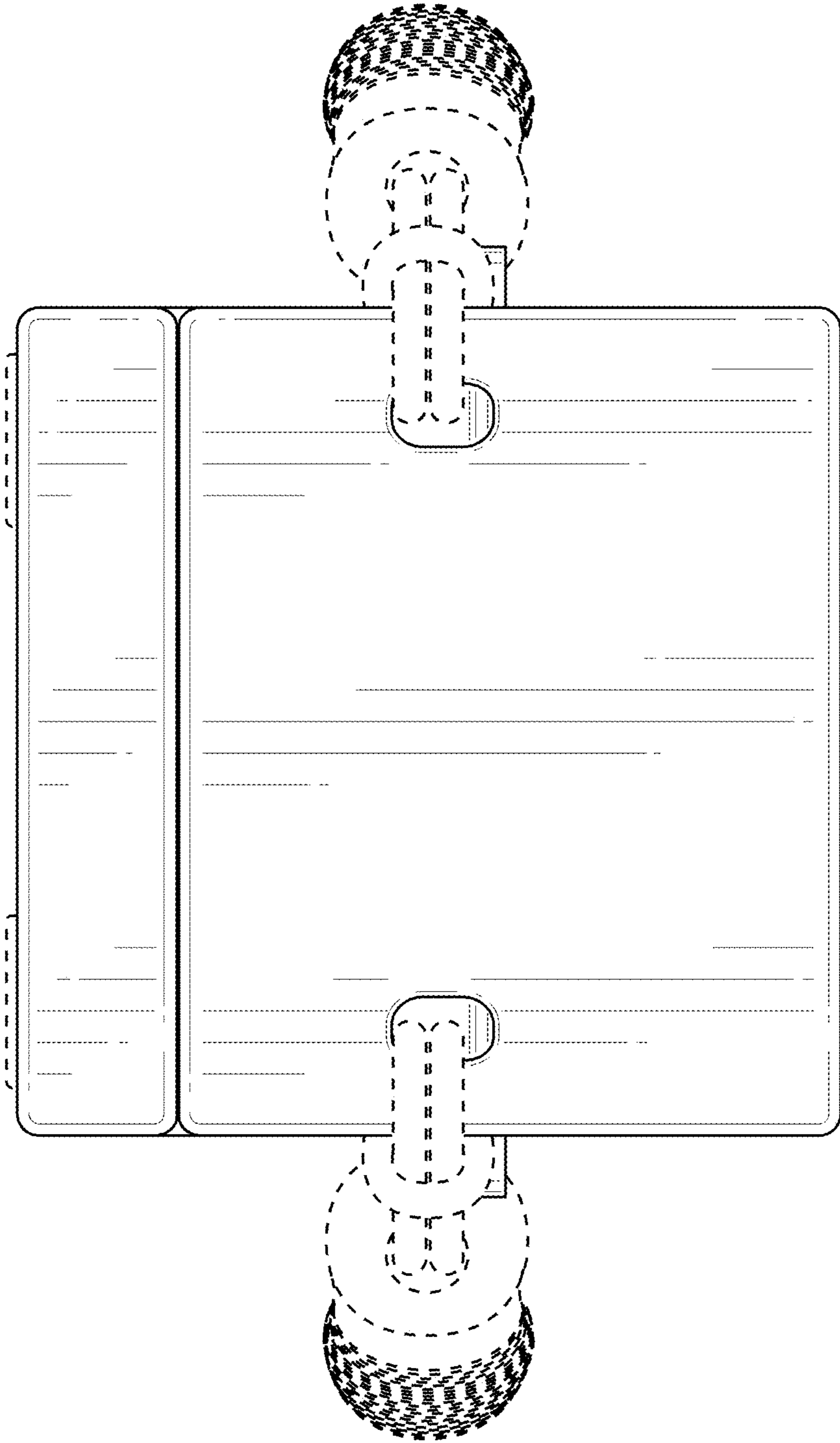

FIG. 3

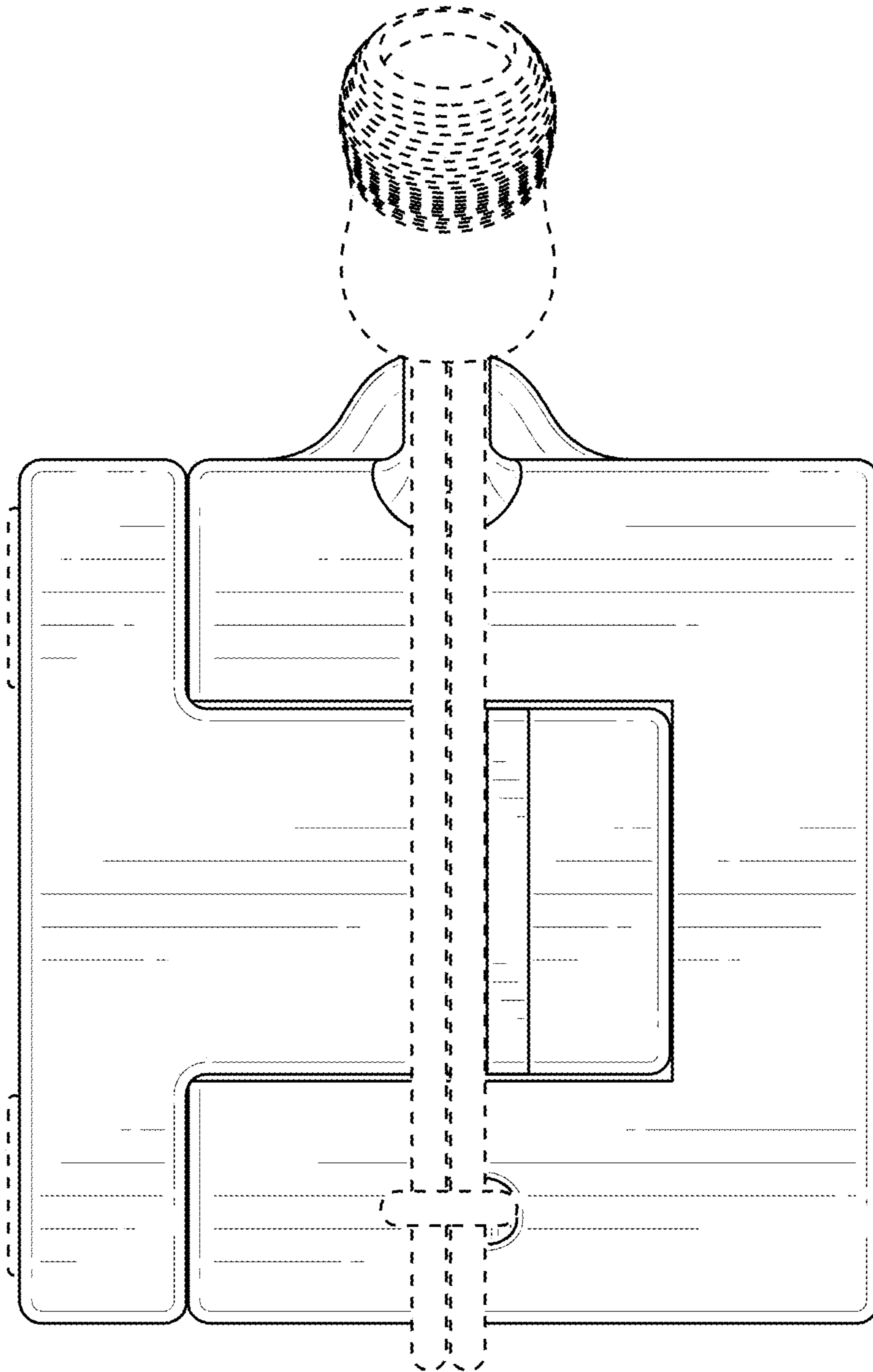

FIG. 4

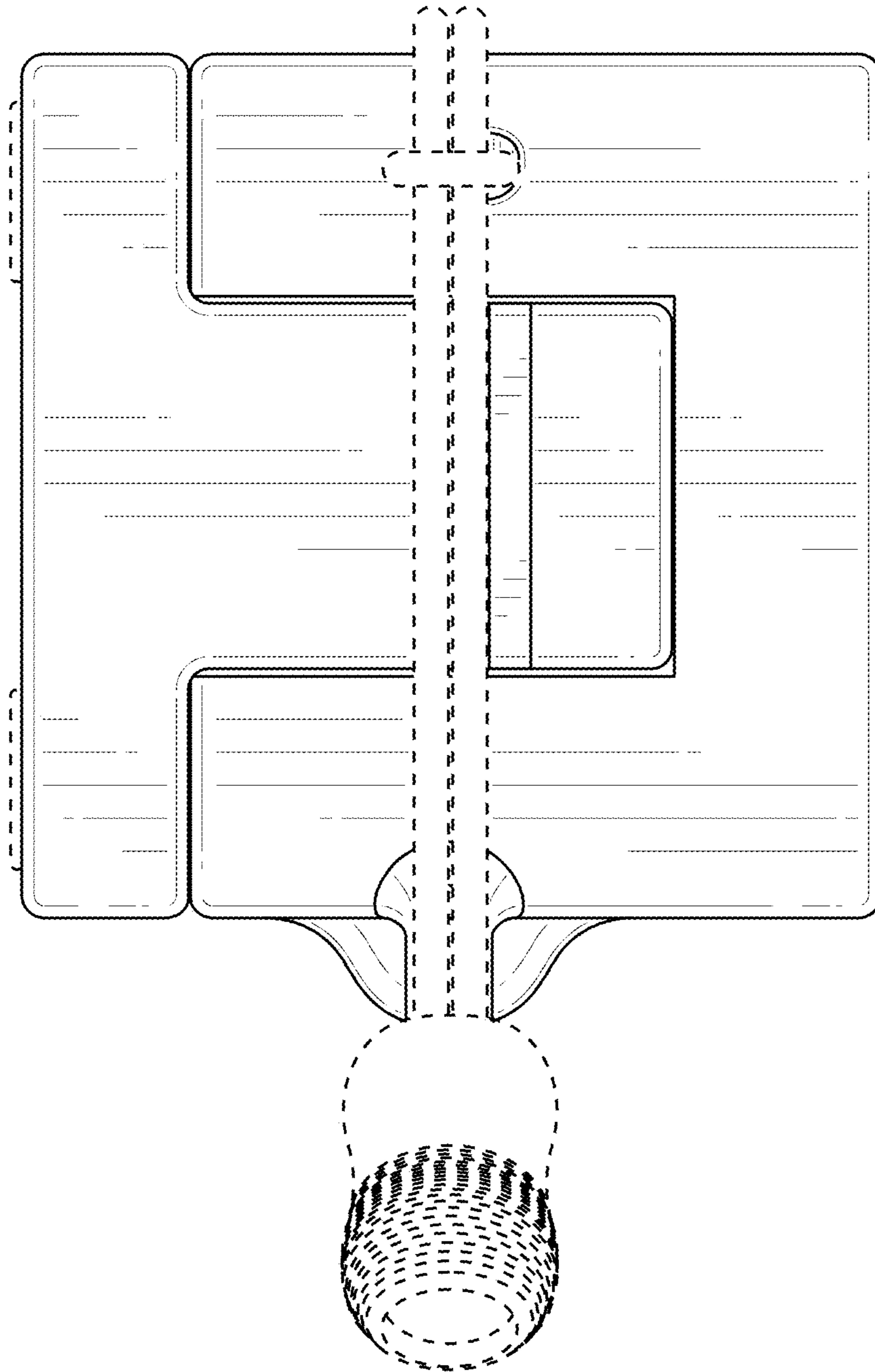

FIG. 5

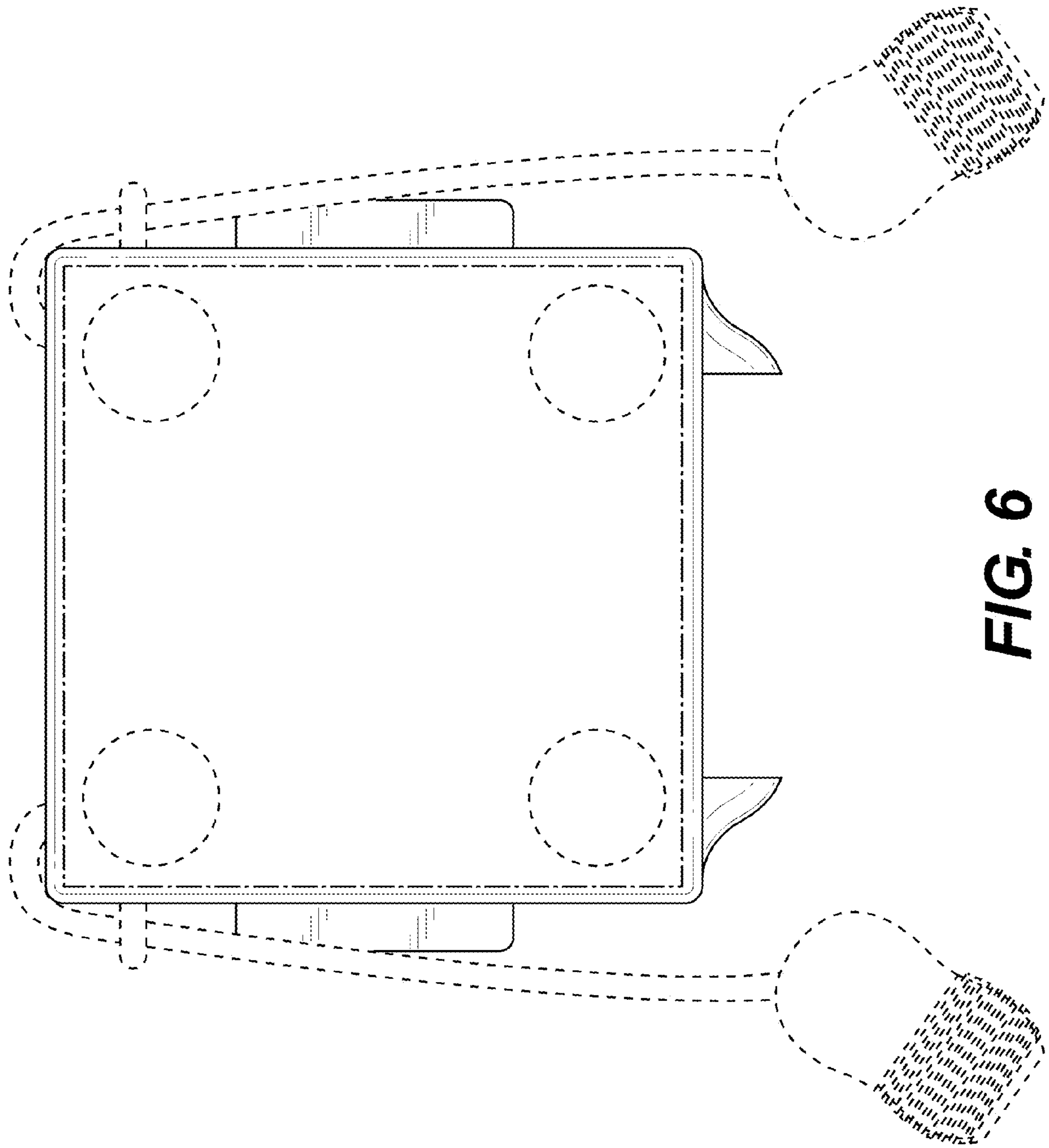

FIG. 6

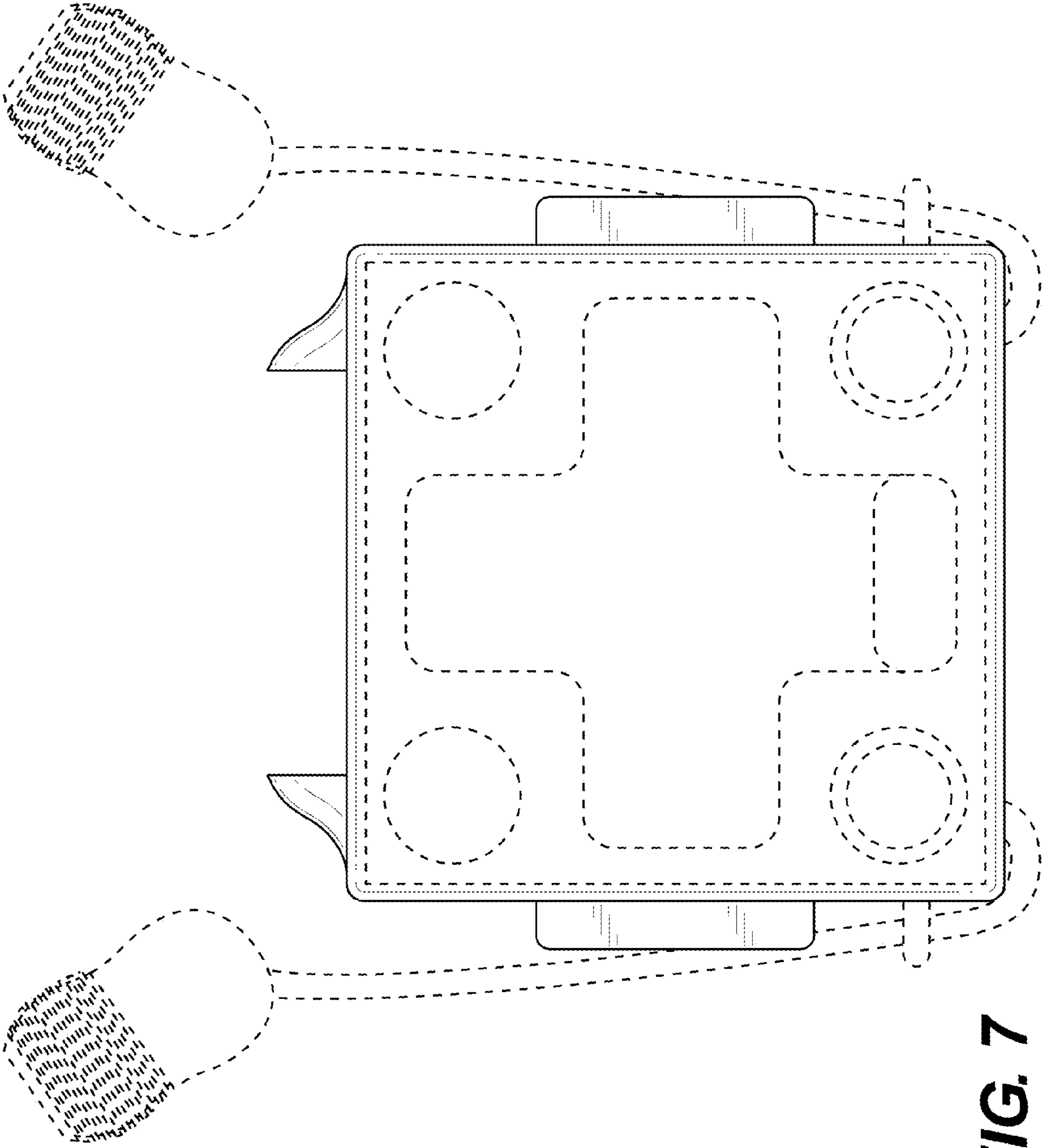

FIG. 7

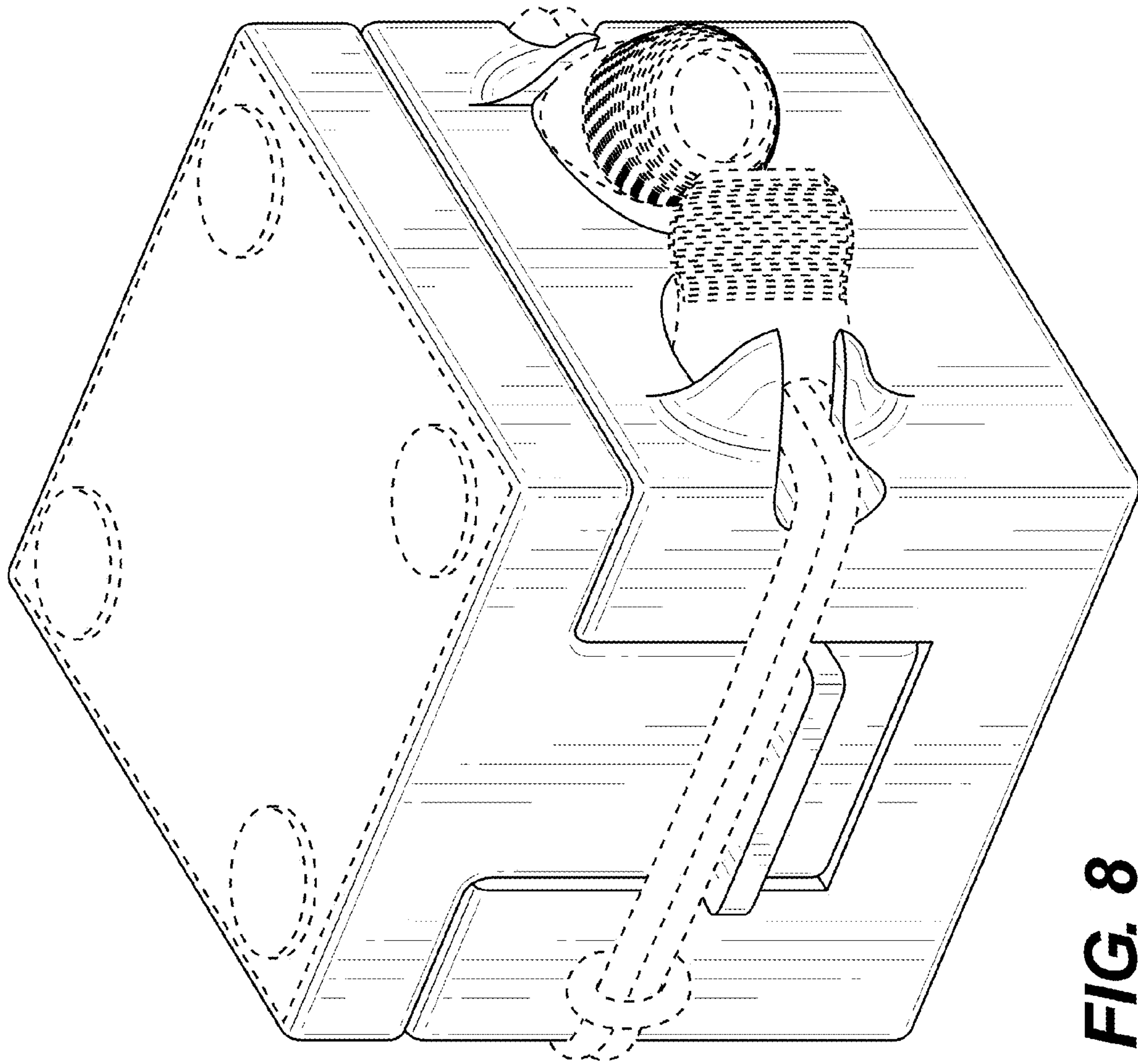

FIG. 8

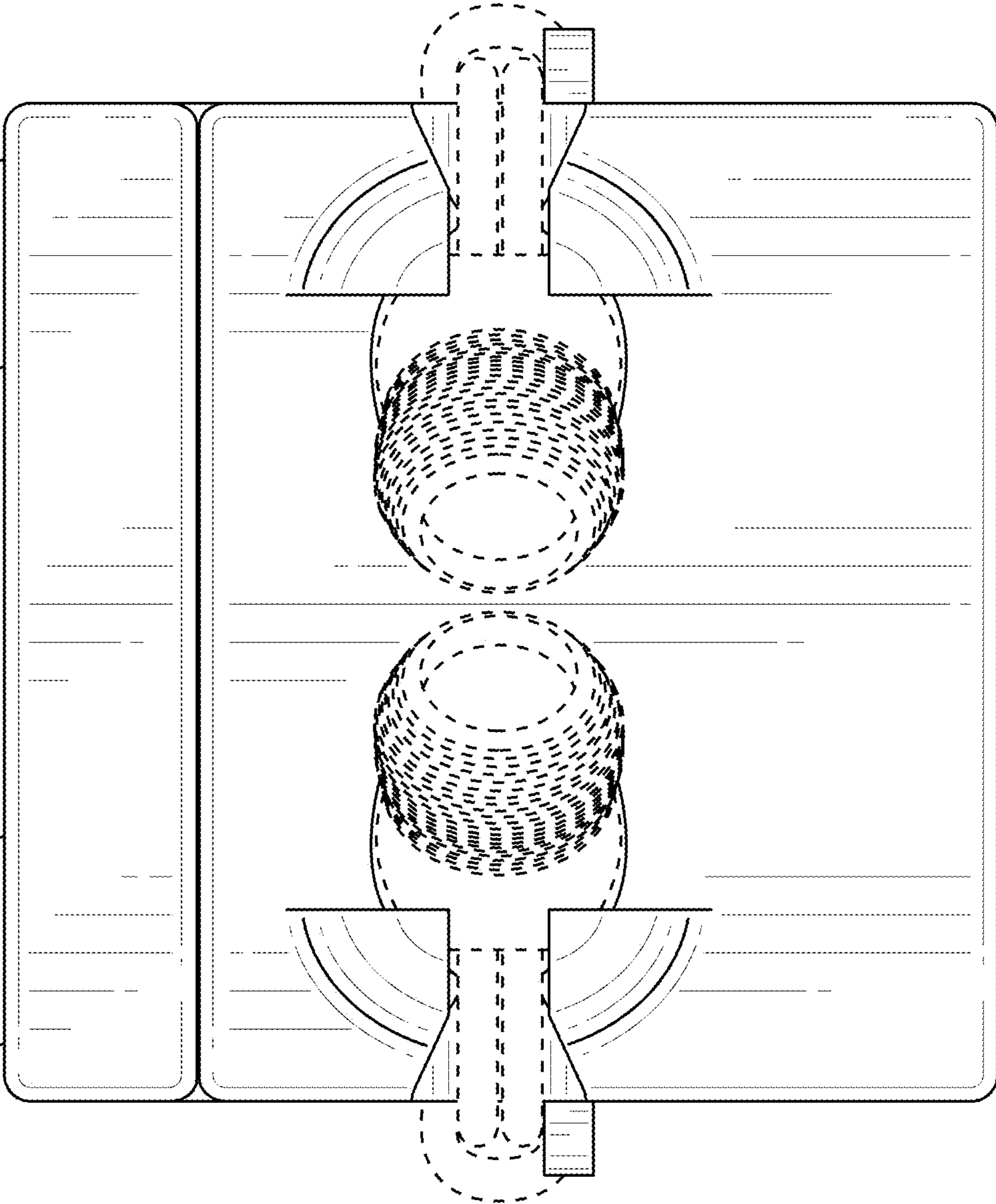

FIG. 9

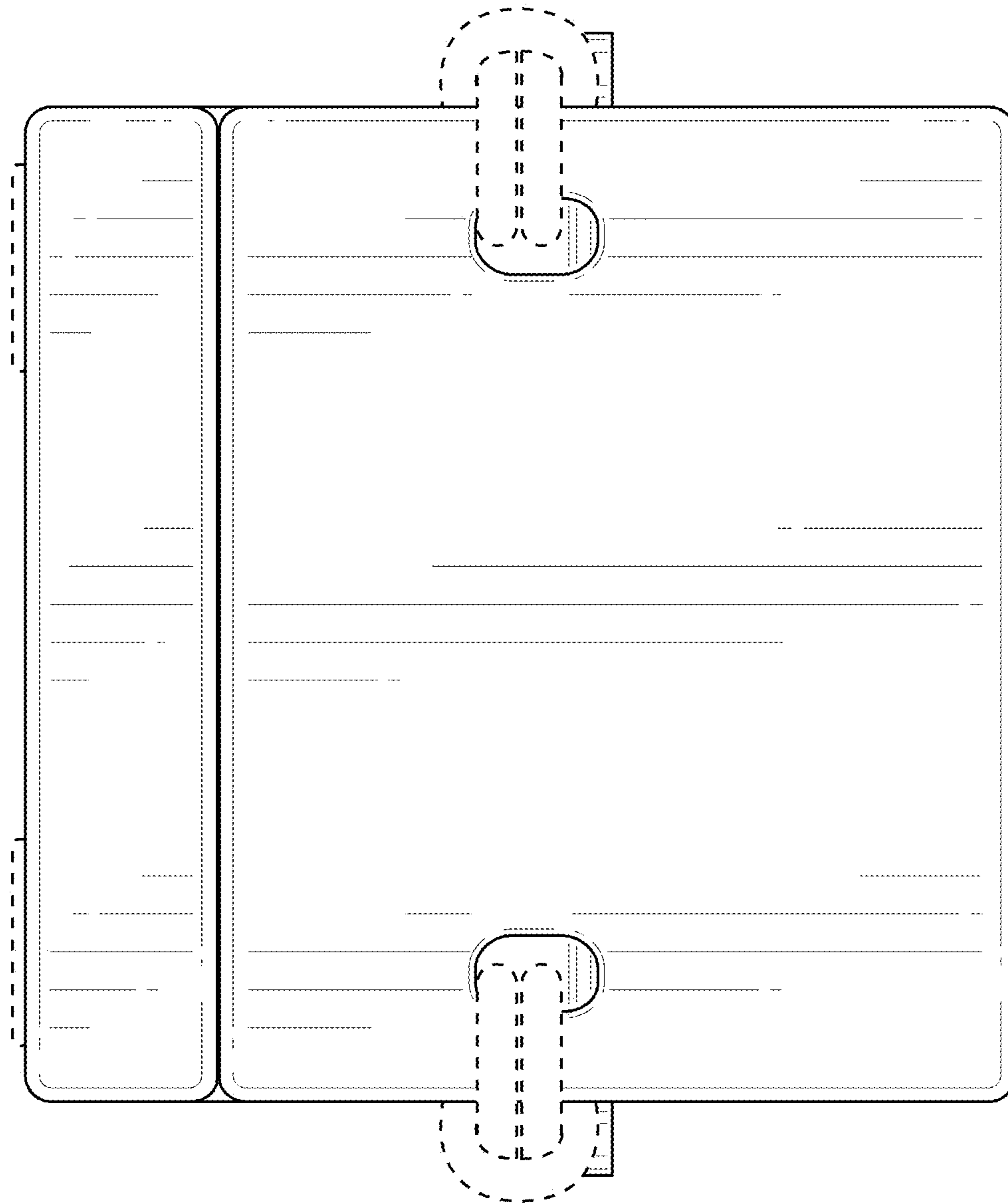

FIG. 10

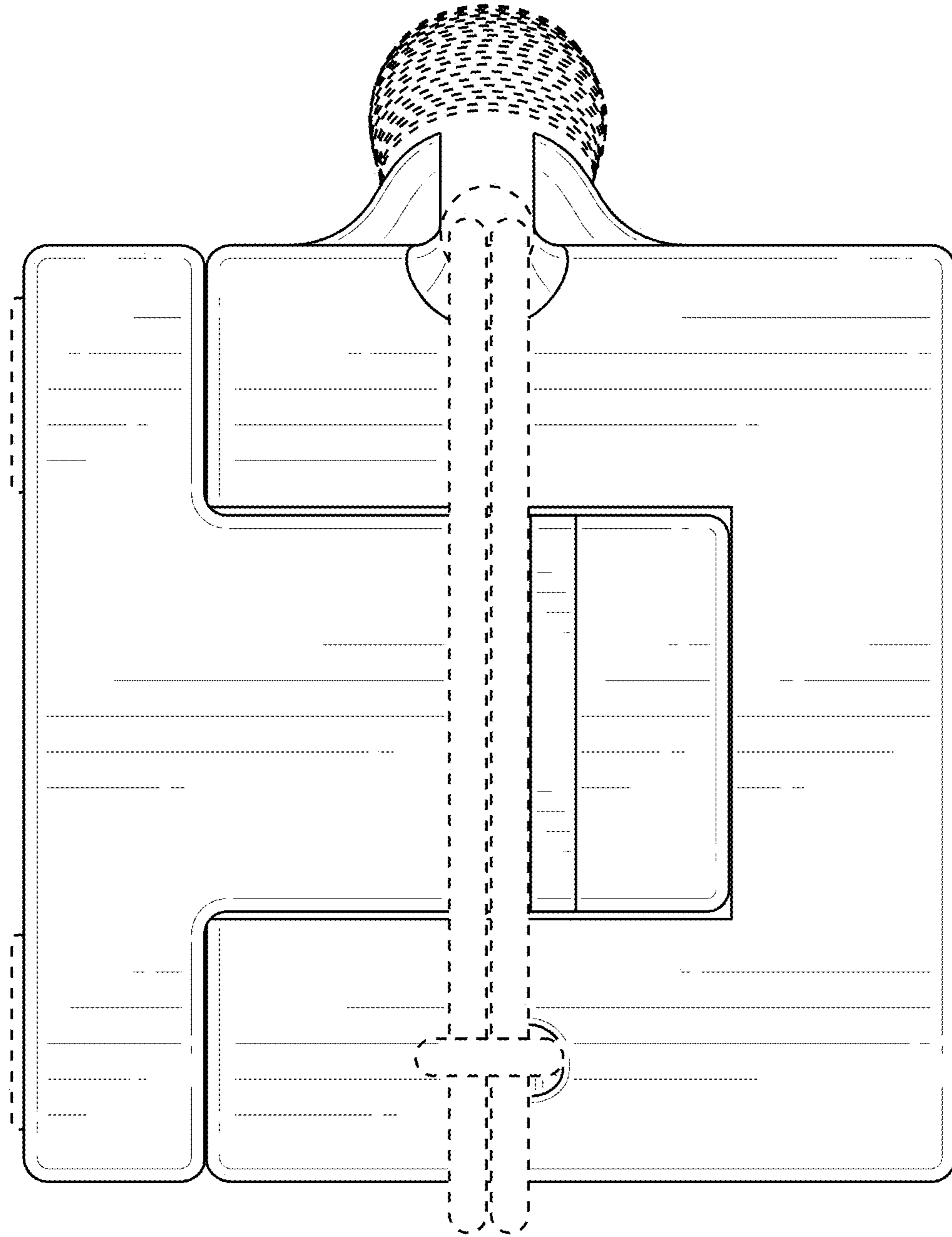

FIG. 11

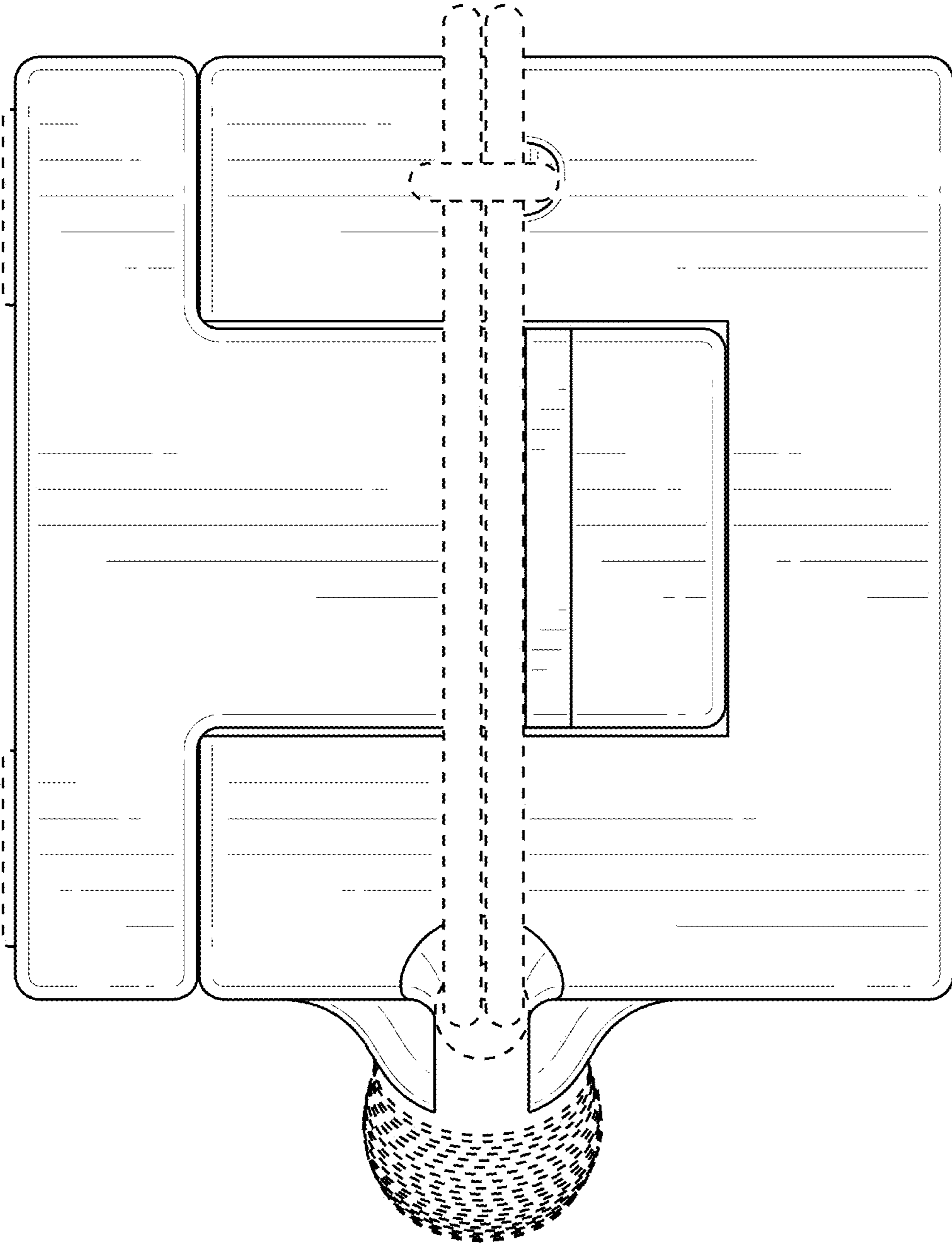

FIG. 12

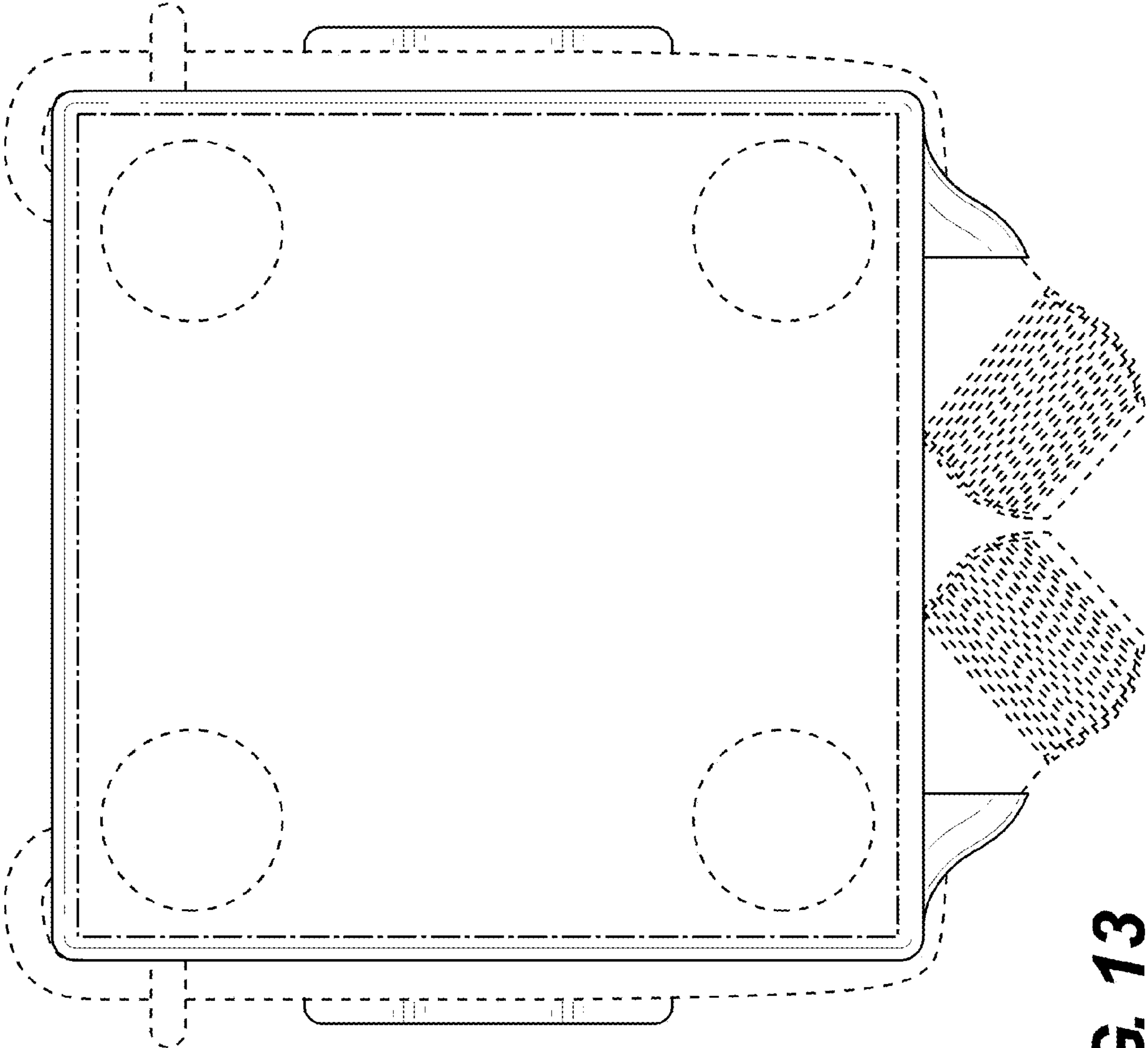

FIG. 13

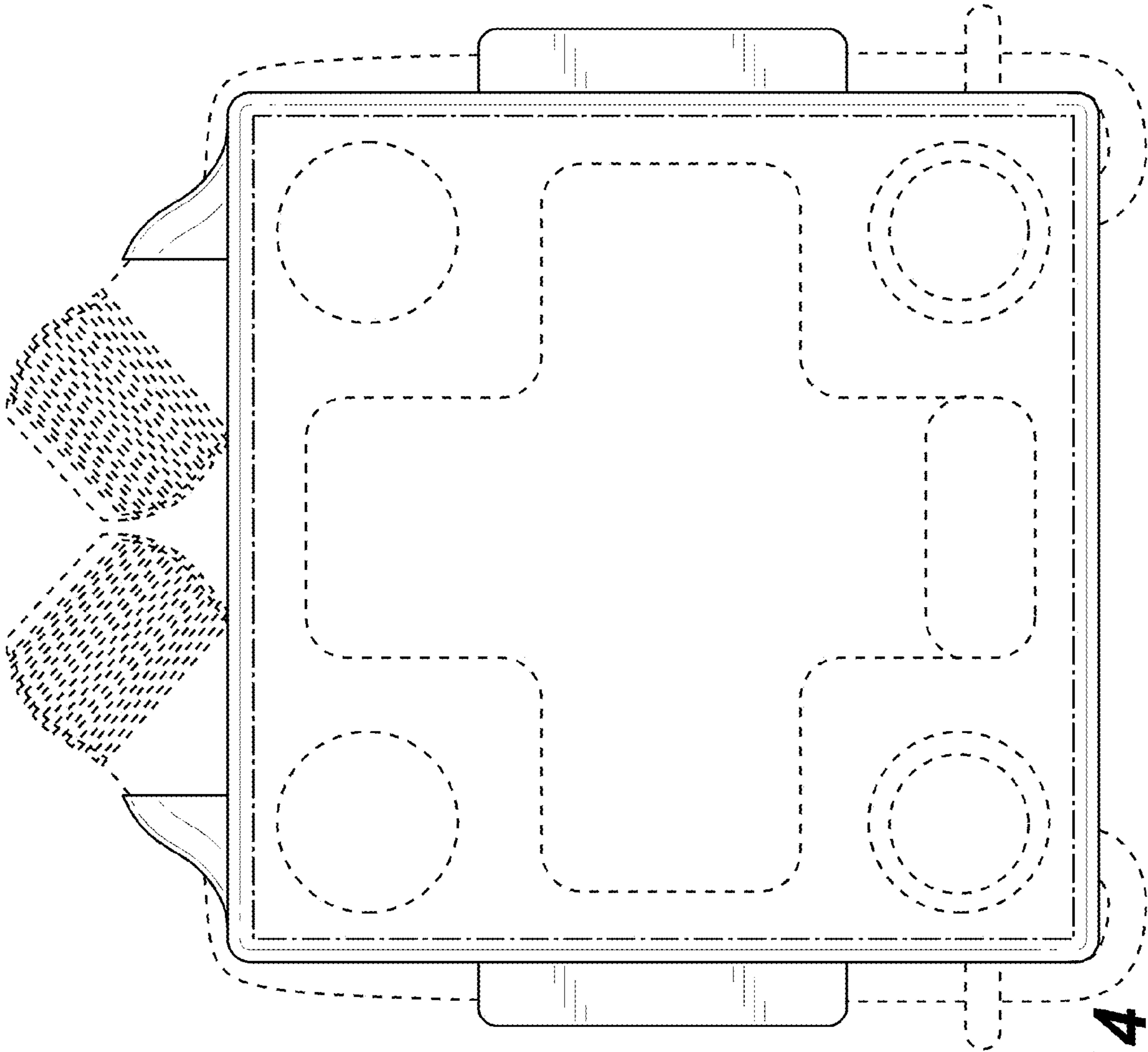

FIG. 14