



US00D910790S

(12) **United States Design Patent**  
**Schweigert et al.**

(10) **Patent No.:** **US D910,790 S**

(45) **Date of Patent:** **\*\* Feb. 16, 2021**

- (54) **GOLF CLUB HEAD**
- (71) Applicant: **PARSONS XTREME GOLF, LLC**,  
Scottsdale, AZ (US)
- (72) Inventors: **Bradley D. Schweigert**, Cave Creek,  
AZ (US); **Michael R. Nicolette**,  
Scottsdale, AZ (US)
- (73) Assignee: **PARSONS XTREME GOLF, LLC**,  
Scottsdale, AZ (US)
- (\*\*) Term: **15 Years**
- (21) Appl. No.: **29/698,135**
- (22) Filed: **Jul. 15, 2019**

5,390,919 A	2/1995	Stubbs
5,429,366 A	7/1995	McCabe
D363,101 S	10/1995	Sturm
5,489,097 A	2/1996	Simmons
D368,751 S	4/1996	Rife
D369,393 S	4/1996	Oku
D365,864 S	10/1996	Strum
5,571,053 A	11/1996	Lane
D378,688 S	4/1997	Cameron, Jr.
D380,514 S	7/1997	Markley
D385,609 S	10/1997	Cameron
5,683,307 A	11/1997	Rife
D388,143 S	12/1997	Huan-Chiang
D389,207 S	1/1998	Cameron
D398,685 S	9/1998	Masuda
D399,290 S	10/1998	Sizemore, Jr.
D399,911 S	10/1998	Sanchez
5,839,974 A	11/1998	McAllister
D405,836 S	2/1999	Nicolette et al.
D409,701 S	5/1999	Ashcraft et al.
5,924,938 A	7/1999	Hines
D422,655 S	4/2000	Hicks
D426,276 S	6/2000	Besnard et al.
D431,854 S	10/2000	Cameron
D432,192 S	10/2000	Hicks
D436,151 S	1/2001	Nicolette et al.
D437,374 S	2/2001	Cameron
D441,820 S	5/2001	Nicolette et al.
D443,668 S	6/2001	Nicolette et al.
D443,905 S	6/2001	Nicolette et al.
D444,833 S	7/2001	Nicolette
6,264,571 B1	7/2001	Lekavich
D449,664 S	10/2001	Beebe et al.
D449,865 S	10/2001	Fife, Jr. et al.
D450,799 S	11/2001	Nicolette et al.
D451,973 S	12/2001	Wells et al.
6,348,014 B1	2/2002	Chiu
6,354,959 B1	3/2002	Nicolette
6,394,910 B1	5/2002	McCarthy
D472,949 S	4/2003	Serrano
D474,821 S	5/2003	Wells et al.
D483,086 S	12/2003	Schweigert
D486,872 S	2/2004	Schweigert et al.
D496,276 S	11/2004	Schweigert et al.
6,902,496 B2	6/2005	Solheim
D511,801 S	11/2005	Garcia
D512,114 S	11/2005	Garcia
D512,116 S	11/2005	Miraflor et al.
6,988,956 B2	1/2006	Cover
D520,088 S	5/2006	Parr
D531,242 S	10/2006	Adams
D532,067 S	11/2006	Soracco
7,153,220 B2	12/2006	Lo

**Related U.S. Application Data**

- (63) Continuation-in-part of application No. 29/692,728,  
filed on May 28, 2019, now abandoned.
- (51) **LOC (13) Cl.** ..... **21-02**
- (52) **U.S. Cl.**  
USPC ..... **D21/736**
- (58) **Field of Classification Search**  
USPC ..... D21/736-746, 759  
CPC ..... A63B 53/00; A63B 53/04; A63B 53/007;  
A63B 53/065; A63B 53/0487; A63B  
60/00; A63B 60/46  
See application file for complete search history.

(56) **References Cited**

**U.S. PATENT DOCUMENTS**

RE19,178 E	5/1934	Spiker
4,043,562 A	8/1977	Shillington
D248,783 S	8/1978	Long
D281,092 S	10/1985	Mills
4,754,977 A	7/1988	Sahm
4,869,507 A	9/1989	Sahm
D313,451 S	1/1991	Shearer
D335,317 S	5/1993	Shearer
D335,692 S	5/1993	Antonious
D336,757 S	6/1993	Antonious
D350,582 S	9/1994	Miansian et al.

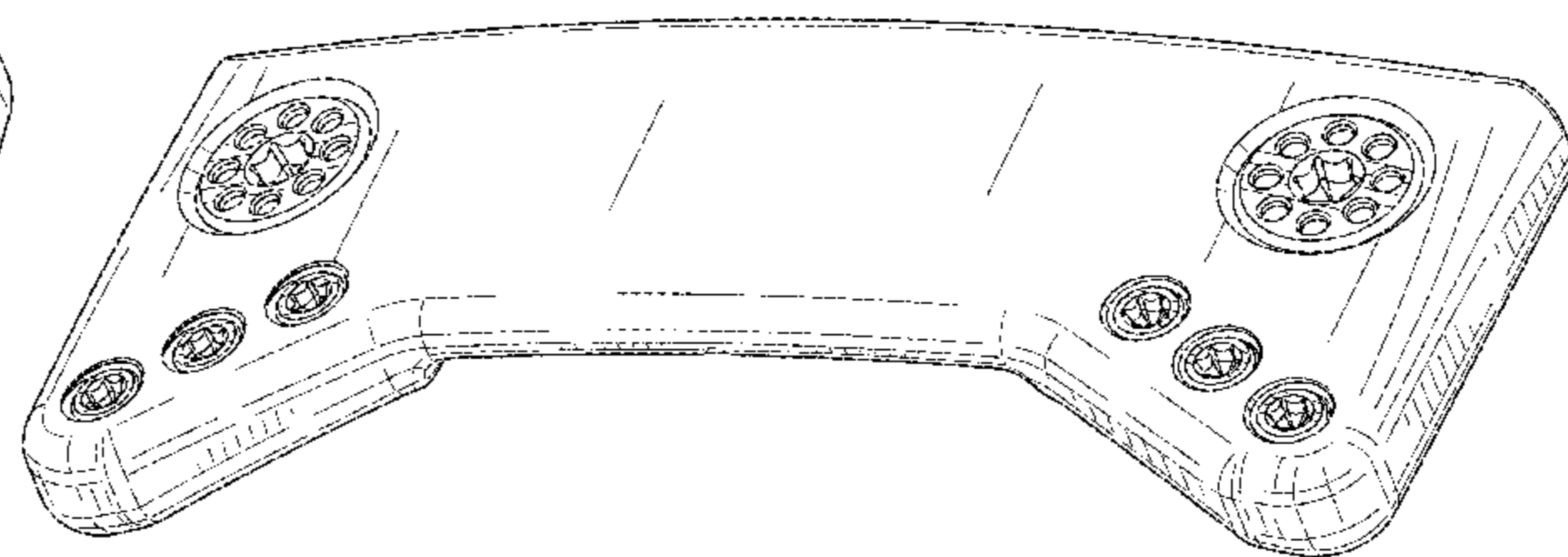
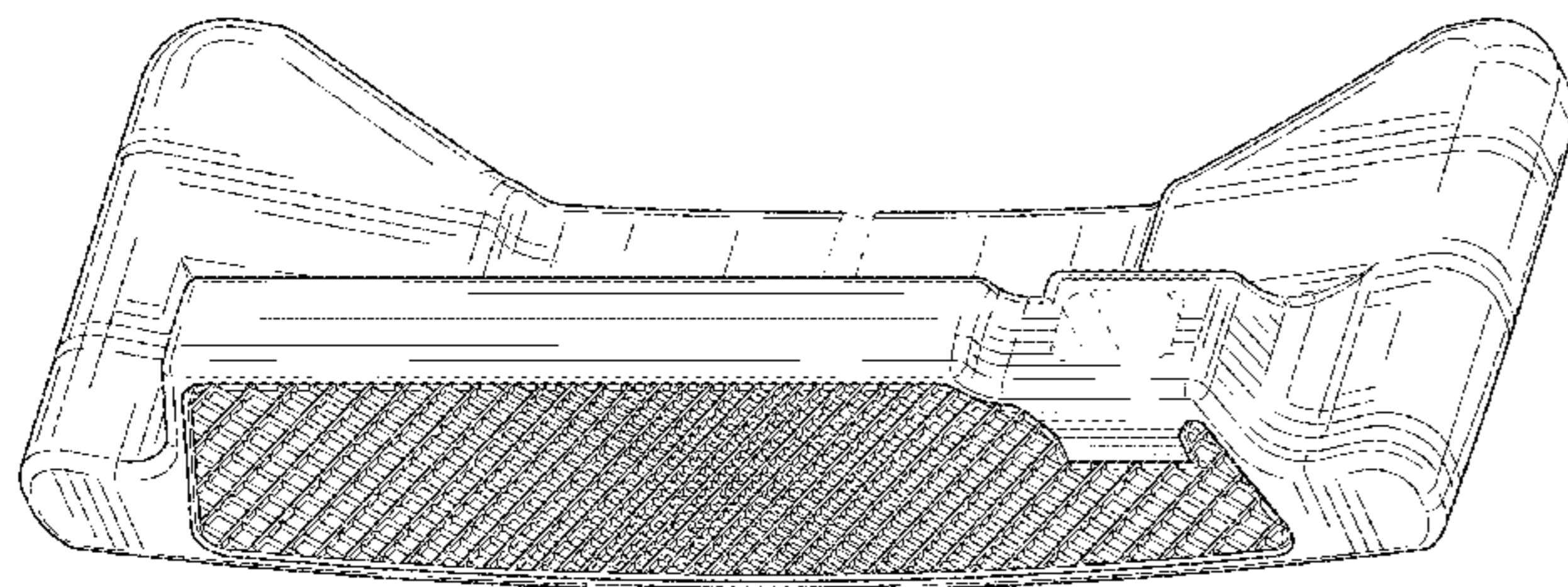



D534,595 S 1/2007 Hasebe  
 7,156,752 B1 1/2007 Bennett  
 D536,401 S 2/2007 Kawami  
 D536,403 S 2/2007 Kawami  
 D538,371 S 3/2007 Kawami  
 7,204,765 B2 4/2007 Cover  
 D542,869 S 5/2007 Adams  
 D543,596 S 5/2007 Rockwood  
 D543,601 S 5/2007 Kawami  
 D555,219 S 11/2007 Lin  
 D556,277 S 11/2007 Broom  
 D561,854 S 2/2008 Morris  
 7,331,876 B2 2/2008 Klein  
 7,351,162 B2 4/2008 Soracco  
 D569,461 S 5/2008 Morris  
 D569,930 S 5/2008 Nehrbas  
 7,396,289 B2 7/2008 Soracco  
 D577,086 S 8/2008 Nicolette et al.  
 D577,085 S 9/2008 Nicolette et al.  
 D579,506 S 10/2008 Nicolette et al.  
 D579,995 S 11/2008 Nicolette et al.  
 D582,497 S 12/2008 Rollinson  
 7,473,189 B2 1/2009 Schweigert  
 7,491,131 B2 2/2009 Vinton  
 D599,425 S 9/2009 Laub  
 D599,867 S 9/2009 Teramoto  
 D600,763 S 9/2009 Cameron  
 D601,214 S 9/2009 Serrano  
 D607,951 S 1/2010 Teramoto  
 7,744,485 B2 6/2010 Jones  
 D620,993 S 8/2010 Laub  
 D623,709 S \* 9/2010 Serrano ..... D21/736  
 D631,925 S 2/2011 Broom  
 7,887,432 B2 2/2011 Jones  
 D633,964 S 3/2011 Teramoto  
 7,909,707 B2 3/2011 Klein  
 7,918,745 B2 4/2011 Morris  
 7,927,226 B1 4/2011 Twitty  
 D638,891 S 5/2011 Nicolette et al.  
 D642,643 S 8/2011 Nicolette et al.  
 D643,485 S 8/2011 Nicolette et al.  
 D645,104 S 9/2011 Nicolette et al.  
 D650,455 S \* 12/2011 Serrano ..... D21/743  
 8,096,039 B2 1/2012 Soracco  
 D653,718 S 2/2012 Stokke et al.  
 D655,361 S 3/2012 Ramsauer  
 D661,753 S 6/2012 Cameron et al.  
 D666,260 S 8/2012 Cynn  
 8,376,878 B2 2/2013 Bennett  
 D682,376 S \* 5/2013 Oliveiro ..... D21/736  
 D688,339 S 8/2013 Hilton et al.  
 D688,341 S 8/2013 Rollinson  
 D691,226 S 10/2013 Hilton et al.  
 D699,308 S 2/2014 Rollinson  
 D704,782 S 5/2014 Rollinson  
 8,721,472 B2 5/2014 Kuan  
 8,790,193 B2 7/2014 Serrano  
 D711,483 S 8/2014 Wong  
 D722,350 S 2/2015 Schweigert  
 D722,351 S 2/2015 Parsons et al.  
 D722,352 S 2/2015 Nicolette et al.  
 D723,120 S 2/2015 Nicolette  
 D724,164 S 3/2015 Schweigert et al.  
 D725,208 S \* 3/2015 Schweigert ..... D21/743  
 D726,265 S 4/2015 Nicolette  
 D726,846 S \* 4/2015 Schweigert ..... D21/743  
 D726,849 S 4/2015 Burns  
 D733,234 S 6/2015 Nicolette  
 D735,283 S \* 7/2015 Solheim ..... D21/743  
 D738,447 S \* 9/2015 Schweigert ..... D21/736  
 D738,449 S \* 9/2015 Schweigert ..... D21/759  
 D739,487 S 9/2015 Schweigert  
 D741,426 S \* 10/2015 Schweigert ..... D21/736  
 D746,926 S 1/2016 Parsons  
 D748,213 S 1/2016 Parsons et al.  
 D748,215 S 1/2016 Parsons et al.  
 9,233,283 B2 \* 1/2016 Schweigert ..... A63B 60/02  
 D752,697 S 3/2016 Claveran  
 D753,252 S \* 4/2016 Schweigert ..... D21/759

D791,891 S 7/2017 Davis  
 D794,146 S 8/2017 Davis  
 D812,163 S \* 3/2018 Kroloff ..... D21/736  
 10,493,331 B2 \* 12/2019 Kroloff ..... A63B 53/0433  
 D872,816 S \* 1/2020 Parsons ..... D21/736  
 10,737,153 B2 \* 8/2020 Schweigert ..... A63B 53/0487  
 2007/0142122 A1 6/2007 Bonneau  
 2007/0207875 A1 9/2007 Kuan  
 2007/0238548 A1 10/2007 Johnson  
 2008/0139333 A1 6/2008 Klein  
 2008/0146372 A1 6/2008 John  
 2008/0176672 A1 7/2008 Roach  
 2011/0165959 A1 7/2011 Klein  
 2013/0165256 A1 6/2013 Stevenson  
 2013/0210537 A1 8/2013 Ainscough  
 2018/0001163 A1 \* 1/2018 Becktor ..... A63B 53/0487  
 2018/0311545 A1 \* 11/2018 Lambeth ..... B23P 15/00

FOREIGN PATENT DOCUMENTS

JP 20050160691 6/2005

OTHER PUBLICATIONS

U.S. Appl. No. 14/586,720, Parsons et al., "Golf Club Heads and Methods to Manufacture Golf Club Heads," filed Dec. 30, 2014.  
 U.S. Appl. No. 29/523,587, Schweigert, "Golf Club Head," filed Apr. 10, 2015.  
 TourSpecGolf (Gold's Factory Multi Weighted Custom Putter) [online]. Nov. 20, 2010 [retrieved Jul. 7, 2015]. Retrieved from the internet: <URL: <http://www.tourspecgolf.com/blog/golds-factory-multi-weighted-custom-putter/>>.  
 International Search Report and Written Opinion Issued in Connection With Corresponding Application No. PCT/US15/27841 dated Jul. 30, 2015 (14 Pages).

\* cited by examiner

Primary Examiner — Mitchell I. Siegel

(57) CLAIM

The ornamental design for a golf club head, as shown and described.

DESCRIPTION

FIG. 1 is a top perspective view of a golf club head;  
 FIG. 2 is a bottom perspective view of the golf club head of FIG. 1;  
 FIG. 3 is a front elevational view of the golf club head of FIG. 1;  
 FIG. 4 is a rear elevational view of the golf club head of FIG. 1;  
 FIG. 5 is a top view of the golf club head of FIG. 1;  
 FIG. 6 is a bottom view of the golf club head of FIG. 1;  
 FIG. 7 is a left side view of the golf club head of FIG. 1;  
 FIG. 8 is a right side view of the golf club head of FIG. 1;  
 FIG. 9 is a top perspective view of a second embodiment of the golf club head;  
 FIG. 10 is a bottom perspective view of the golf club head of FIG. 9;  
 FIG. 11 is a front elevational view of the golf club head of FIG. 9;  
 FIG. 12 is a rear elevational view of the golf club head of FIG. 9;  
 FIG. 13 is a top view of the golf club head of FIG. 9;  
 FIG. 14 is a bottom view of the golf club head of FIG. 9;  
 FIG. 15 is a left side view of the golf club head of FIG. 9;  
 FIG. 16 is a right side view of the golf club head of FIG. 9;

FIG. 17 is a top perspective view of a third embodiment of the golf club head;

FIG. 18 is a bottom perspective view of the golf club head of FIG. 17;

FIG. 19 is a front elevational view of the golf club head of FIG. 17;

FIG. 20 is a rear elevational view of the golf club head of FIG. 17;

FIG. 21 is a top view of the golf club head of FIG. 17;

FIG. 22 is a bottom view of the golf club head of FIG. 17;

FIG. 23 is a left side view of the golf club head of FIG. 17;

and,

FIG. 24 is a right side view of the golf club head of FIG. 17.

The broken lines shown on the golf club head forms no part of the claimed design.

**1 Claim, 21 Drawing Sheets**



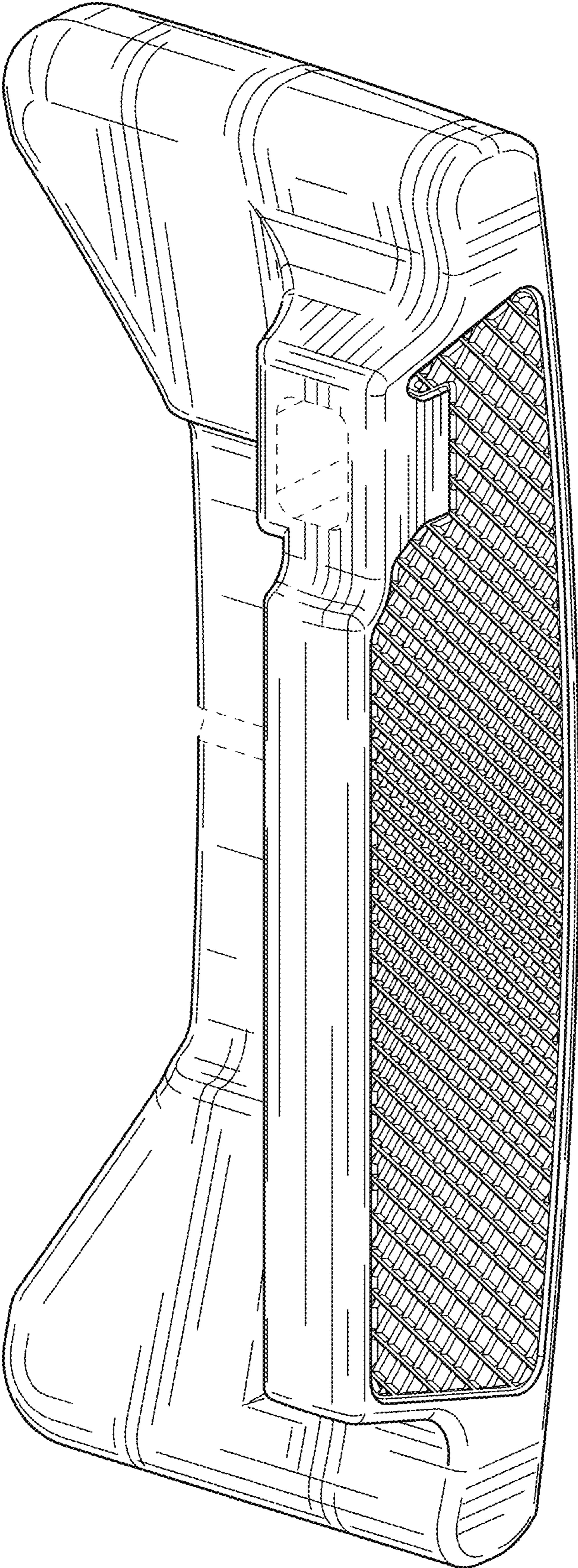

FIG. 1

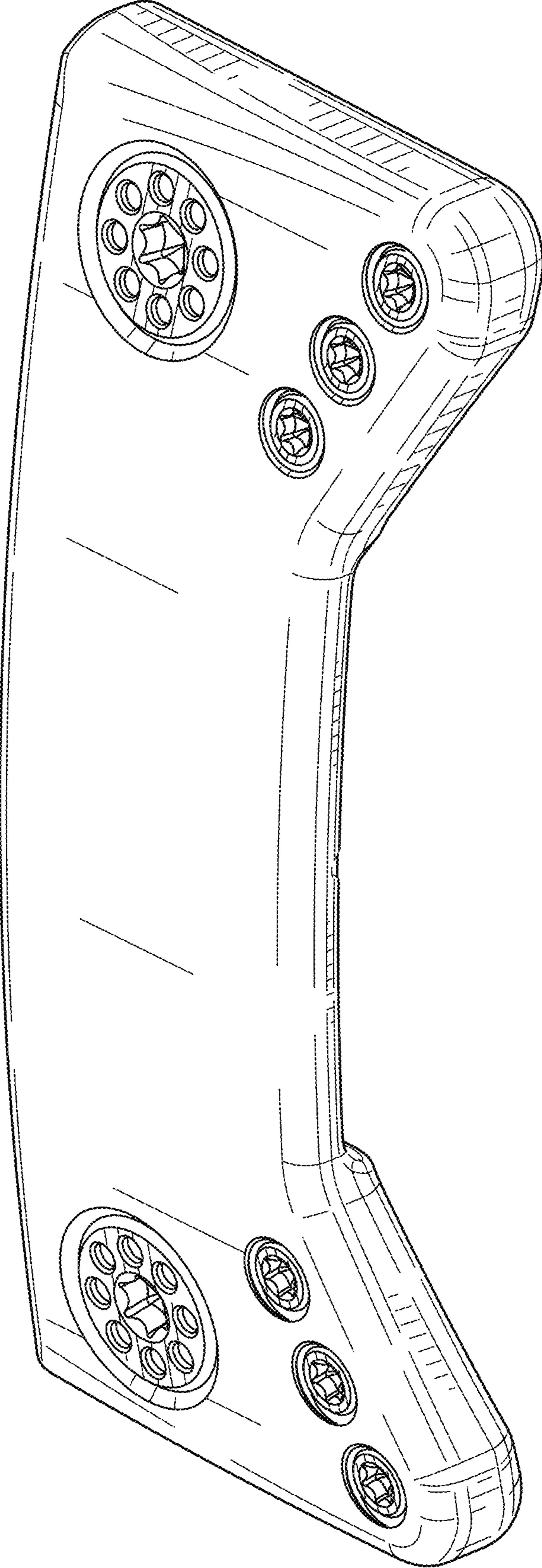

FIG. 2



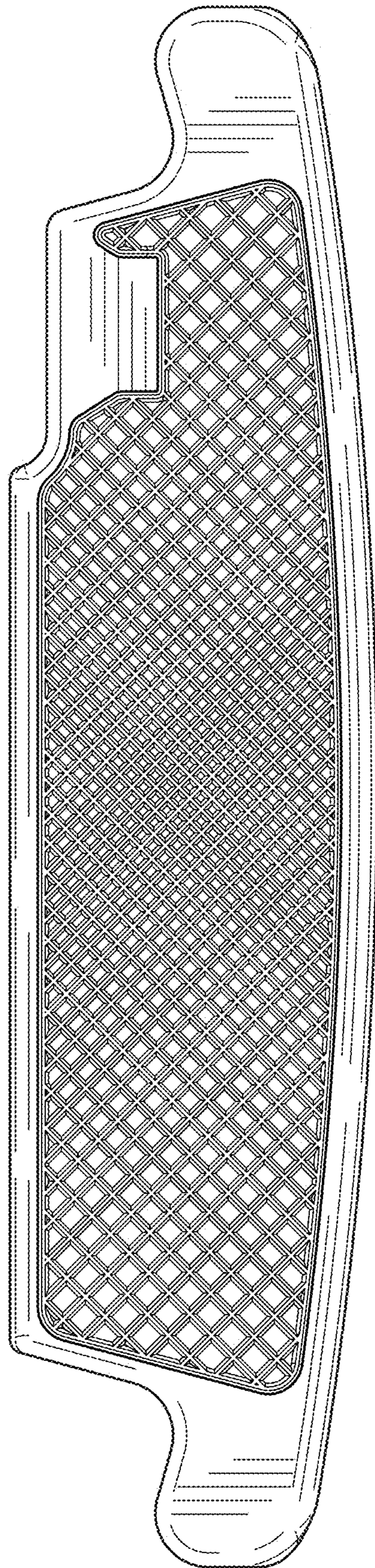

FIG. 3

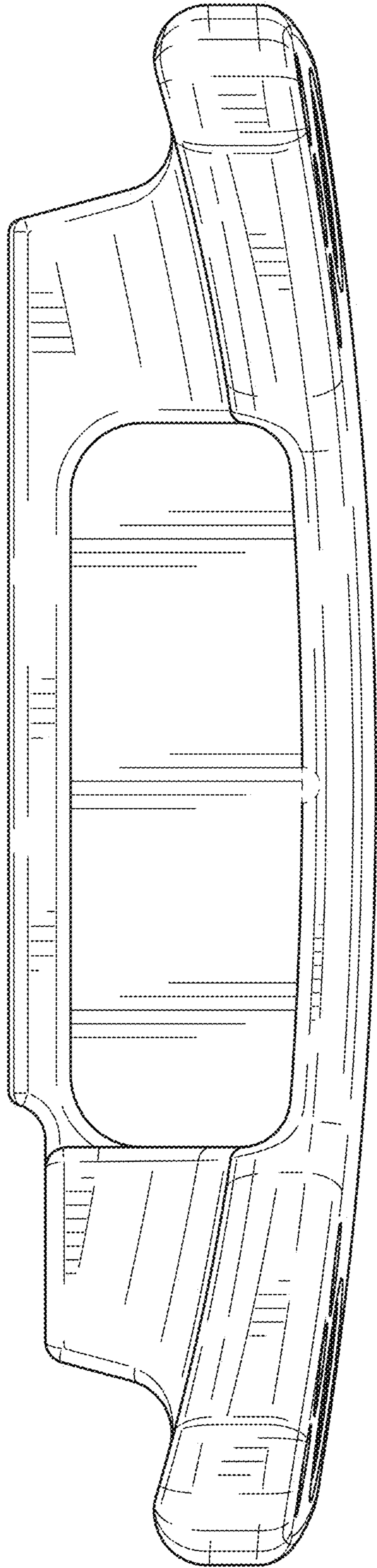

FIG. 4



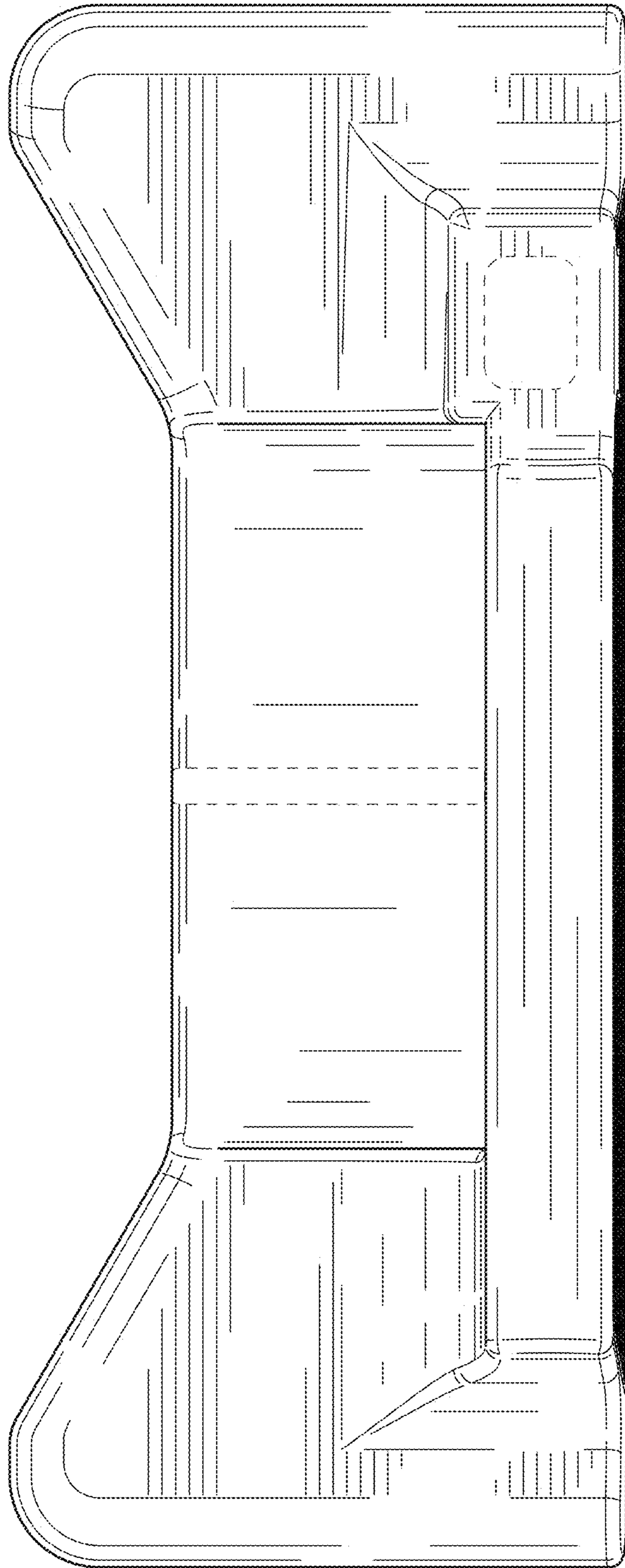

FIG. 5



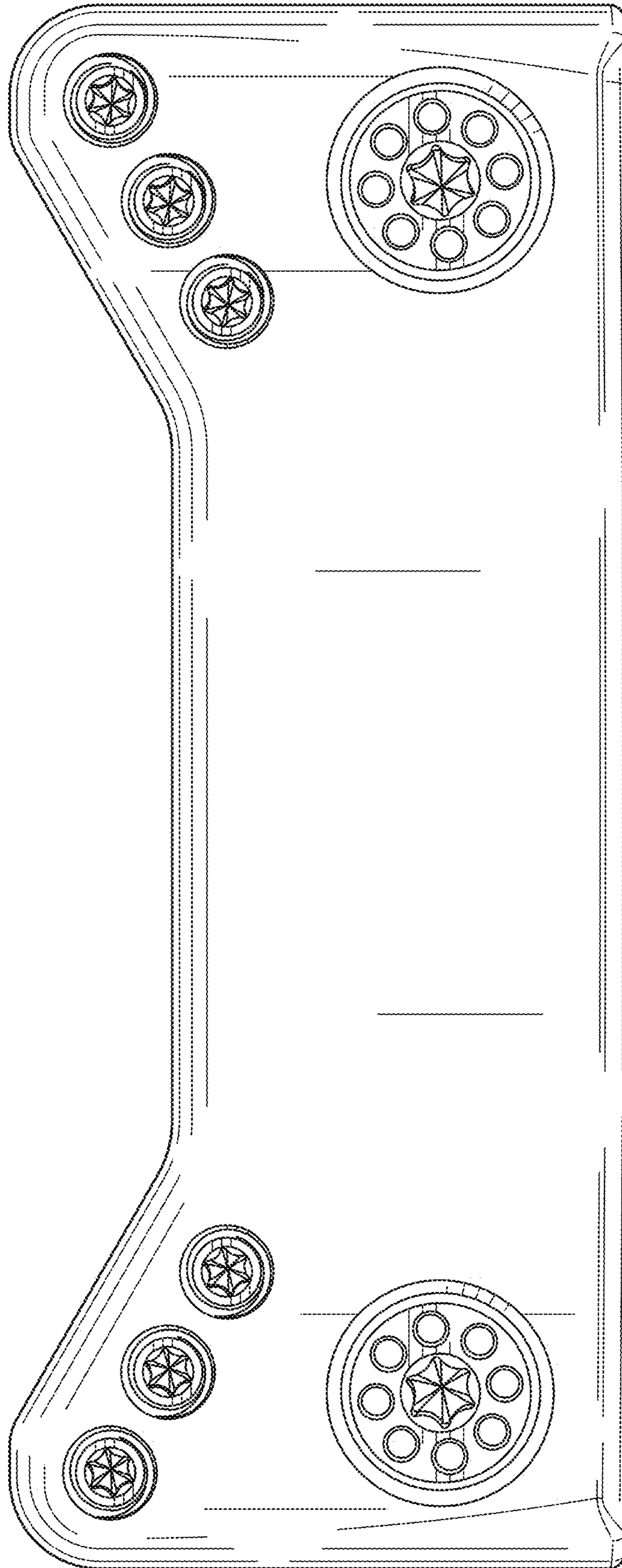

FIG. 6

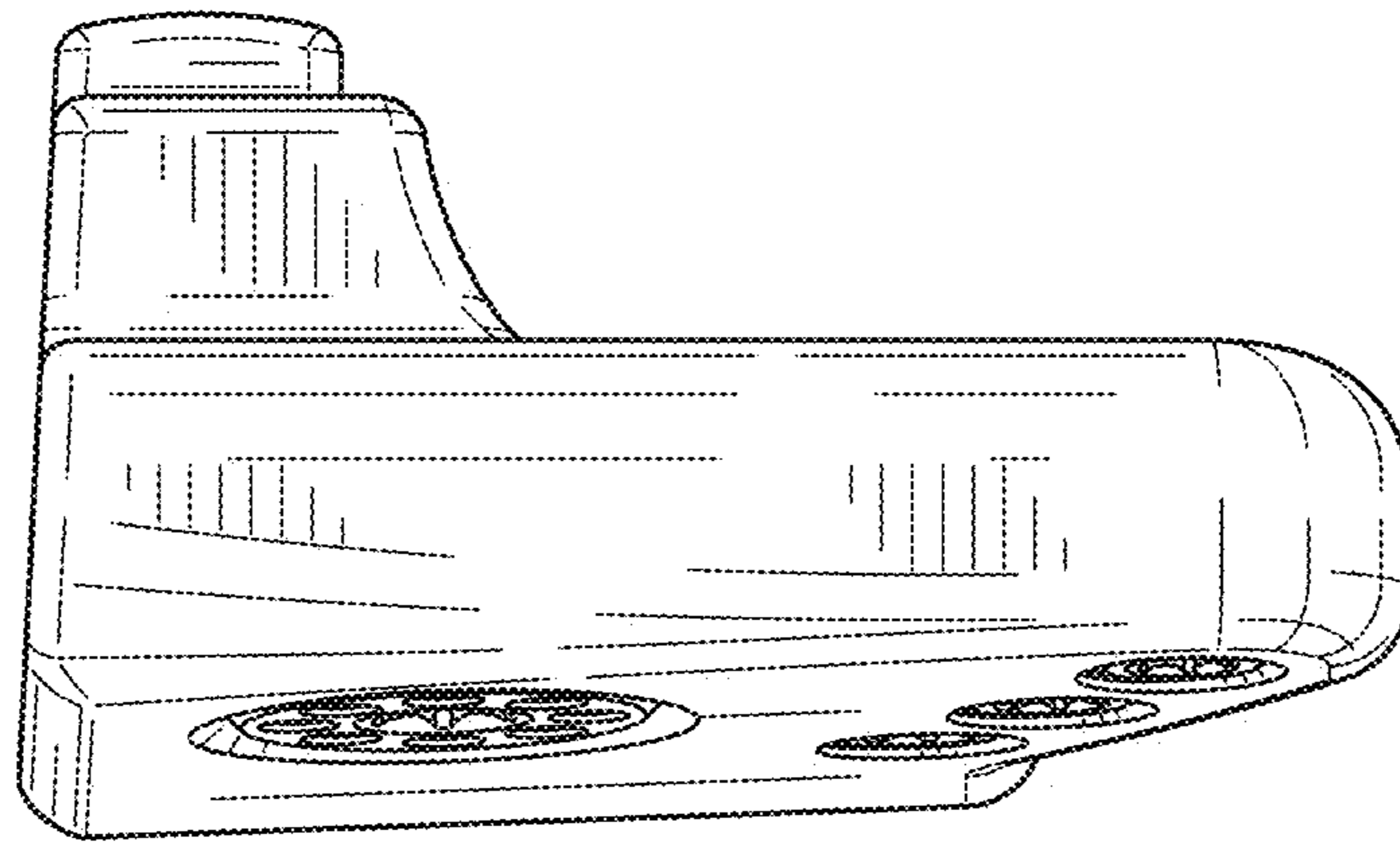

FIG. 7

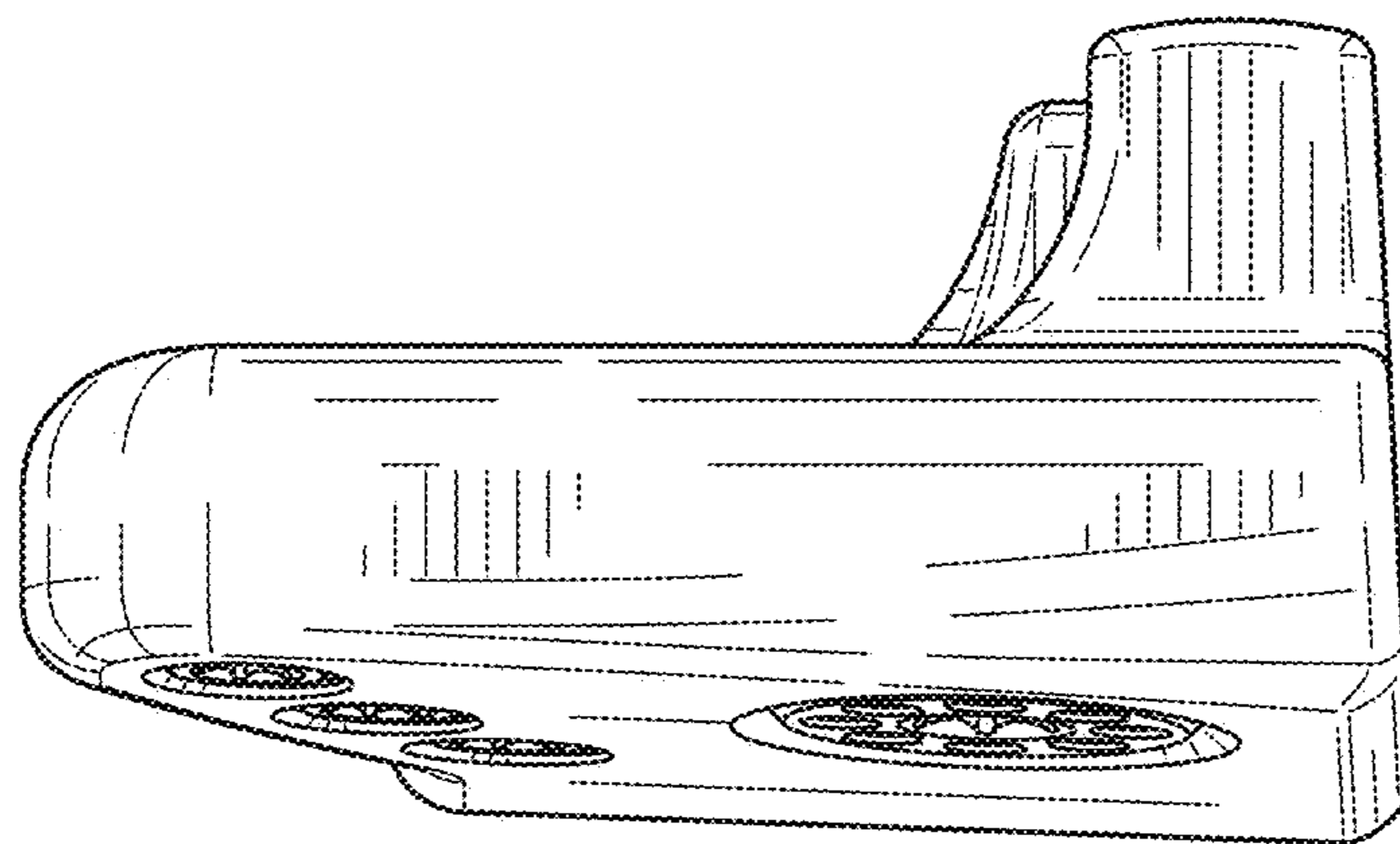

FIG. 8



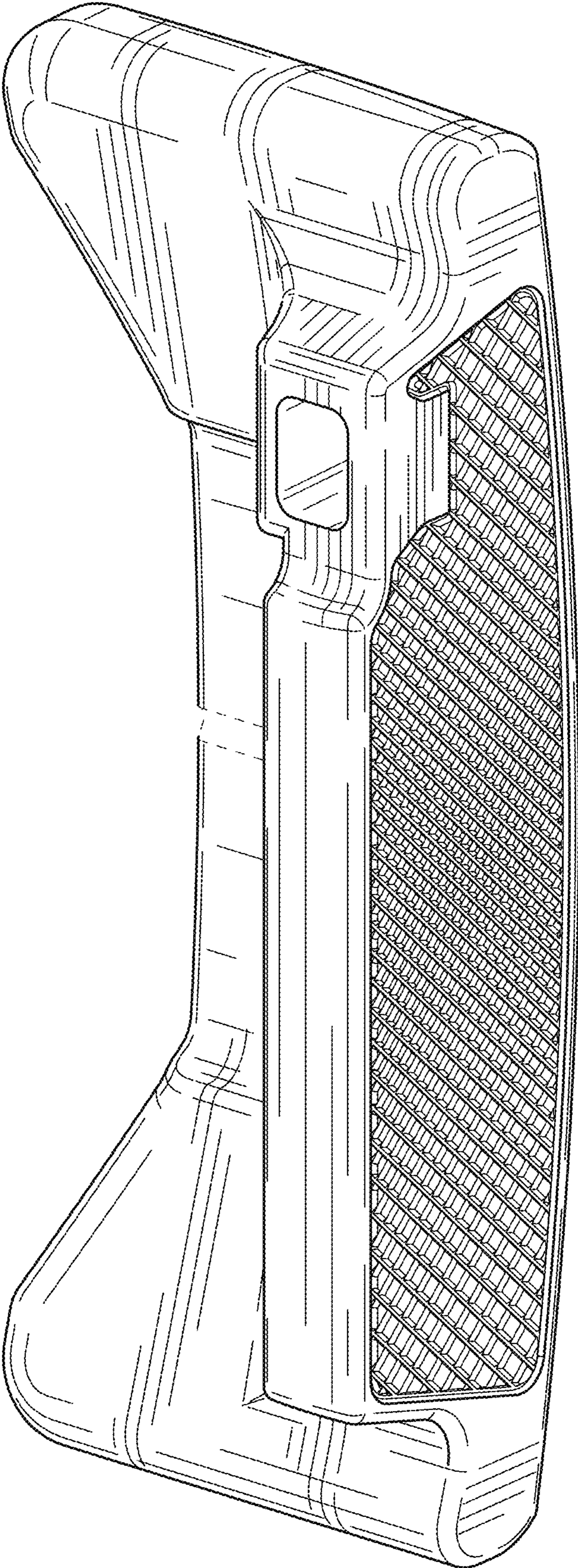

FIG. 9

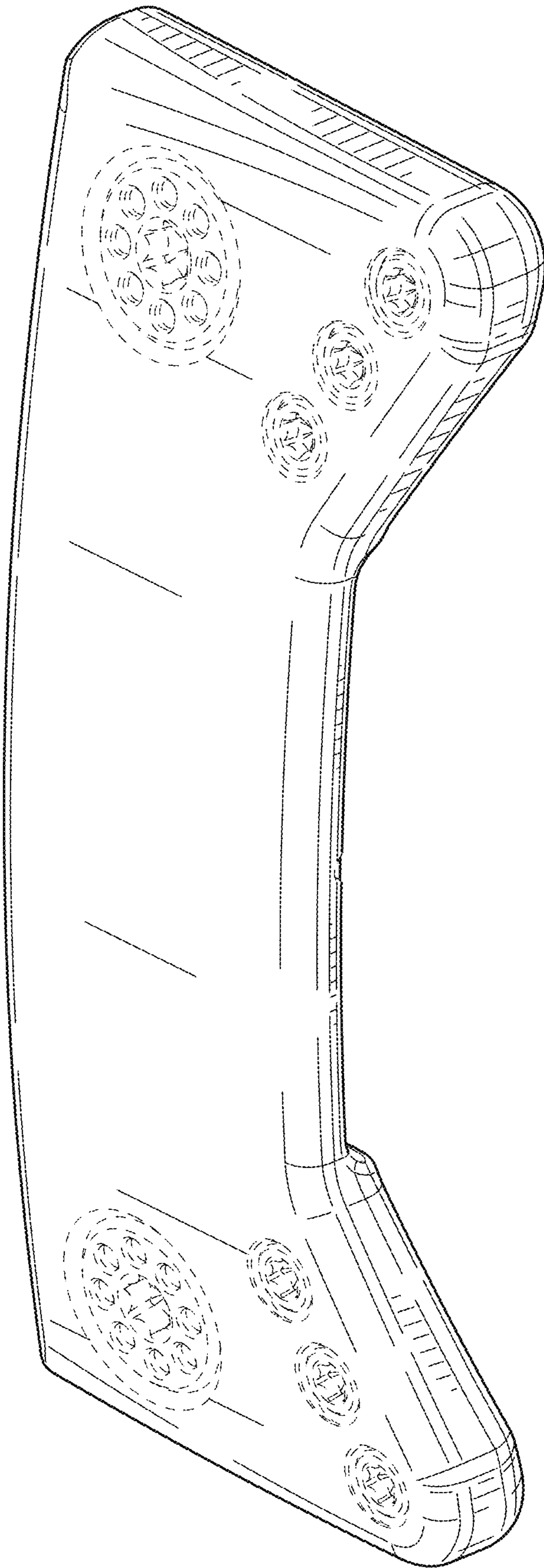

FIG. 10



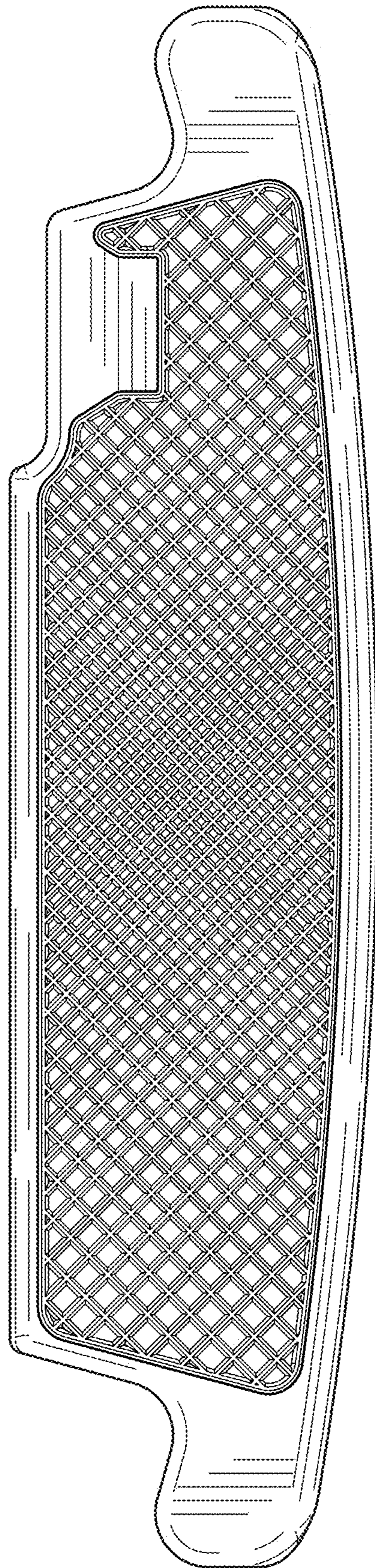

FIG. 11

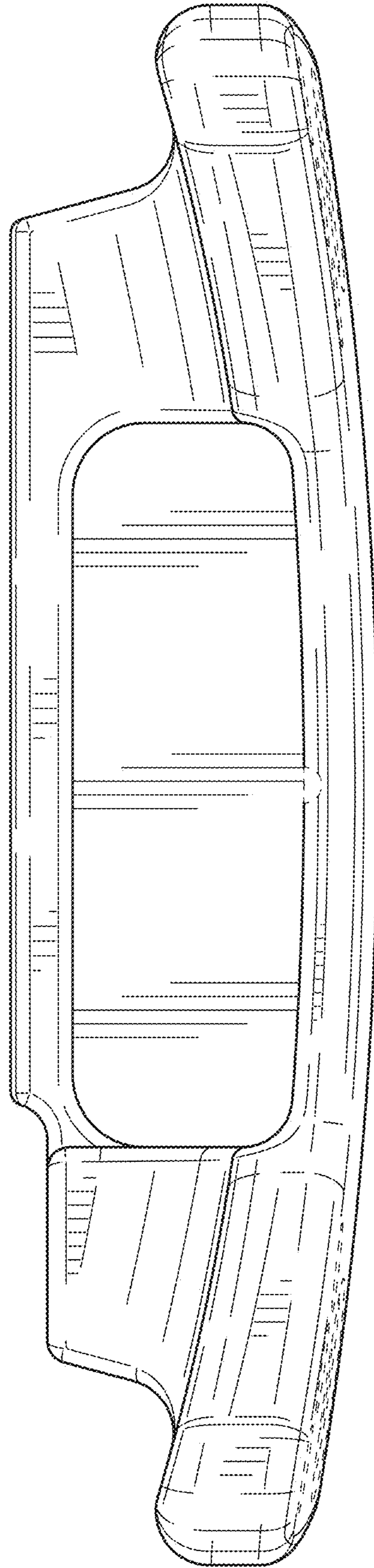

FIG. 12



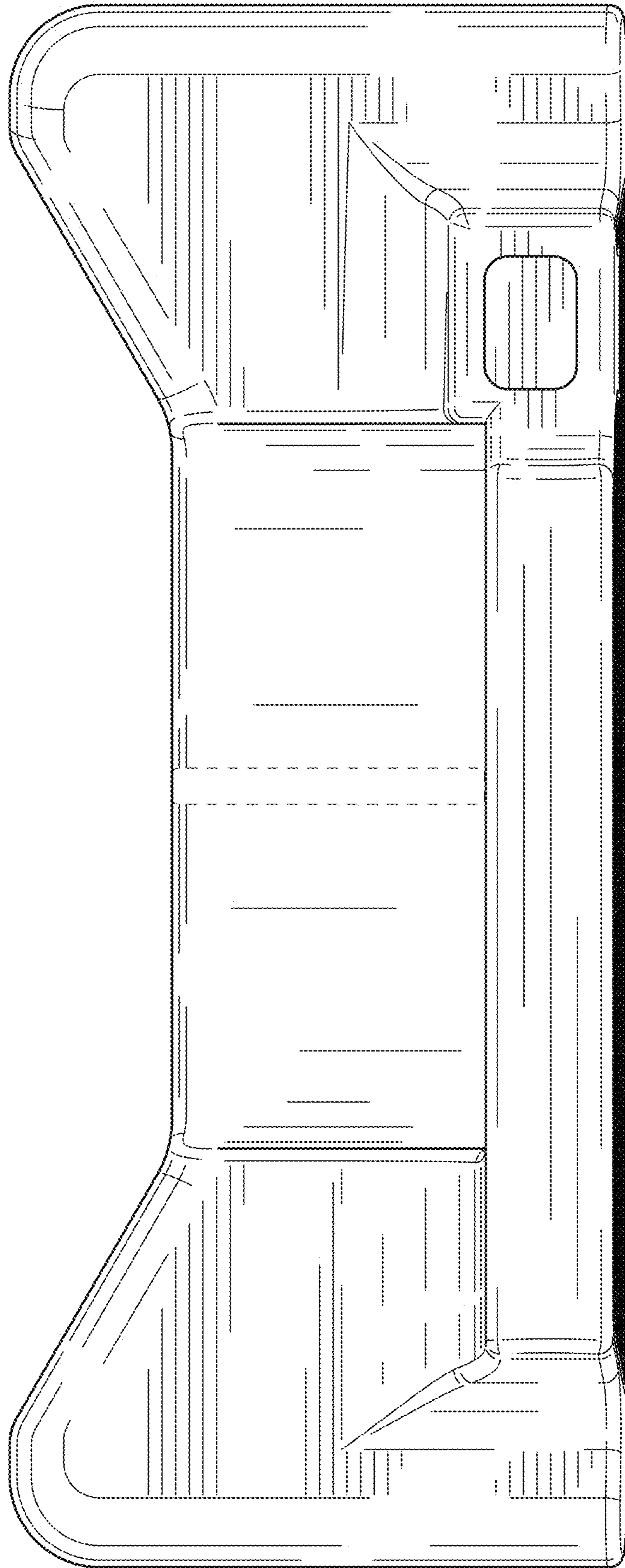

FIG. 13

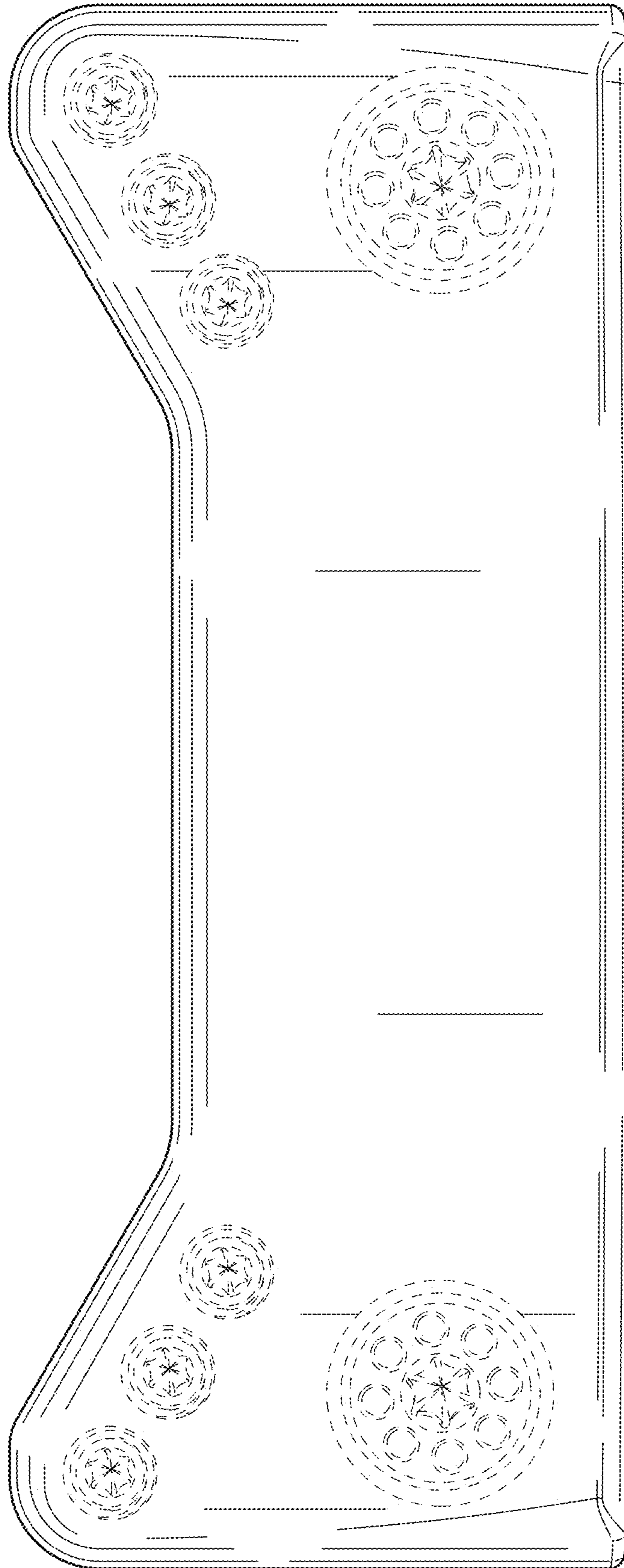

FIG. 14



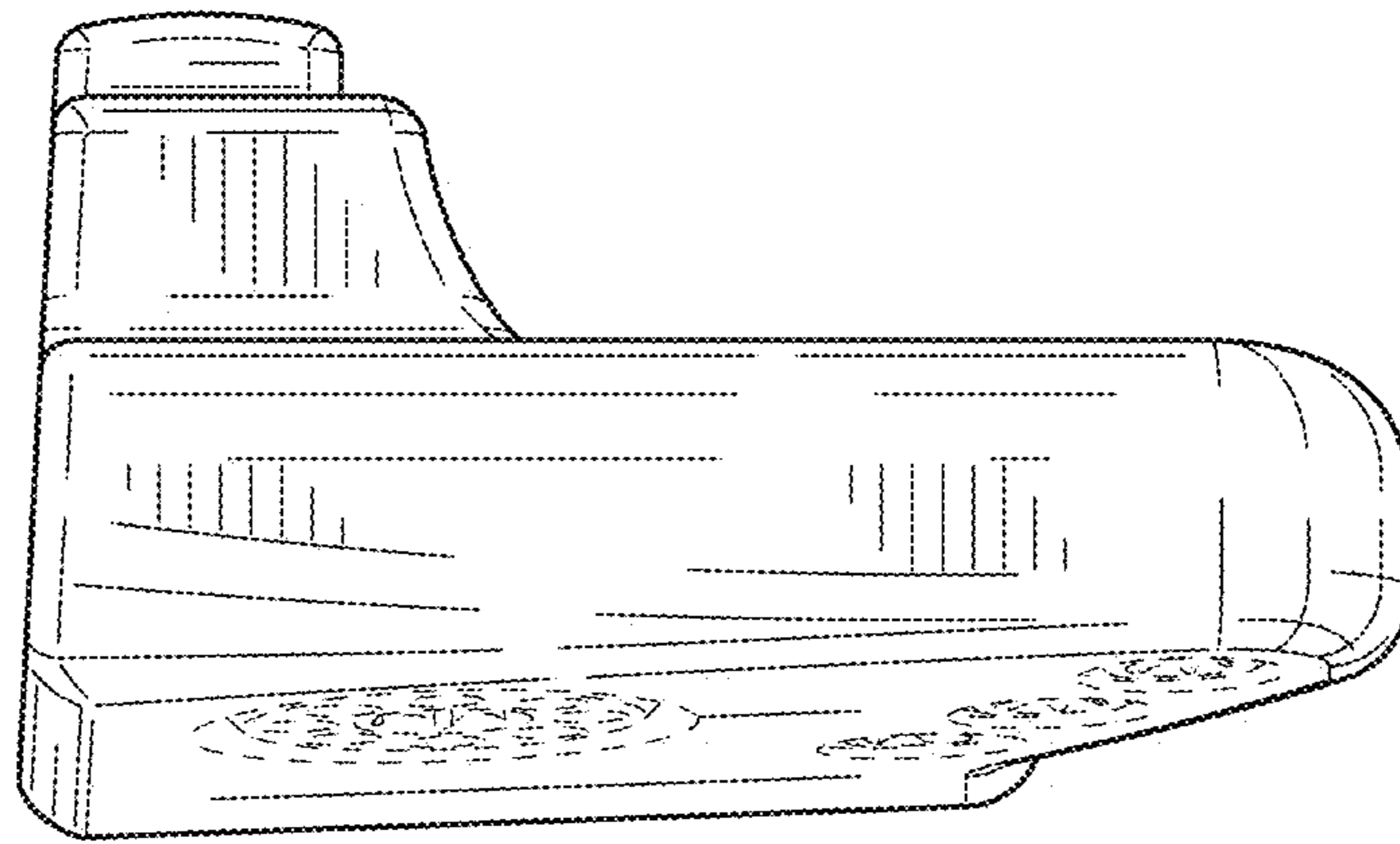

FIG. 15

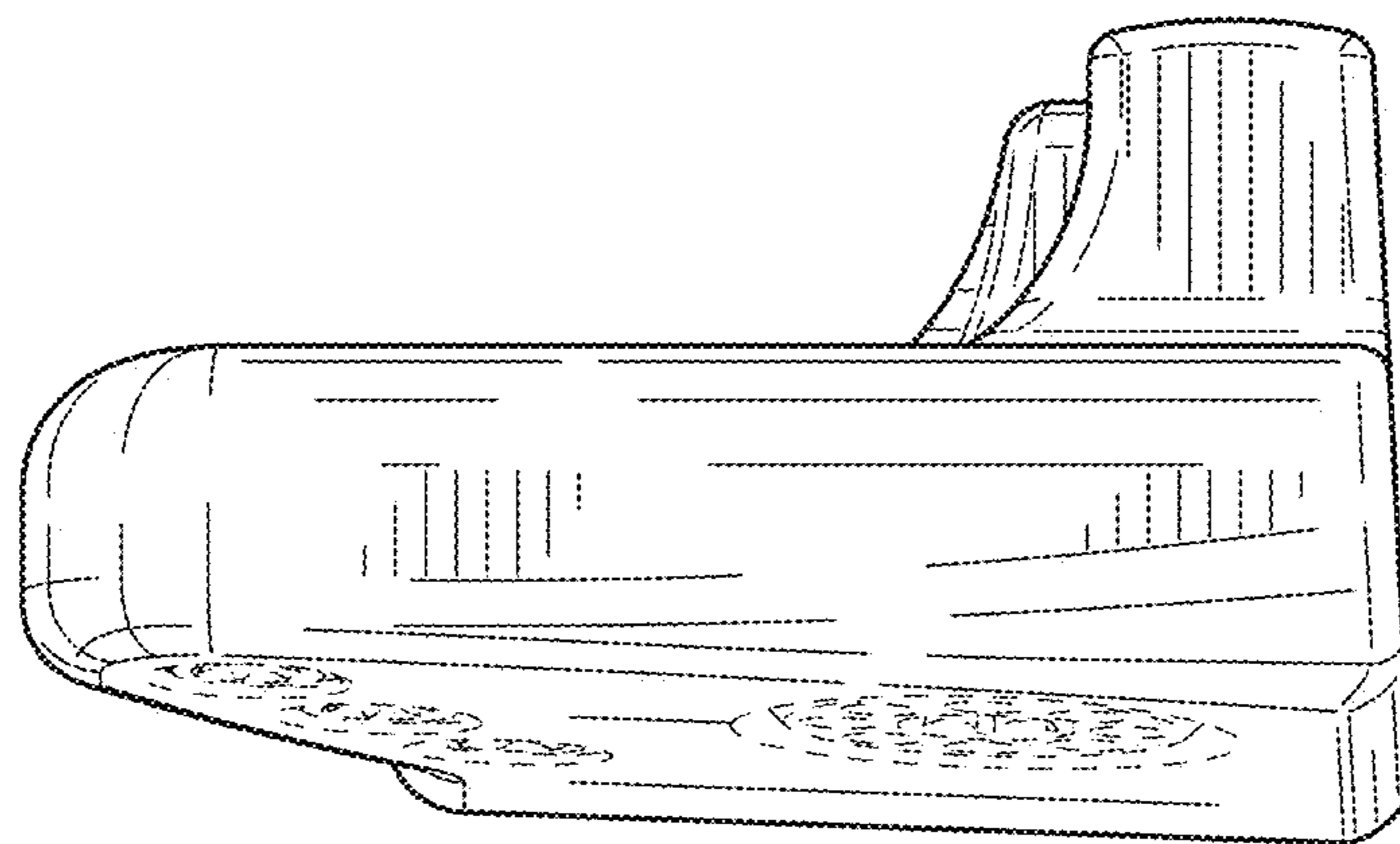

FIG. 16

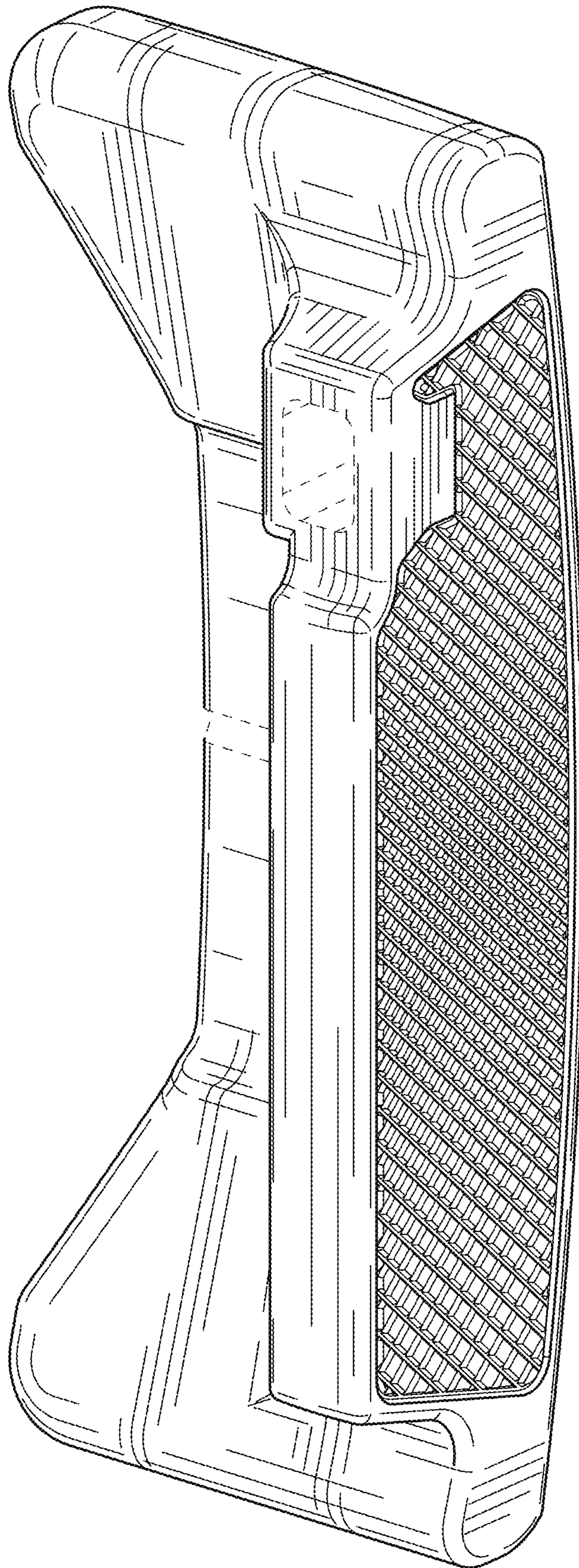

FIG. 17



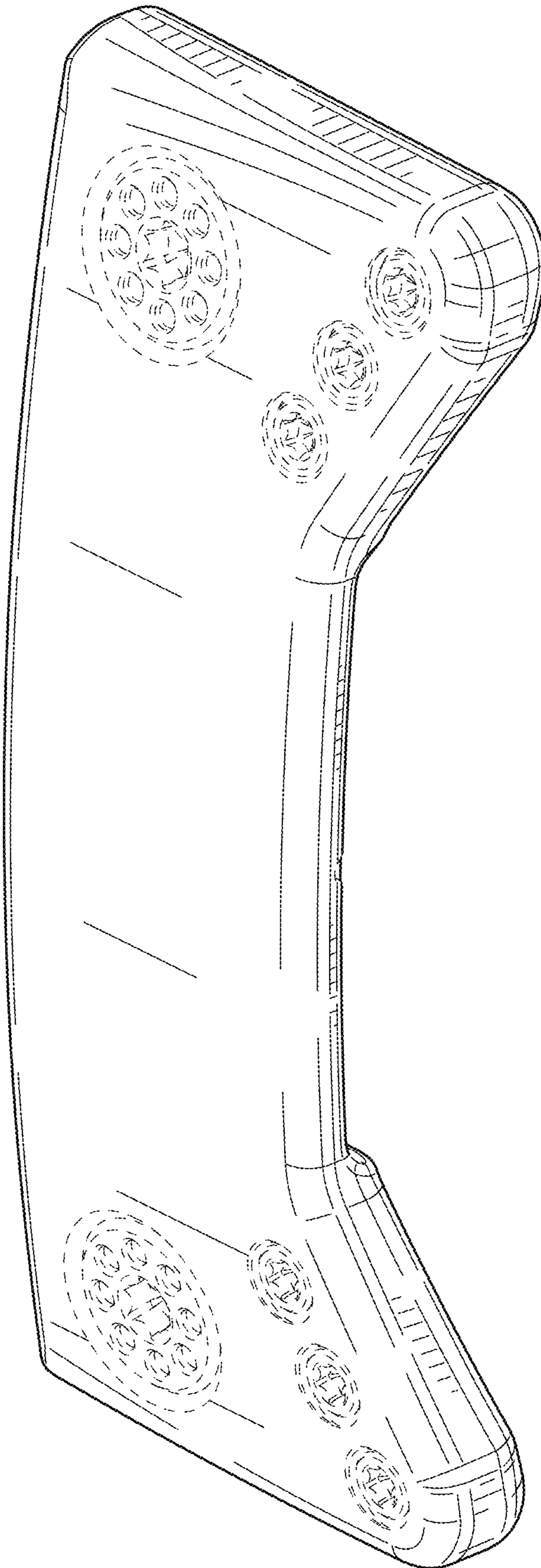

FIG. 18

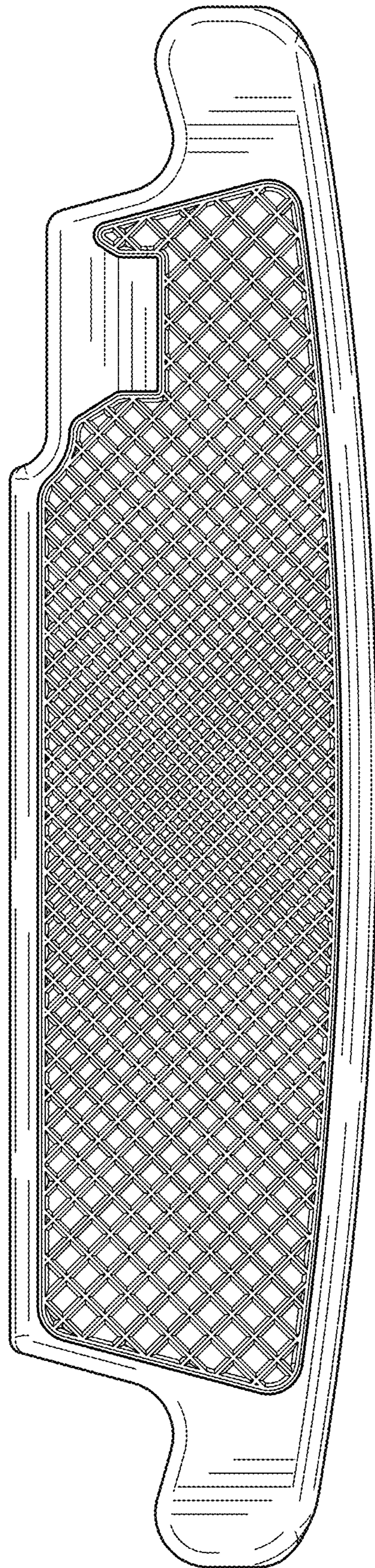

FIG. 19



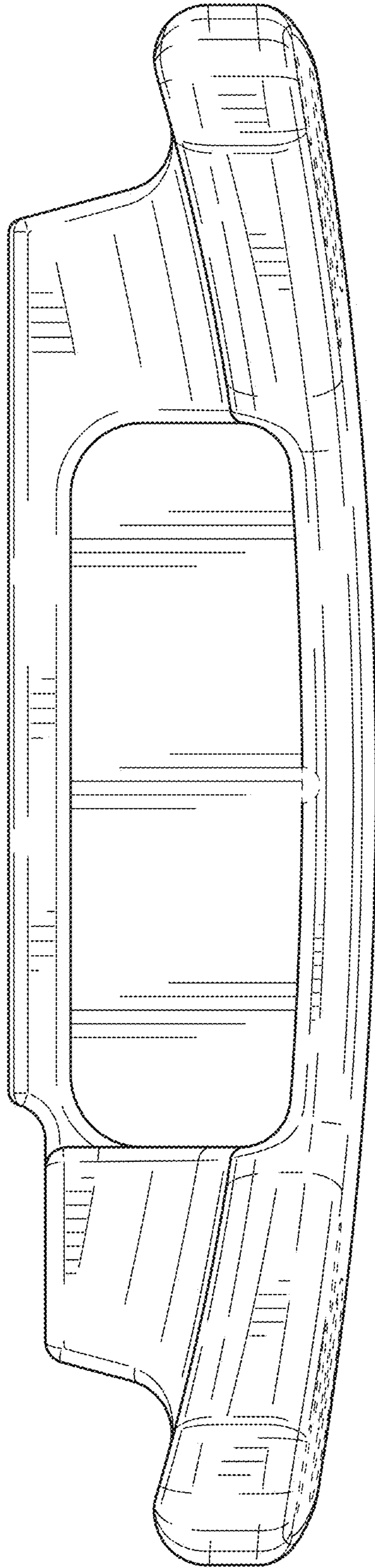

FIG. 20

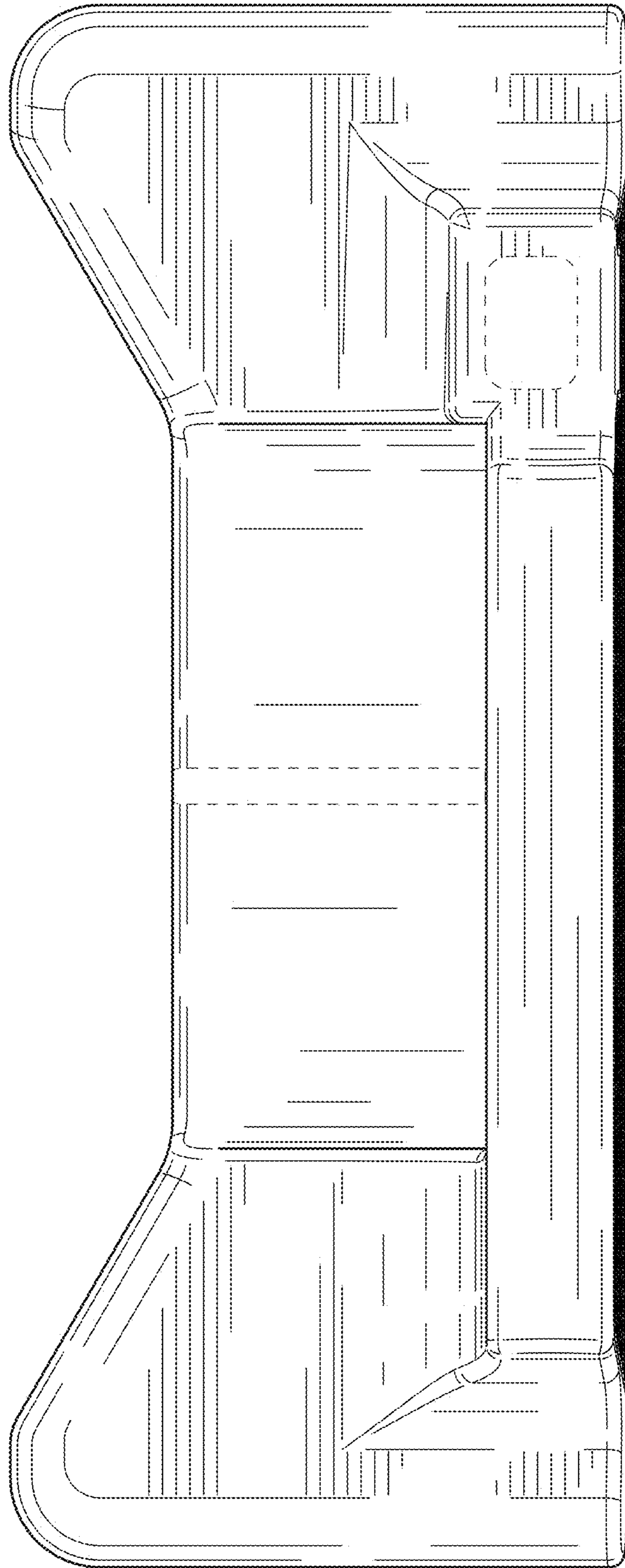

FIG. 21



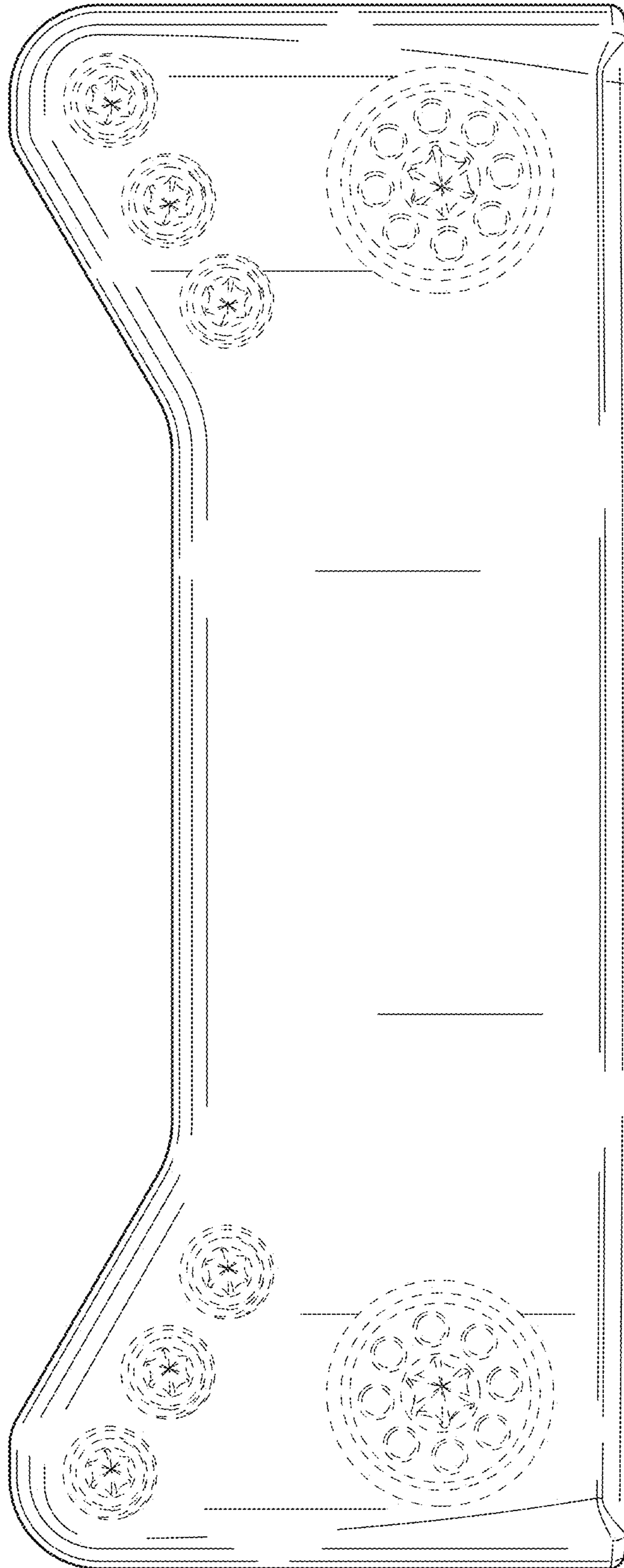

FIG. 22

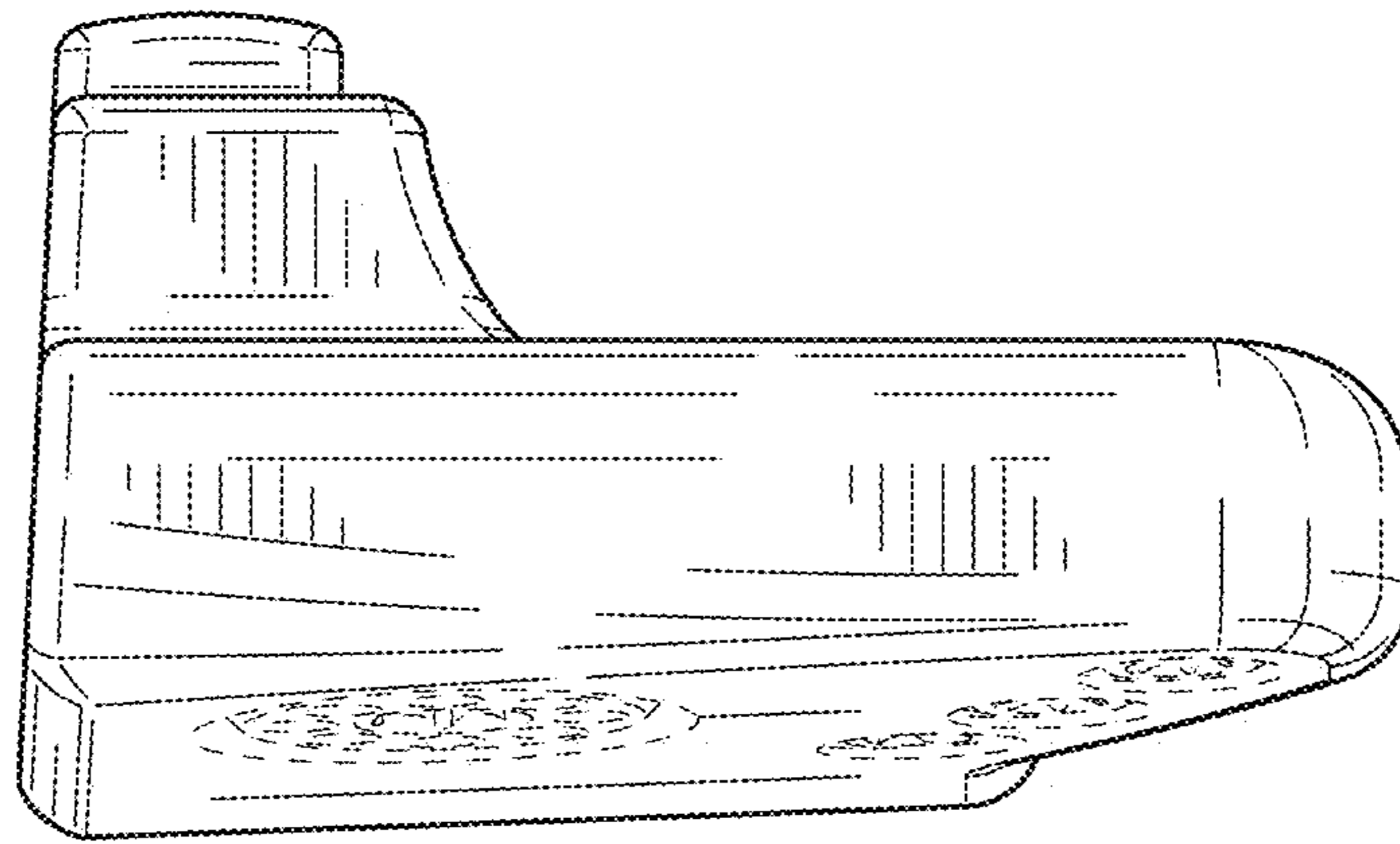

FIG. 23

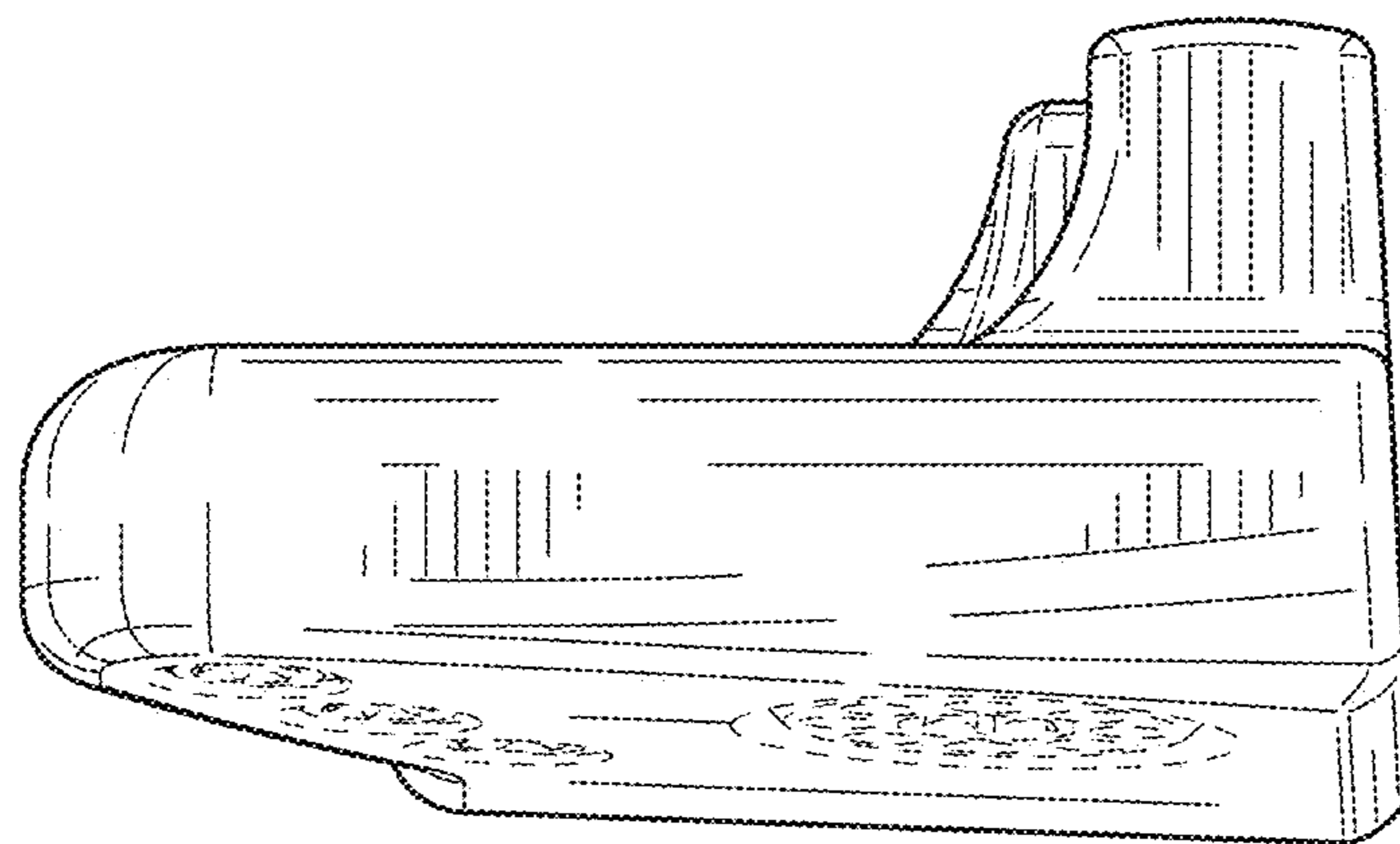

FIG. 24