



US00D910614S

(12) **United States Design Patent** (10) **Patent No.:** **US D910,614 S**
Lee et al. (45) **Date of Patent:** **** Feb. 16, 2021**

(54) **NOTEBOOK LAPTOP COMPUTER**

(71) Applicant: **LG ELECTRONICS INC.**, Seoul (KR)

(72) Inventors: **Heechang Lee**, Seoul (KR); **Junghyun Min**, Seoul (KR); **Gangho Woo**, Seoul (KR)

(73) Assignee: **LG ELECTRONICS INC.**, Seoul (KR)

(**) Term: **15 Years**

(21) Appl. No.: **35/507,589**

(22) Filed: **Apr. 19, 2019**

(80) **Hague Agreement Data**

Int. Filing Date: **Apr. 19, 2019**

Int. Reg. No.: **DM/203599**

Int. Reg. Date: **Apr. 19, 2019**

Int. Reg. Pub. Date: **Nov. 1, 2019**

(30) **Foreign Application Priority Data**

Nov. 13, 2018 (KR) 30-2018-0052448

(51) **LOC (13) Cl.** **14-03**

(52) **U.S. Cl.**
USPC **D14/315**

(58) **Field of Classification Search**
USPC D14/315-327
CPC H04N 19/176; H04N 19/182; H04N 19/44;
H04N 19/124; H04N 19/139; H04N 19/593; H04N 19/105; H04N 19/117;
H04N 19/12; H04N 19/159; H04N 19/172; H04N 19/174; H04N 19/186;
H04N 19/51; H04N 19/513; H04N 19/52;
H04N 19/61; H04N 19/82; H04N 1/32512; H04N 1/4413; H04N 1/4426;
H04N 1/4433; H04N 21/4122; H04N 21/4126; H04N 21/4307; H04N 2201/0039; H04N 2201/0055; H04N 2201/0094; H04N 5/2353; H04N 5/2355;
H04N 19/107; H04N 19/109; H04N 19/11; H04N 19/115; H04N 19/126;
H04N 19/129; H04N 19/13; H04N

19/132; H04N 19/136; H04N 19/137;
H04N 19/14; H04N 19/154; H04N 19/156; H04N 19/166; H04N 19/177;
H04N 19/18; H04N 19/184; H04N 19/192; H04N 19/42; H04N 19/433;
H04N

(Continued)

(56) **References Cited**

U.S. PATENT DOCUMENTS

D763,249 S * 8/2016 Lee D14/315
D774,505 S * 12/2016 Akana D14/318

(Continued)

Primary Examiner — Khawaja Anwar

(74) *Attorney, Agent, or Firm* — Birch, Stewart, Kolasch & Birch, LLP

(57) **CLAIM**

The ornamental design for a notebook laptop computer, as shown and described.

DESCRIPTION

1. Notebook laptop computer

1.1 : Perspective

1.2 : Front

1.3 : Back

1.4 : Left

1.5 : Right

1.6 : Top

1.7 : Bottom

1.8 : Perspective

1.9 : Front

1.10 : Back

1.11 : Left

1.12 : Right

1.13 : Top

1.14 : Bottom

The broken lines indicate portions of the notebook laptop computer that form no part of the claimed design.

1 Claim, 6 Drawing Sheets

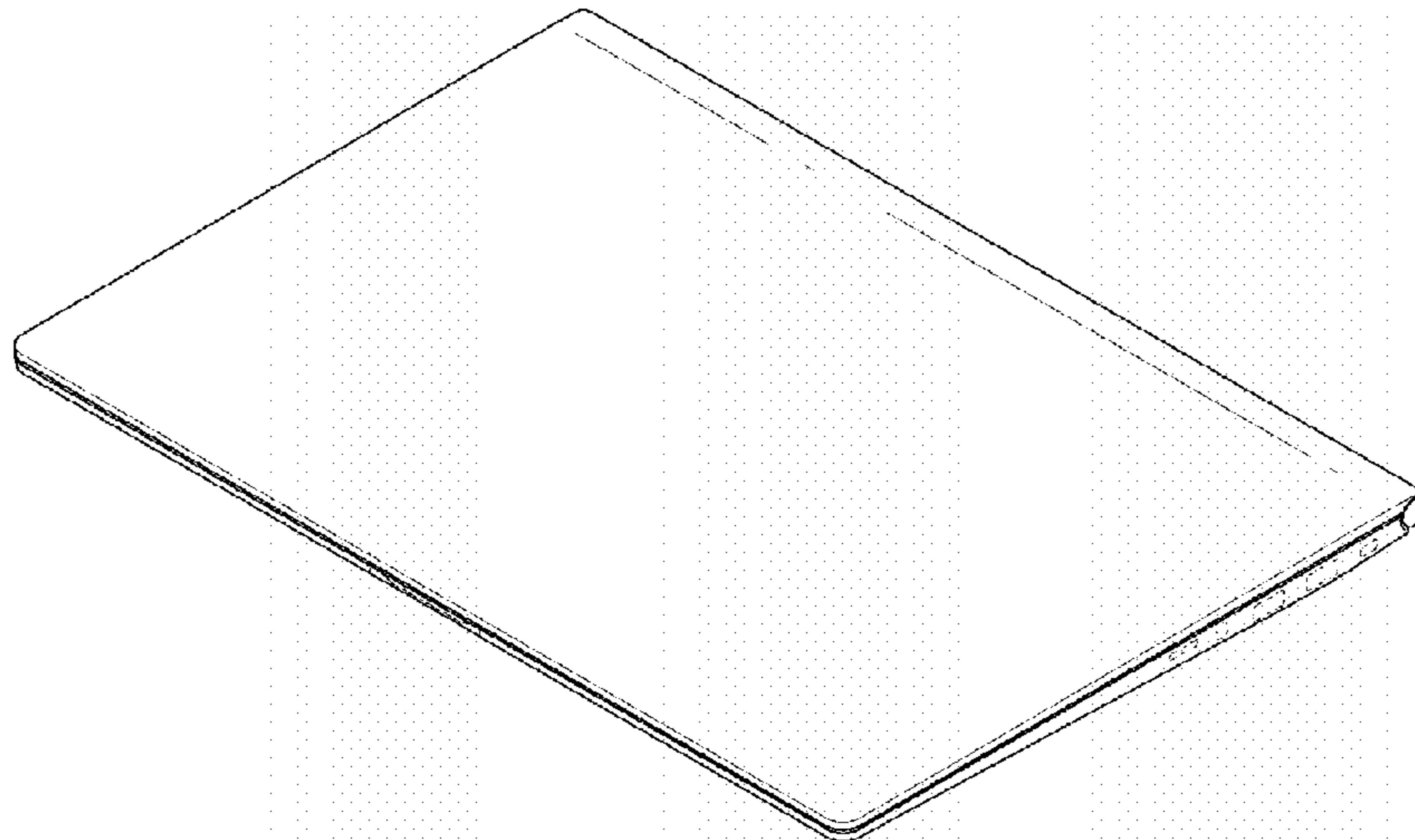

(58) **Field of Classification Search**

CPC 19/46; H04N 19/463; H04N 19/503; H04N 19/521; H04N 19/523; H04N 19/527; H04N 19/53; H04N 19/533; H04N 19/537; H04N 19/55; H04N 19/577; H04N 19/583; H04N 19/65; H04N 19/80; H04N 19/85; H04N 19/86; H04N 19/865; H04N 19/89; H04N 19/895; H04N 19/98; H04N 1/00103; H04N 1/00204; H04N 1/00315; H04N 1/00342; H04N 1/00925; H04N 1/407; H04N 1/444; H04N 1/60; H04N 1/6077; H04N 1/628; H04N 21/2187; H04N 21/232; H04N 21/2368; H04N 21/242; H04N 21/2541; H04N 21/2665; H04N 21/41407; H04N 21/43635; H04N 21/4402; H04N 21/4854; H04N 21/488; H04N 21/6125; H04N 21/6181; H04N 21/6543; H04N 21/6582; H04N 21/812; H04N 21/8133;

H04N 21/816; H04N 2201/0084; H04N 2201/3205; H04N 5/2254; H04N 5/2258; H04N 5/23212; H04N 5/23219; H04N 5/2327; H04N 5/772; H04N 5/781; H04N 7/183; H04N 9/04; H04N 9/3161; H04N 9/3164; H04N 9/317; H04N 9/3194; H04N 9/67; H04N 9/735; G06N 20/00
See application file for complete search history.

(56)

References Cited

U.S. PATENT DOCUMENTS

D795,245	S	*	8/2017	Seoc	D14/315
D810,069	S	*	2/2018	Hishiki	D14/316
D810,071	S	*	2/2018	Hishiki	D14/318
D826,927	S	*	8/2018	Lee	D14/315
D829,707	S	*	10/2018	Tin	D14/315
D837,202	S	*	1/2019	Lee	D14/315
D890,746	S	*	7/2020	Moon	D14/315

* cited by examiner

1.1

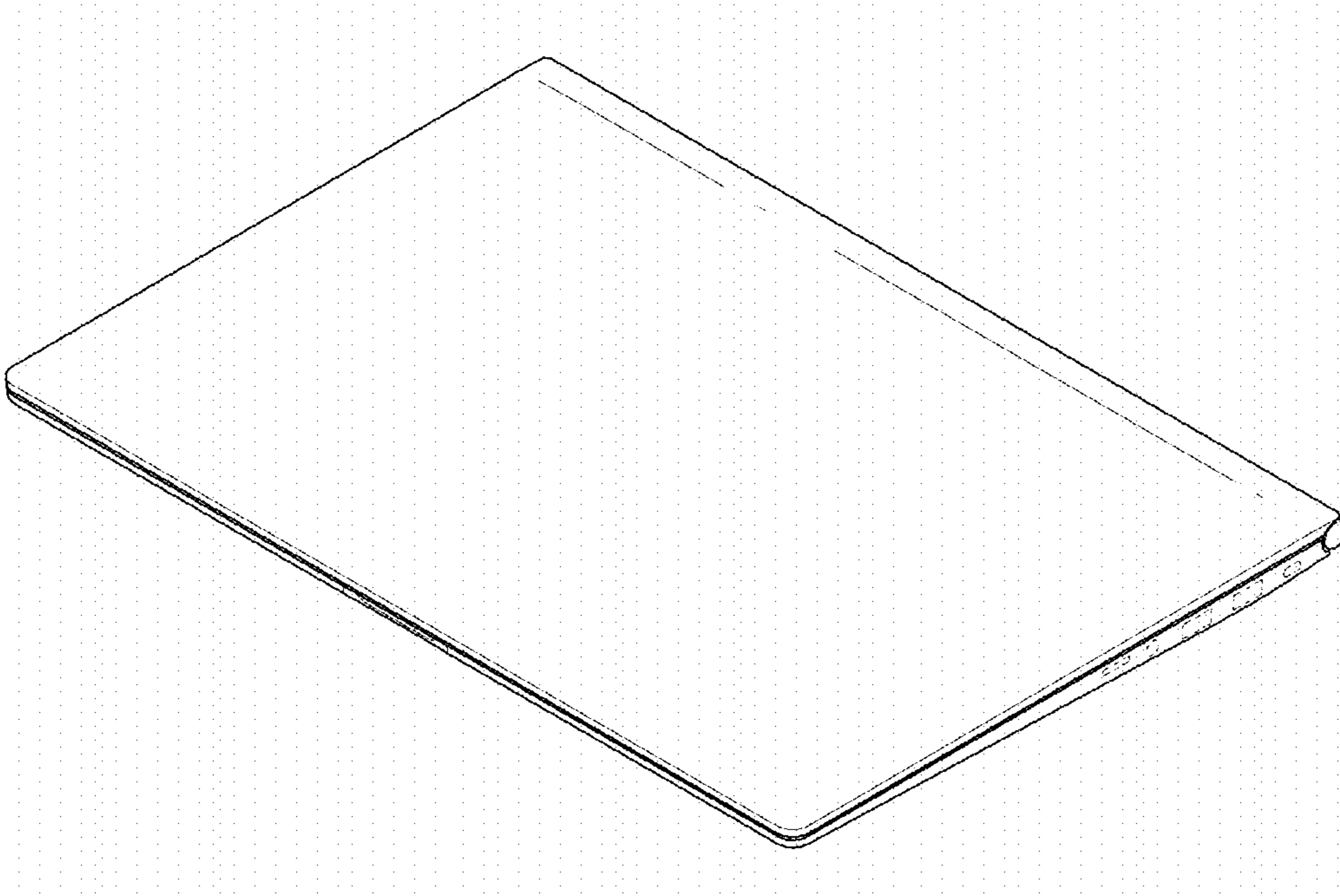

1.2

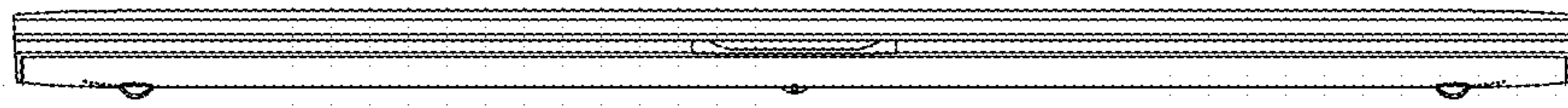

1.3

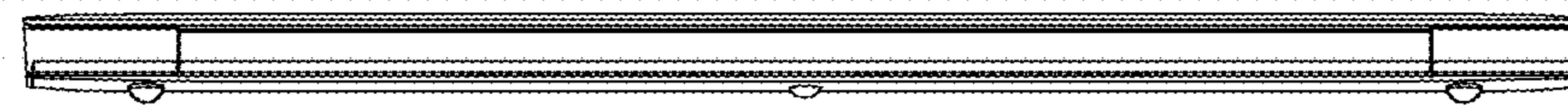

1.4

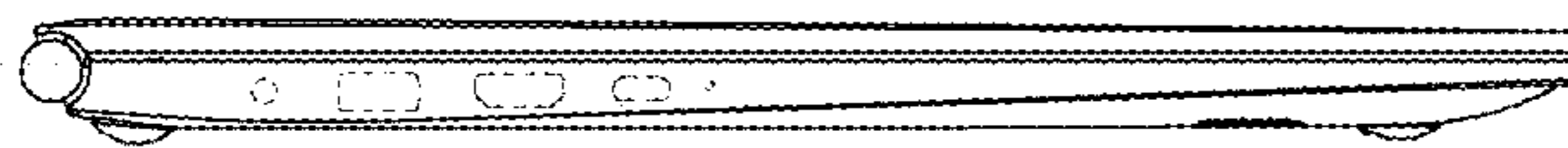

1.5

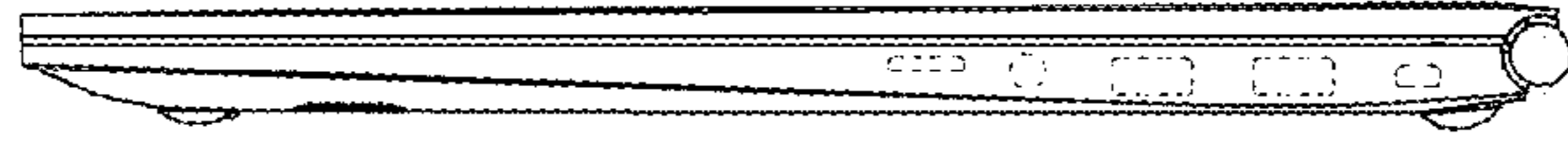

1.6

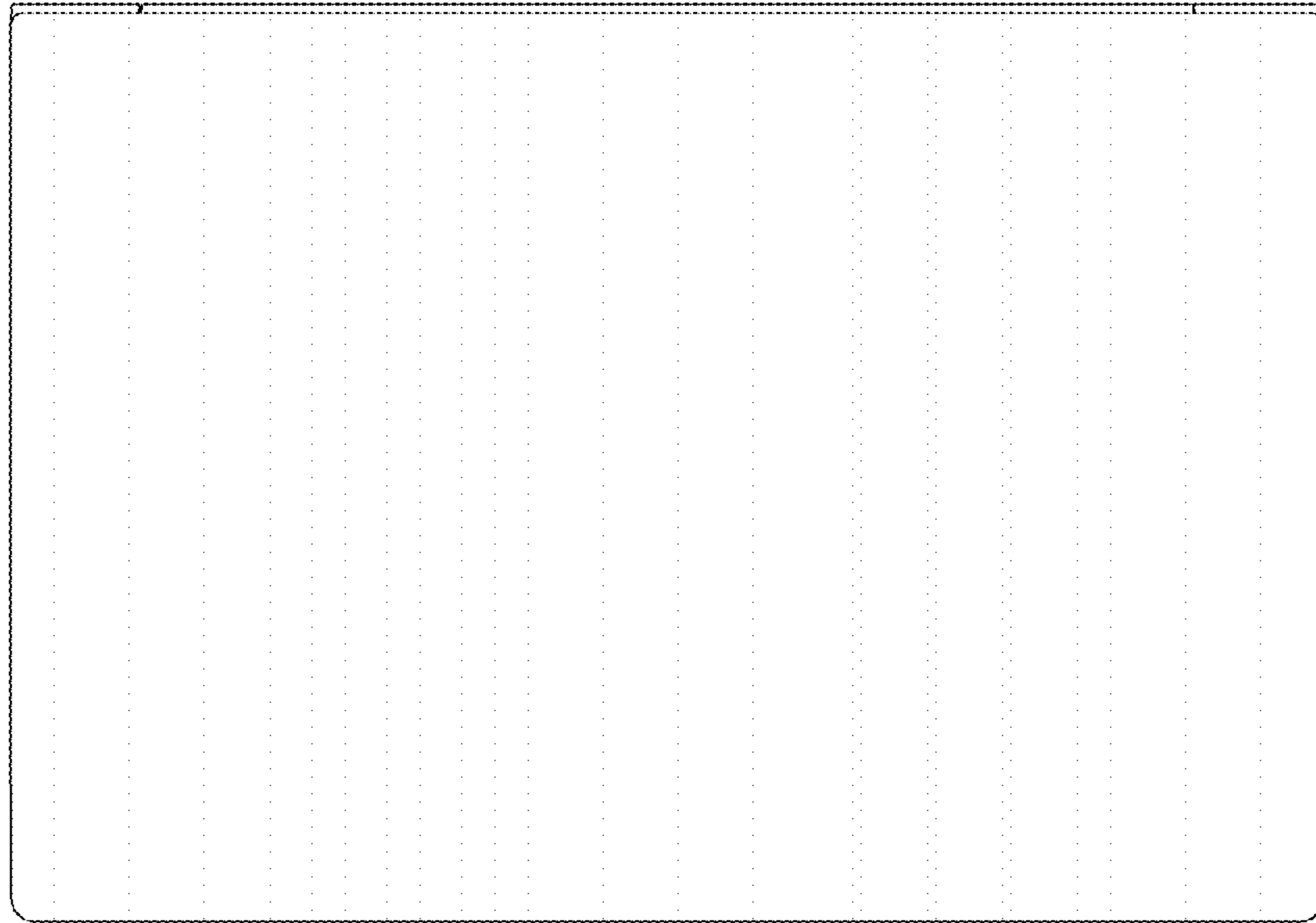

1.7

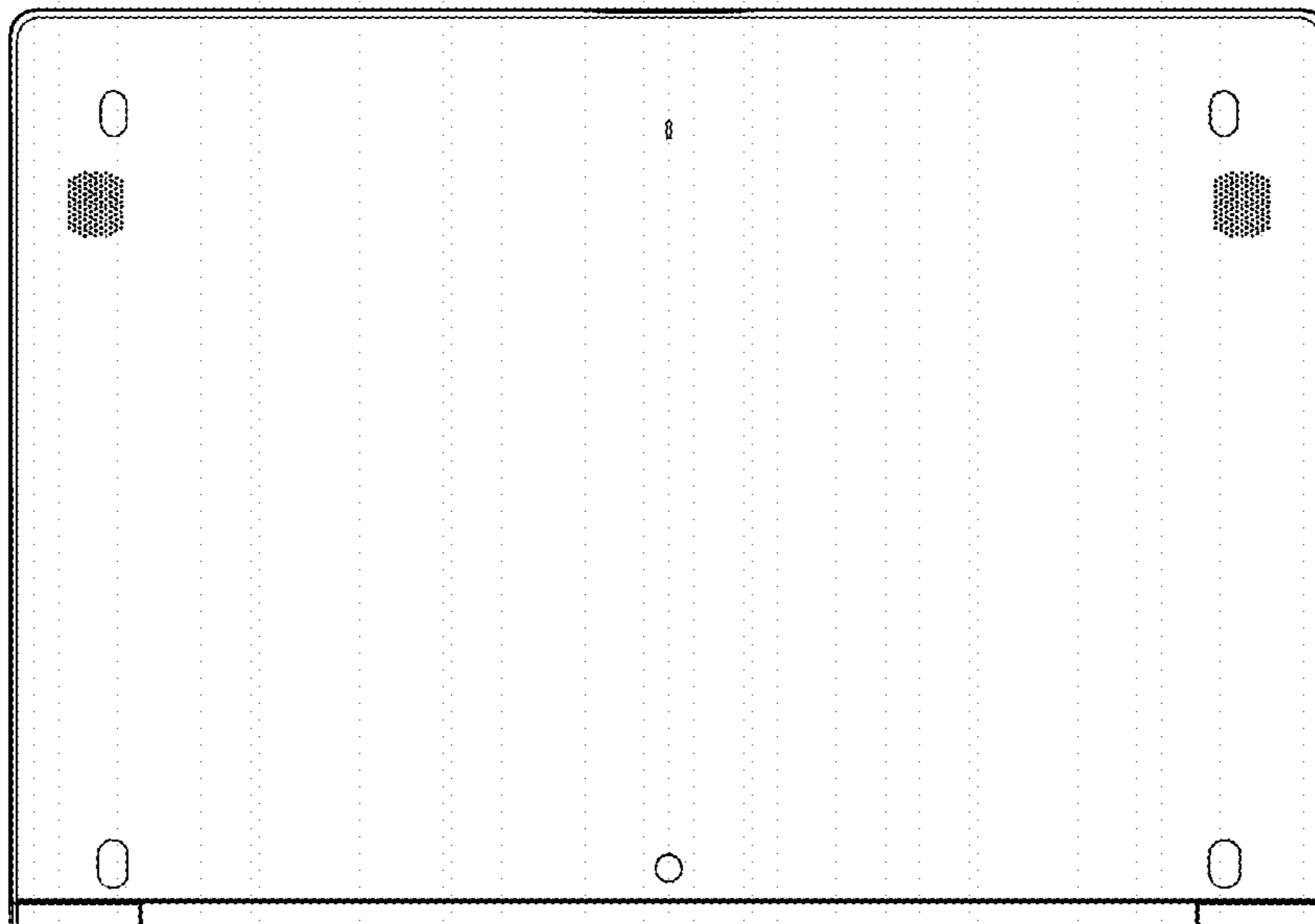

1.8

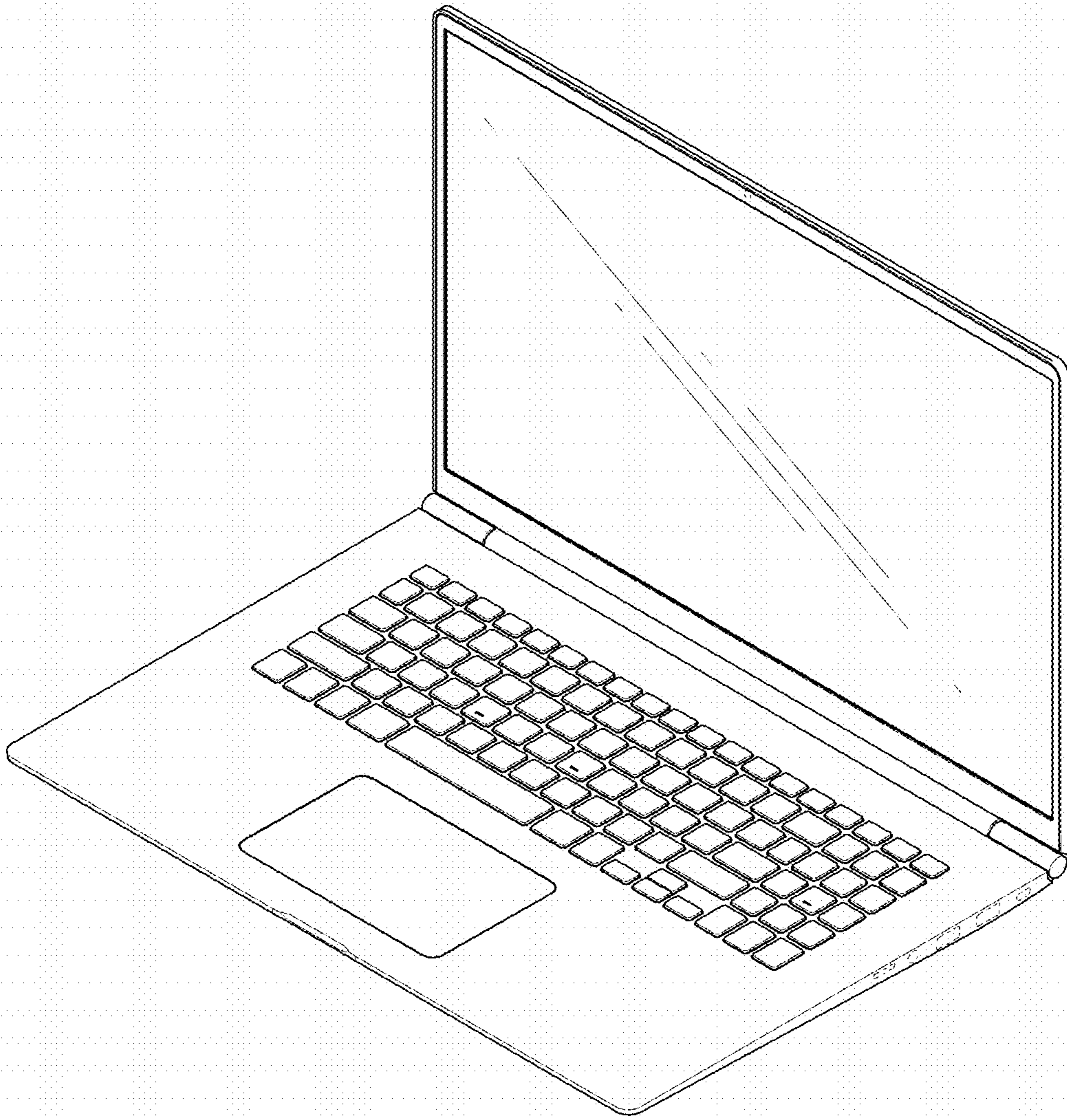

1.9

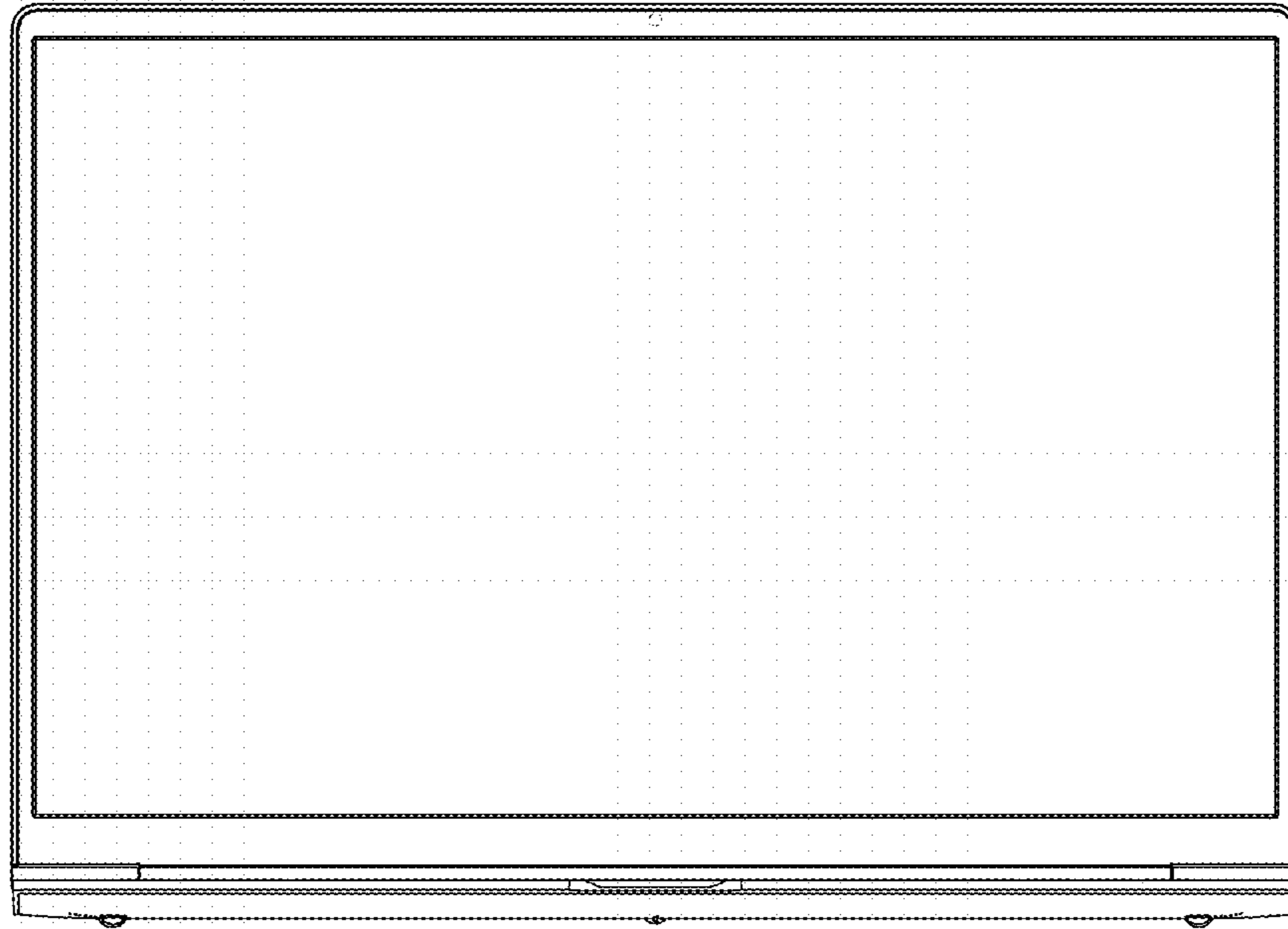

1.10

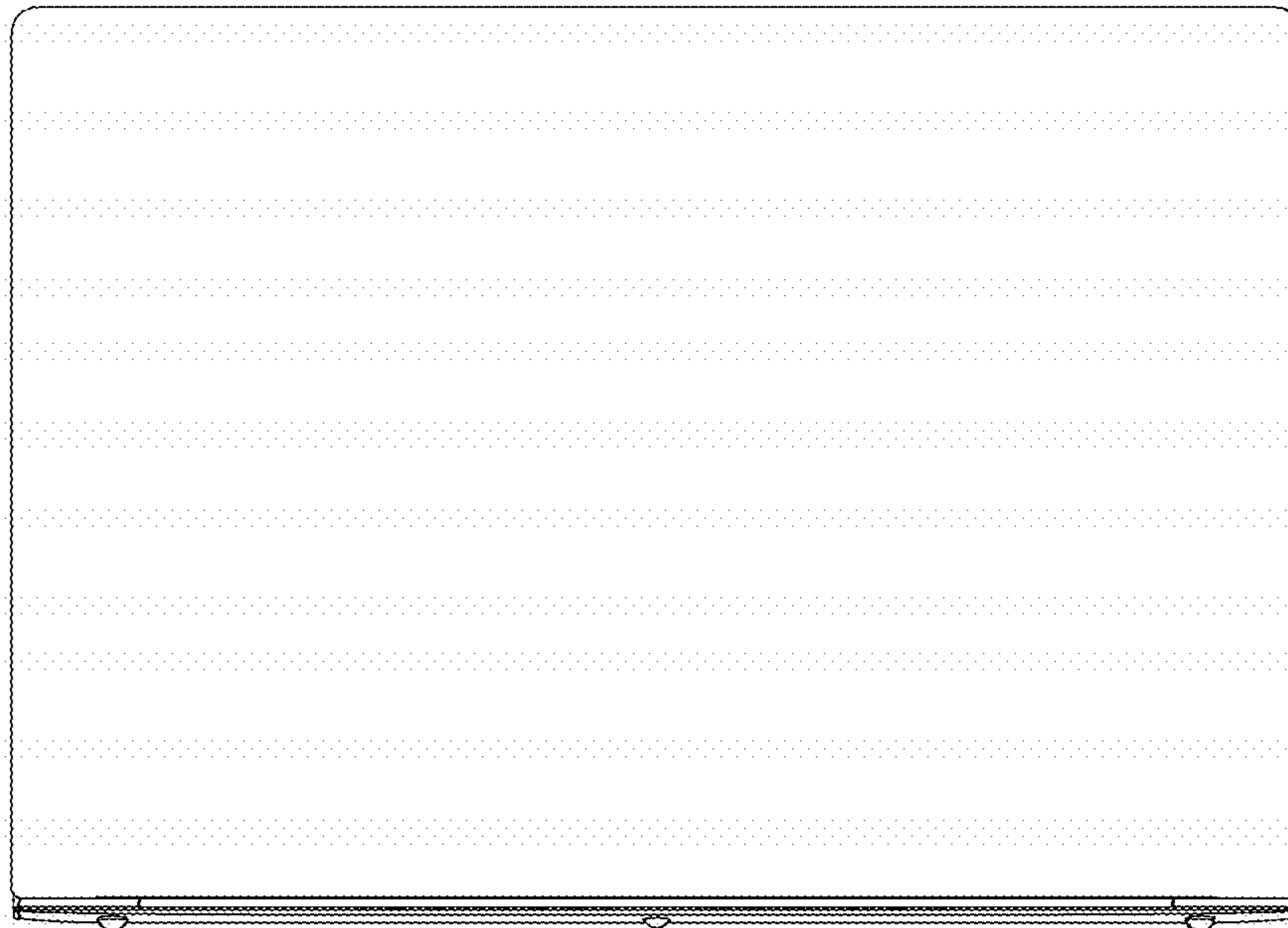

1.11

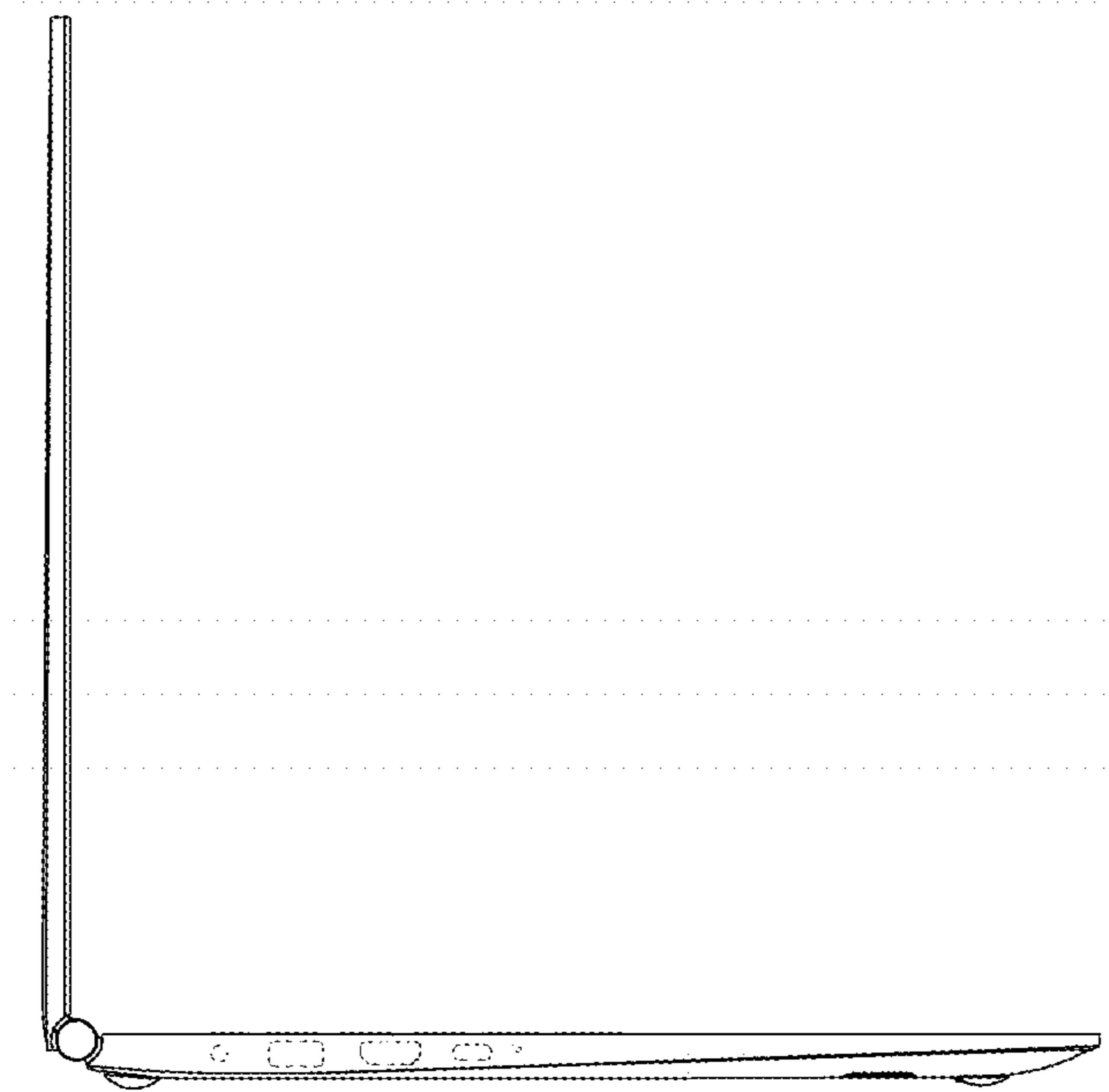

1.12

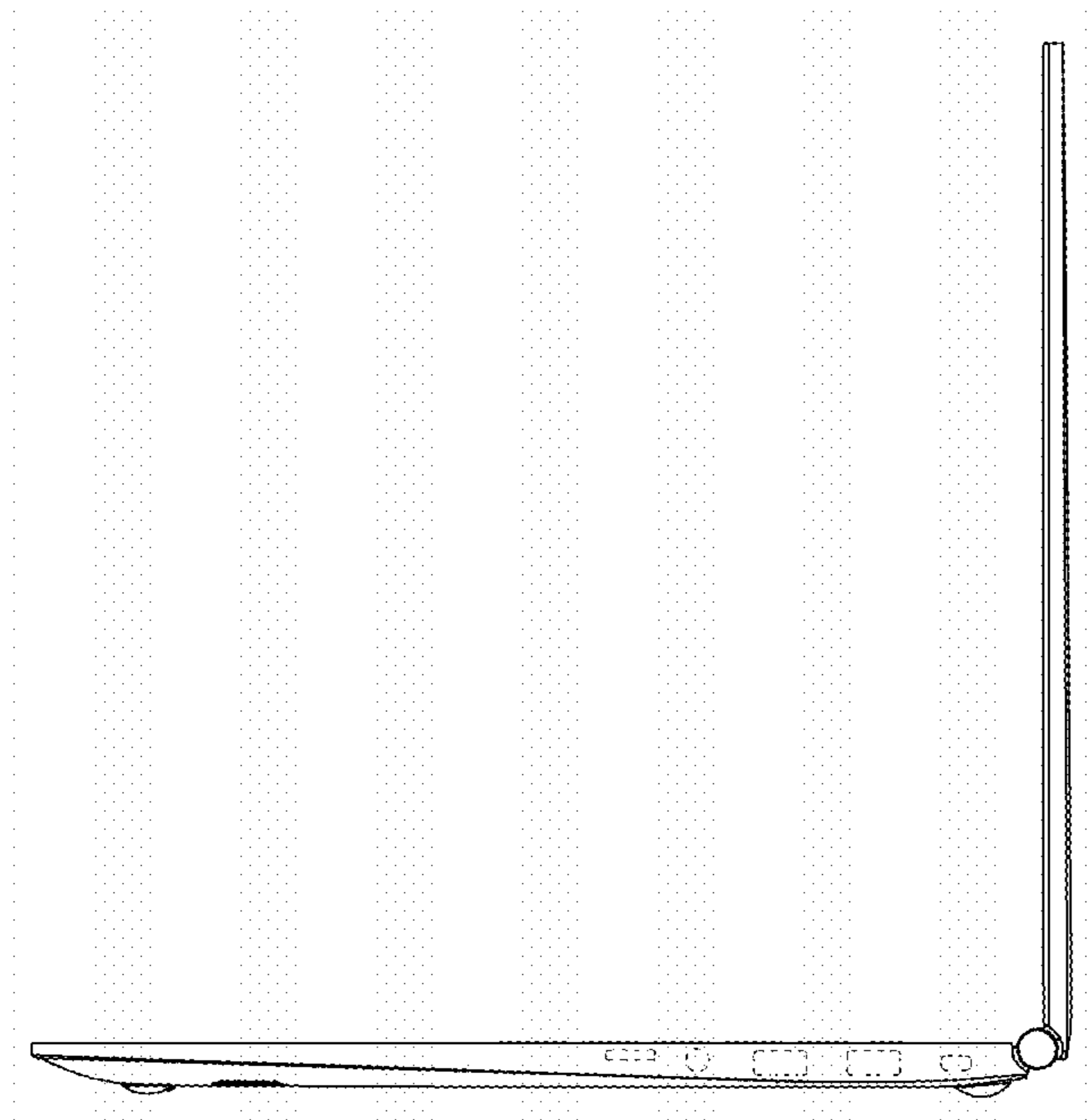

1.13

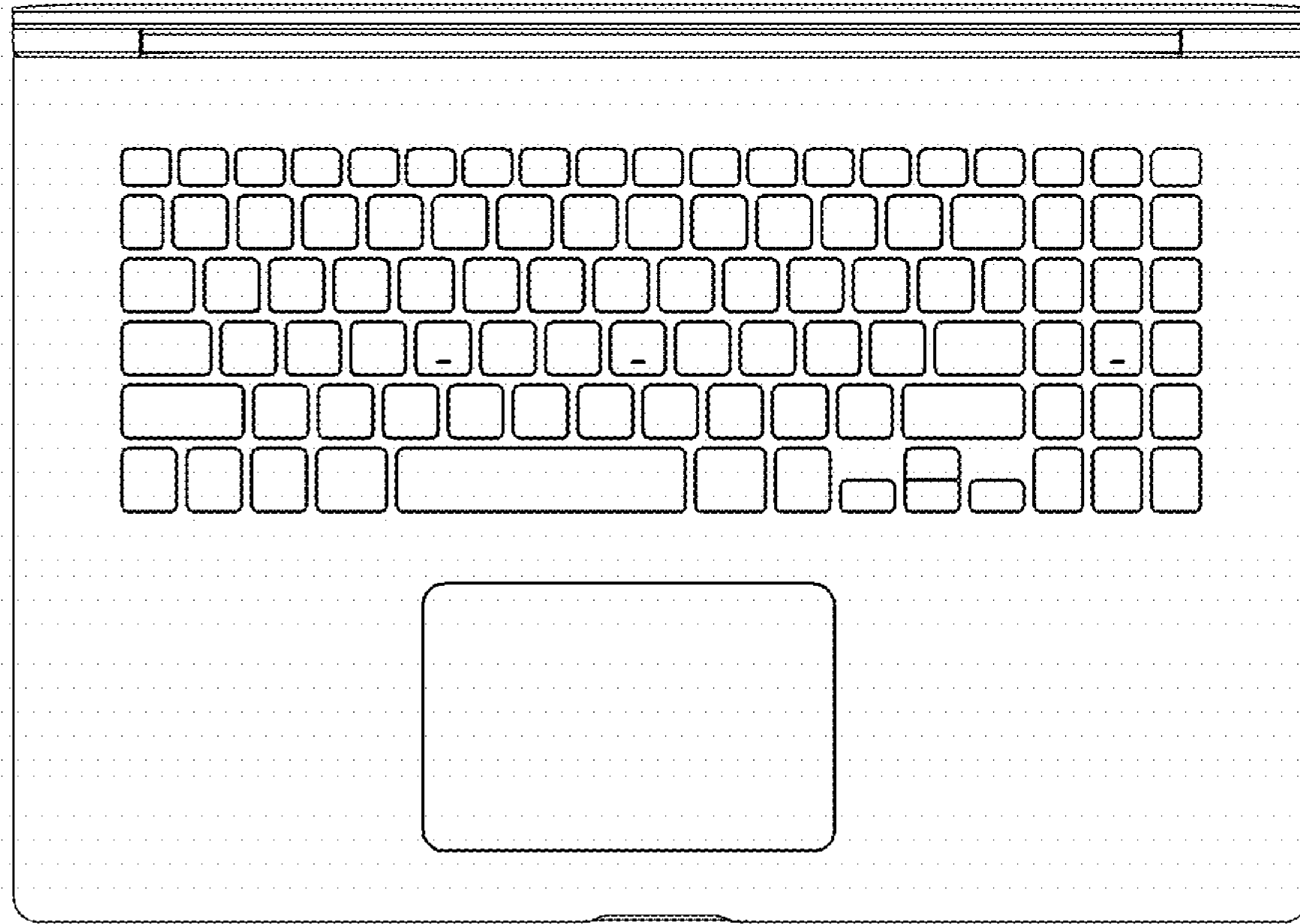

1.14

