



US00D910582S

(12) **United States Design Patent**  
**Migliorino et al.**

(10) **Patent No.:** **US D910,582 S**

(45) **Date of Patent:** **\*\* Feb. 16, 2021**

(54) **HEAT SINK**

(71) Applicant: **Veea Inc.**, Iselin, NJ (US)

(72) Inventors: **Bob Migliorino**, Iselin, NJ (US);  
**Michael Liccone**, Iselin, NJ (US);  
**Shaun Greaney**, Iselin, NJ (US); **Dave Doyle**, Iselin, NJ (US); **Michael Mirabella**, Iselin, NJ (US); **Perry Wintner**, Iselin, NJ (US); **Theodore Lubbe**, Iselin, NJ (US)

(73) Assignee: **VEEA INC.**, New York, NY (US)

(\*\*) Term: **15 Years**

(21) Appl. No.: **29/722,411**

(22) Filed: **Jan. 29, 2020**

(51) **LOC (13) Cl.** ..... **13-03**

(52) **U.S. Cl.**  
USPC ..... **D13/179**

(58) **Field of Classification Search**  
USPC ..... D14/238; D13/179, 122, 182; D8/349,  
D8/354

CPC ..... H01L 2924/00; H01L 23/367; H01L  
23/3672; H01L 23/3677

See application file for complete search history.

(56) **References Cited**

U.S. PATENT DOCUMENTS

D442,565 S *	5/2001	Chou	.....	D13/179
D442,566 S *	5/2001	Chou	.....	D13/179
D464,939 S *	10/2002	Chuang	.....	D13/179
7,430,122 B2 *	9/2008	Li	.....	H01L 23/4093 165/104.33
D593,512 S *	6/2009	Lin	.....	D13/179
7,567,438 B1 *	7/2009	Barsun	.....	H01L 23/4006 361/709

(Continued)

*Primary Examiner* — Keli L Hill

*Assistant Examiner* — Harold E Blackwell, II

(74) *Attorney, Agent, or Firm* — The Marbury Law Group, PLLC

(57) **CLAIM**

The ornamental design for a heat sink, as shown and described.

**DESCRIPTION**

FIG. 1 is a top/left side perspective view of the heat sink supporting antennas.

FIG. 2 is a bottom/right side perspective view of the heat sink supporting antennas.

FIG. 3 is a front view of the heat sink supporting antennas.

FIG. 4 is a rear view of the heat sink supporting antennas.

FIG. 5 is a right side view of the heat sink supporting antennas.

FIG. 6 is a left side view of the heat sink supporting antennas.

FIG. 7 is a top view of the heat sink supporting antennas.

FIG. 8 is a bottom view of the heat sink supporting antennas.

FIG. 9 is a top/left side perspective view of the heat sink without antennas.

FIG. 10 is a bottom/right side perspective view of the heat sink without antennas.

FIG. 11 is a front view of the heat sink without antennas.

FIG. 12 is a rear view of the heat sink without antennas.

FIG. 13 is a right side view of the heat sink without antennas.

FIG. 14 is a left side view of the heat sink without antennas.

FIG. 15 is a top view of the heat sink without antennas; and,

FIG. 16 is a bottom view of the heat sink without antennas.

The broken lines shown in FIGS. 1-16 represent portions of the heat sink design that form no part of the claim.

**1 Claim, 16 Drawing Sheets**

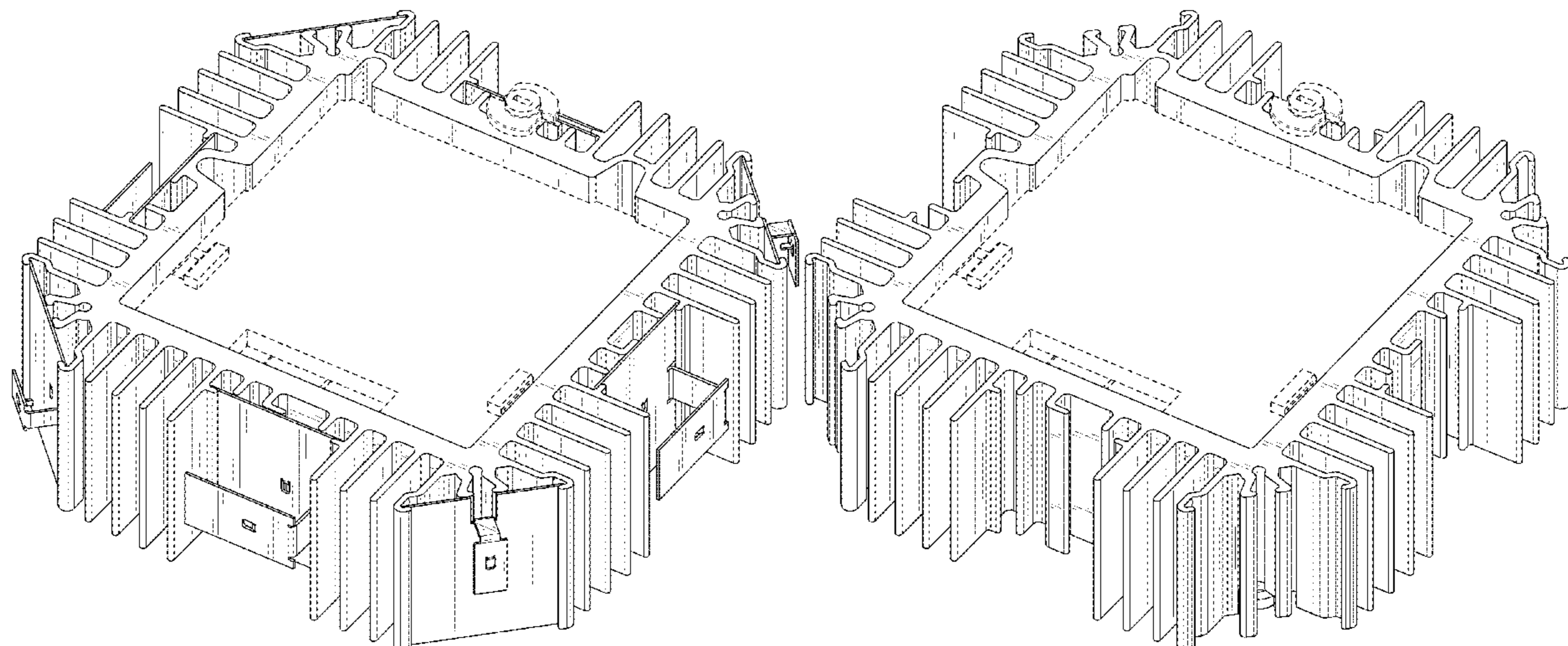

(56)

**References Cited**

U.S. PATENT DOCUMENTS

7,576,989 B2 \* 8/2009 Li ..... H01L 23/4093  
165/185  
D603,810 S \* 11/2009 Yang ..... D13/179  
8,348,570 B2 \* 1/2013 Ye ..... H01L 23/4006  
411/383  
D706,973 S \* 6/2014 Shih ..... D26/113  
9,543,226 B1 \* 1/2017 Nuttall ..... H01L 23/373  
D786,202 S \* 5/2017 Hodrinsky ..... D13/179  
2005/0088823 A1 \* 4/2005 Kabadi ..... C04B 38/0067  
361/704  
2009/0067133 A1 \* 3/2009 Li ..... H01L 23/34  
361/709  
2014/0345844 A1 \* 11/2014 Chou ..... H01L 23/467  
165/185

\* cited by examiner

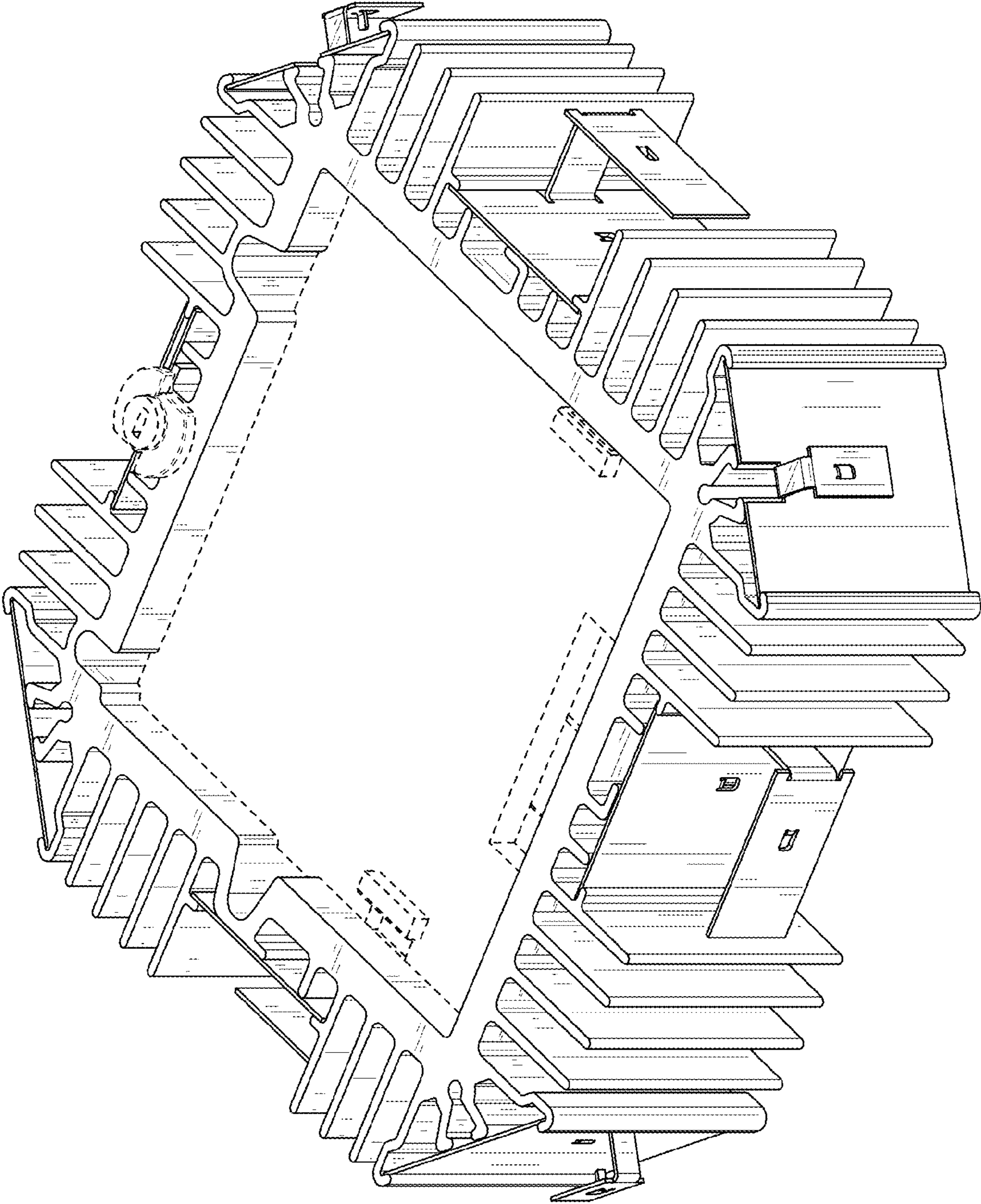

FIG. 1

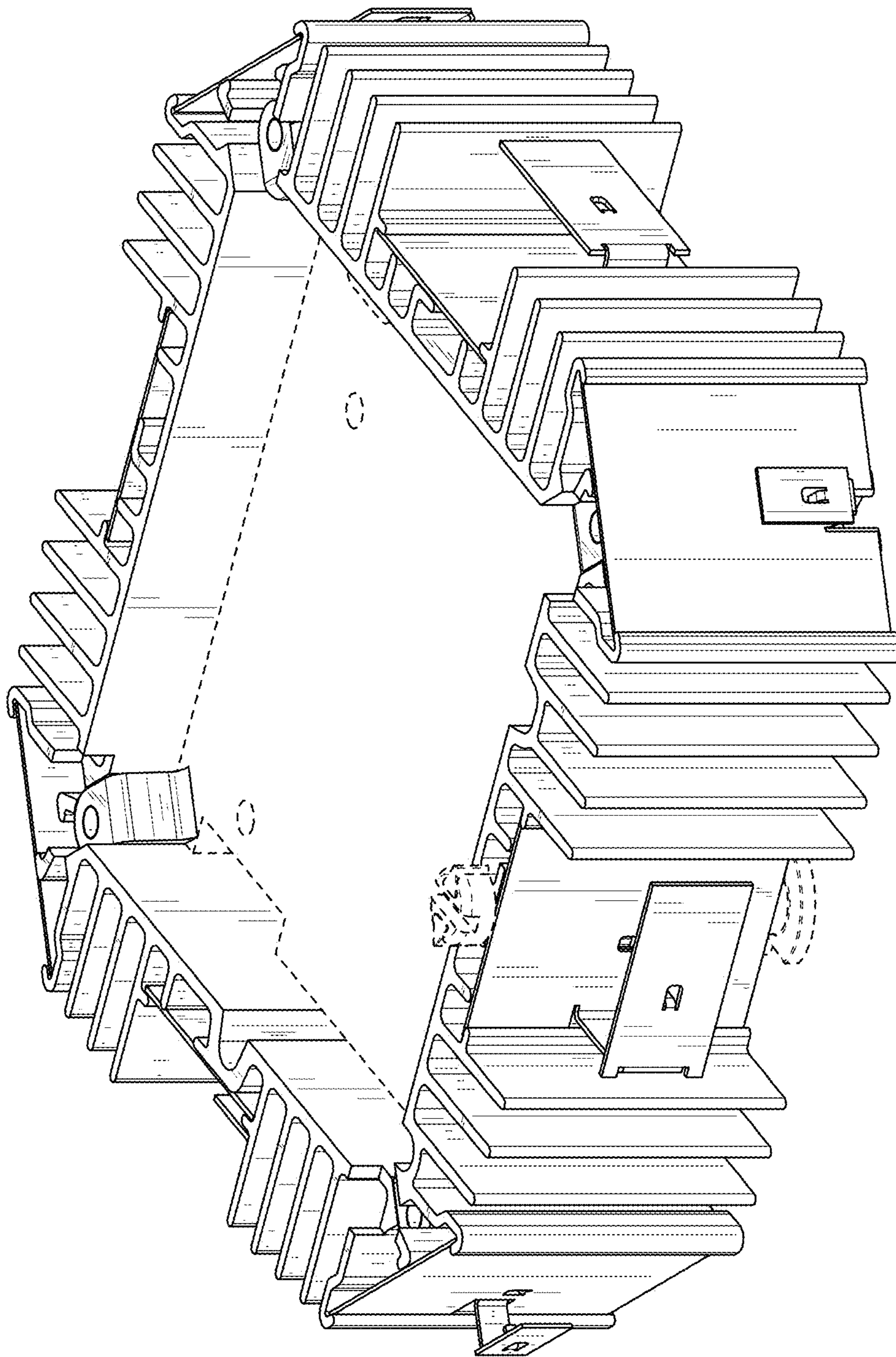

FIG. 2

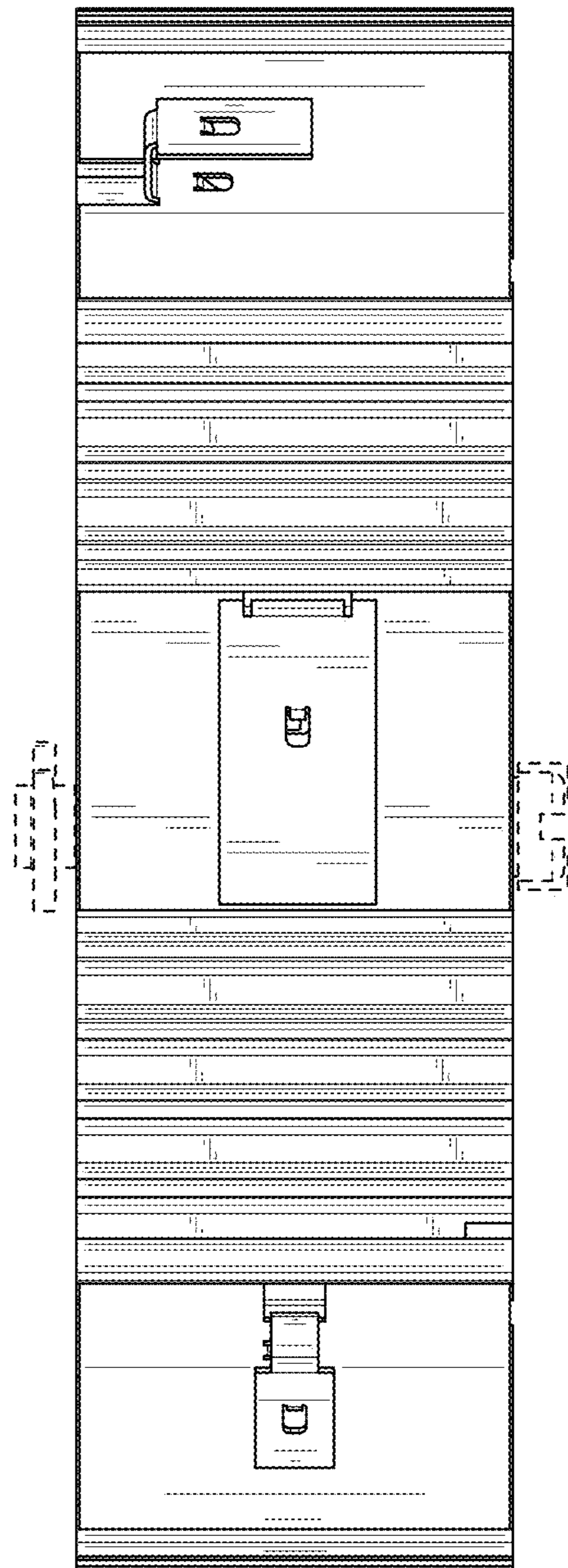

FIG. 3

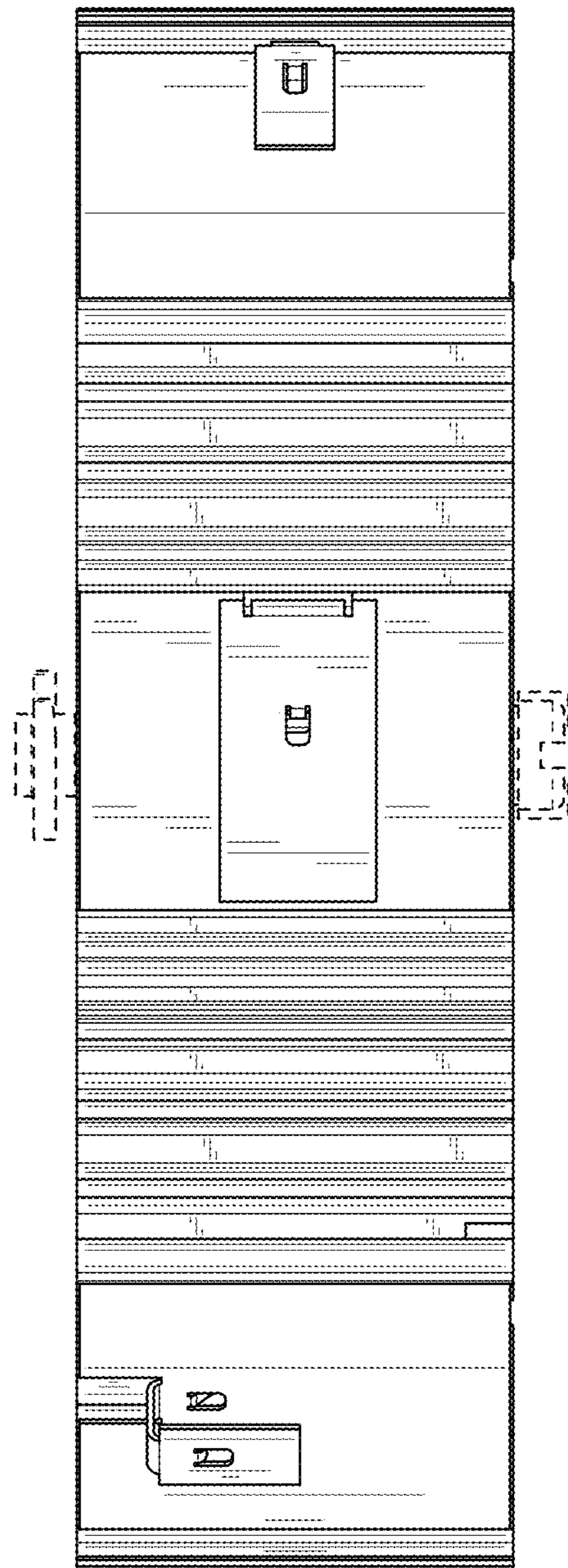

FIG. 4

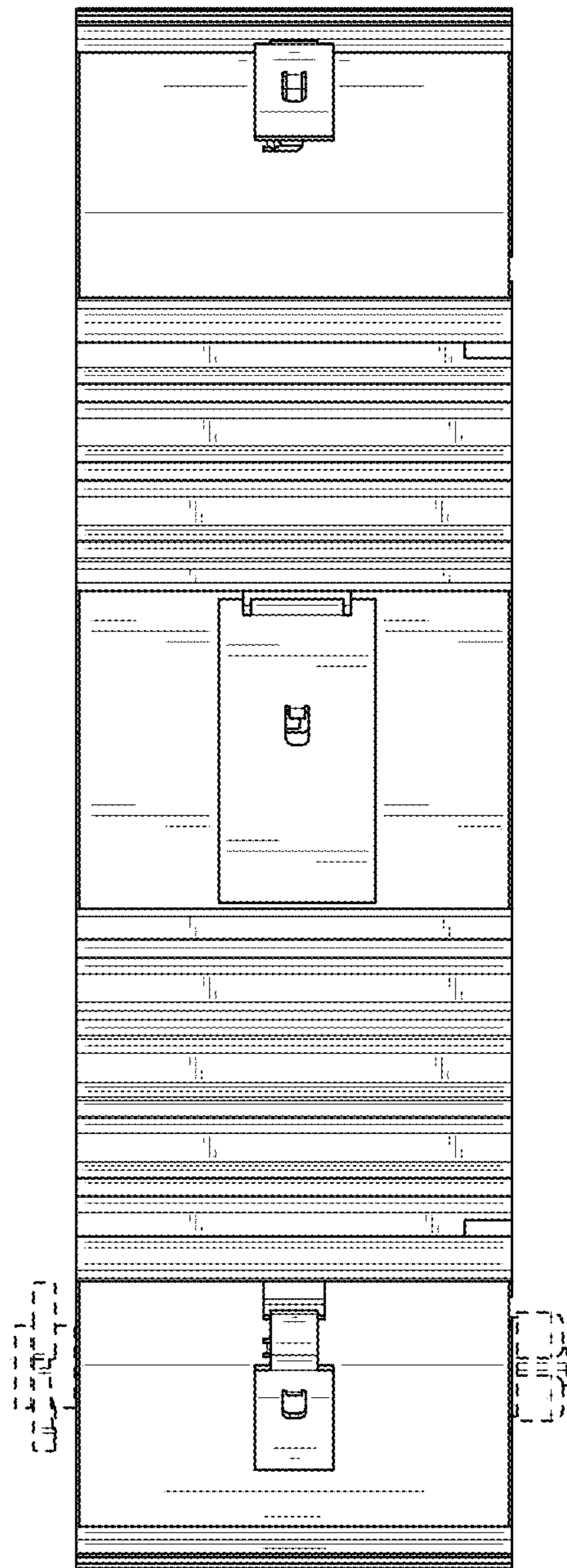

FIG. 5

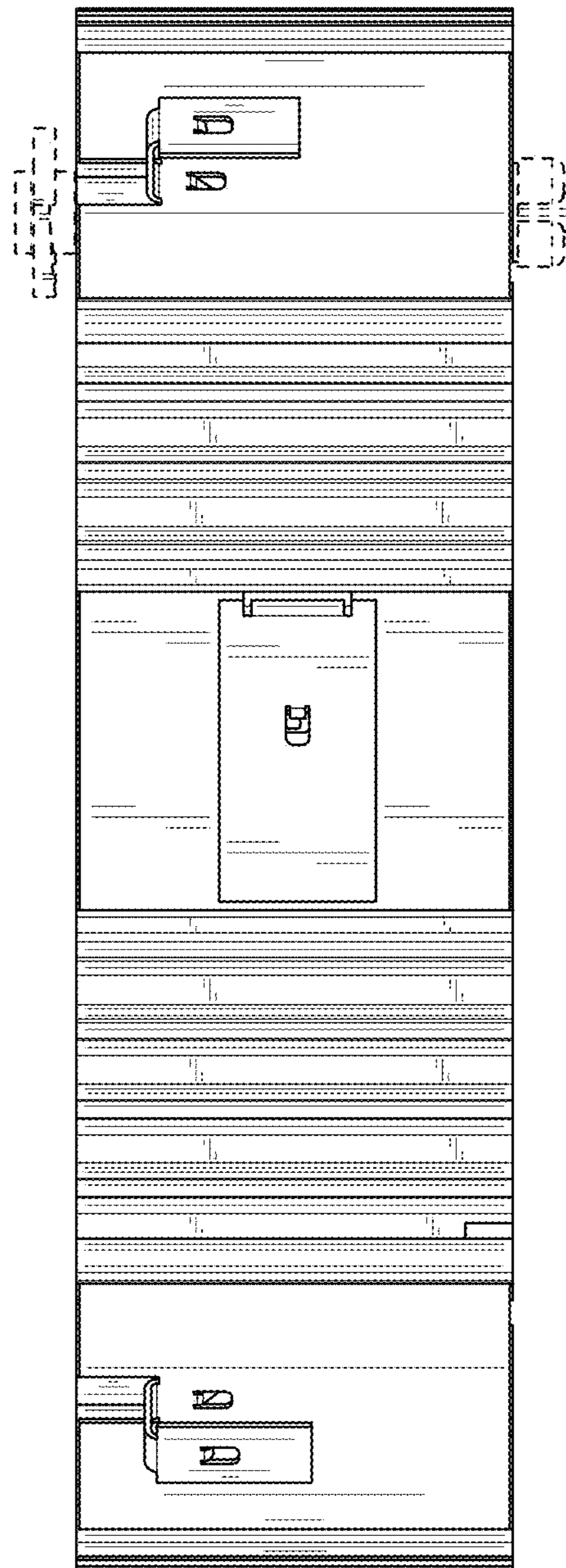

FIG. 6



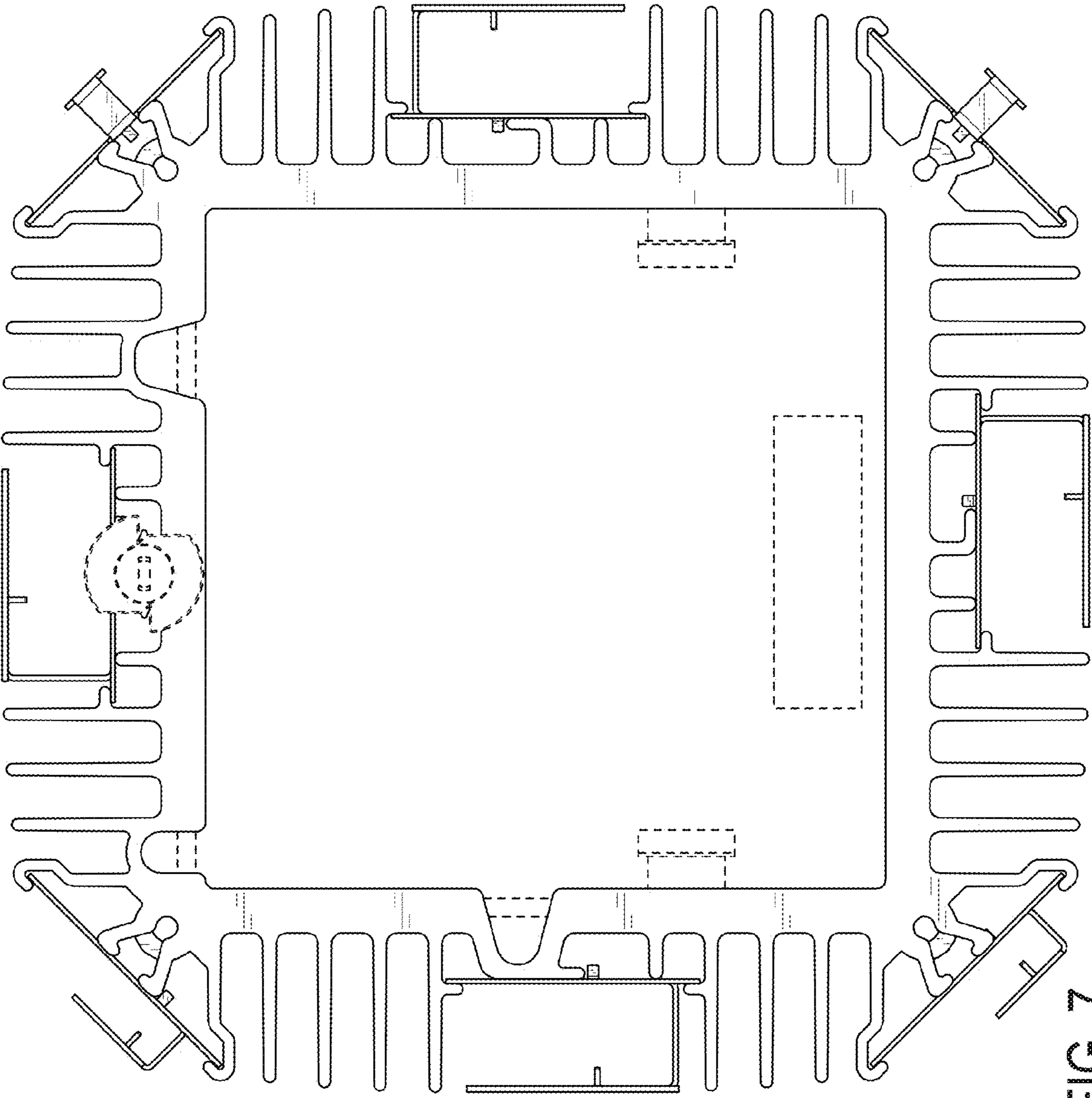

FIG. 7

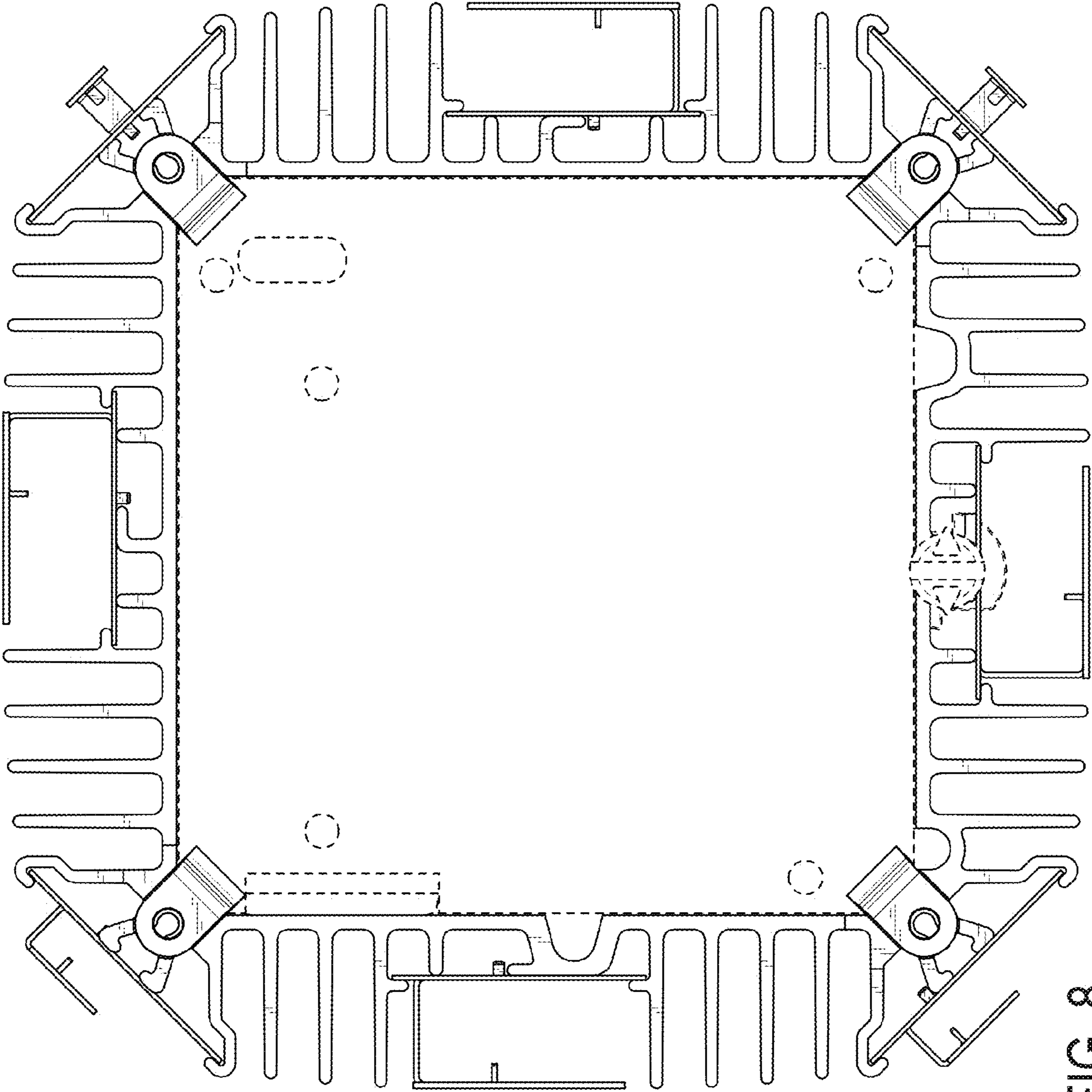

FIG. 8

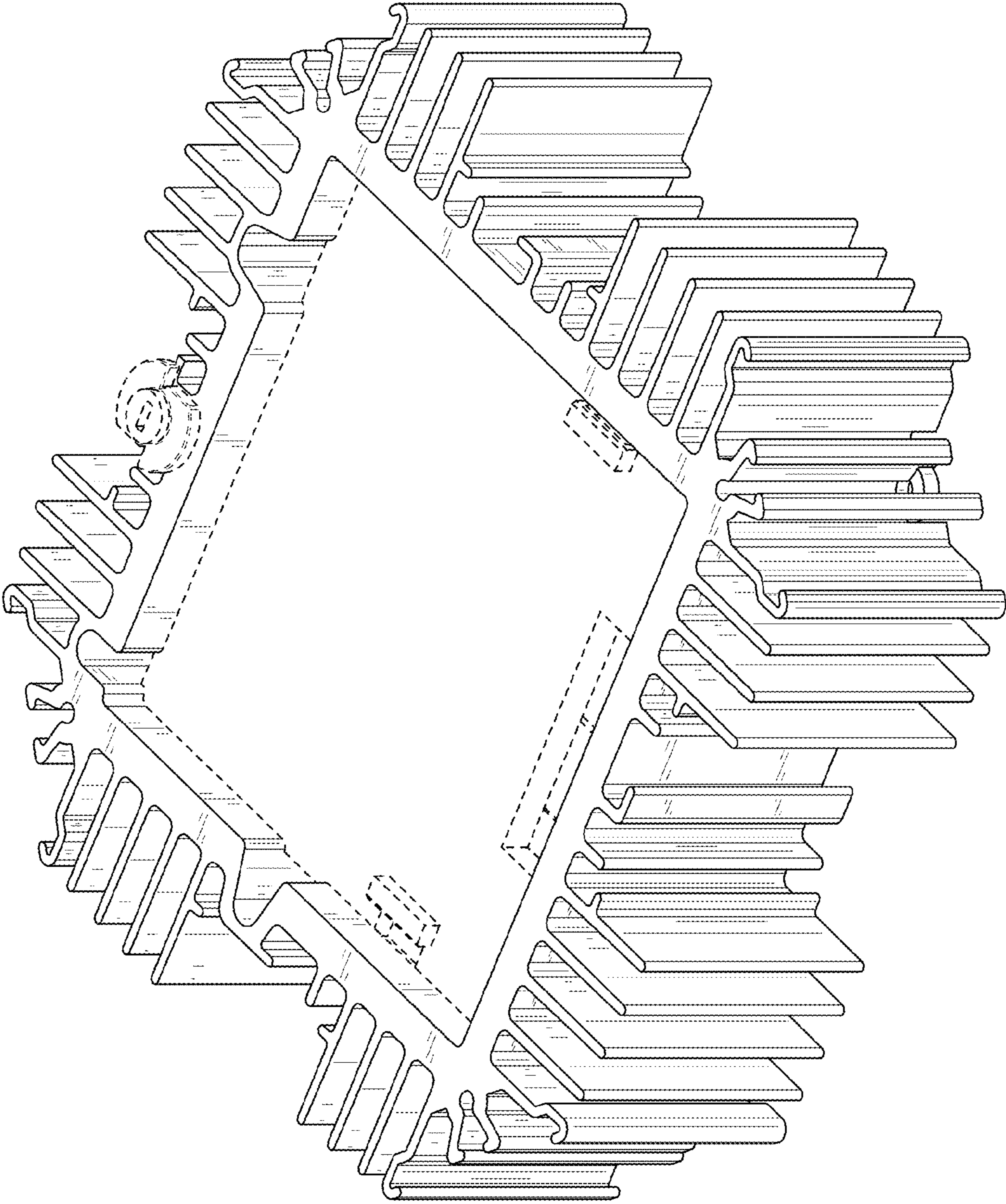

FIG. 9

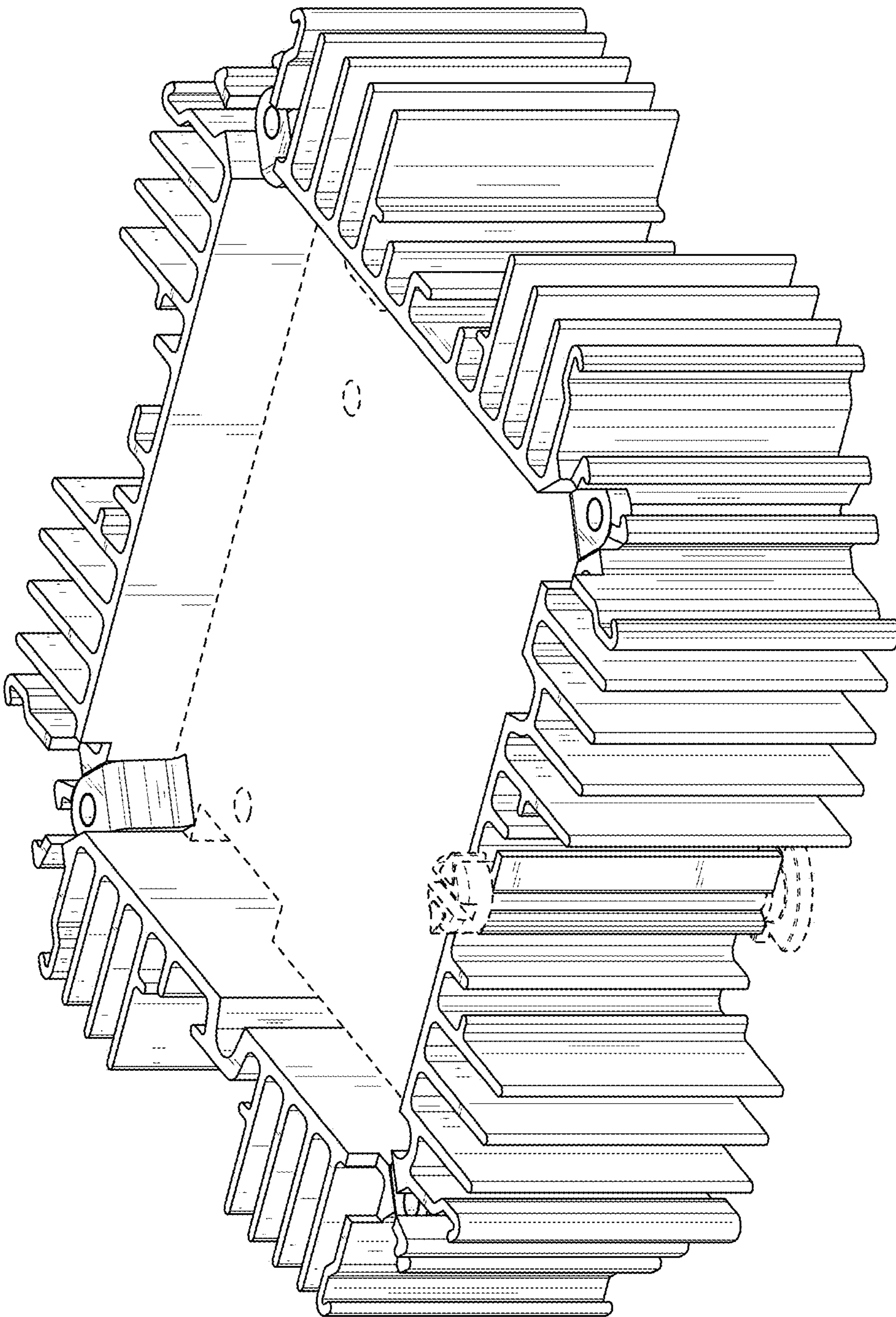

FIG. 10

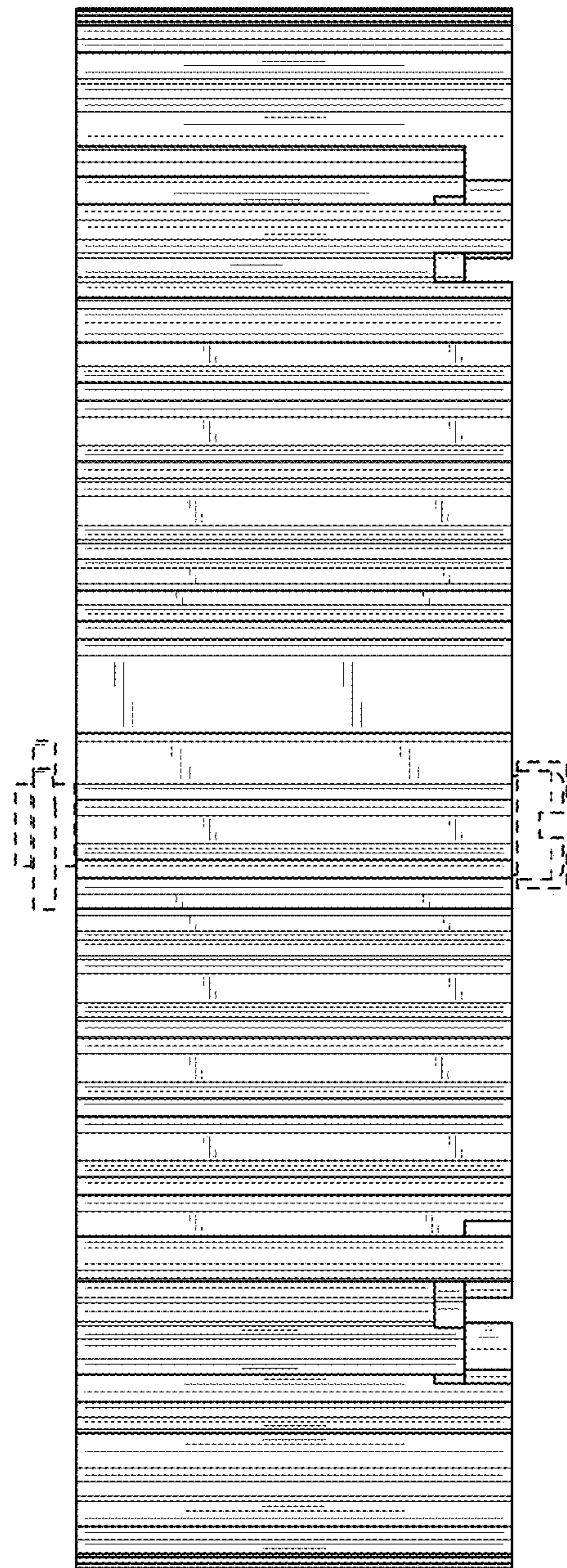

FIG. 11

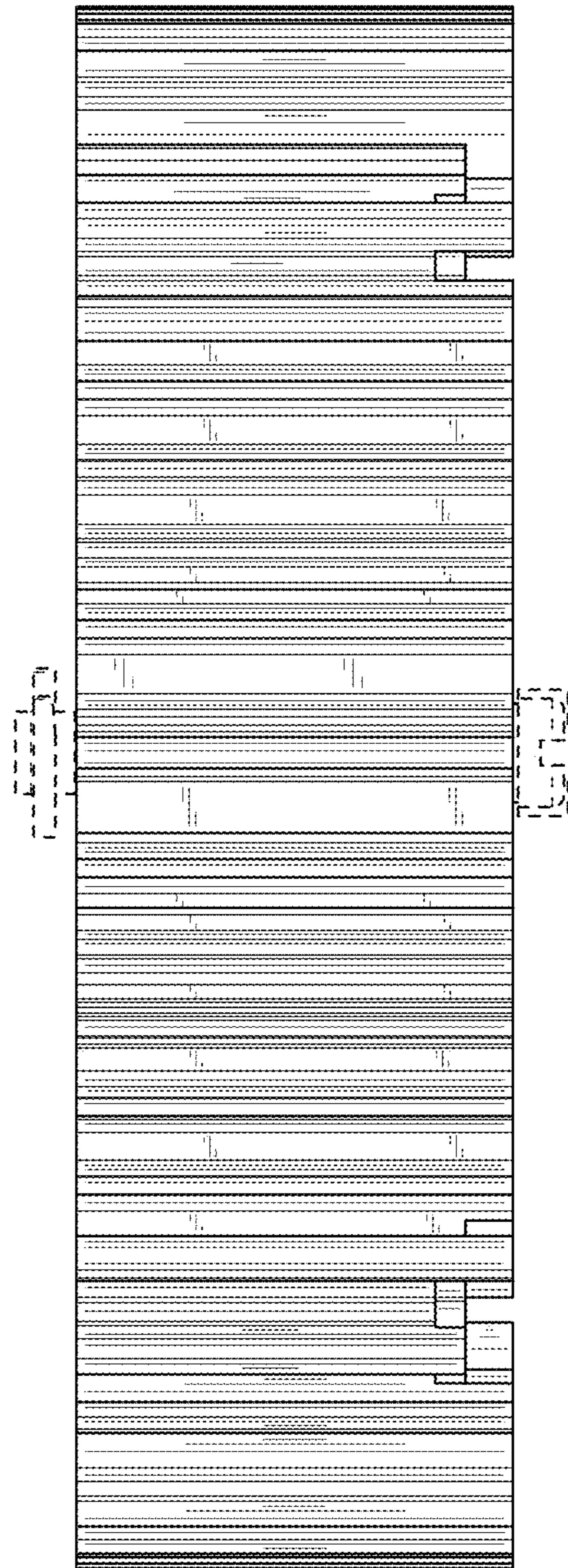

FIG. 12

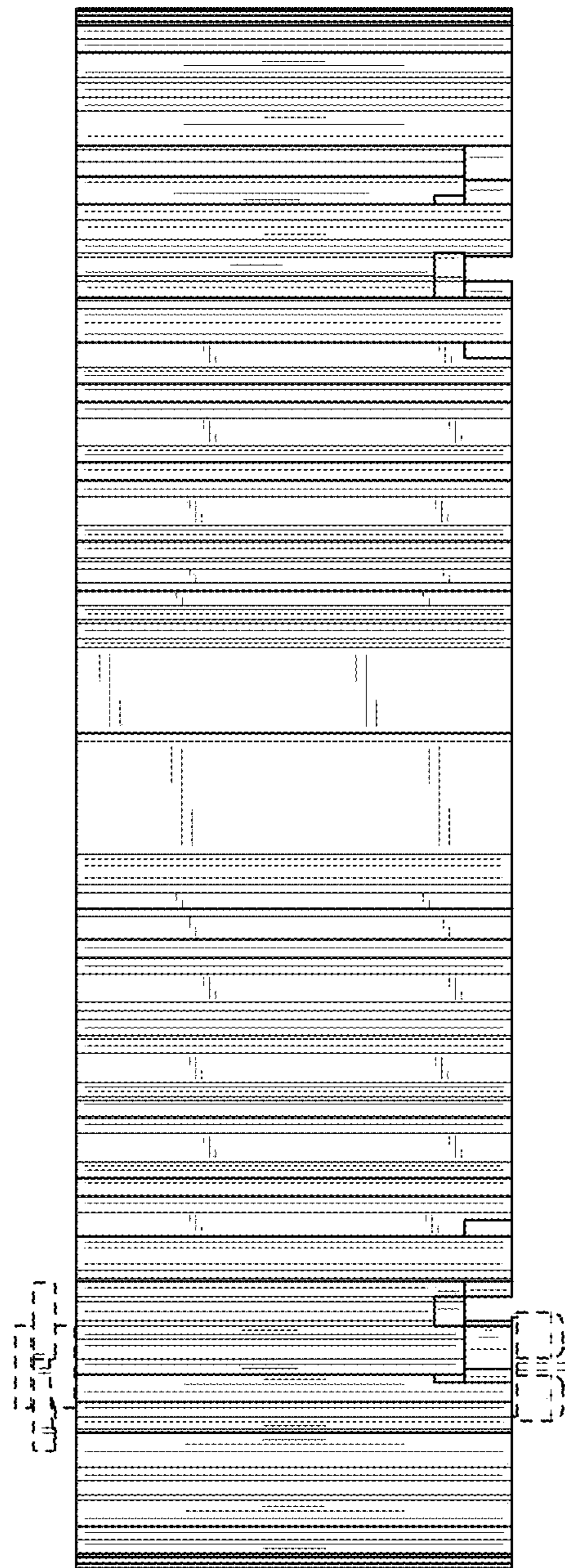

FIG. 13

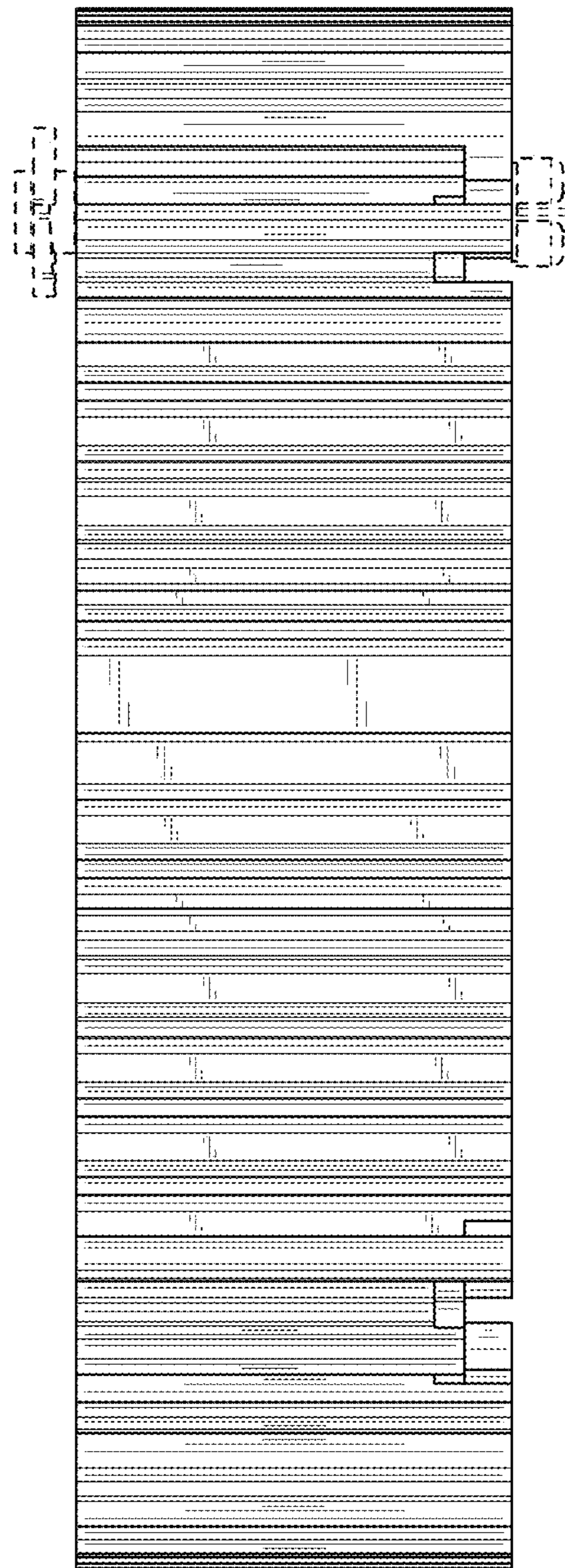

FIG. 14



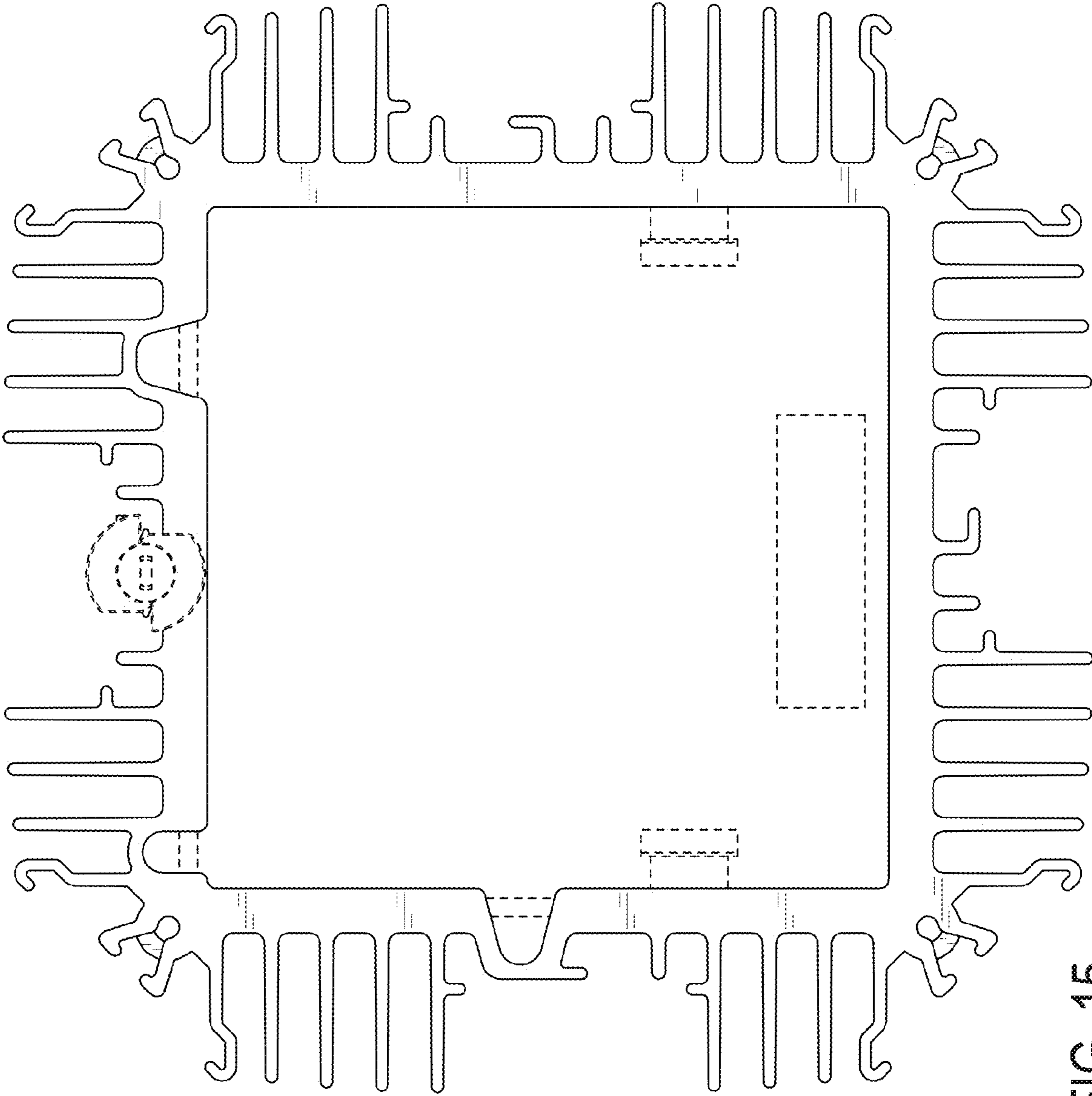

FIG. 15

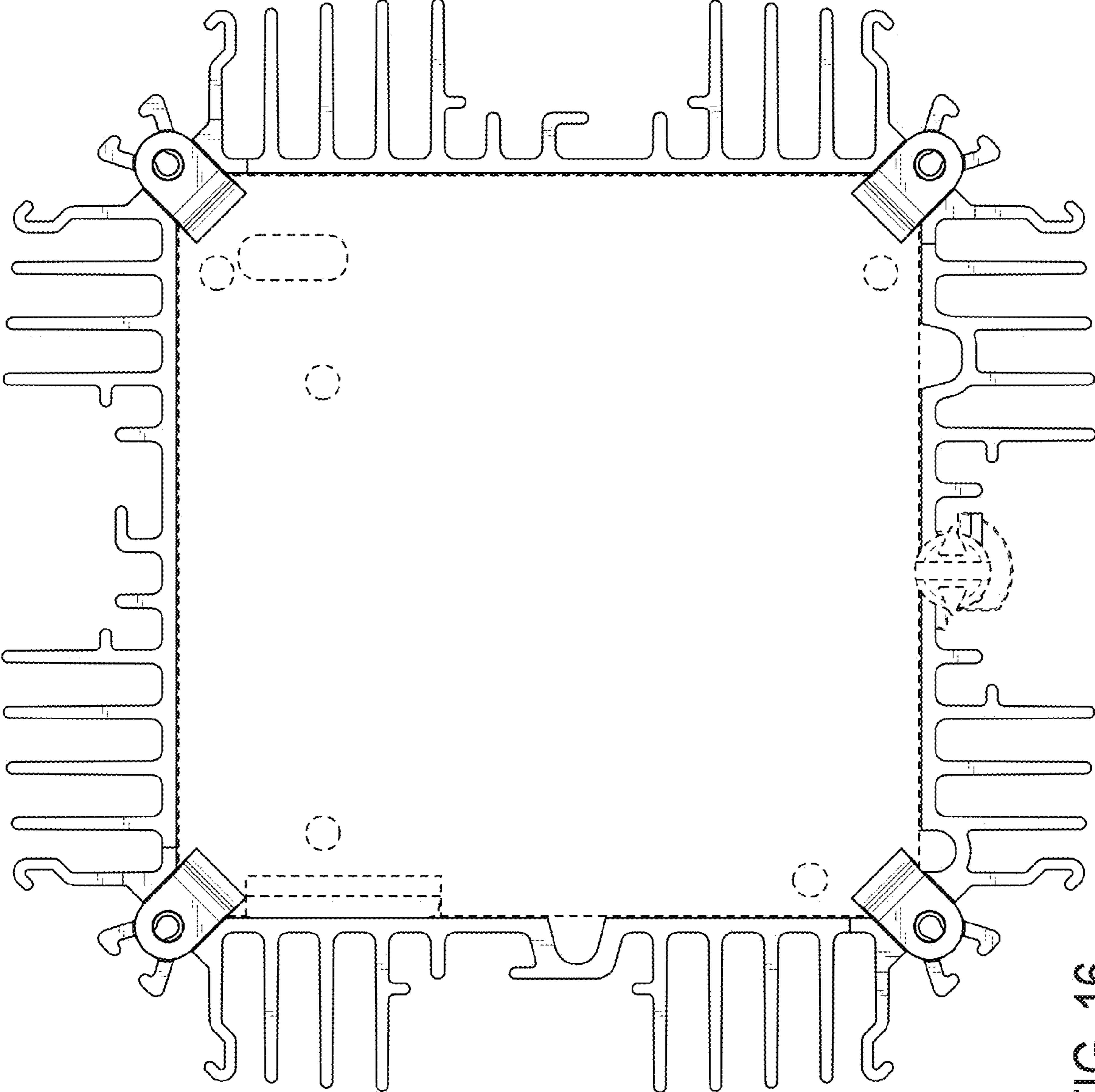

FIG. 16