



US00D910574S

(12) **United States Design Patent**
Hartmann

(10) **Patent No.:** **US D910,574 S**

(45) **Date of Patent:** **** Feb. 16, 2021**

(54) **ELECTRIC TERMINAL**

(71) Applicant: **WAGO Verwaltungsgesellschaft mbH**,
Minden (DE)

(72) Inventor: **Frank Hartmann**, Minden (DE)

(73) Assignee: **WAGO Verwaltungsgesellschaft mbH**,
Minden (DE)

(**) Term: **15 Years**

(21) Appl. No.: **29/667,338**

(22) Filed: **Oct. 19, 2018**

(30) **Foreign Application Priority Data**

Apr. 19, 2018 (EM) 005240314-0001

Apr. 19, 2018 (EM) 005240728-0001

(51) **LOC (13) Cl.** **13-03**

(52) **U.S. Cl.**
USPC **D13/146**

(58) **Field of Classification Search**

USPC D13/118, 120, 123, 133, 146, 147, 154,
D13/184, 199; D14/240, 242, 432-435,
D14/435.1, 436-438; D9/456

CPC H01R 4/48; H01R 4/4836; H01R 4/4845;
H01R 9/24; H01R 13/02; H01R 13/2407;
H01R 13/52; H01R 13/62; H01R 13/629;

(Continued)

(56) **References Cited**

U.S. PATENT DOCUMENTS

D552,688 S * 10/2007 Hussaini D14/434

D669,478 S * 10/2012 Lepp D14/436

D669,479 S * 10/2012 Lepp D14/436

(Continued)

OTHER PUBLICATIONS

WAGO. Item No. 2106-1301. No date specified. <https://www.wago.com/global/rail-mount-terminal-blocks/3-conductor-through-terminal-block/p/2106-1301> (Year: 0).*

(Continued)

Primary Examiner — Darcey E Gottschalk

(74) *Attorney, Agent, or Firm* — Muncy, Geissler, Olds & Lowe, P.C.

(57) **CLAIM**

The ornamental design for an electric terminal, as shown and described.

DESCRIPTION

FIG. 1 is a rear view of an electric terminal according to the present invention.

FIG. 2 is a rear perspective view of the electric terminal of FIG. 1.

FIG. 3 is a left side view of the electric terminal of FIG. 1.

FIG. 4 is a top view of the electric terminal of FIG. 1.

FIG. 5 is a right side view of the electric terminal of FIG. 1.

FIG. 6 is a bottom view of the electric terminal of FIG. 1.

FIG. 7 is a front view of the electric terminal of FIG. 1.

FIG. 8 is a rear view of an electric terminal according to the present invention.

FIG. 9 is a rear perspective view of the electric terminal of FIG. 8.

FIG. 10 is a left side view of the electric terminal of FIG. 8.

FIG. 11 is a top view of the electric terminal of FIG. 8.

FIG. 12 is a right side view of the electric terminal of FIG. 8.

FIG. 13 is a bottom view of the electric terminal of FIG. 8; and,

FIG. 14 is a front view of the electric terminal of FIG. 8.

The dashed lines illustrate environment that does not form a part of the present invention, and no claim is made to the material illustrated with dashed lines.

1 Claim, 14 Drawing Sheets

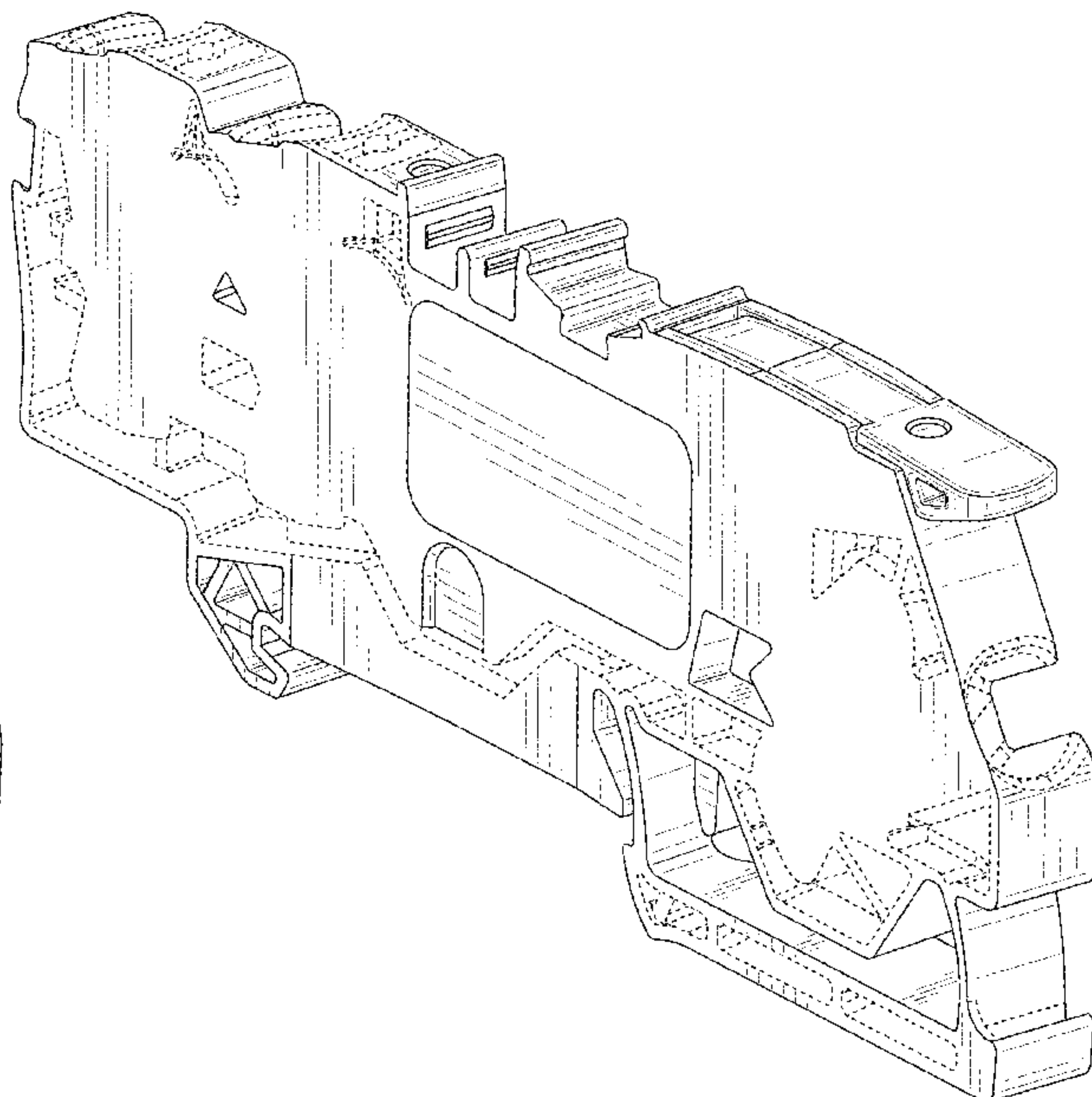
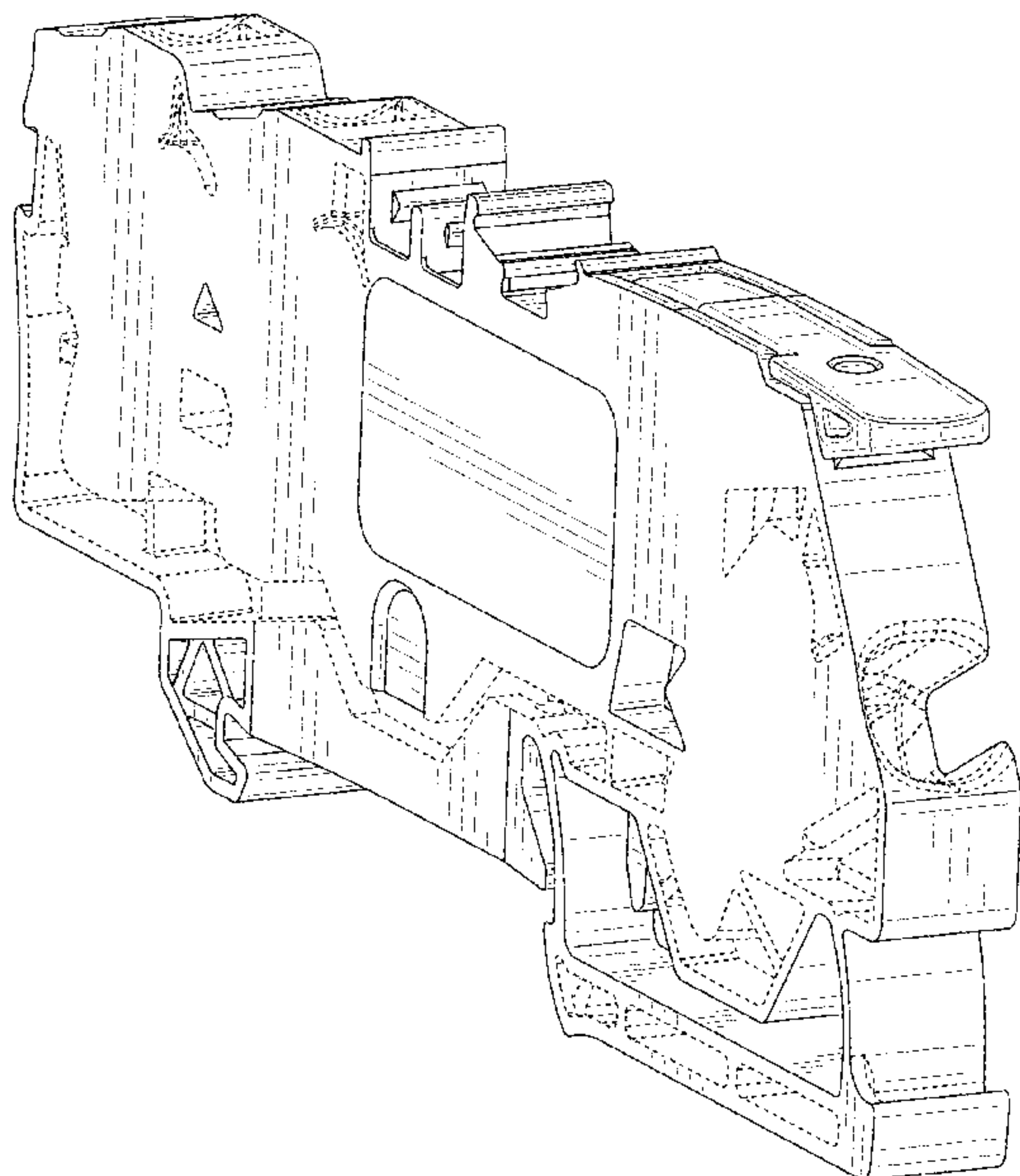

(58) **Field of Classification Search**

CPC H01R 13/633; H01R 13/639; H01R 43/18;
H01R 43/20

See application file for complete search history.

(56) **References Cited**

U.S. PATENT DOCUMENTS

D727,910	S	*	4/2015	Kang	D14/436
D727,911	S	*	4/2015	Kang	D14/436
D727,912	S	*	4/2015	Kang	D14/436
D727,913	S	*	4/2015	Kang	D14/436
D732,038	S	*	6/2015	Schiller	D14/436
D732,535	S	*	6/2015	Binner	D14/432
D824,860	S	*	8/2018	Mastel	D13/147
D824,861	S	*	8/2018	Mastel	D13/147
D825,476	S	*	8/2018	Mastel	D13/147
D825,477	S	*	8/2018	Mastel	D13/147
D825,478	S	*	8/2018	Mastel	D13/147
D825,479	S	*	8/2018	Mastel	D13/147
D825,480	S	*	8/2018	Mastel	D13/147
D825,481	S	*	8/2018	Mastel	D13/147
D825,482	S	*	8/2018	Mastel	D13/147
D825,483	S	*	8/2018	Mastel	D13/147
D826,167	S	*	8/2018	Mastel	D13/147
D826,168	S	*	8/2018	Mastel	D13/147
D826,169	S	*	8/2018	Mastel	D13/147
D826,170	S	*	8/2018	Mastel	D13/147
D867,365	S	*	11/2019	Corigliano	D14/401

OTHER PUBLICATIONS

WAGO. Rail-Mount Terminal Blocks. No date specified. <https://www.wago.com/global/c/rail-mount-terminal-blocks?pageSize=50>
(Year: 0).*

* cited by examiner

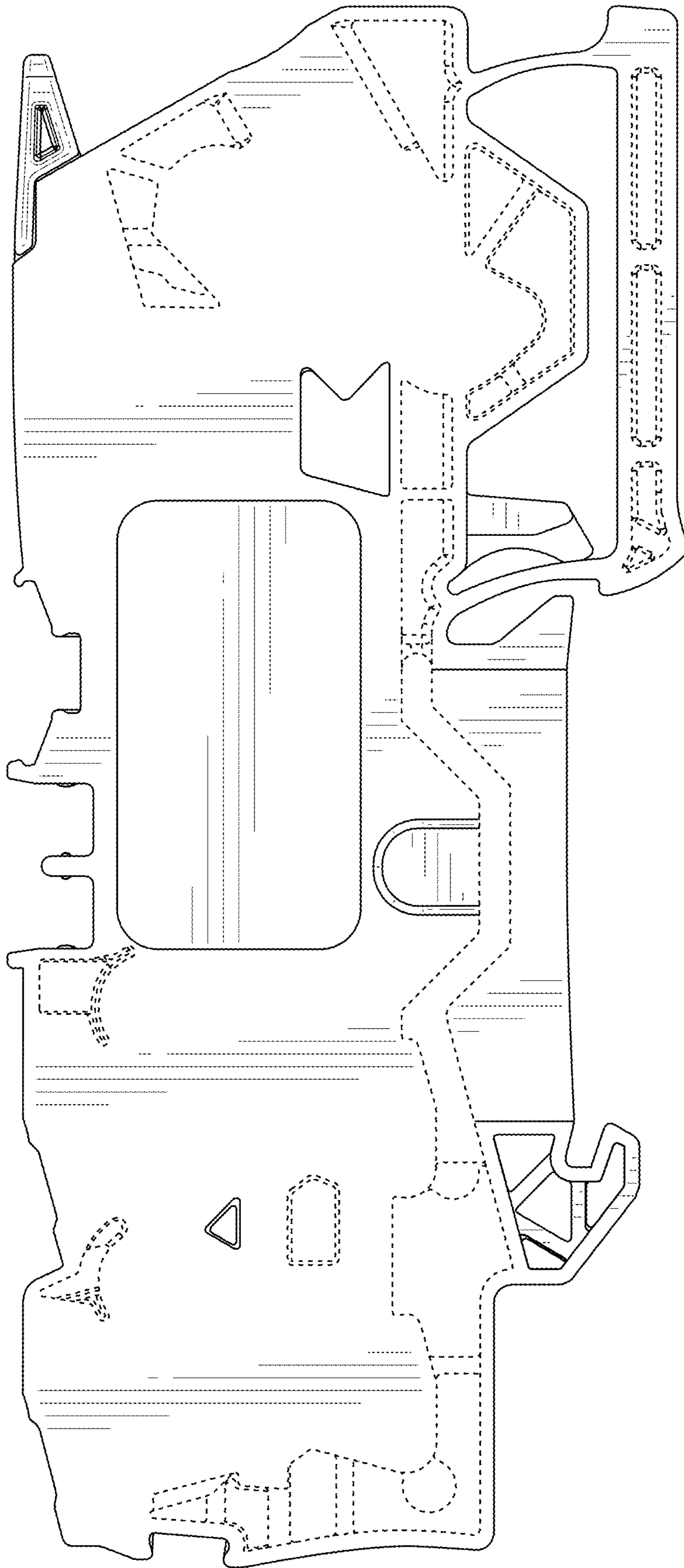

FIG. 1

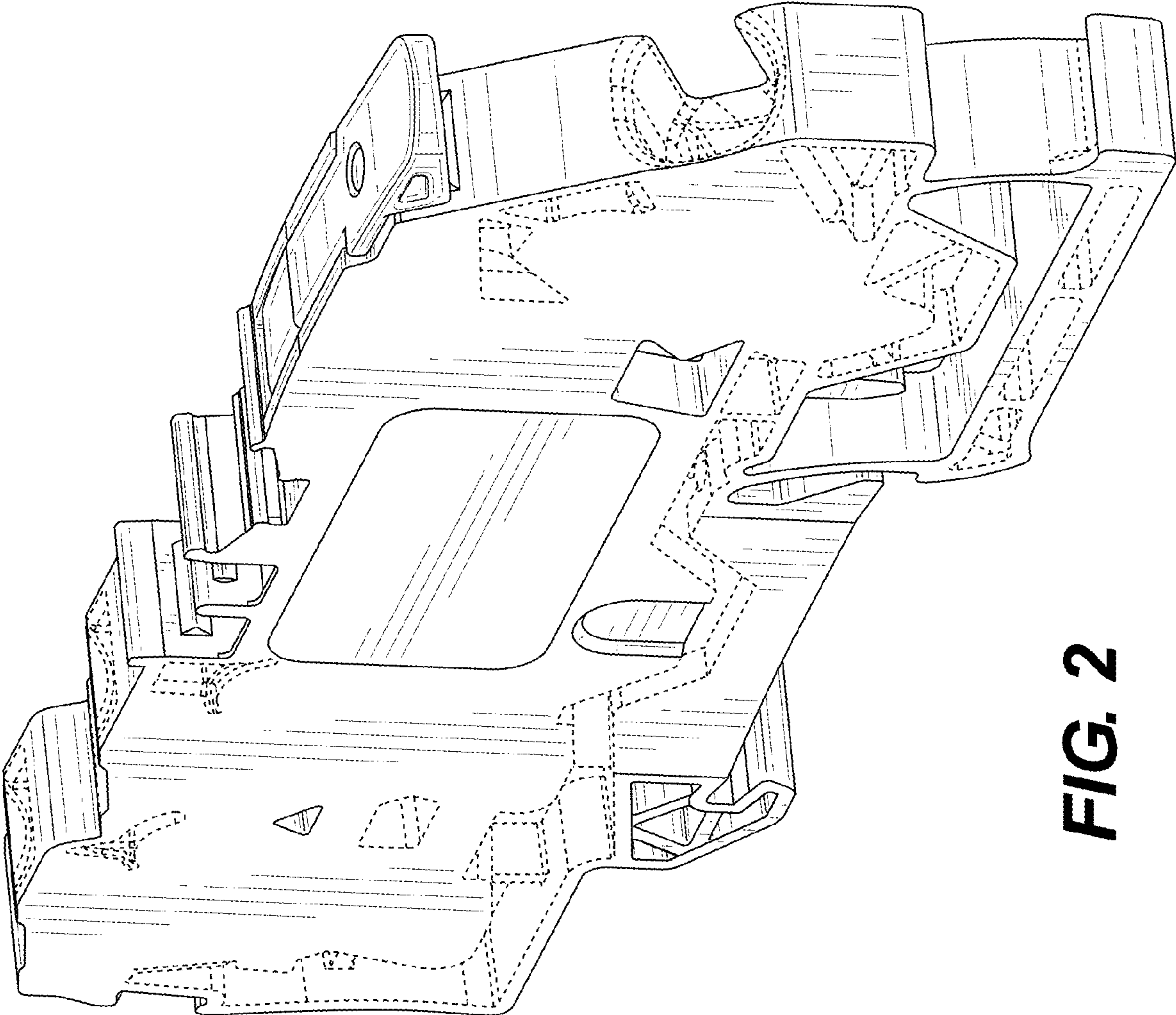

FIG. 2

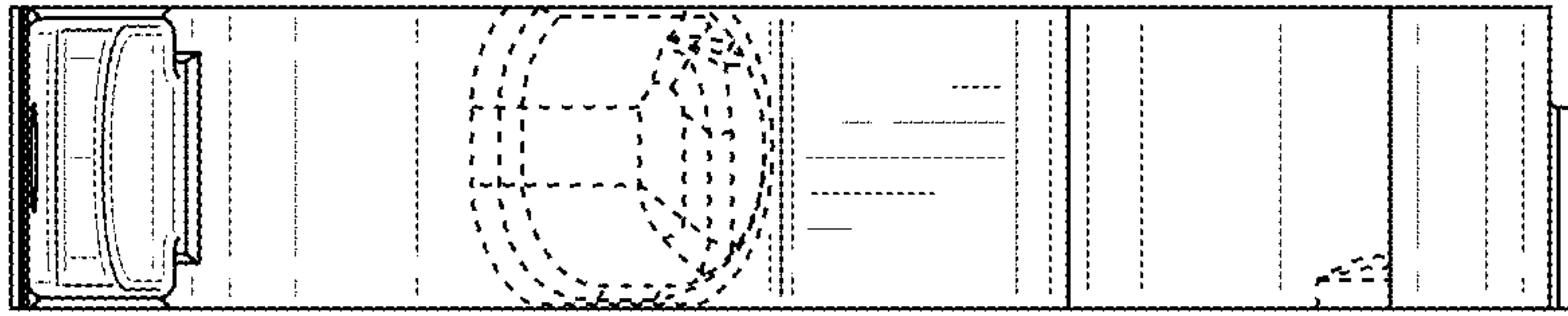

FIG. 3

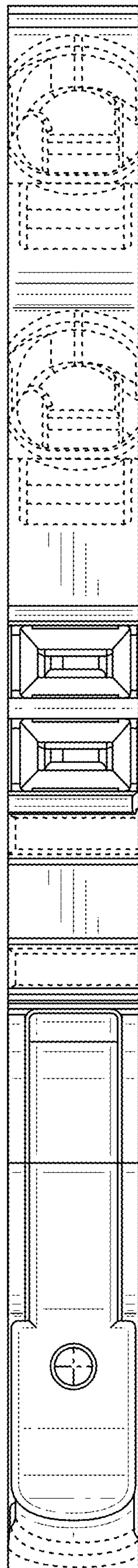

FIG. 4

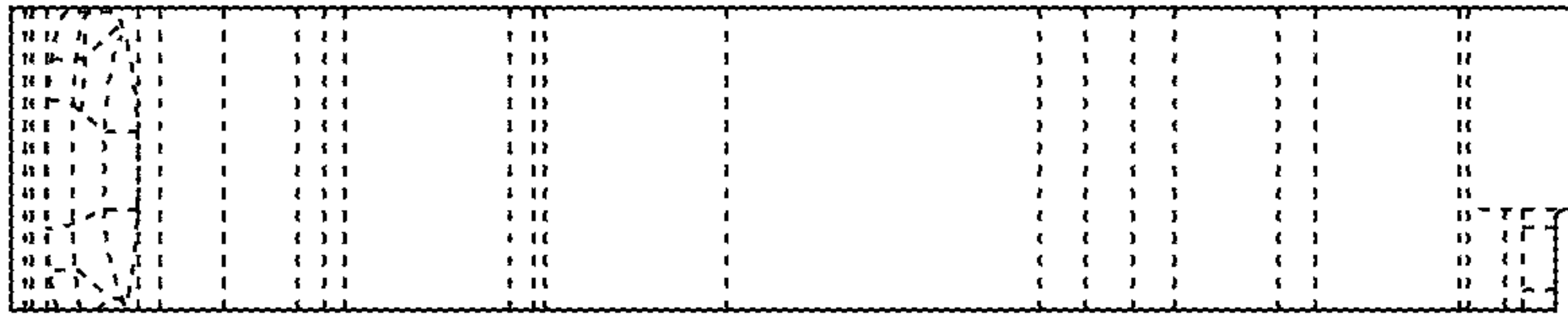

FIG. 5

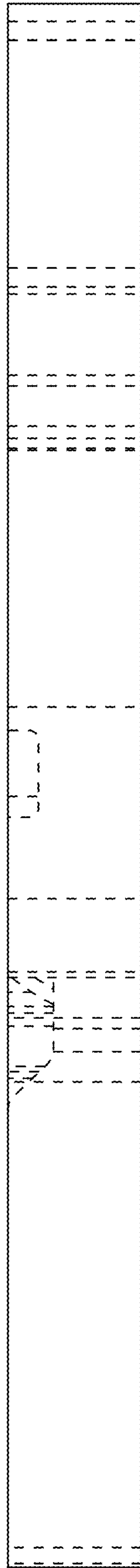

FIG. 6

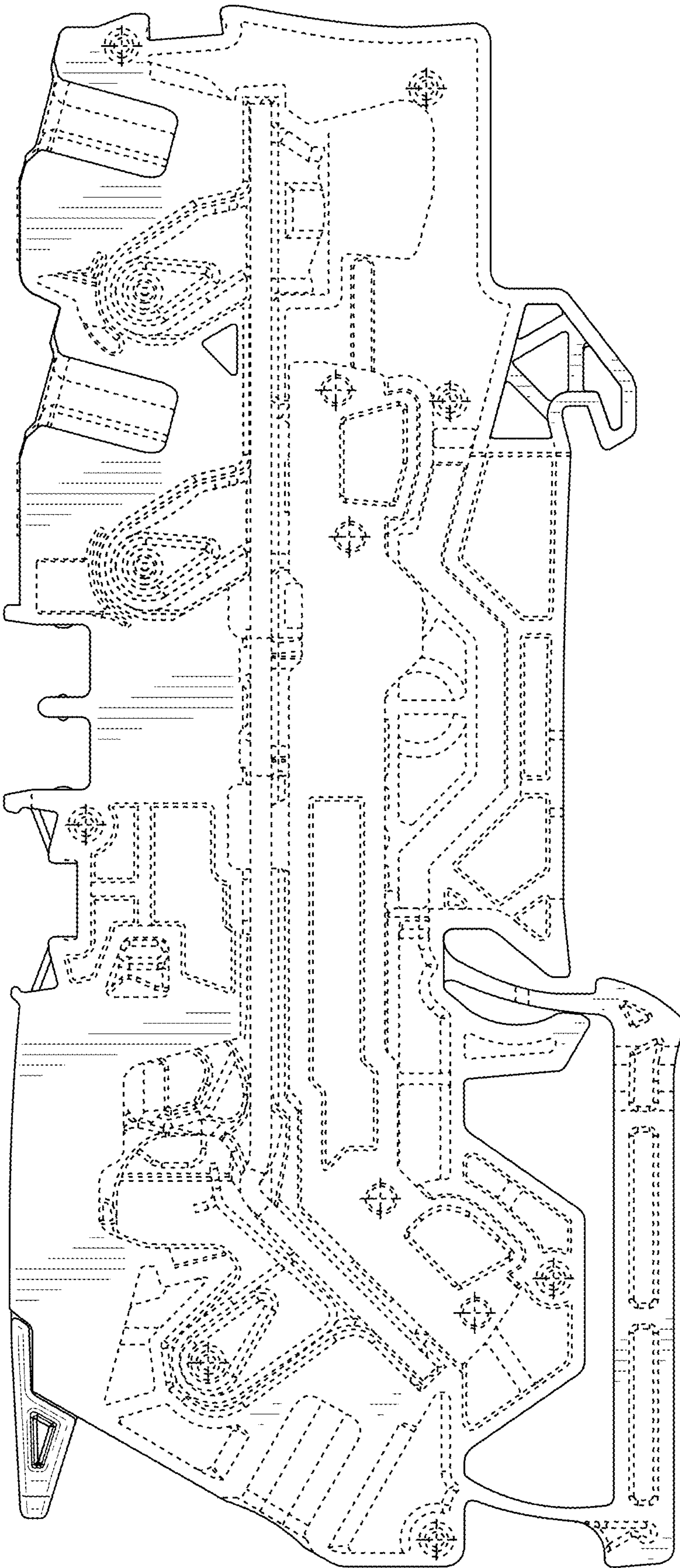

FIG. 7

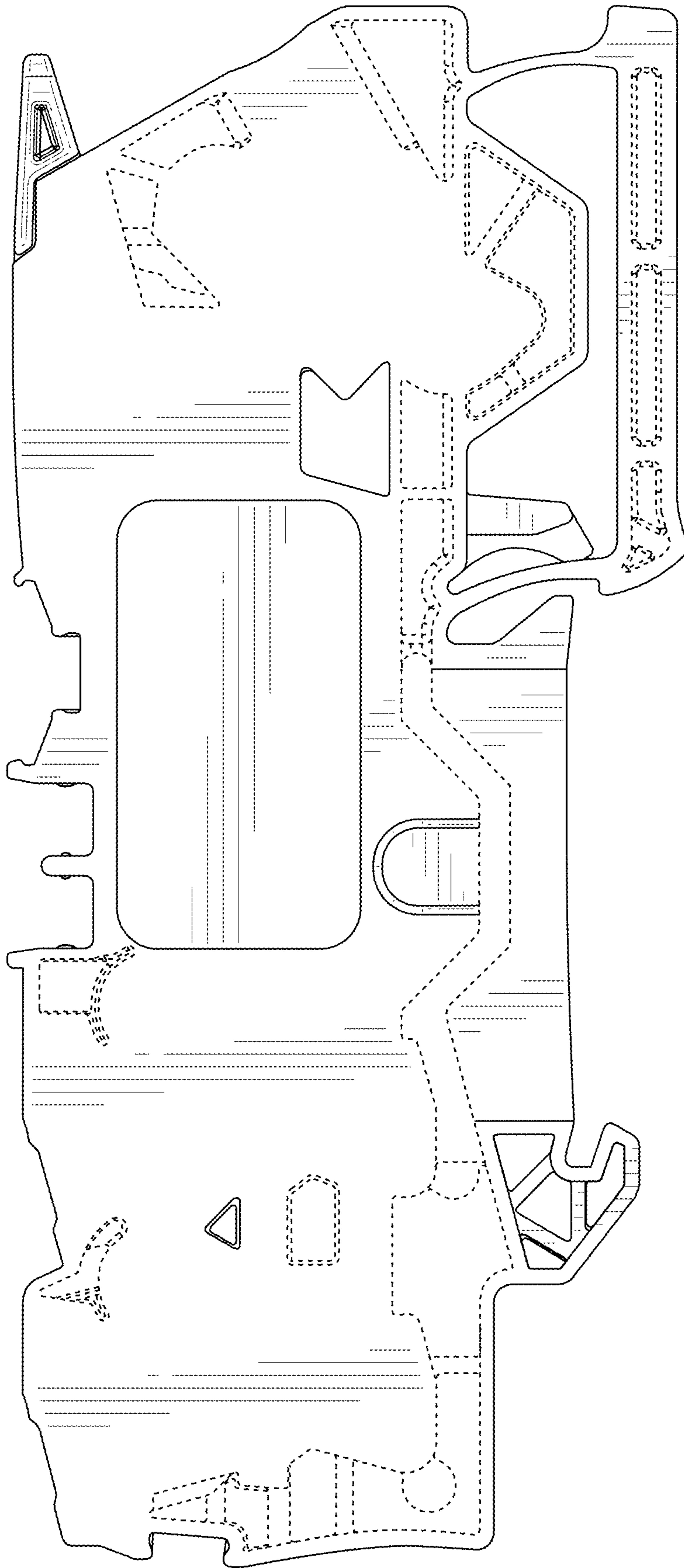

FIG. 8

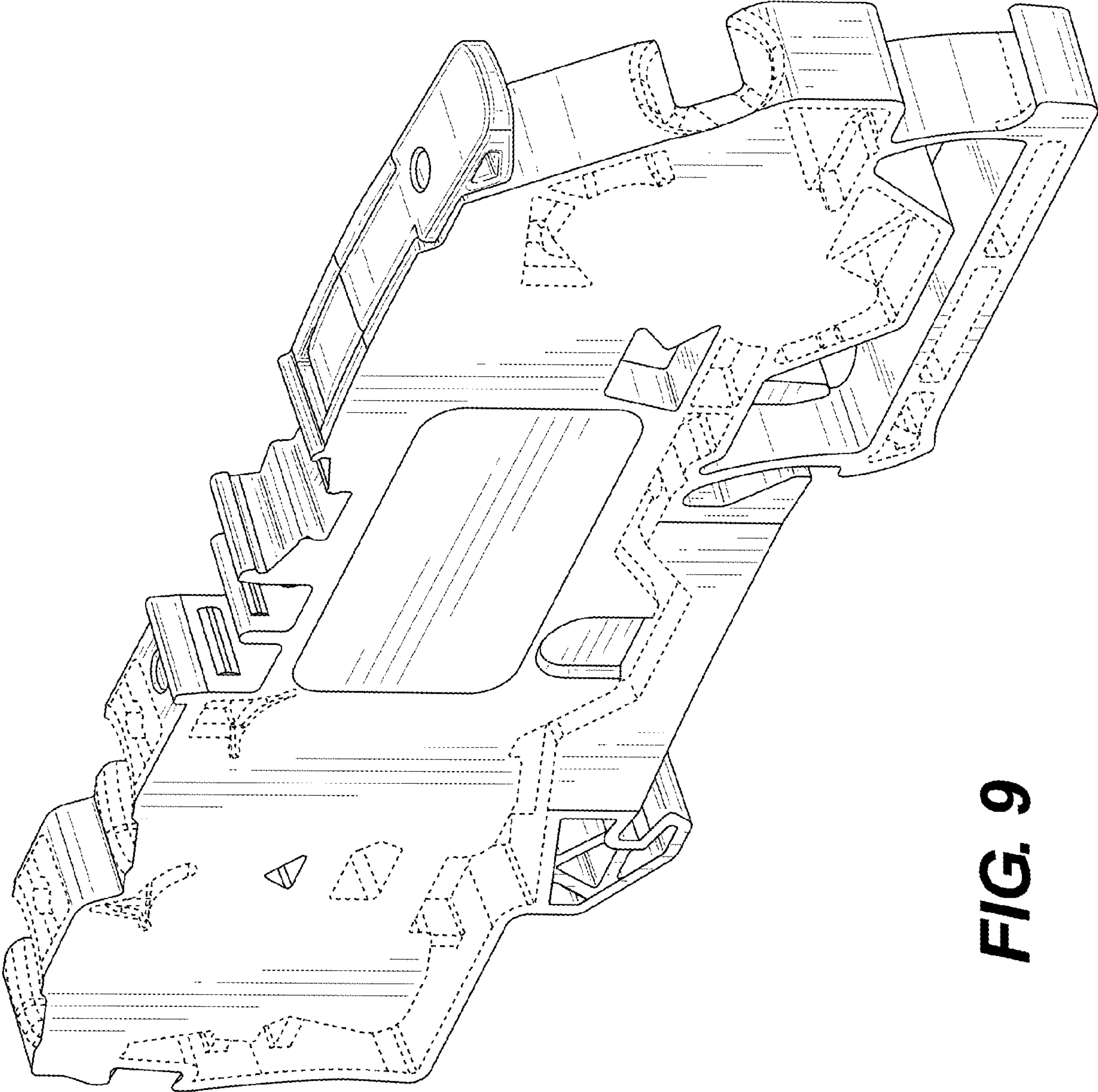

FIG. 9

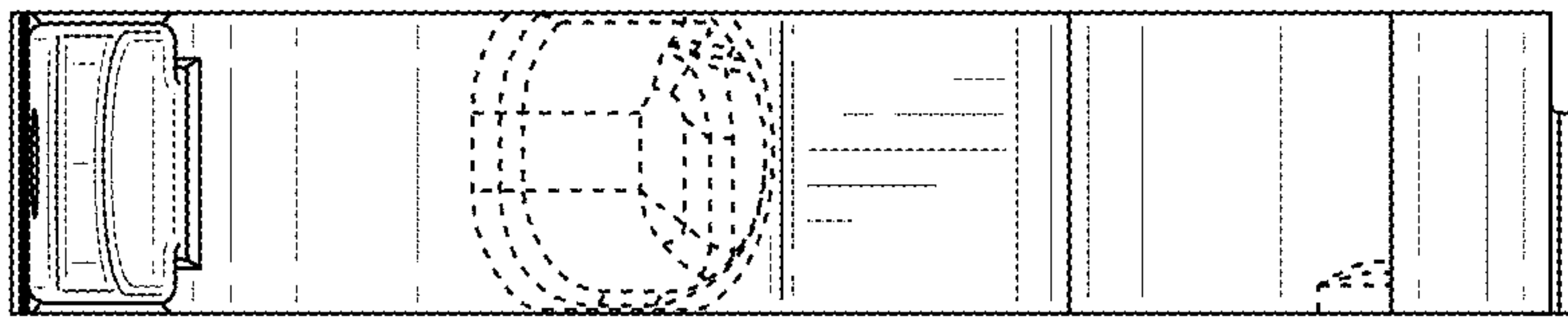

FIG. 10

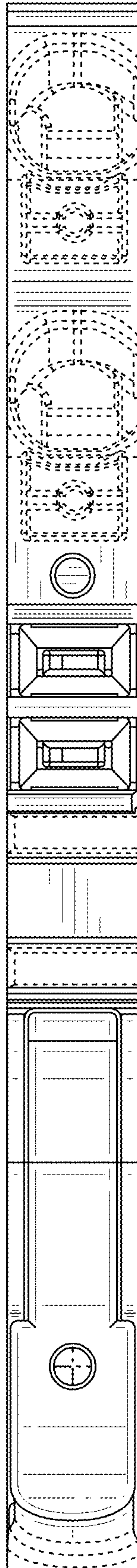

FIG. 11

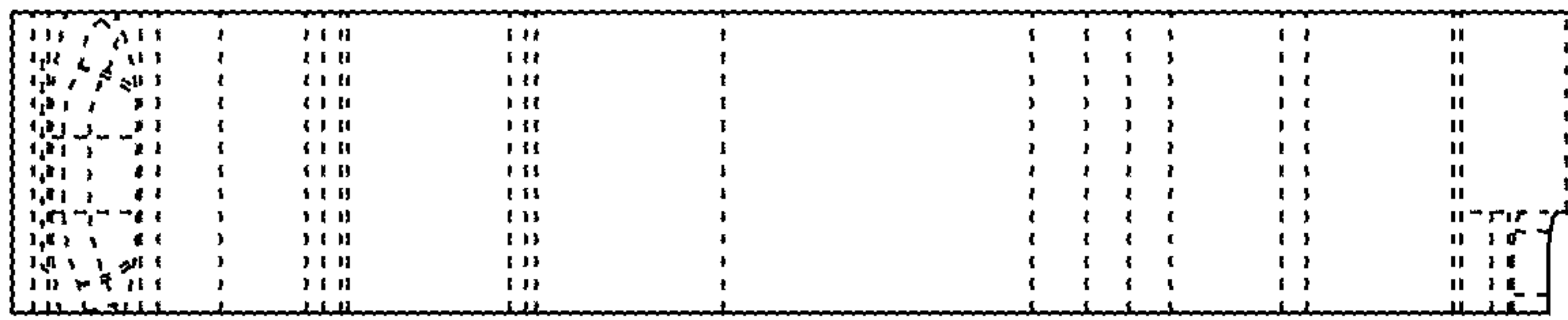

FIG. 12

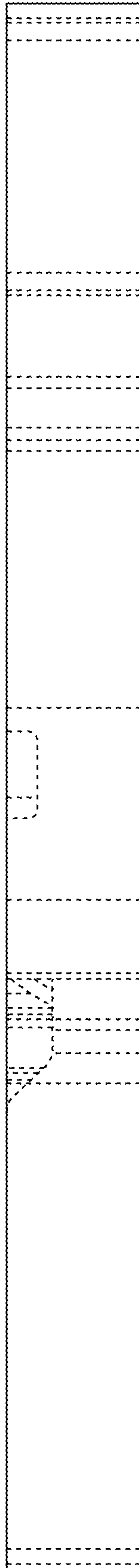

FIG. 13

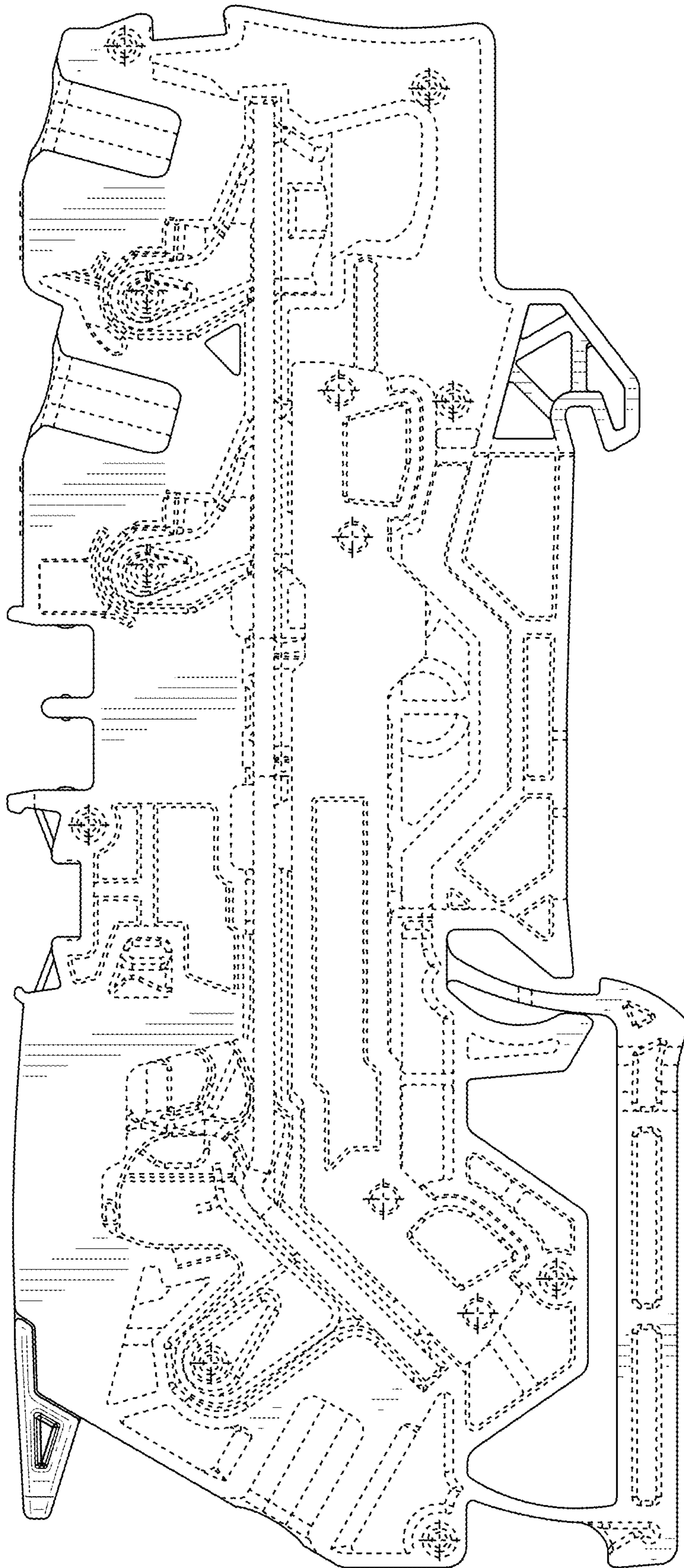

FIG. 14