



US00D910558S

(12) **United States Design Patent** (10) **Patent No.:** **US D910,558 S**
Lin (45) **Date of Patent:** **** Feb. 16, 2021**

(54) **PORTABLE POWER CHARGER**

G06F 3/023; G06F 3/038; G06F 3/0626;
G06F 3/0658; G06F 9/4413

(71) Applicant: **Guangzhou Roiskin Electrical
Technology Co., Ltd.**, Guangzhou (CN)

See application file for complete search history.

(72) Inventor: **Sam Lin**, Guangzhou (CN)

(56) **References Cited**

(73) Assignee: **GUANGZHOU ROISKIN
ELECTRICAL TECHNOLOGY CO.,
LTD.**, Guangzhou (CN)

U.S. PATENT DOCUMENTS

(**) Term: **15 Years**

5,613,863 A * 3/1997 Klaus H01R 27/00
439/131
D478,546 S * 8/2003 Andre D13/110
D647,476 S * 10/2011 Ciou D13/110
D731,970 S * 6/2015 Kamath D13/110
D741,796 S * 10/2015 Robinson D13/108
D762,173 S * 7/2016 Solomon D13/110
D820,207 S * 6/2018 Lemelson D13/110

(21) Appl. No.: **29/717,624**

* cited by examiner

(22) Filed: **Dec. 18, 2019**

(30) **Foreign Application Priority Data**

Primary Examiner — Derrick E Holland

Jul. 23, 2019 (CN) 2019 3 0393886

(74) *Attorney, Agent, or Firm* — Ward and Smith, P.A.;
Ryan K. Simmons

(51) **LOC (13) Cl.** **13-02**

(57) **CLAIM**

(52) **U.S. Cl.**
USPC **D13/110**

The ornamental design for a portable power charger, as
shown and described.

(58) **Field of Classification Search**

DESCRIPTION

USPC ... D13/110, 103, 107, 108, 118, 123, 137.1,
D13/137.4, 138.1, 147, 162, 168, 169,
D13/174, 177, 184, 199; D14/240, 242,
D14/257, 356, 357, 432, 433, 438, 480.1,
D14/480.3
CPC H05K 5/00; H05K 5/02; H05K 5/0247;
H05K 7/00; H05K 7/20; H05K 7/20136;
H05K 7/20154; H05K 7/209; H02M 7/00;
H02M 7/003; H02M 2001/009; H02J
7/0042; Y10T 307/367; Y02E 60/12;
Y02E 60/50; H01M 2/02; H01M 2/025;
H01M 2/0207; H01M 2/0212; H01M
10/44; H01R 13/60; H01R 13/72; H01R
13/6658; H01R 25/003; H01R 25/006;

FIG. 1 is a front elevation view a portable power charger
showing a new design;
FIG. 2 is a rear elevation view thereof;
FIG. 3 is a left side elevation view thereof;
FIG. 4 is a right side elevation view thereof;
FIG. 5 is a top plan view thereof;
FIG. 6 is a bottom plan view thereof;
FIG. 7 is a front perspective view thereof; and,
FIG. 8 is a rear perspective view thereof.
The shade lines shown in the drawings indicate the character
and contour of surfaces represented and should not be
confused with surface ornamentation.

1 Claim, 8 Drawing Sheets

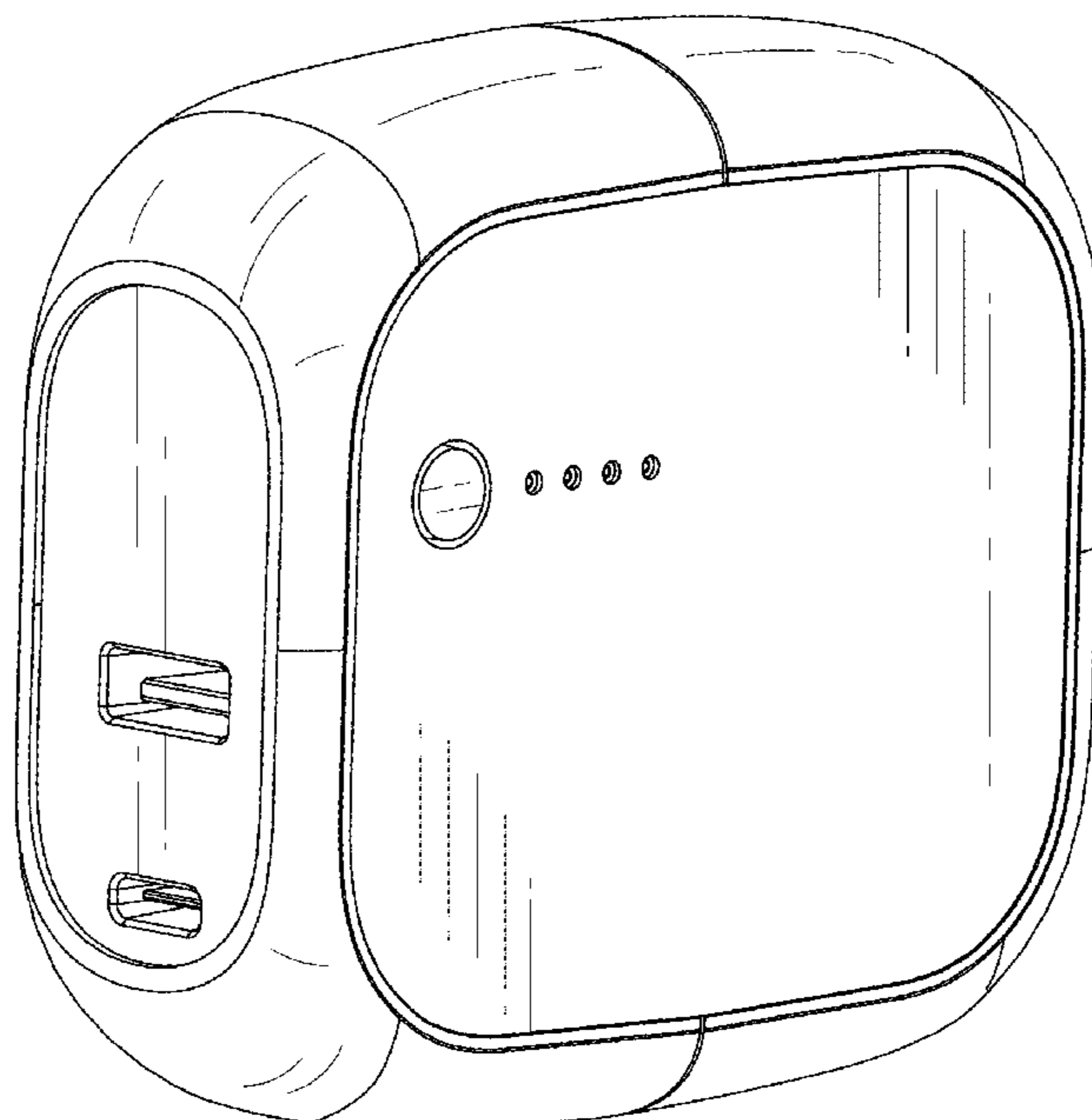

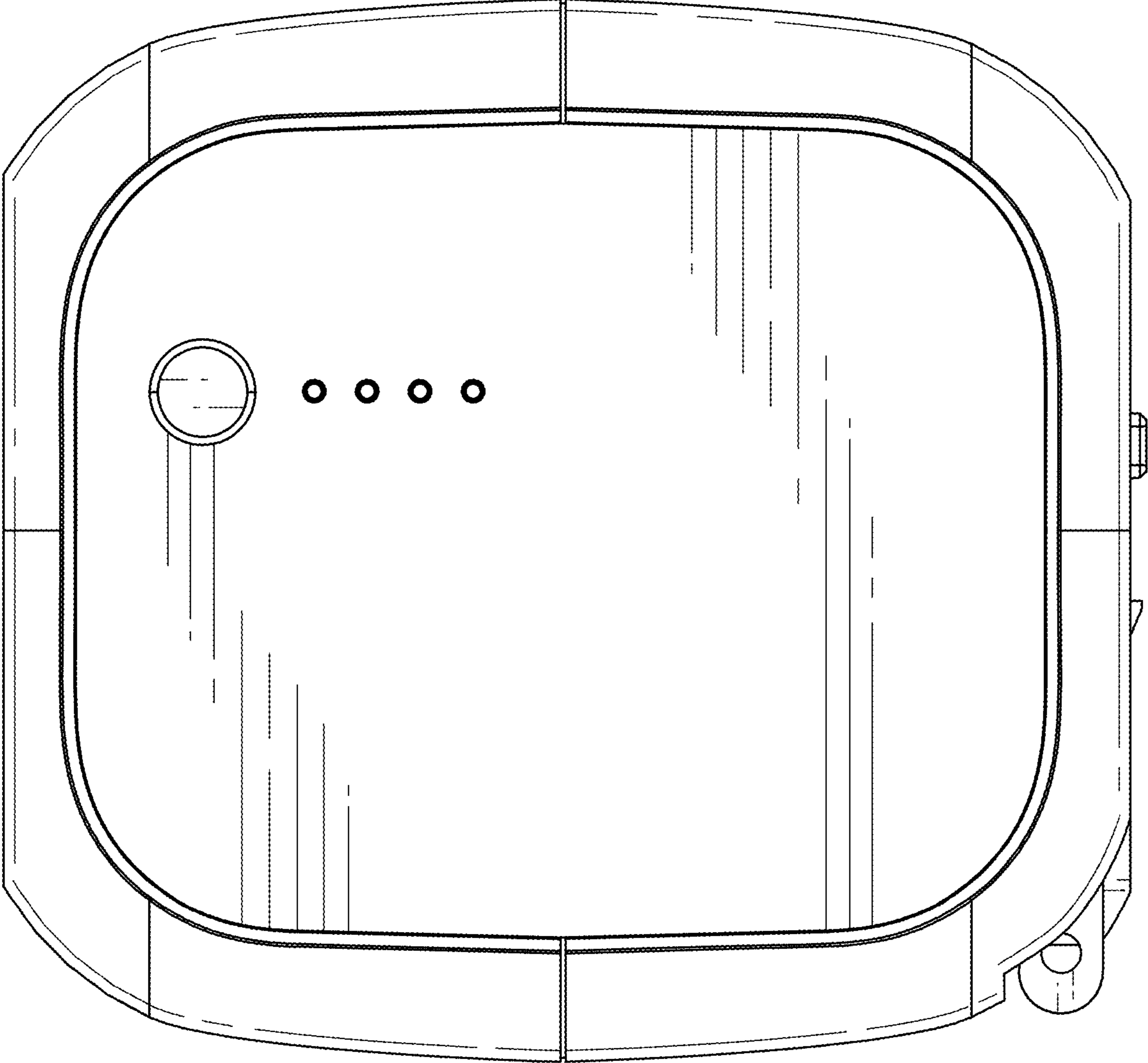

FIG. 1

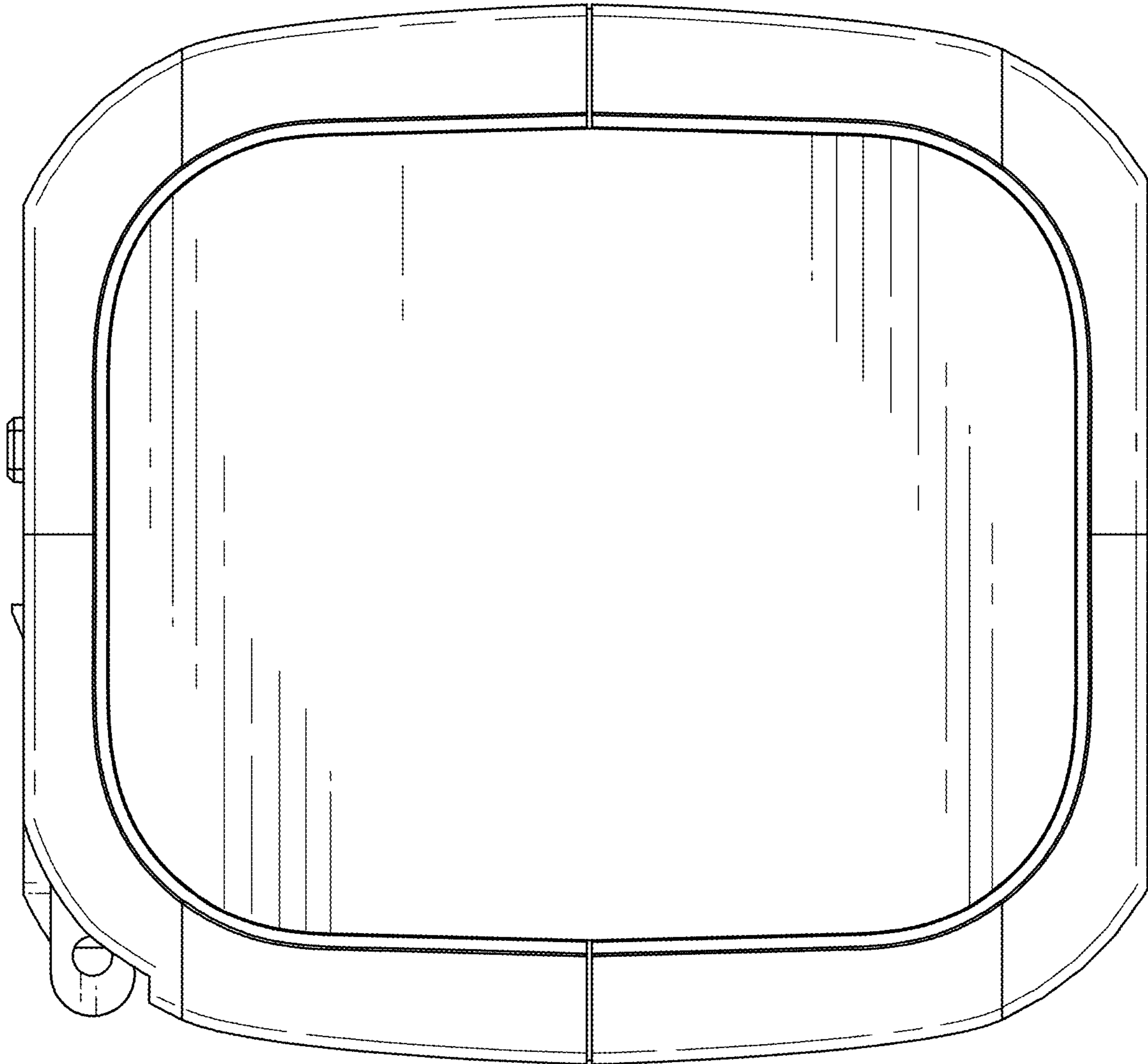

FIG. 2

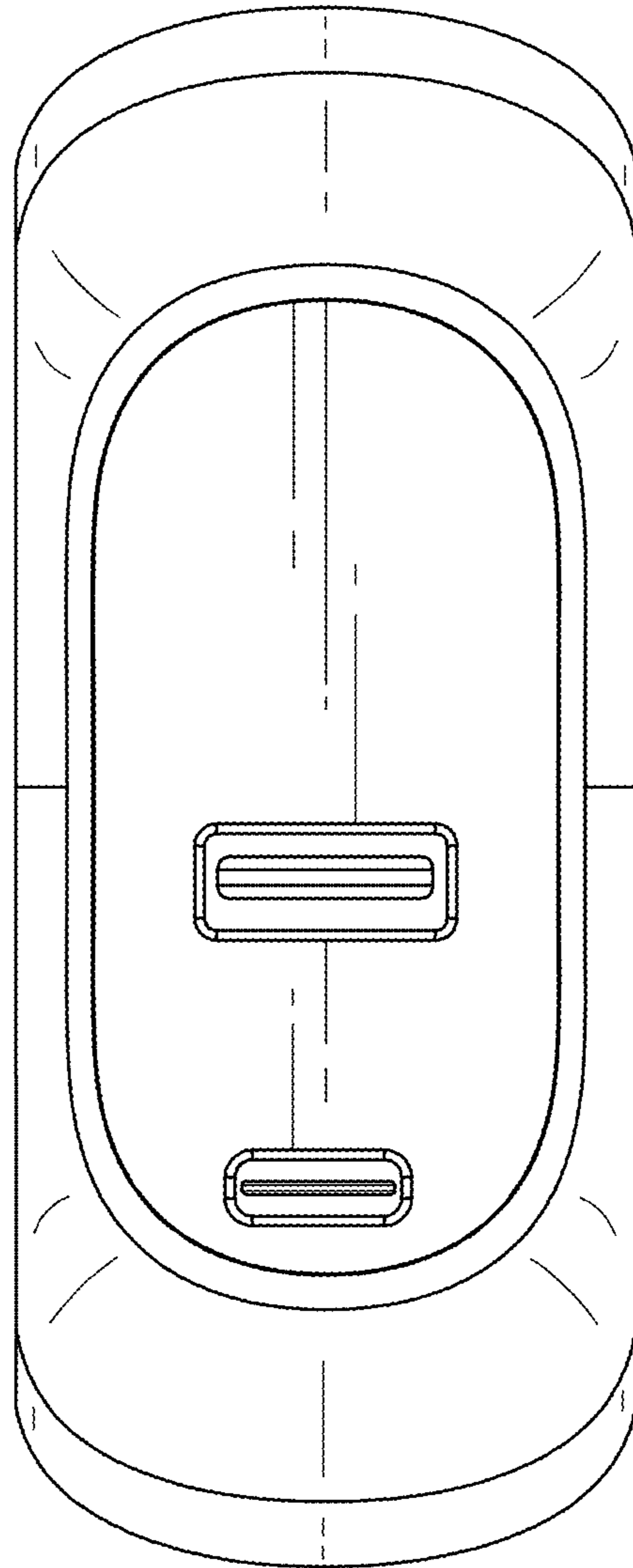

FIG. 3

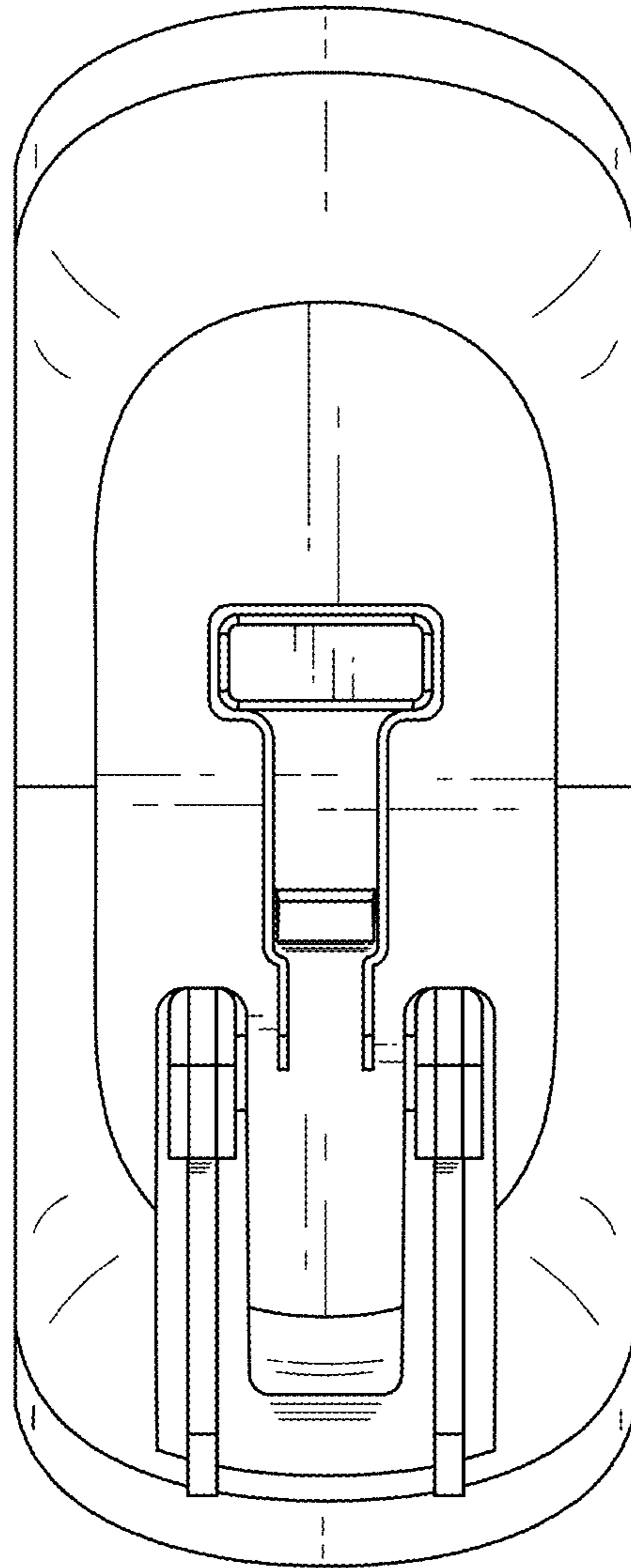

FIG. 4

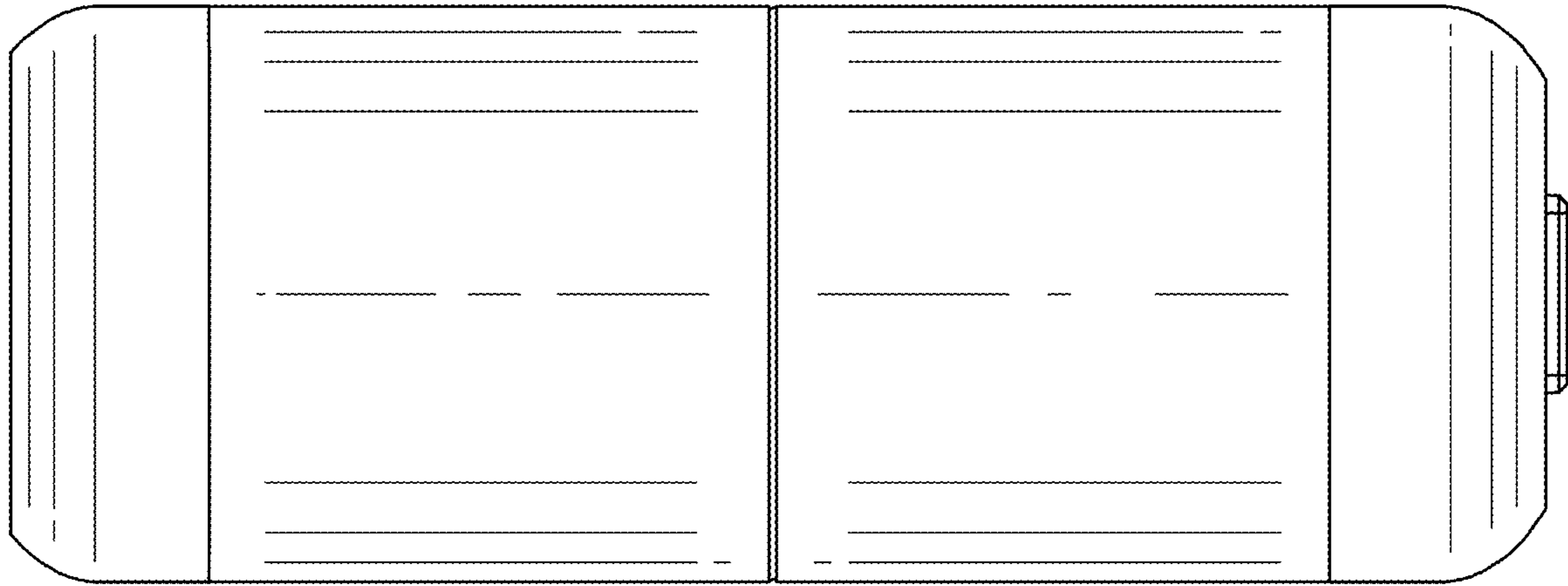

FIG. 5

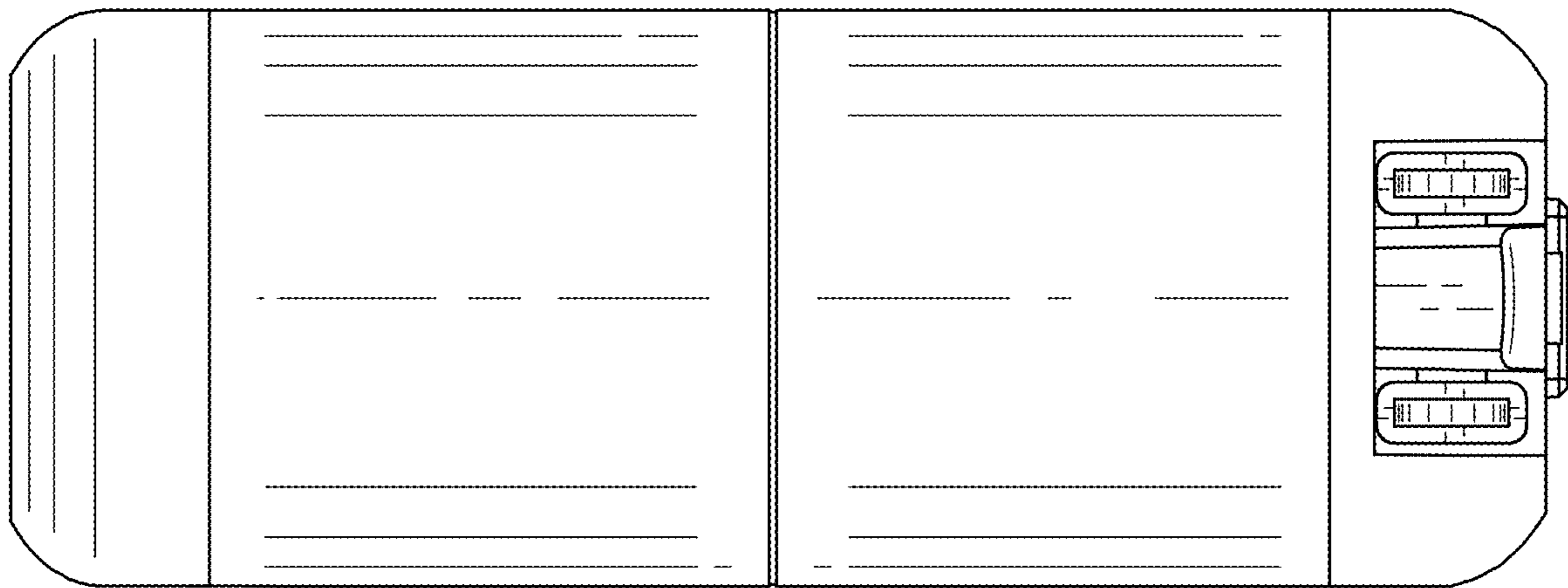

FIG. 6

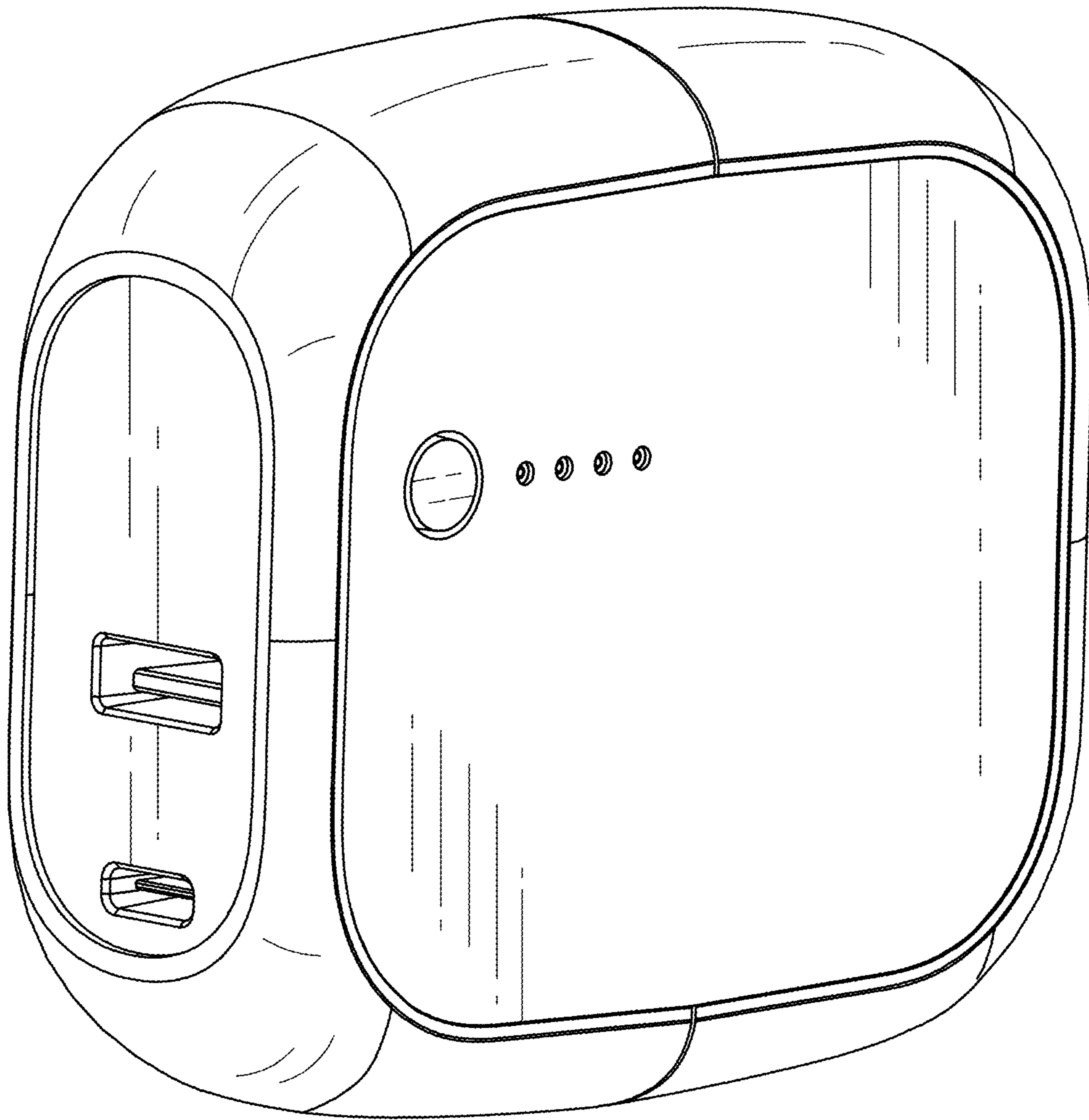

FIG. 7

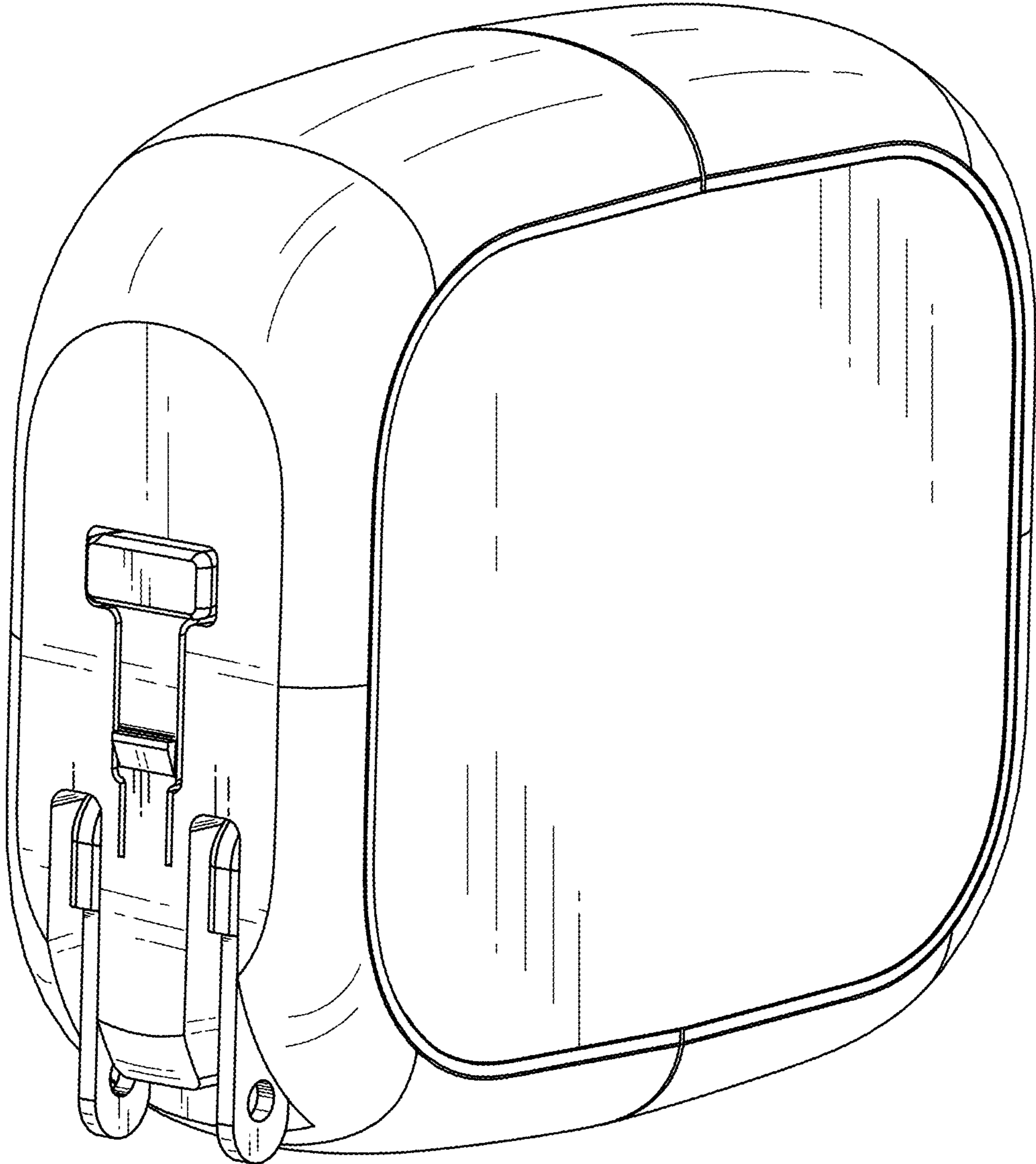

FIG. 8