



US00D910484S

(12) **United States Design Patent** (10) **Patent No.:** **US D910,484 S**
Perlin (45) **Date of Patent:** **** Feb. 16, 2021**

(54) **DECORATION**

DESCRIPTION

(71) Applicant: **Ari Samuel Perlin**, Sherman Oaks, CA (US)
(72) Inventor: **Ari Samuel Perlin**, Sherman Oaks, CA (US)
(**) Term: **15 Years**
(21) Appl. No.: **29/665,686**
(22) Filed: **Oct. 5, 2018**
(51) **LOC (13) Cl.** **11-99**
(52) **U.S. Cl.**
USPC **D11/184**
(58) **Field of Classification Search**
USPC D14/230; D8/14; D32/14, 34-25, 46, D32/50-52; D7/505; D4/128; D26/7,
(Continued)

FIG. 1 is a perspective front view of a decoration embodying the new design, according to one embodiment;
FIG. 2 is a front view thereof;
FIG. 3 is a rear view thereof;
FIG. 4 is a left side view thereof;
FIG. 5 is a right side view thereof;
FIG. 6 is a top view thereof; and
FIG. 7 is a bottom view thereof.
FIG. 8 is a perspective front view of a decoration embodying the new design, according to another embodiment;
FIG. 9 is a front view thereof;
FIG. 10 is a rear view thereof;
FIG. 11 is a left side view thereof;
FIG. 12 is a right side view thereof;
FIG. 13 is a top view thereof; and
FIG. 14 is a bottom view thereof.
FIG. 15 is a perspective front view of a decoration embodying the new design, according to another embodiment;
FIG. 16 is a front view thereof;
FIG. 17 is a rear view thereof;
FIG. 18 is a left side view thereof;
FIG. 19 is a right side view thereof;
FIG. 20 is a top view thereof; and
FIG. 21 is a bottom view thereof.
FIG. 22 is a front view of a decoration embodying the new design, according to another embodiment;
FIG. 23 is a rear view thereof;
FIG. 24 is a left side view thereof;
FIG. 25 is a right side view thereof;
FIG. 26 is a top view thereof; and
FIG. 27 is a bottom view thereof.
FIG. 28 is a front view of a decoration embodying the new design, according to another embodiment;
FIG. 29 is a rear view thereof;
FIG. 30 is a left side view thereof;
FIG. 31 is a right side view thereof;
FIG. 32 is a top view thereof; and
FIG. 33 is a bottom view thereof.
Broken lines are used to illustrate portions of the decoration that form no part of the claimed design. The appearance of any portion of the article between the break lines forms no part of the claimed design.

(56) **References Cited**

U.S. PATENT DOCUMENTS

1,714,674 A * 5/1929 King B44C 5/00
431/126
D107,157 S * 11/1937 Thompson D32/35
(Continued)

OTHER PUBLICATIONS

Chapter 15: Fluid Power Actuators, part 1 | Hydraulics & Pneumatics, website publish date 2007, <https://www.hydraulicspneumatics.com/technologies/other-technologies/article/21884185/> . . . site visited Jun. 21, 2020.*

(Continued)

Primary Examiner — John R Yeh

(74) *Attorney, Agent, or Firm* — Knobbe, Martens, Olson & Bear LLP

(57) **CLAIM**

The ornamental design for a decoration, as shown and described.

(Continued)

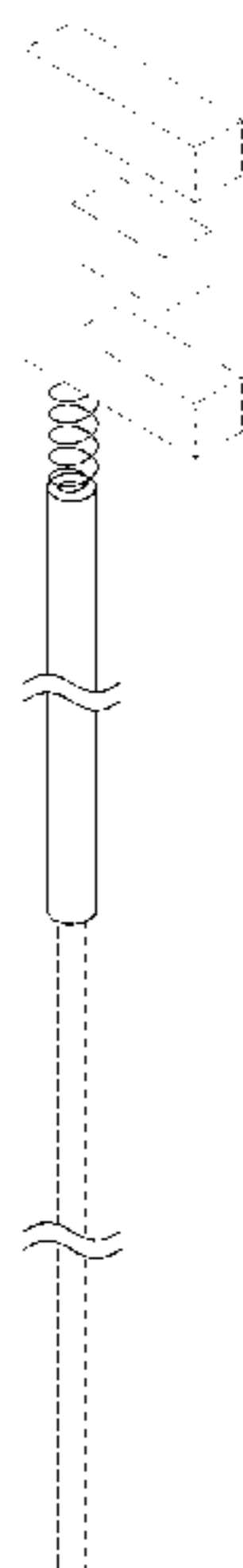

US D910,484 S

Page 2

The decoration can be a party decoration (e.g., for birthdays, holidays, special occasions), and for example can be inserted in cakes and gifts (e.g., flower pots).

1 Claim, 18 Drawing Sheets

(58) Field of Classification Search

USPC D26/10, 16; D11/134, 140–142, 146,
D11/148, 152, 184
CPC H01Q 9/04; A47G 21/18; B65D 65/00;
F21V 35/00; B44C 5/00; G09F 19/00
See application file for complete search history.

(56) References Cited

U.S. PATENT DOCUMENTS

D107,562 S * 12/1937 Thomas D14/230
D119,763 S * 4/1940 Nelson D32/35
2,316,342 A * 4/1943 Krieg F21V 35/00
431/125
2,785,399 A * 3/1957 Harris H01Q 1/02
343/796
2,980,456 A * 4/1961 McMullin F16B 7/105
403/328
3,046,178 A * 7/1962 Tupper B29C 48/50
156/167
3,748,716 A * 7/1973 Fidler B25B 27/30
29/228
D247,557 S * 3/1978 Hemmy D26/16
4,118,708 A * 10/1978 Lozar H01Q 1/10
343/901
4,277,872 A * 7/1981 Lewis B25B 27/08
29/229
D270,762 S * 9/1983 Kaufman D24/119
D274,273 S * 6/1984 Auerbach D32/35
4,984,588 A * 1/1991 Stewart, Jr. A24D 1/00
131/331
D334,287 S * 3/1993 Ingles D4/102
D337,889 S * 8/1993 Benson 15/179
D338,426 S * 8/1993 Horvath 431/290
D364,003 S * 11/1995 Benson D24/119
D368,553 S * 4/1996 Welschoff D19/163
5,586,694 A * 12/1996 Breidenbach A45D 34/02
222/183

D393,115 S * 3/1998 Bell D22/108
6,153,273 A * 11/2000 Lee Lin B44C 5/00
40/406
6,439,083 B1 * 8/2002 Molstad B23Q 16/001
417/388
D462,588 S * 9/2002 Kisby D21/679
D520,854 S * 5/2006 Barrett D8/307
D584,608 S * 1/2009 McBride D3/227
8,096,723 B2 * 1/2012 Bae B25G 1/06
401/139
D680,819 S * 4/2013 Patel D7/676
D706,161 S * 6/2014 Madrid D11/130
D789,637 S * 6/2017 Dobson, III D32/51
D853,193 S * 7/2019 Hartnett D7/505
2002/0088870 A1 * 7/2002 Banach A47G 21/18
239/33
2002/0157679 A1 * 10/2002 Yiu B65C 9/262
132/73
2004/0168936 A1 * 9/2004 Johnson A23G 3/563
206/308.1
2005/0227796 A1 * 10/2005 Murphy F42B 6/003
473/578
2006/0227530 A1 * 10/2006 Wang A47G 33/06
362/84
2007/0135015 A1 * 6/2007 Tellinghuisen G09F 19/00
446/27
2008/0273920 A1 * 11/2008 Shih B44C 5/00
403/169
2009/0061726 A1 * 3/2009 Levinson G09F 19/00
446/15
2009/0102386 A1 * 4/2009 Finkle G09F 19/00
315/117
2010/0265698 A1 * 10/2010 Chen B43K 29/10
362/118
2011/0151203 A1 * 6/2011 Nalley B44C 5/06
428/195.1
2012/0067909 A1 * 3/2012 Mattheus A47G 21/18
220/705
2014/0353452 A1 * 12/2014 Schwenk F16M 11/046
248/404
2020/0280181 A1 * 9/2020 Tarasinski B65H 59/04

OTHER PUBLICATIONS

Gold Unicorn Cake Decoration Topper, ebay 2020, <https://www.ebay.com/itm/153339269483> site visited Dec. 9, 2020.*

* cited by examiner

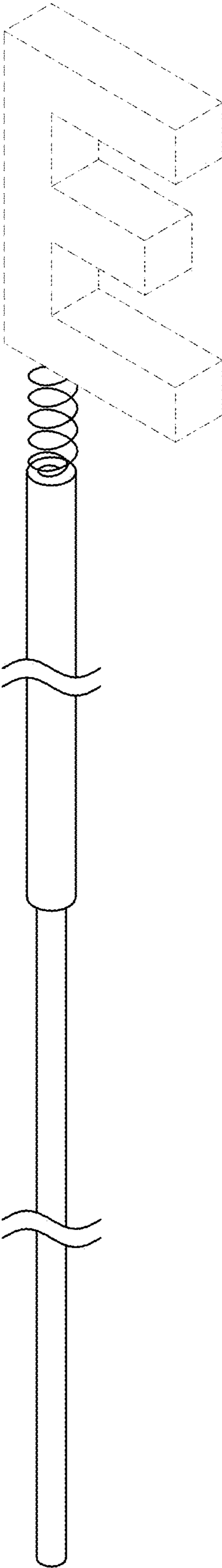

FIG. 1

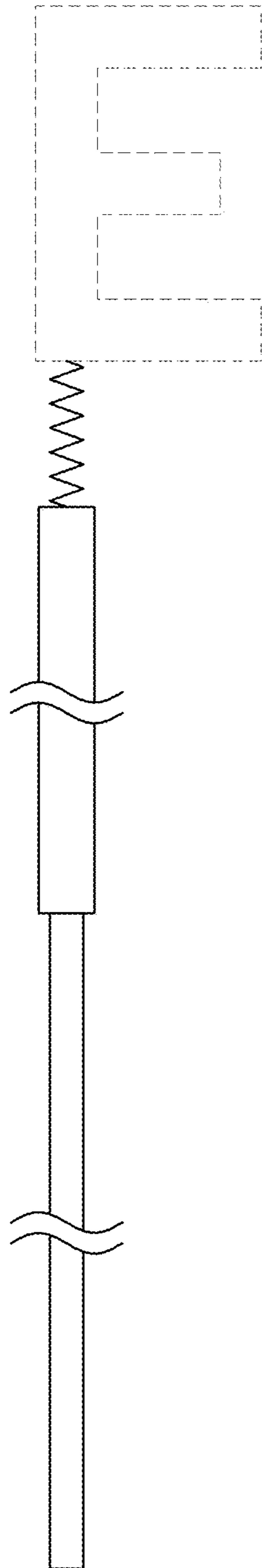

FIG. 2

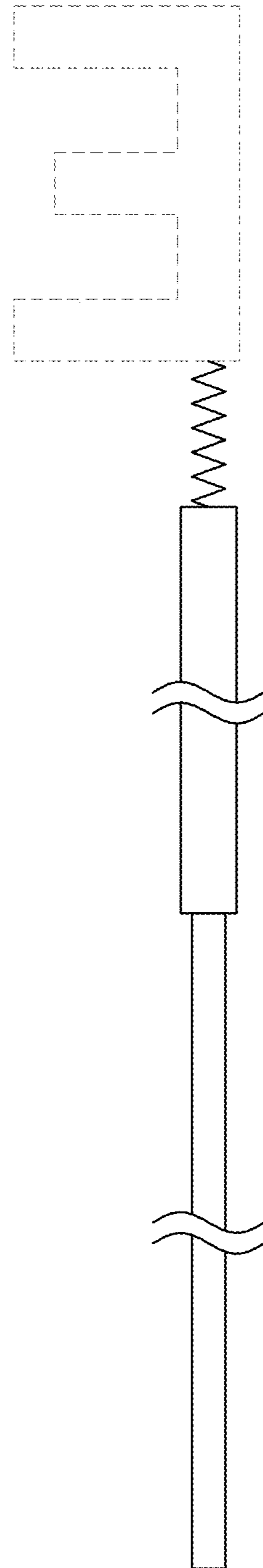

FIG. 3

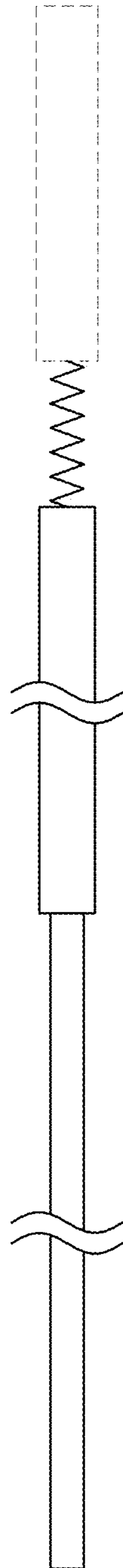

FIG. 4

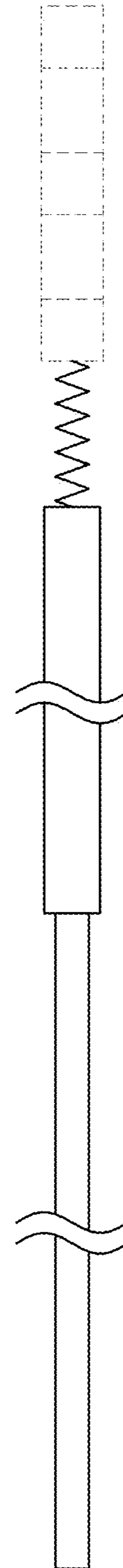

FIG. 5



FIG. 6



FIG. 7

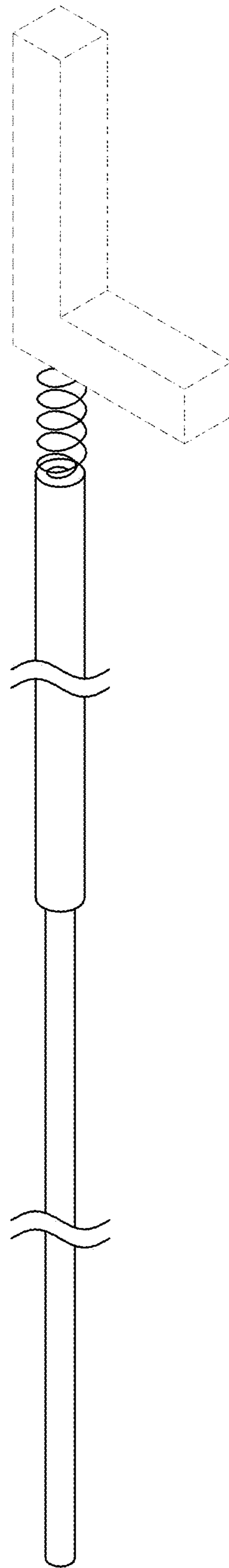

FIG. 8

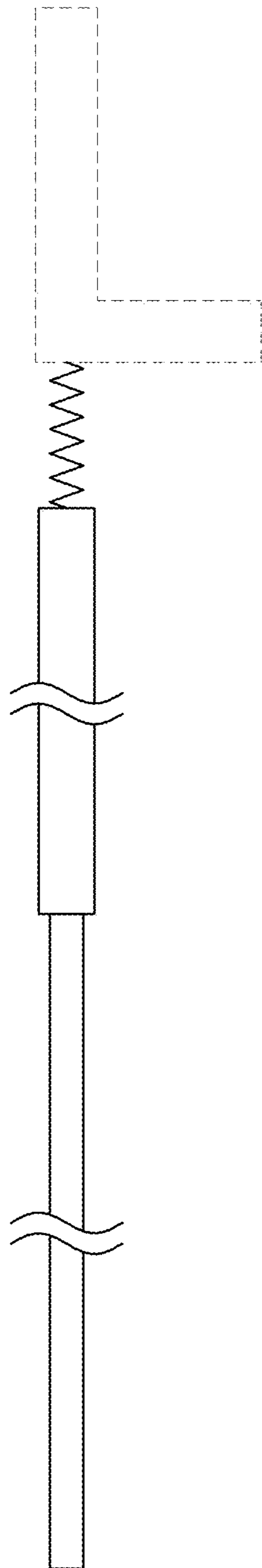

FIG. 9

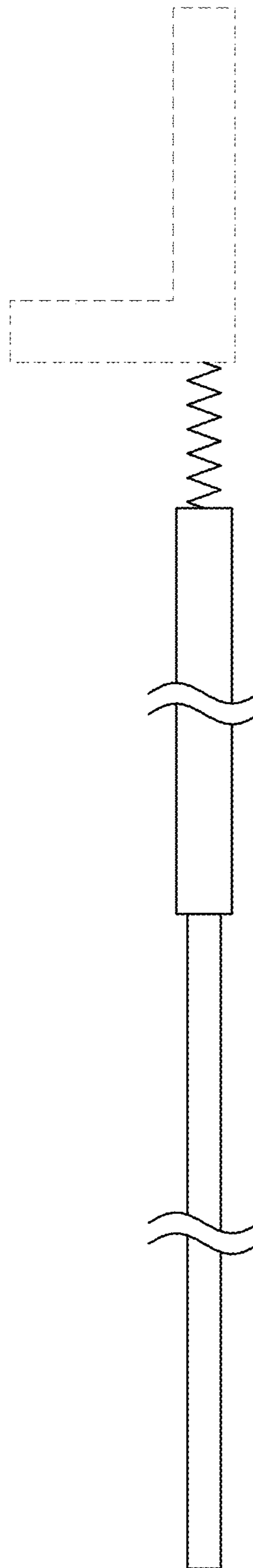

FIG. 10

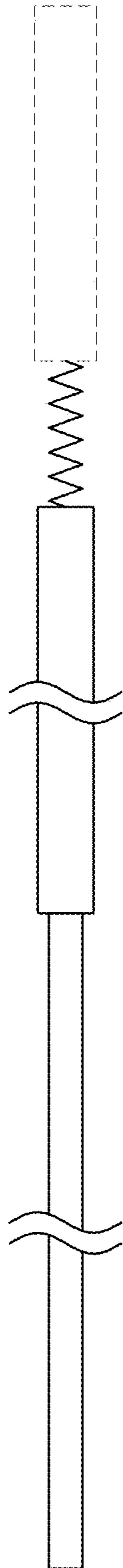

FIG. 11

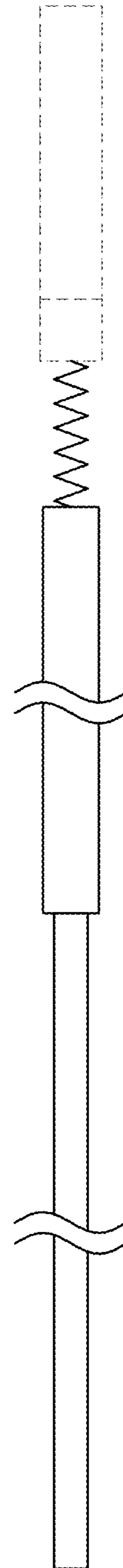

FIG. 12

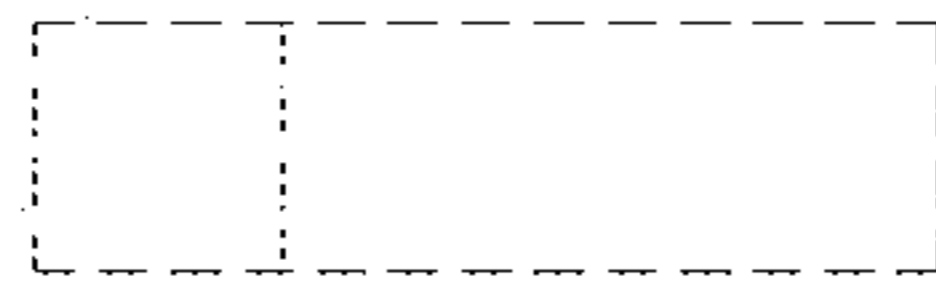

FIG. 13



FIG. 14

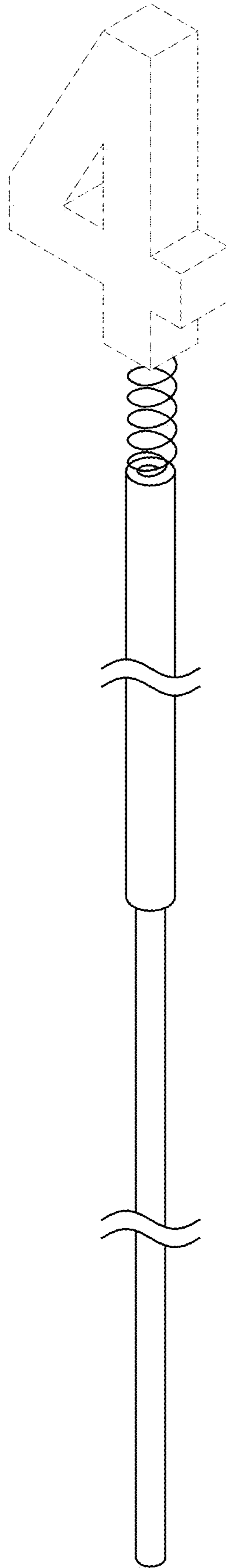

FIG. 15

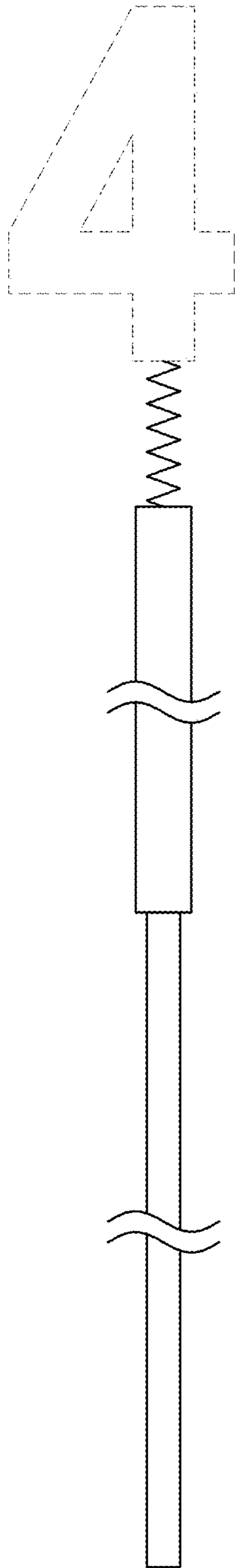

FIG. 16

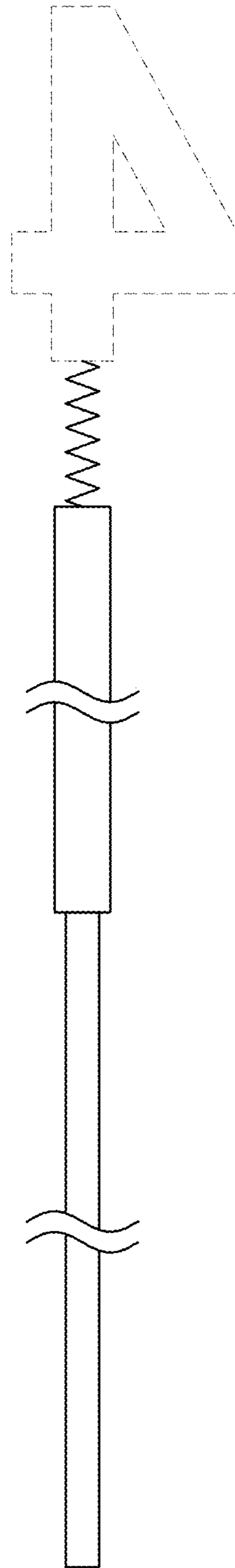

FIG. 17

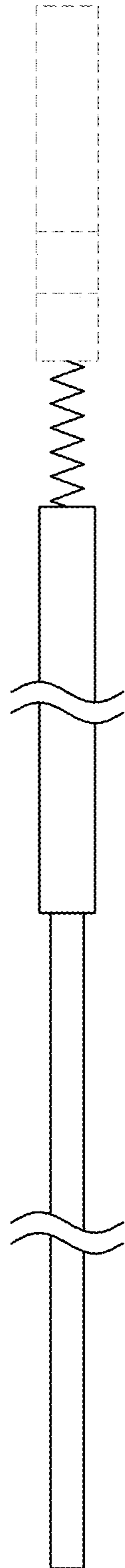

FIG. 18

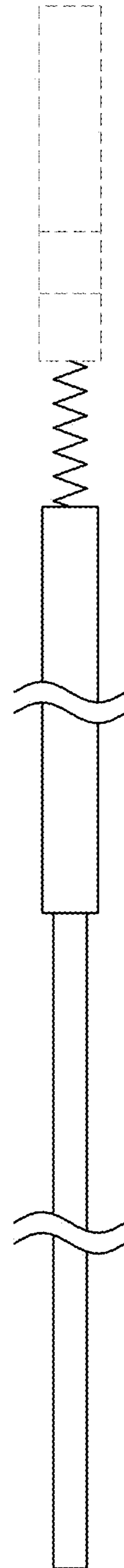

FIG. 19

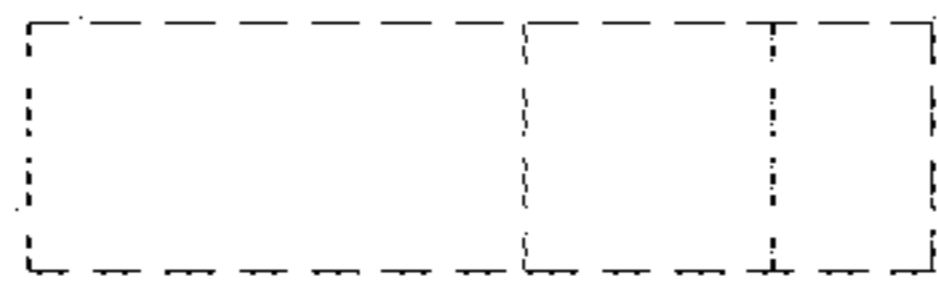

FIG. 20



FIG. 21

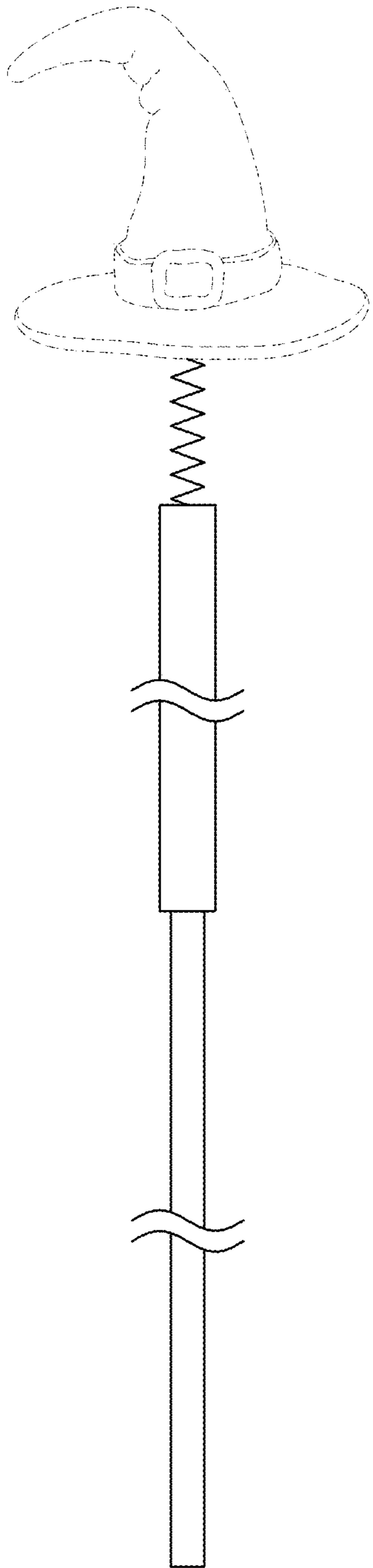

FIG. 22

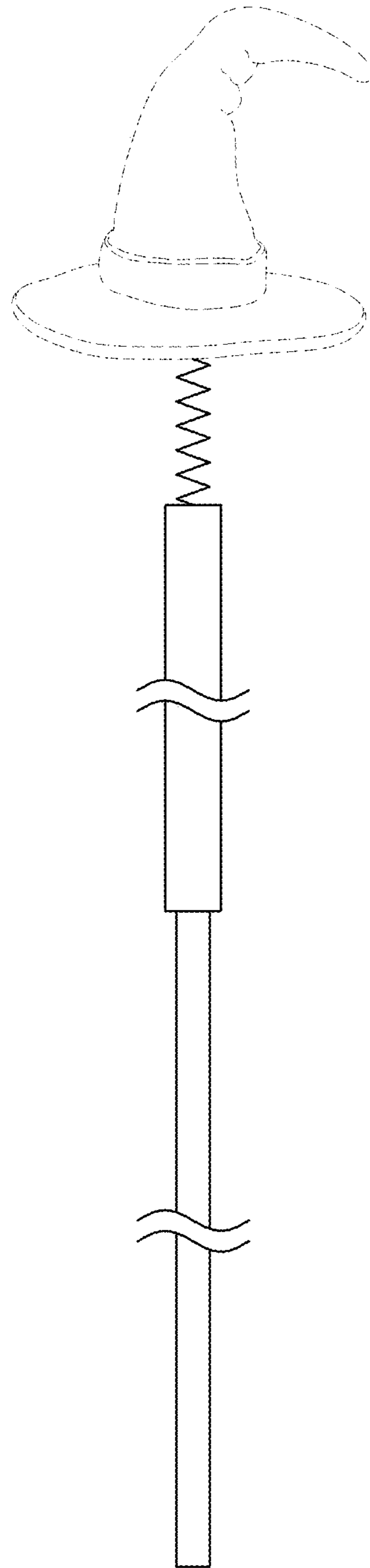

FIG. 23

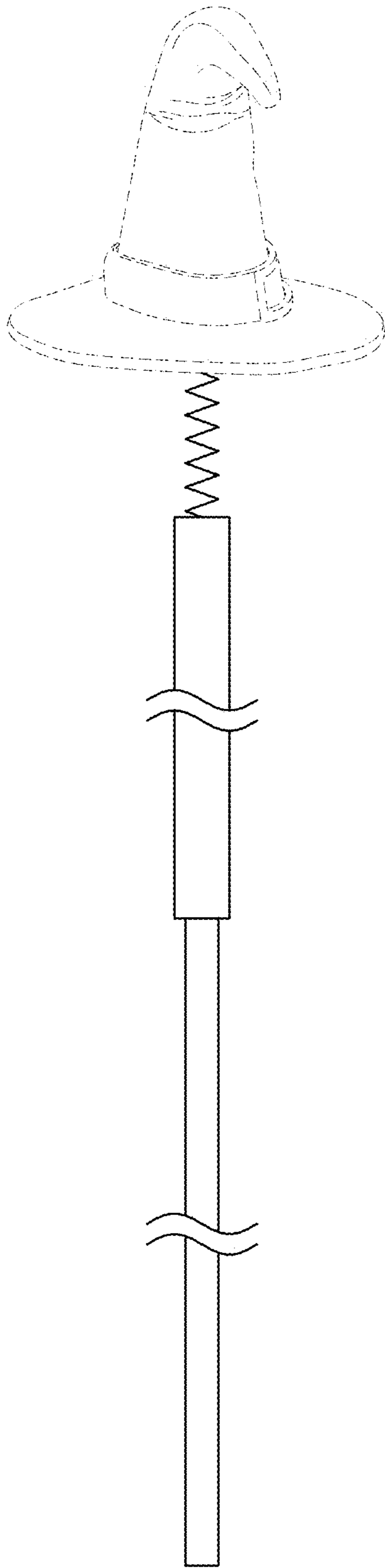

FIG. 24

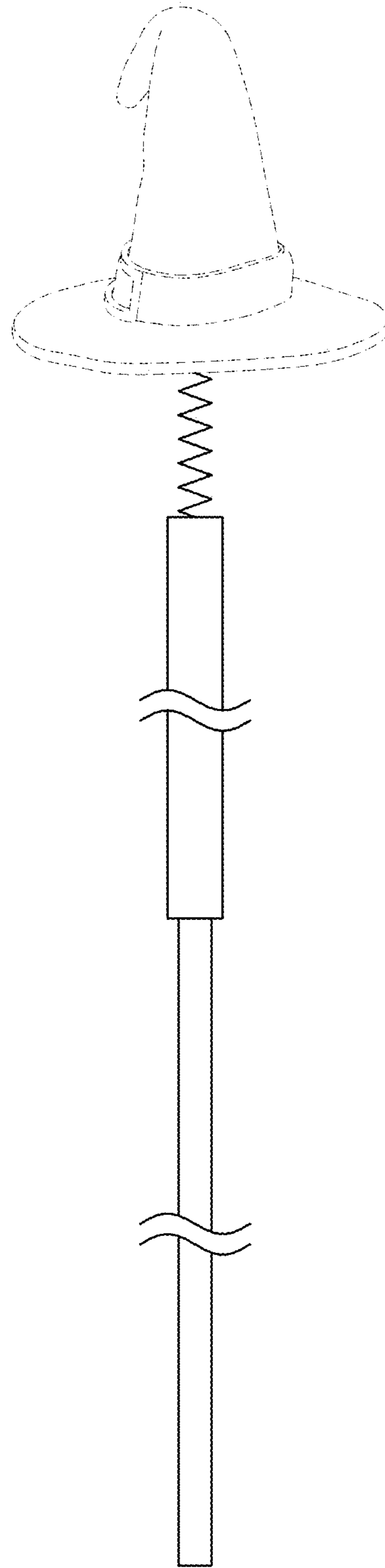

FIG. 25

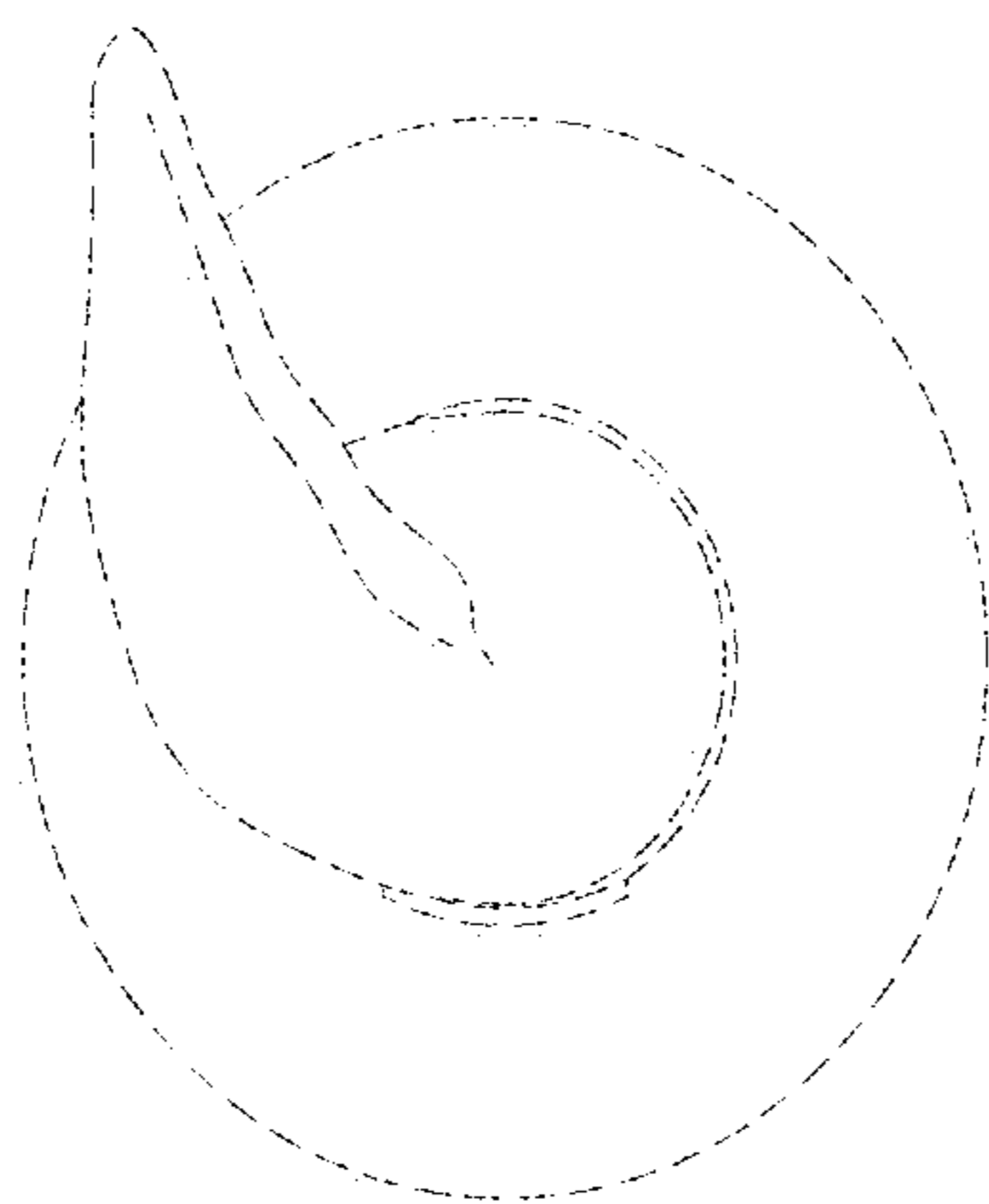

FIG. 26

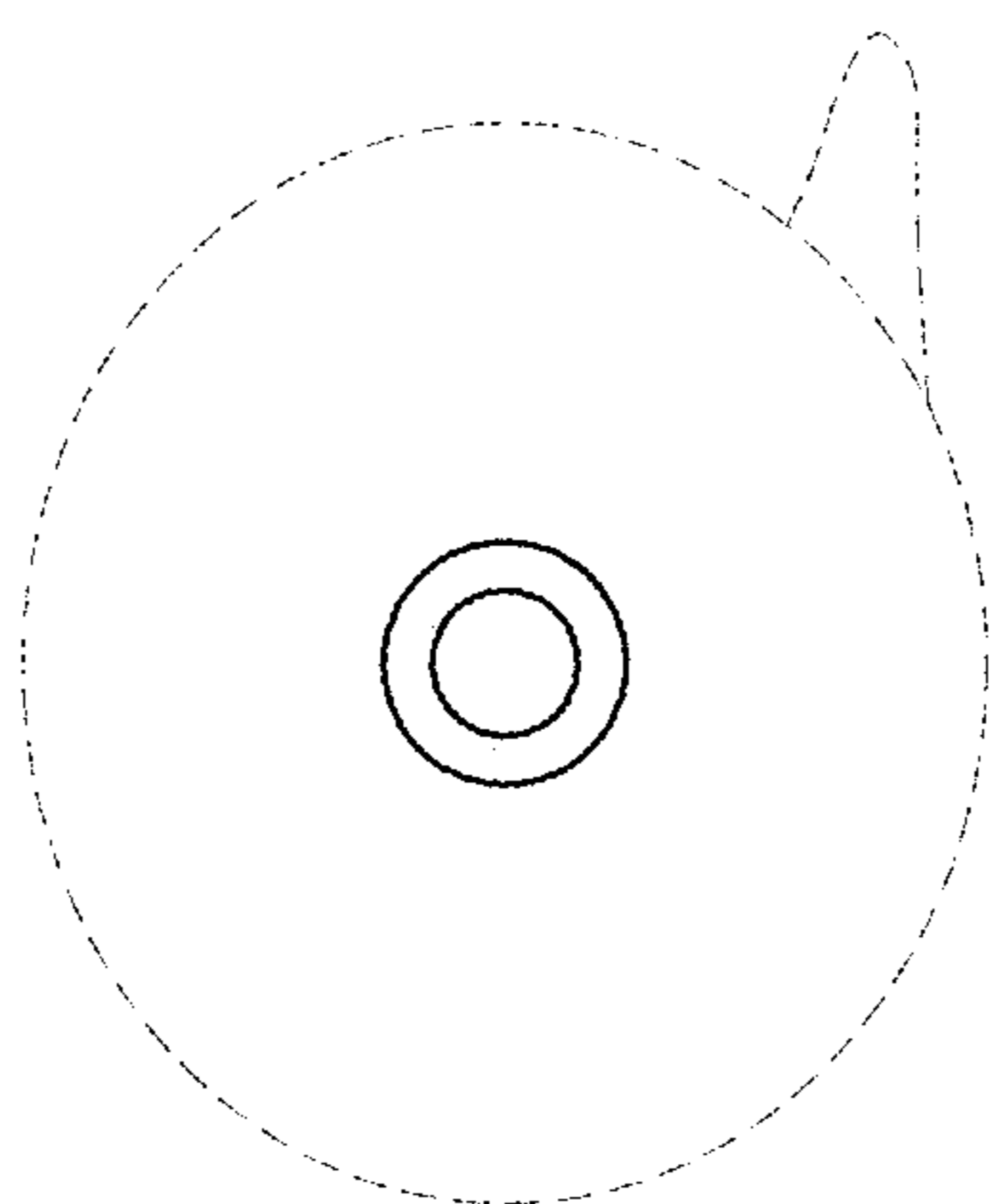

FIG. 27

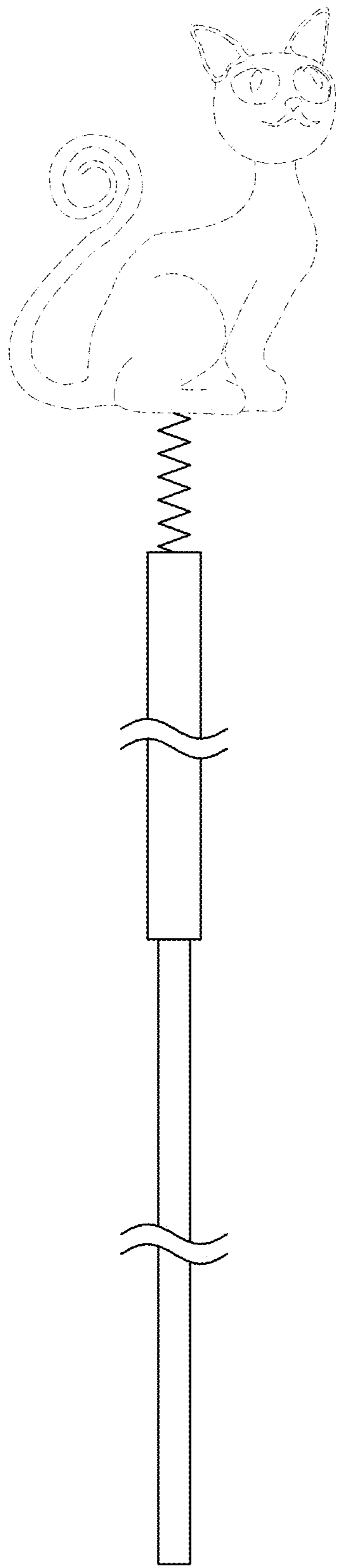

FIG. 28

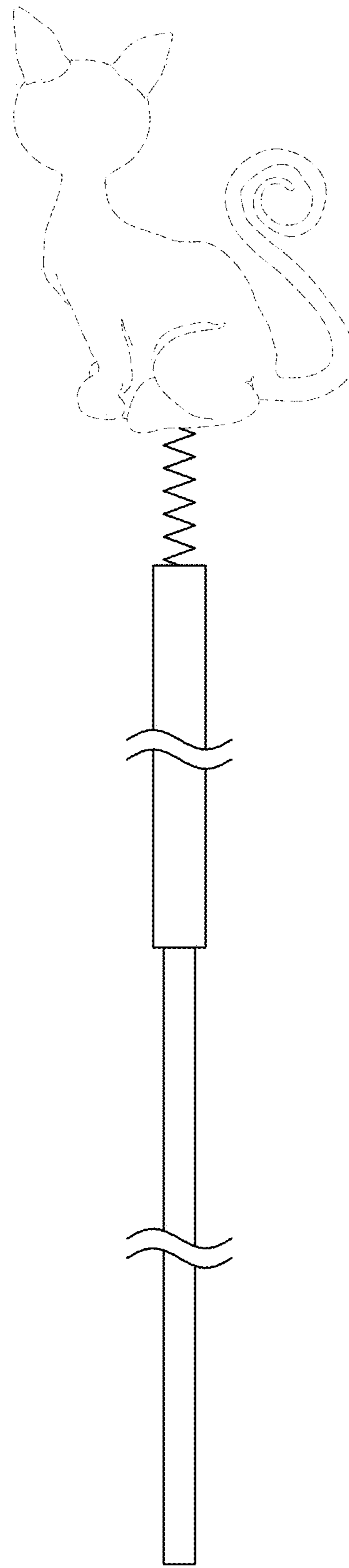

FIG. 29

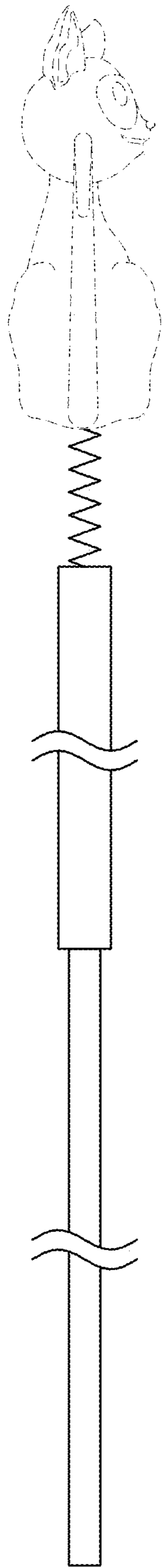

FIG. 30

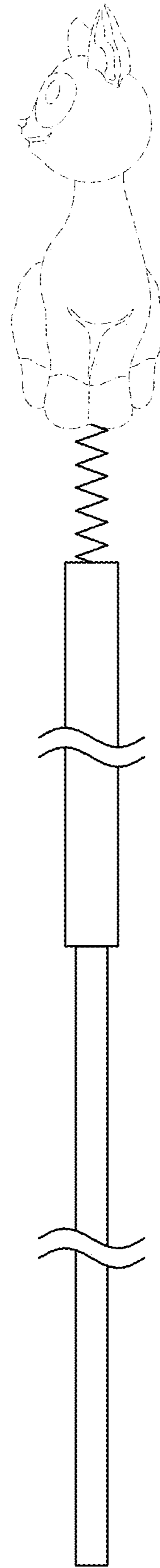

FIG. 31

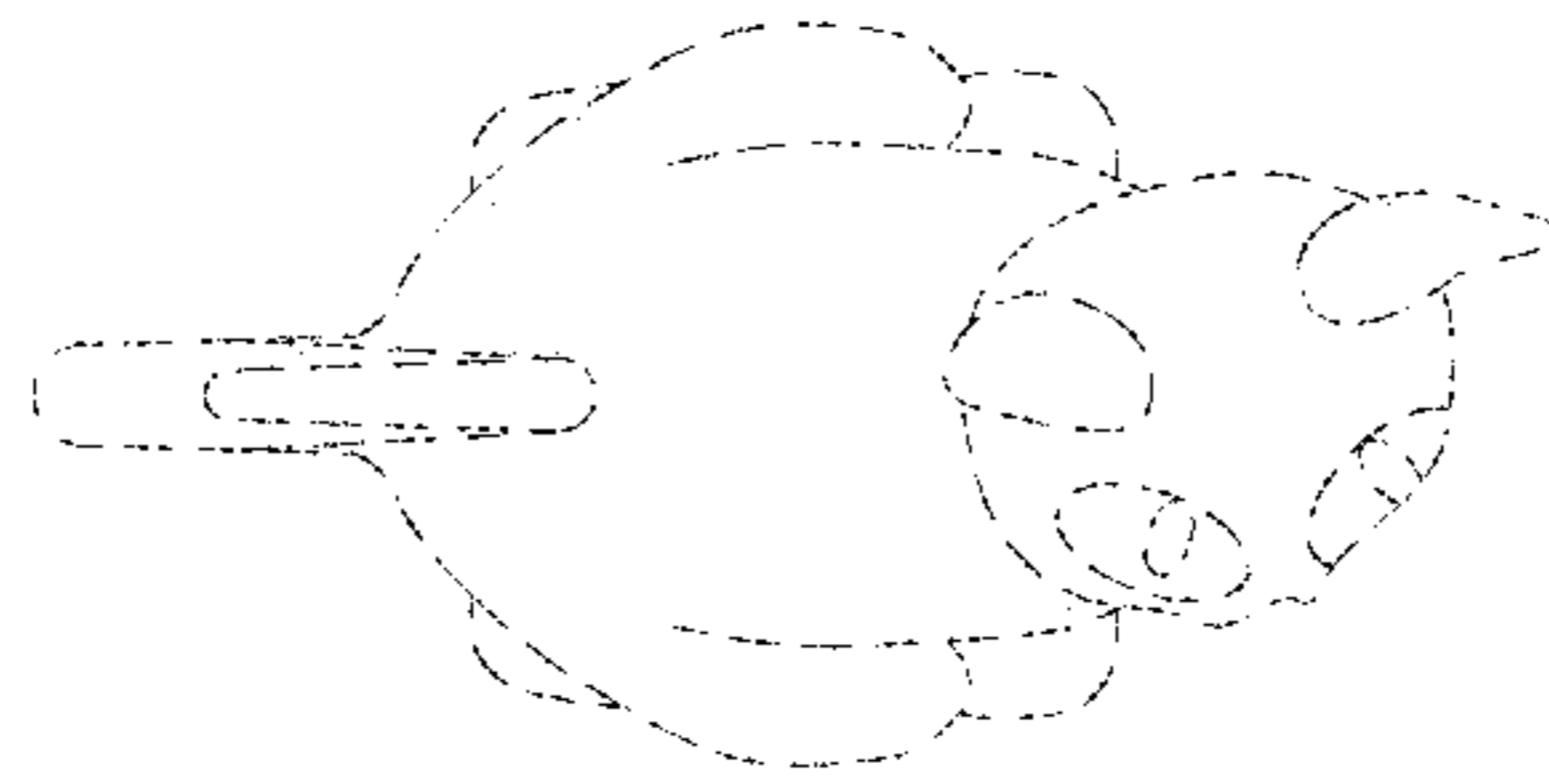

FIG. 32

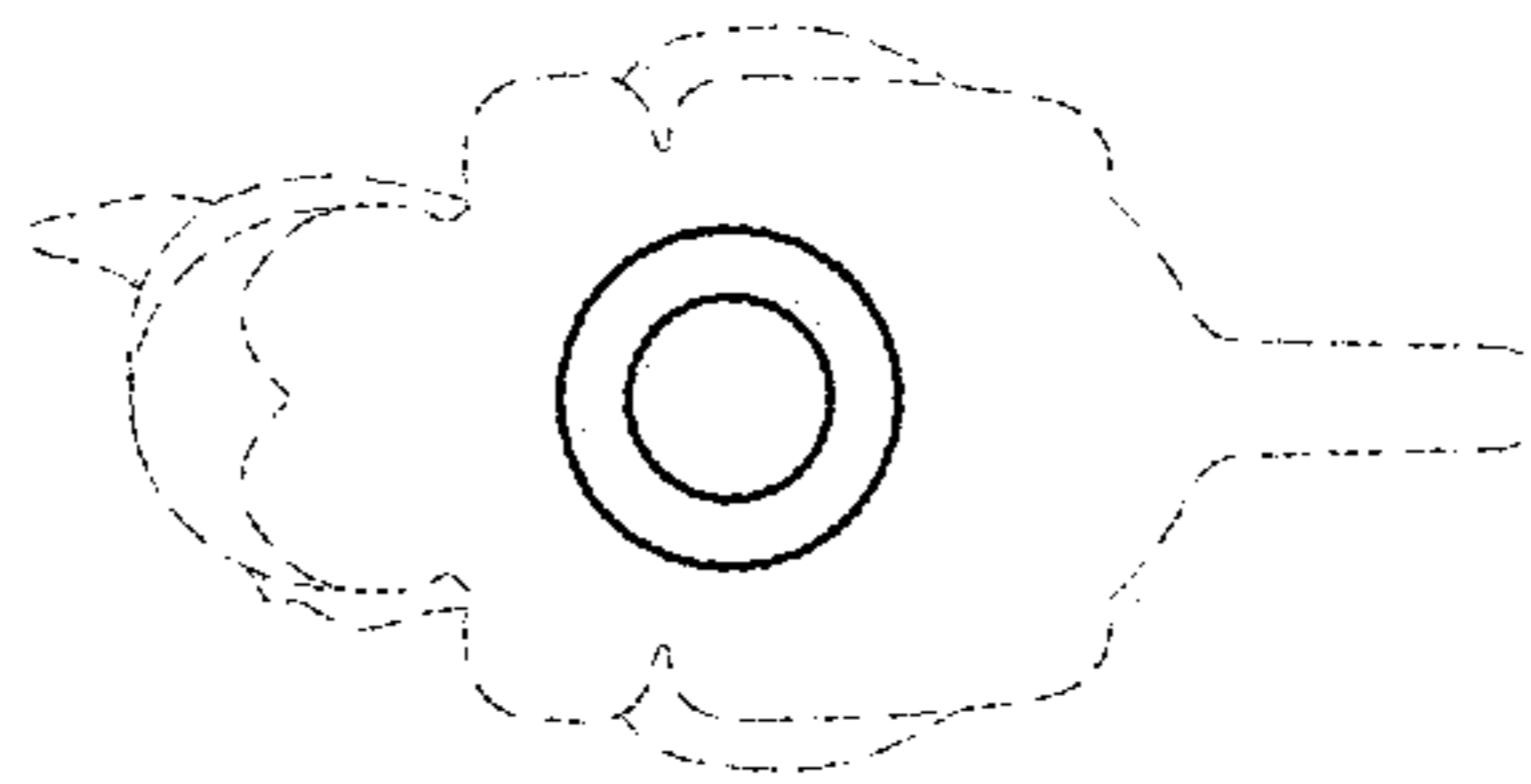

FIG. 33