



US00D910342S

(12) **United States Design Patent** (10) **Patent No.:** **US D910,342 S**  
**Li** (45) **Date of Patent:** **\*\* Feb. 16, 2021**

(54) **FOLDING DESK**  
(71) Applicant: **Gold Wing Trading Inc.**, Los Angeles, CA (US)  
(72) Inventor: **Qichao Li**, Foshan (CN)

D757,464 S 5/2016 Chiang  
D757,471 S 5/2016 Domingo  
D845,679 S \* 4/2019 Li ..... A47B 3/087  
D6/656  
D886,499 S \* 6/2020 Davis ..... D6/691.9  
D889,168 S \* 7/2020 Li ..... D6/656

(\*\*) Term: **15 Years**

(21) Appl. No.: **29/739,153**

(22) Filed: **Jun. 23, 2020**

(51) **LOC (13) Cl.** ..... **06-03**

(52) **U.S. Cl.**  
USPC ..... **D6/656**

(58) **Field of Classification Search**  
USPC ..... D6/641, 642, 656, 656.13, 656.14, D6/656.16, 685, 686, 691, 691.1–691.9  
CPC ..... A47B 7/00; A47B 13/00; A47B 13/02; A47B 13/04; A47B 13/06; A47B 13/08; A47B 13/12; A47B 17/00; A47B 17/003; A47B 17/006; A47B 21/00; A47B 2200/0001; A47B 2200/001; A47B 2200/0011; A47B 2200/0012; A47B 2200/002; A47B 2200/0066  
See application file for complete search history.

(56) **References Cited**

**U.S. PATENT DOCUMENTS**

3,187,693 A \* 6/1965 Hamilton ..... F16B 12/30  
108/157.13  
D220,704 S \* 5/1971 Kramer ..... D6/691.8  
D228,107 S \* 8/1973 Klotz et al. .... D6/691.6  
D244,114 S \* 4/1977 Neff ..... D6/691.8  
4,333,638 A \* 6/1982 Gillotti ..... A47B 3/087  
5/613  
D503,570 S \* 4/2005 Anderson ..... D6/349  
D575,083 S 8/2008 Lin  
D622,518 S 8/2010 Jordan  
D711,171 S 8/2014 Brielmaier

**OTHER PUBLICATIONS**

Sofsys Modern Folding Computer Writing Desk—Amazon.com, Date first available Jul. 1, 2020 [https://www.amazon.com/SOFSYS-Computer-Organization-Foldable-Industrial/dp/B088TB2QR8/ref=asc\\_df\\_B088TB2QR8/?tag=hyprod-20&linkCode=df0&hvadid=459663850453&hvpos=&hvnetw=g&hvrnd=1512](https://www.amazon.com/SOFSYS-Computer-Organization-Foldable-Industrial/dp/B088TB2QR8/ref=asc_df_B088TB2QR8/?tag=hyprod-20&linkCode=df0&hvadid=459663850453&hvpos=&hvnetw=g&hvrnd=1512) retrieved from the internet on Sep. 23, 2020.\*  
Willaurie Folding Desk, available at Wayfair—Decorist.com. <http://www.decorist.com/finds/213288/willaurie-foldijg-desk/> retrieved from the internet on Sep. 23, 2020.\*

\* cited by examiner

*Primary Examiner* — Mary Ann Calabrese  
(74) *Attorney, Agent, or Firm* — Rumit Ranjit Kanakia

(57) **CLAIM**

I claim the ornamental design for a folding desk, as shown and described.

**DESCRIPTION**

FIG. 1 is a Top Perspective view of a folding desk showing my new design;  
FIG. 2 is Bottom Perspective view thereof;  
FIG. 3 is a Front view thereof;  
FIG. 4 is a Back view thereof;  
FIG. 5 is a Right-side view thereof;  
FIG. 6 is a Left-side view thereof;  
FIG. 7 is a Top view thereof; and,  
FIG. 8 is a Bottom view thereof.  
The broken lines are for the purpose of illustrating portions of the article that form no part of the claim.

**1 Claim, 8 Drawing Sheets**

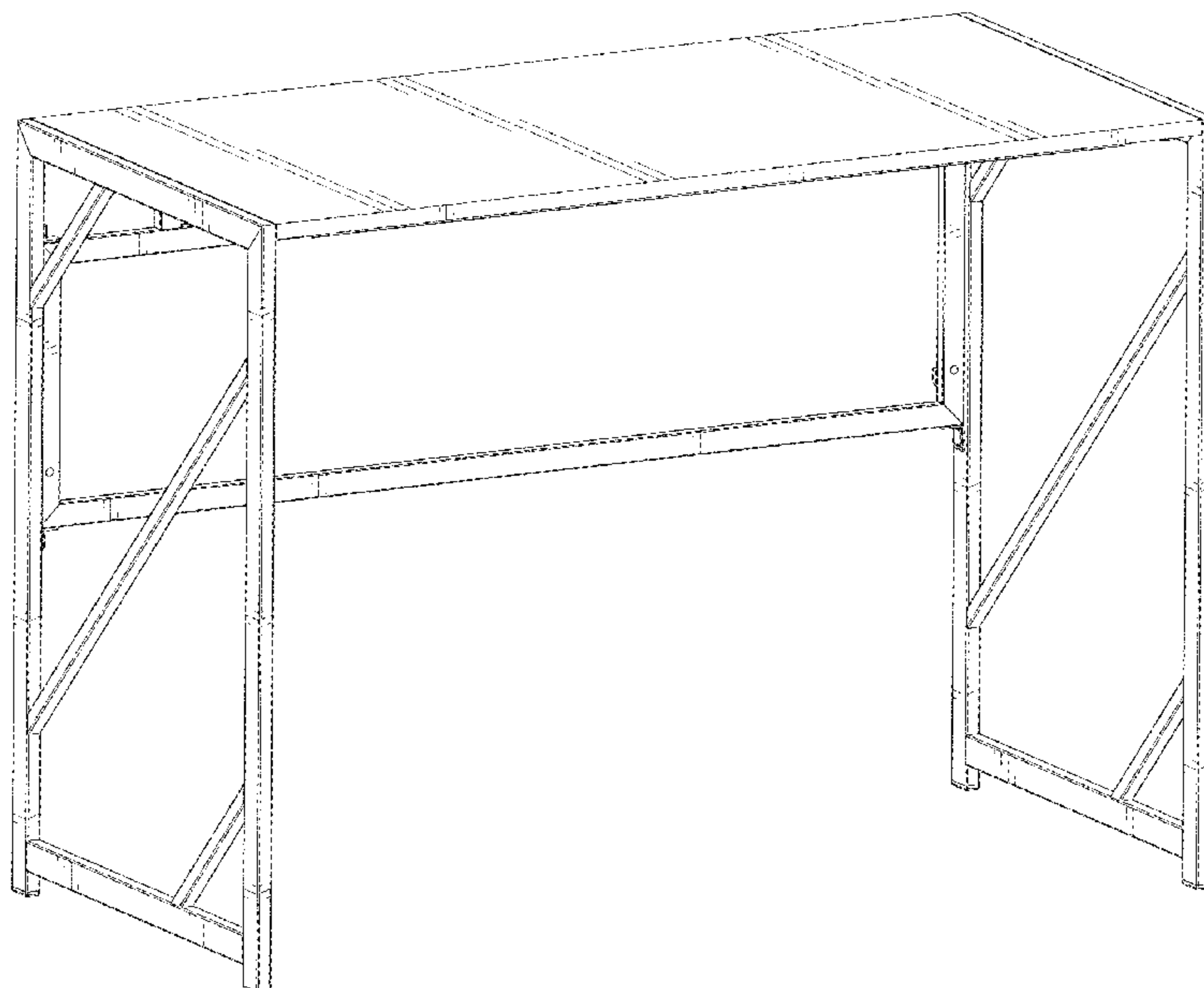

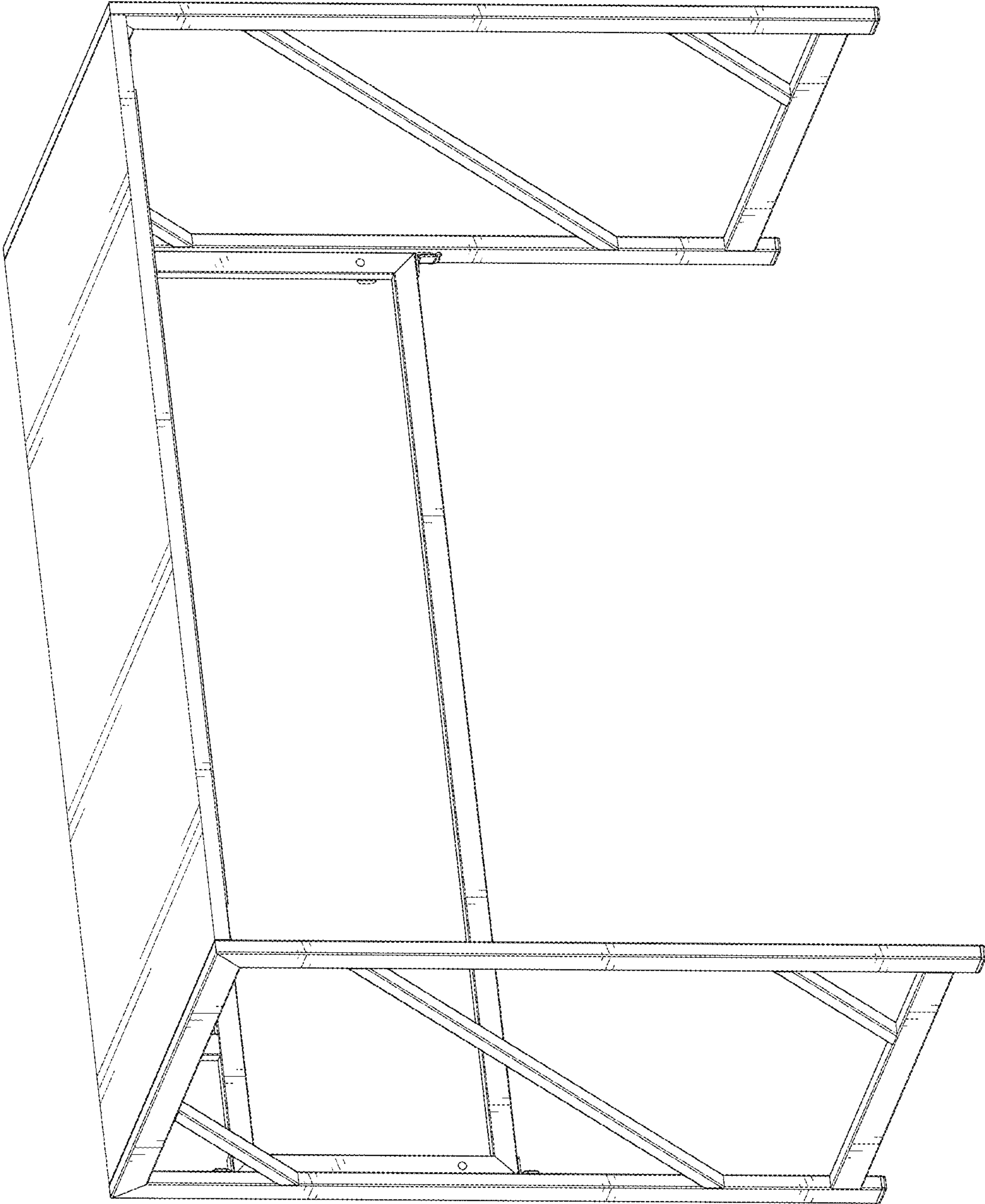

FIG. 1

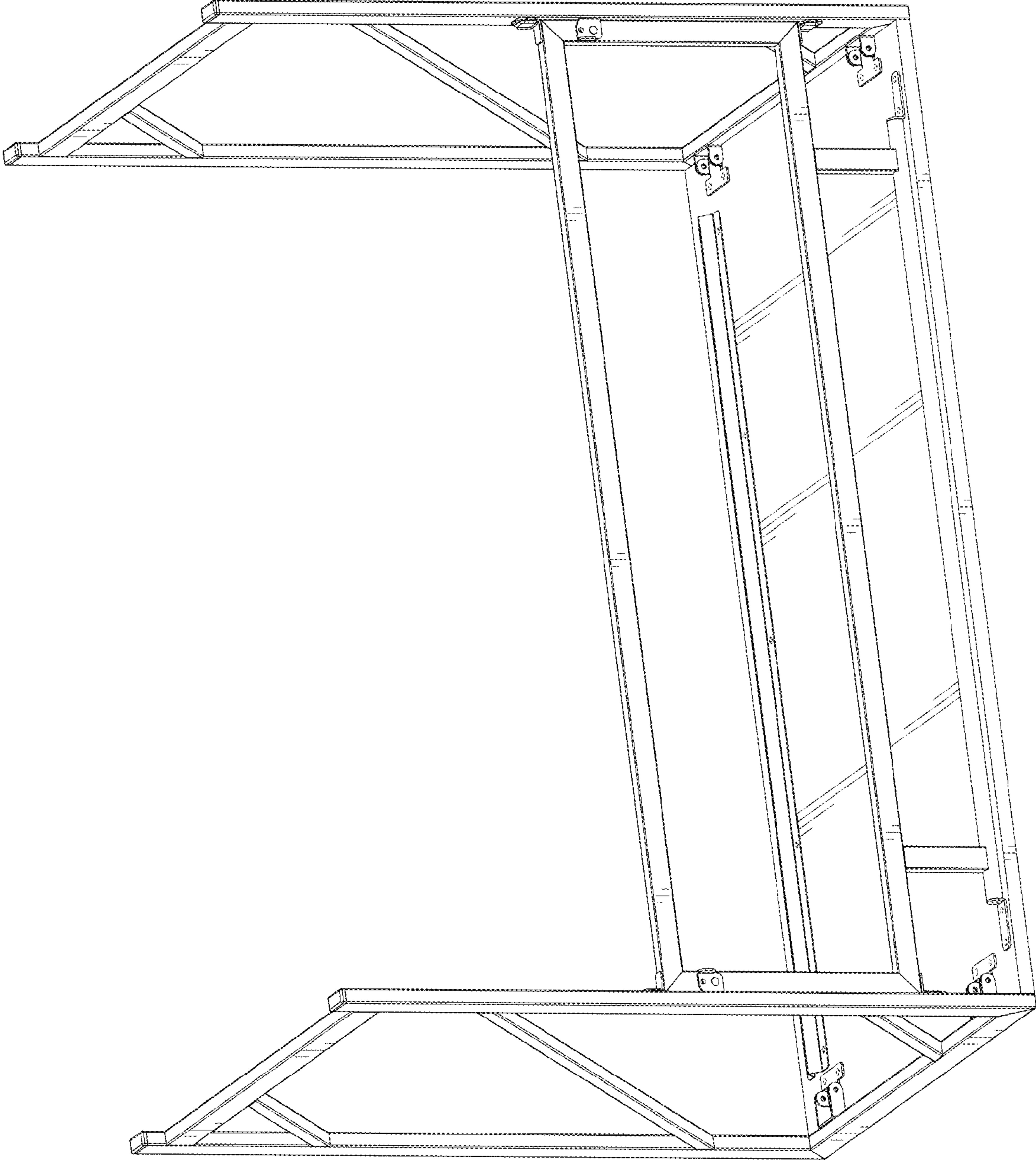

FIG. 2

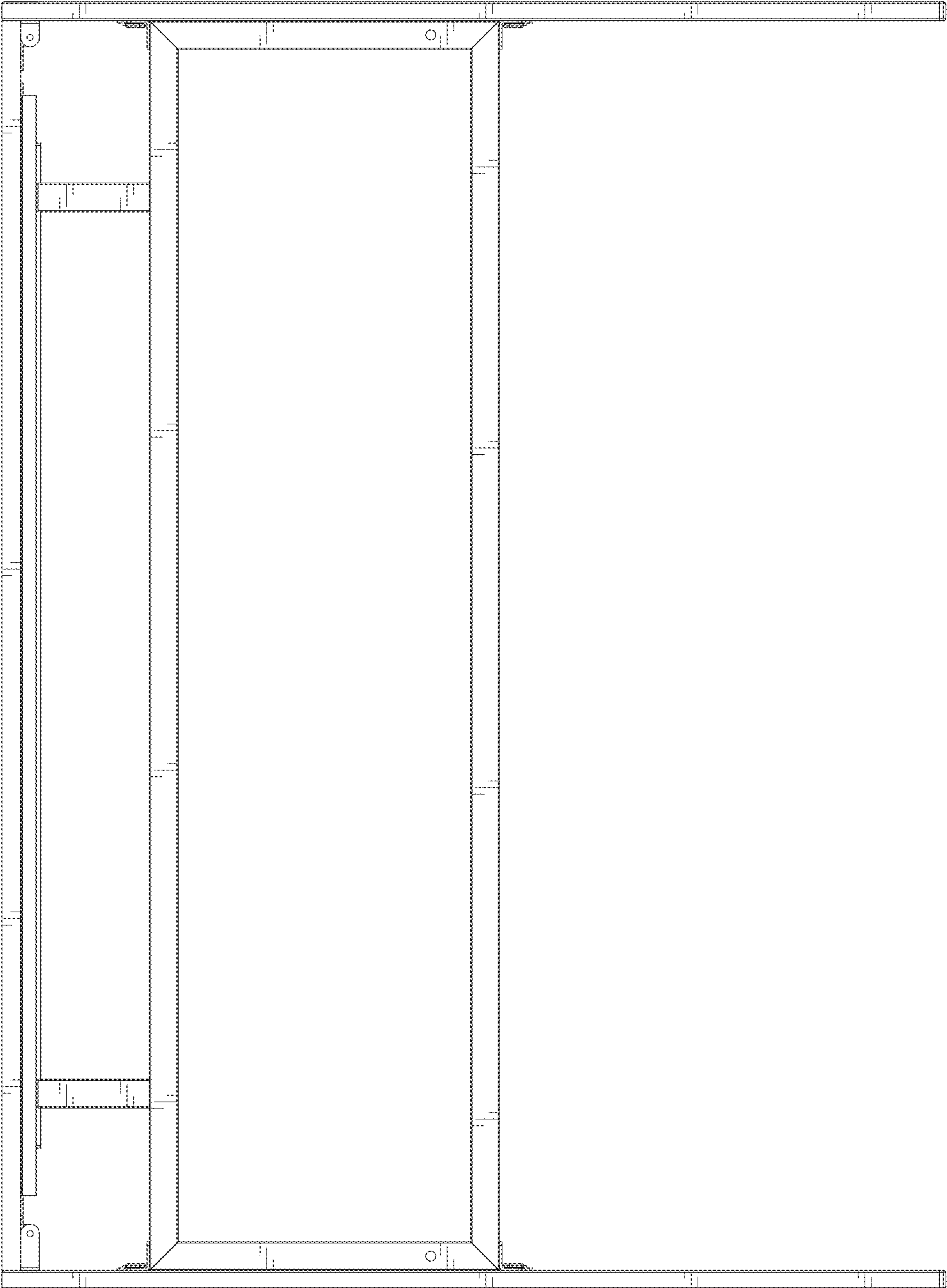

FIG. 3



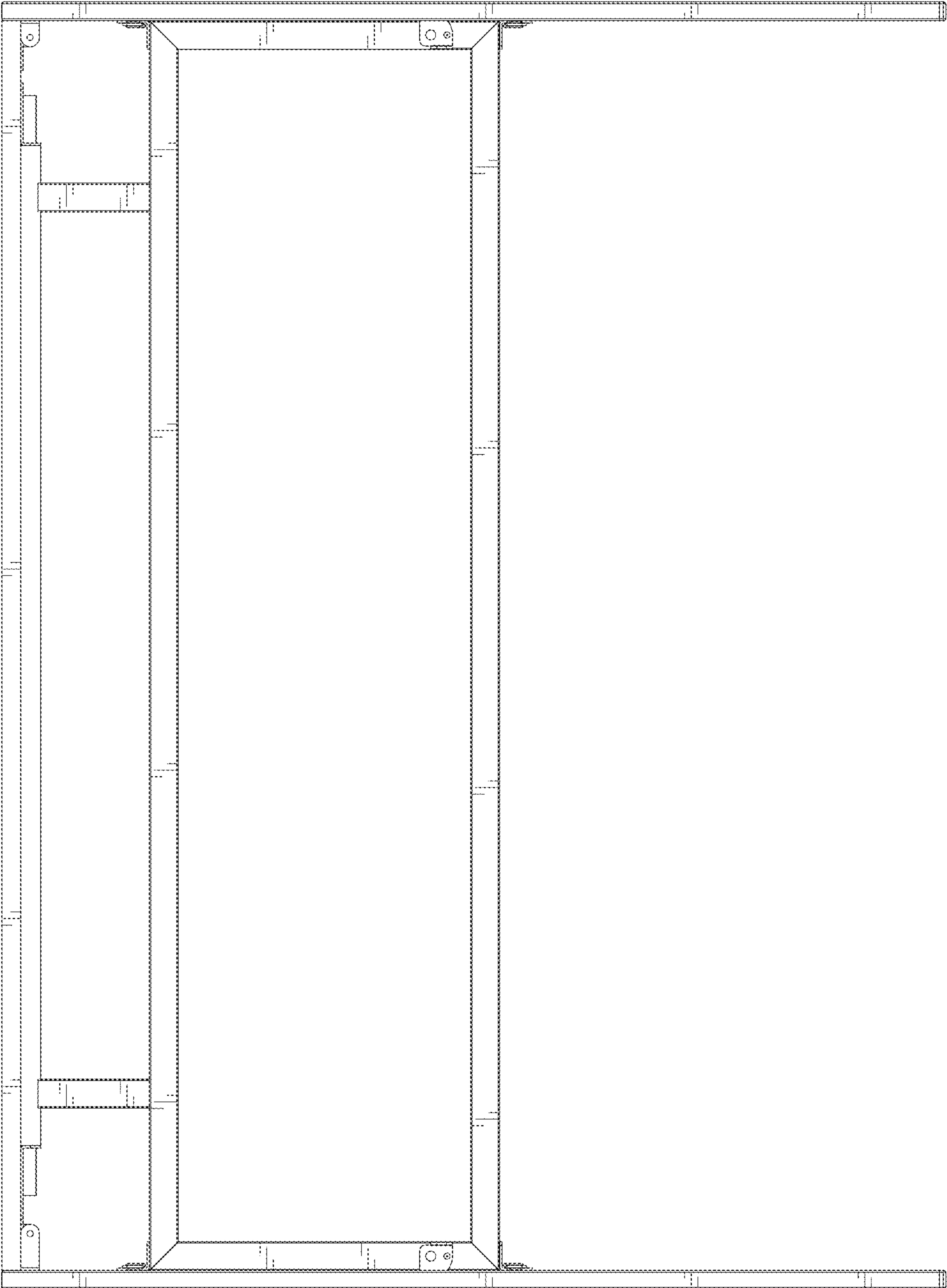

FIG. 4

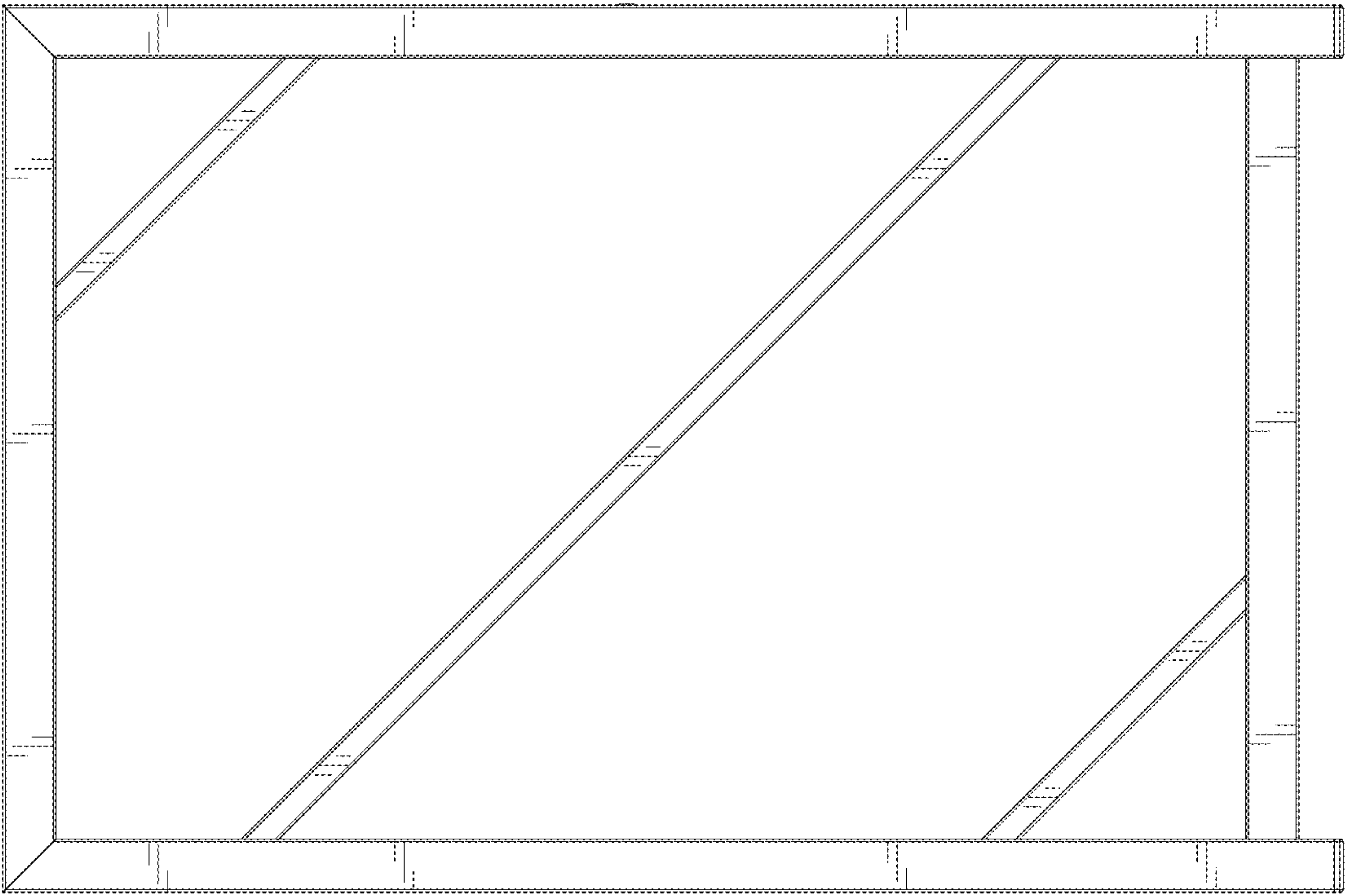

FIG. 5

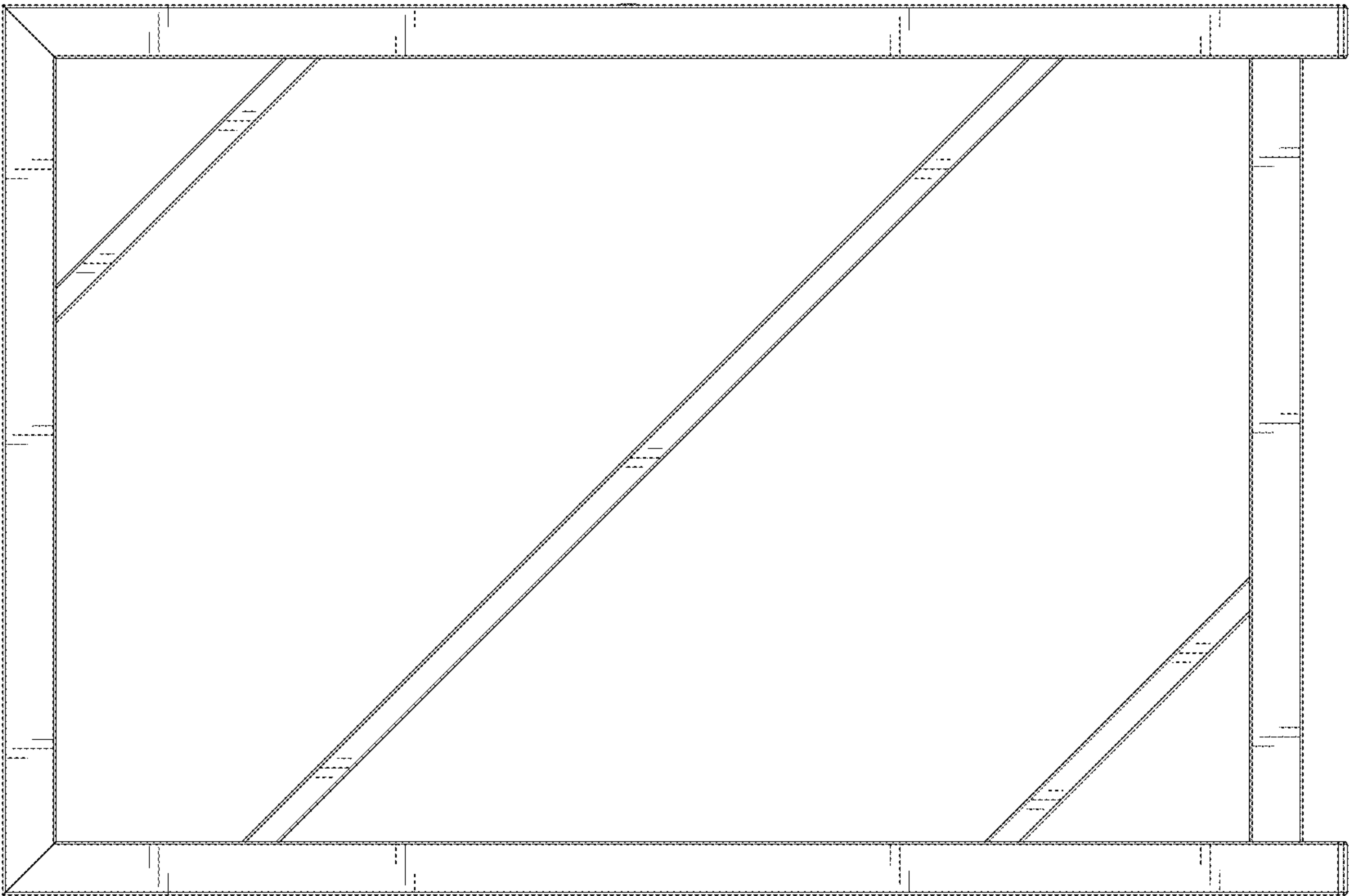

FIG. 6

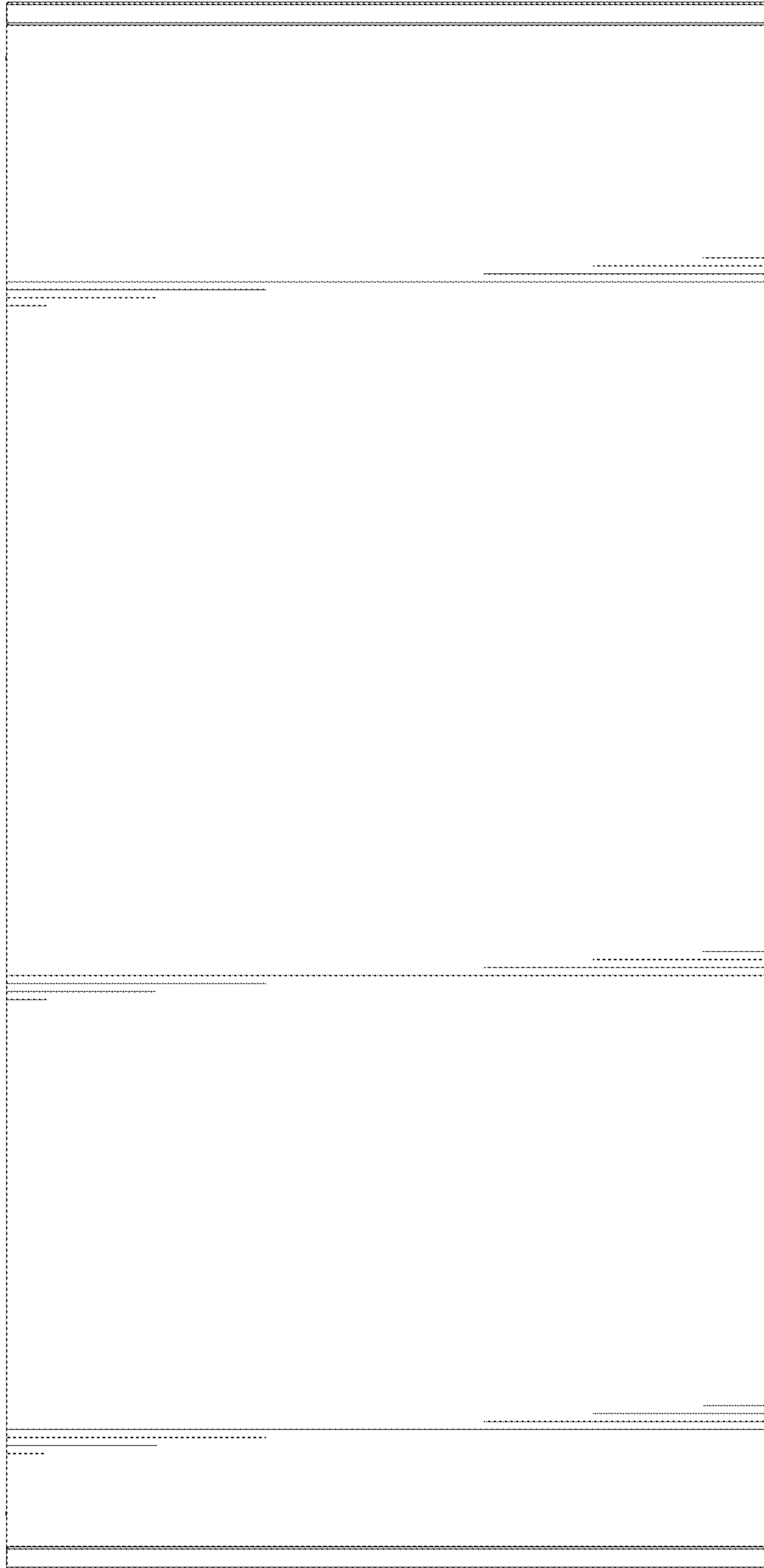

FIG. 7



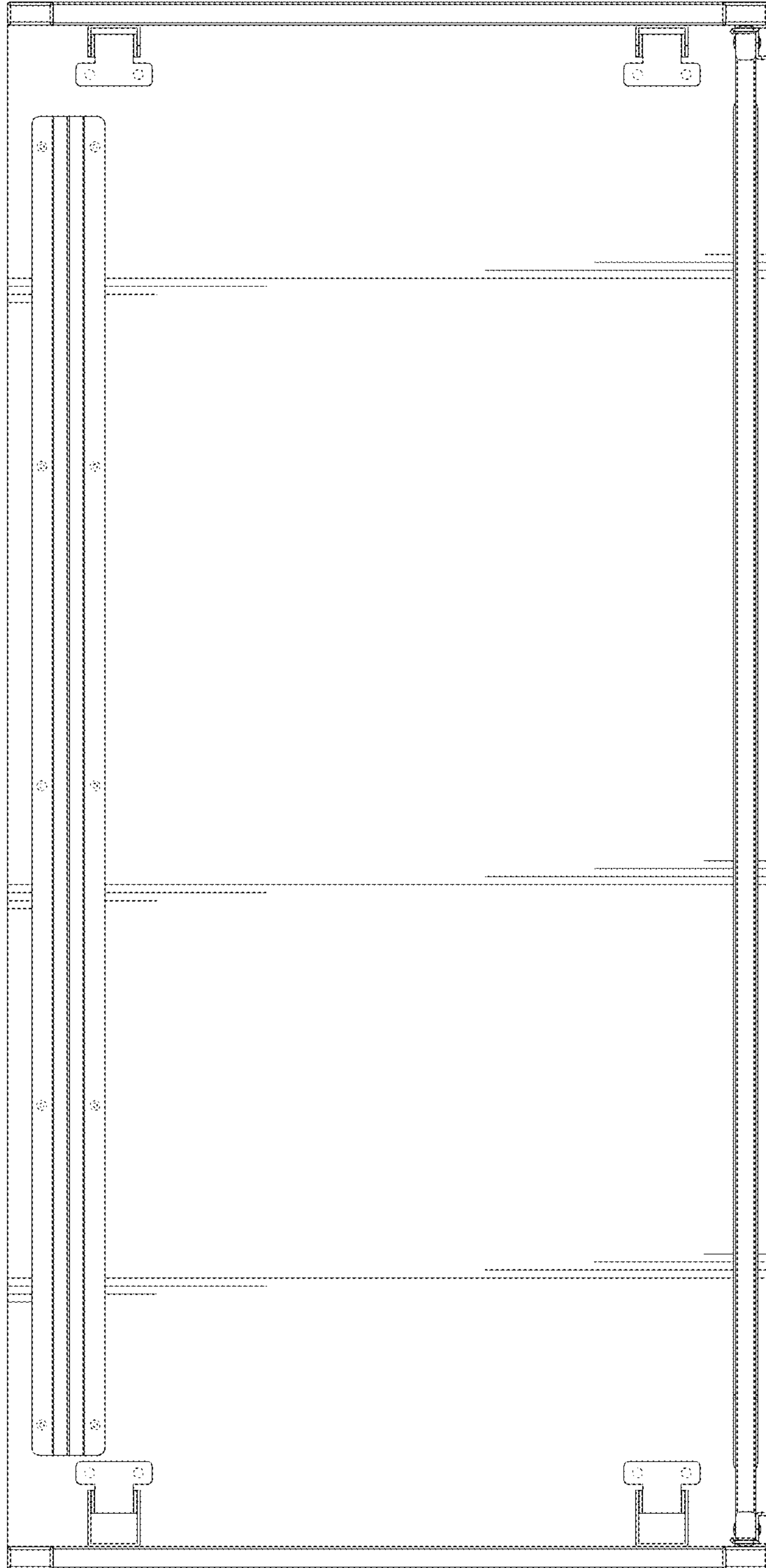

FIG. 8