



US00D910317S

(12) **United States Design Patent** (10) **Patent No.:** **US D910,317 S**
Aguiar et al. (45) **Date of Patent:** **** Feb. 16, 2021**

(54) **CLEANING BRUSH**
(71) Applicant: **The Libman Company**, Arcola, IL (US)
(72) Inventors: **Carlos Aguiar**, Arouca (PT); **Andrew D. Libman**, Arcola, IL (US); **Aaron Libman**, Arcola, IL (US); **Fernando de Jesus Santos**, Maceira Lra (PT)
(**) Term: **15 Years**

D575,518 S * 8/2008 Libman D4/129
D575,522 S * 8/2008 Libman D4/131
D575,523 S * 8/2008 Libman D4/132
D575,524 S * 8/2008 Libman D4/119
D575,525 S * 8/2008 Libman D4/118
D575,526 S * 8/2008 Libman D4/118
D575,527 S * 8/2008 Libman D4/134
D575,528 S * 8/2008 Libman D4/133
D575,529 S * 8/2008 Libman D4/128
D575,530 S * 8/2008 Libman D4/132
D577,204 S * 9/2008 Libman D4/129
D579,211 S * 10/2008 Libman D4/133
D580,657 S * 11/2008 Libman D4/129
D581,676 S * 12/2008 Libman D4/128

(21) Appl. No.: **35/507,981**

(Continued)

(22) Filed: **Nov. 28, 2018**

OTHER PUBLICATIONS

(80) **Hague Agreement Data**
Int. Filing Date: **Nov. 28, 2018**
Int. Reg. No.: **DM/204348**
Int. Reg. Date: **Nov. 28, 2018**
Int. Reg. Pub. Date: **Dec. 6, 2019**

“Libman Angled Toilet” found on Oct. 24, 2020 by RMS at https://www.burpy.com/kroger/libman-angeled-toilet-bowl-brush/product-detail/1309279.*

(Continued)

Primary Examiner — Rhea Shields

(51) **LOC (13) Cl.** **04-99**
(52) **U.S. Cl.**
USPC **D4/138**

(57) **CLAIM**

The ornamental design for a cleaning brush, as shown and described.

(58) **Field of Classification Search**
USPC D4/138, 131–134, 127–129, 119, 104; D8/107; D32/51, 41, 45
CPC A46B 5/0095; A47L 25/08; A47K 11/10
See application file for complete search history.

DESCRIPTION

- 1. Cleaning brush
- 1.1 : Perspective
- 1.2 : Right
- 1.3 : Left
- 1.4 : Back
- 1.5 : Front
- 1.6 : Top
- 1.7 : Bottom

The broken lines immediately adjacent to the photographic area define the bounds of the claimed design and form no part thereof; the broken lines showing the remainder of the cleaning tool represent unclaimed subject matter and form no part of the claimed design.

(56) **References Cited**
U.S. PATENT DOCUMENTS

D344,635 S * 3/1994 Berti D4/129
6,154,913 A * 12/2000 Burton A47K 11/10
15/160
D469,614 S * 2/2003 Libman D4/138
D492,119 S * 6/2004 Hay D4/127
D492,120 S * 6/2004 Hay D4/132
D500,926 S * 1/2005 Hay D4/138
D501,324 S * 2/2005 Berti D4/138
6,901,622 B2 * 6/2005 Thompson A47L 25/08
15/1.52

1 Claim, 7 Drawing Sheets

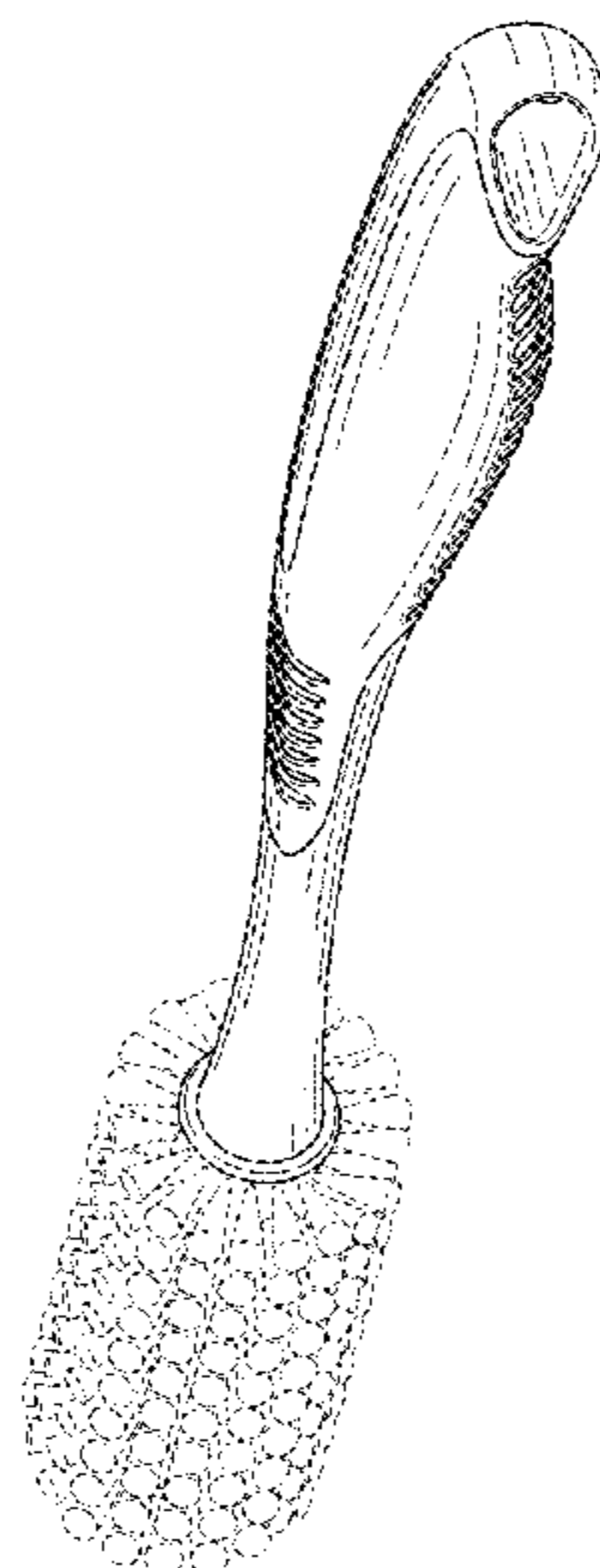

(56)

References Cited

U.S. PATENT DOCUMENTS

D584,060	S	*	1/2009	Hay	D4/134
D586,561	S	*	2/2009	Libman	D4/129
D588,767	S	*	3/2009	Libman	D32/41
7,555,802	B2	*	7/2009	Bohannon	A46B 5/0095
						15/111
D629,985	S	*	12/2010	Lee	D32/51
D630,021	S	*	1/2011	Libman	D4/138
D640,874	S	*	7/2011	Huang	D4/138
D697,315	S	*	1/2014	Schouten	D4/138
D759,384	S	*	6/2016	Libman	D4/138
D800,456	S	*	10/2017	Libman	D4/138
D834,827	S	*	12/2018	Hoffman	D4/104
D854,269	S	*	7/2019	Meier	D32/45
D889,242	S	*	7/2020	Jimenez	D8/107
2017/0251891	A1	*	9/2017	Libman	A46B 9/005

OTHER PUBLICATIONS

“Libman Scrub Kit” found on Oct. 24, 2020 by RMS at <https://www.amazon.com/Libman-Scrub-Brush-Green-White/dp/B07DFGDGVK>.*

* cited by examiner

1.1

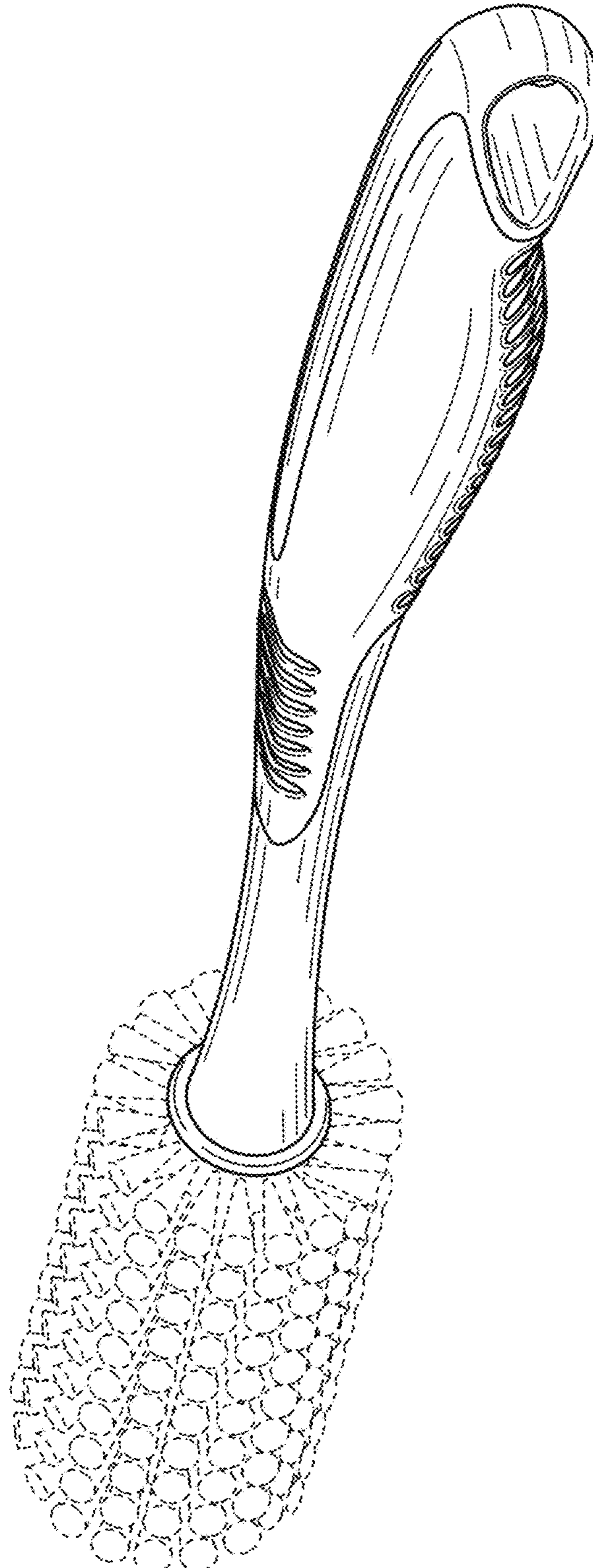

1.2

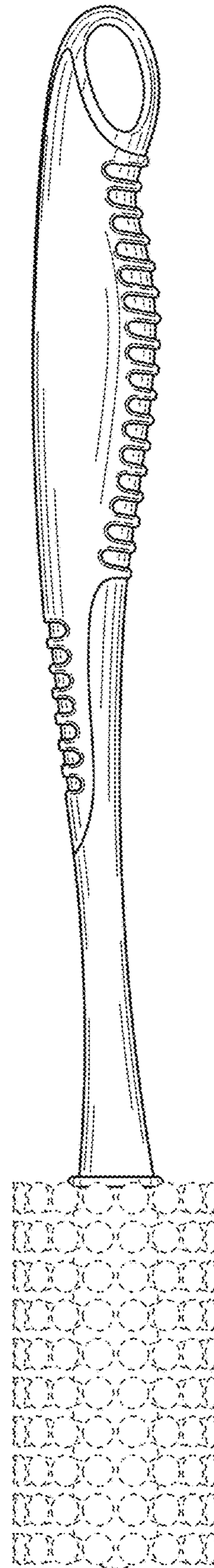

1.3

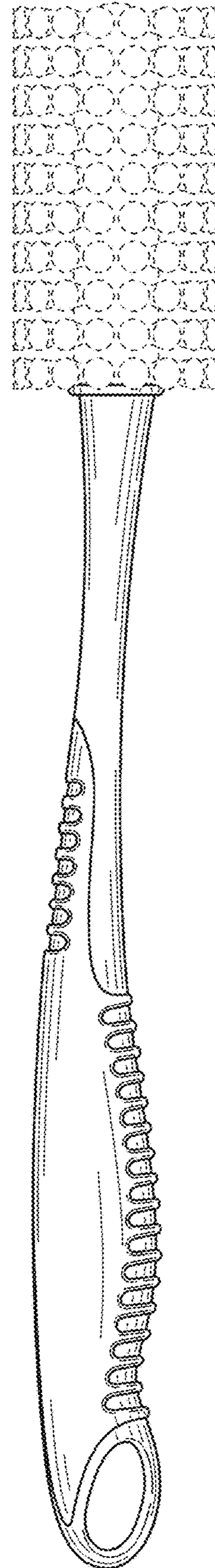

1.4

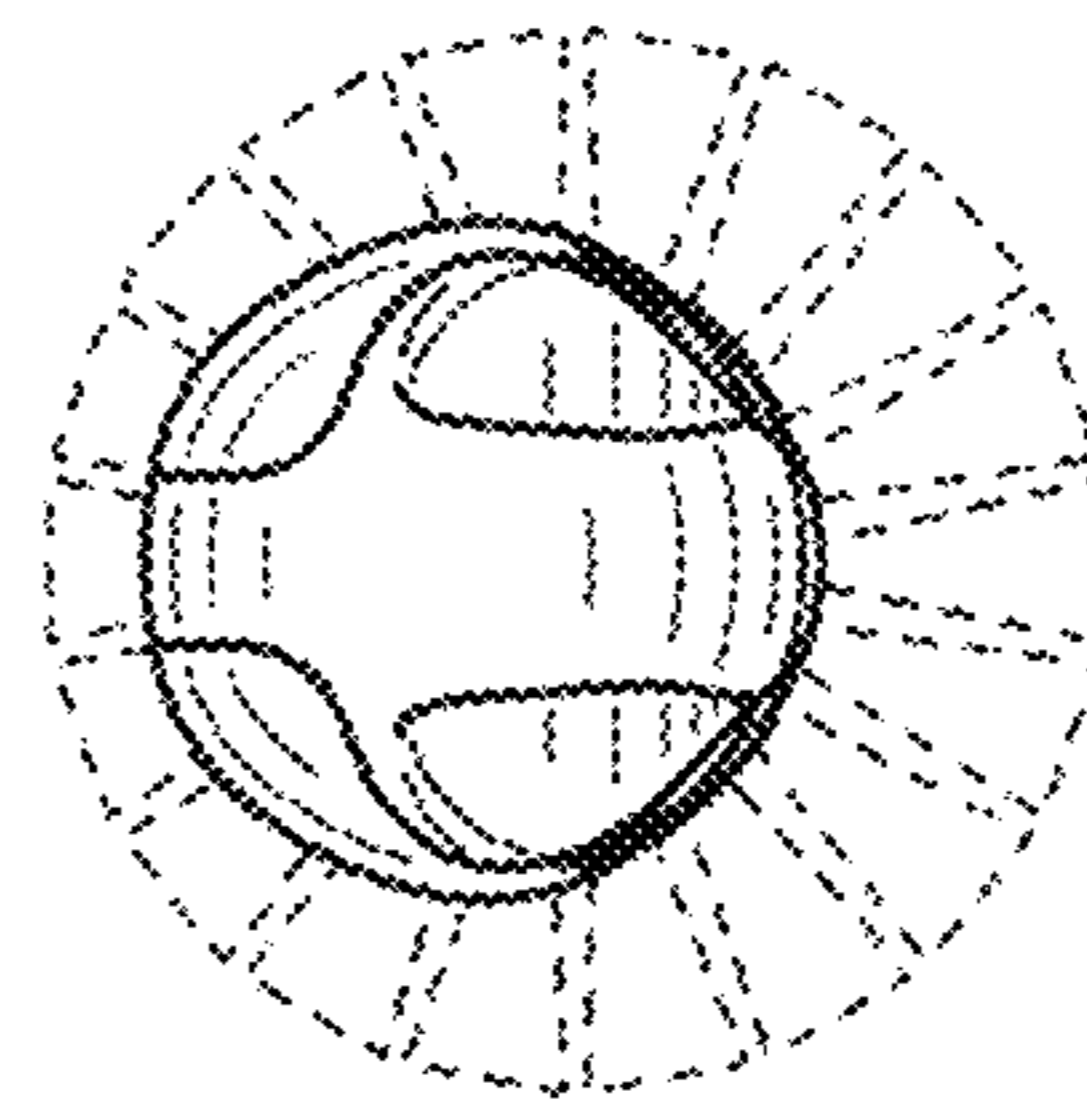

1.5

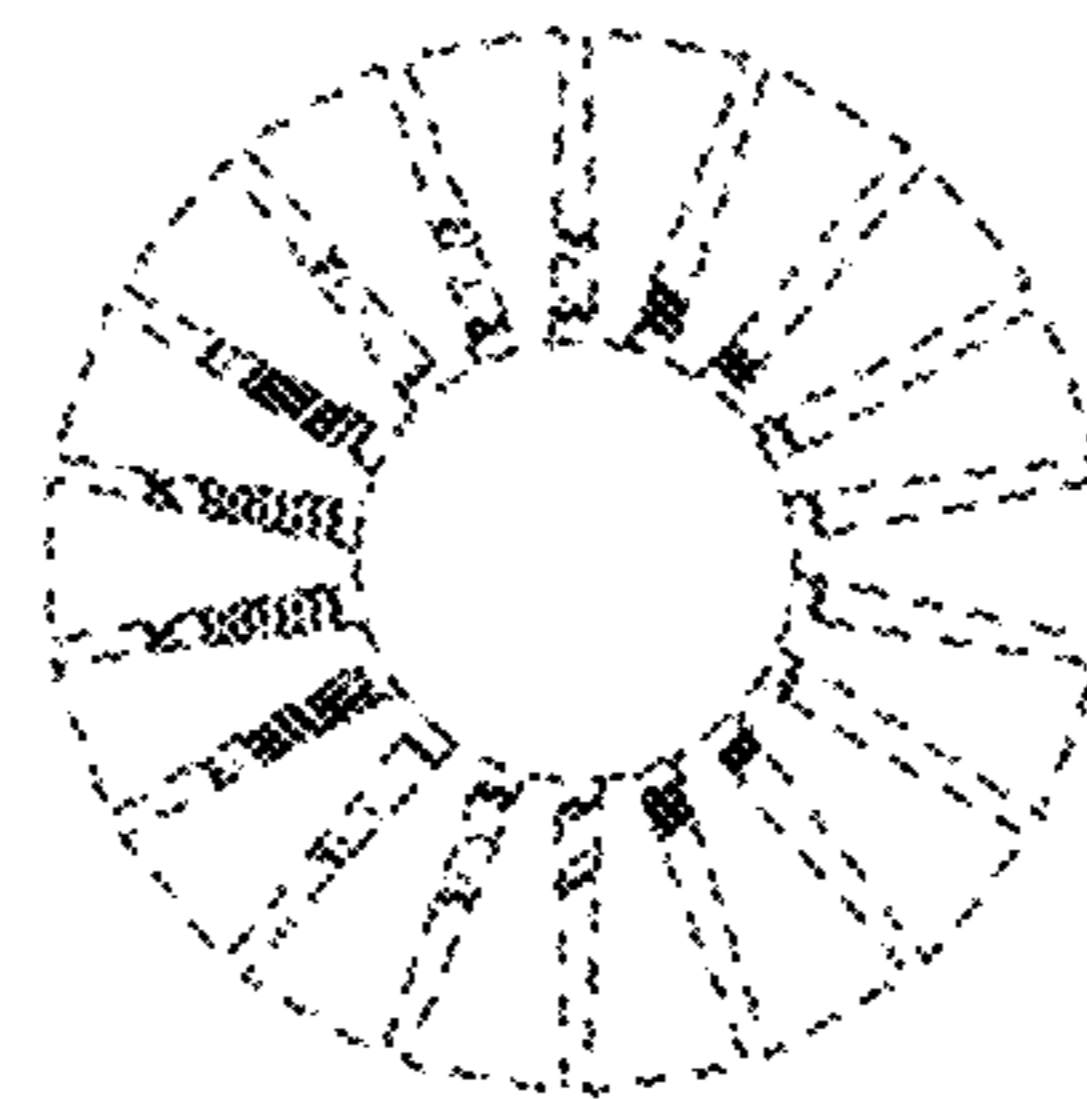

1.6

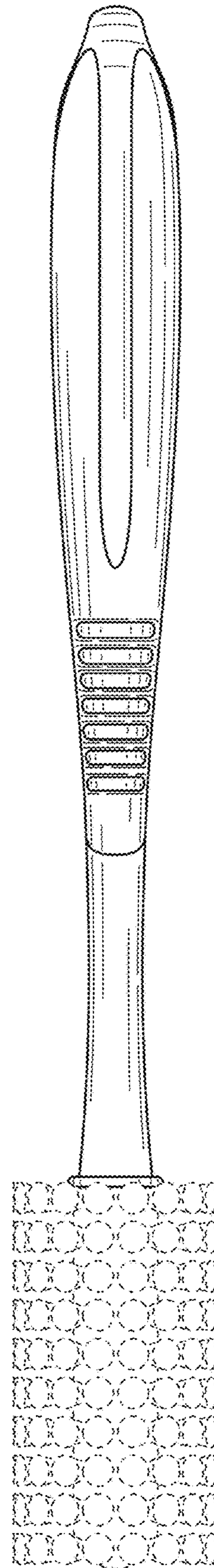

1.7

