



US00D910305S

(12) **United States Design Patent** (10) **Patent No.:** **US D910,305 S**  
**Gibson et al.** (45) **Date of Patent:** **\*\* Feb. 16, 2021**

(54) **BOOTIE PORTION OF A STOCKINGFOOT WADER**

(74) *Attorney, Agent, or Firm* — Antoinette M. Tease

(71) Applicant: **Simms Fishing Products LLC**,  
Bozeman, MT (US)

(57) **CLAIM**

The ornamental design for a bootie portion of a stockingfoot wader, as shown and described.

(72) Inventors: **Robert Gibson**, Bozeman, MT (US);  
**Derek Gustafson**, Bozeman, MT (US);  
**Simon Quay**, Portland, OR (US);  
**Jeremy Grodkiewicz**, Portland, OR (US)

**DESCRIPTION**

(73) Assignee: **Simms Fishing Products LLC**,  
Bozeman, MT (US)

FIG. 1 is a perspective view of the bootie portion of a stockingfoot wader showing the new design shown with the bootie attached to the rest of the wader.

(\*\*) Term: **15 Years**

FIG. 2 is a perspective view of the bootie portion of a stockingfoot wader showing the new design with the bootie standing alone.

(21) Appl. No.: **29/646,349**

FIG. 3 is a front view of the bootie portion of a stockingfoot wader showing the new design with the bootie standing alone.

(22) Filed: **May 3, 2018**

FIG. 4 is a rear view of the bootie portion of a stockingfoot wader showing the new design with the bootie standing alone.

**Related U.S. Application Data**

FIG. 5 is a first side view of the bootie portion of a stockingfoot wader showing the new design with the bootie standing alone.

(63) Continuation-in-part of application No. 29/642,501,  
filed on Mar. 29, 2018, now abandoned.

FIG. 6 is a second side view of the bootie portion of a stockingfoot wader showing the new design with the bootie standing alone.

(51) **LOC (13) Cl.** ..... **02-04**

(52) **U.S. Cl.**  
USPC ..... **D2/980**; D2/983; D2/994

FIG. 7 is a top view of the bootie portion of a stockingfoot wader showing the new design with the bootie standing alone.

(58) **Field of Classification Search**  
USPC ..... D2/896, 901–903, 905, 909–911, 919,  
D2/946–947, 951, 960, 970, 980, 983,  
D2/985–987, 991, 994; D21/680, 681  
(Continued)

FIG. 8 is a bottom view of the bootie portion of a stockingfoot wader showing the new design with the bootie standing alone.

(56) **References Cited**

**U.S. PATENT DOCUMENTS**

757,424 A 4/1904 Vohi  
3,128,566 A 4/1964 Burlison et al.  
(Continued)

FIG. 9 is a perspective view of the bootie portion of a stockingfoot wader showing the new design with the bootie standing alone and turned inside out.

FIG. 10 is a front view of the bootie portion of a stockingfoot wader showing the new design with the bootie standing alone and turned inside out.

FIG. 11 is a rear view of the bootie portion of a stockingfoot wader showing the new design with the bootie standing alone and turned inside out.

(Continued)

*Primary Examiner* — Michael C Stout  
*Assistant Examiner* — Melvin L Davis

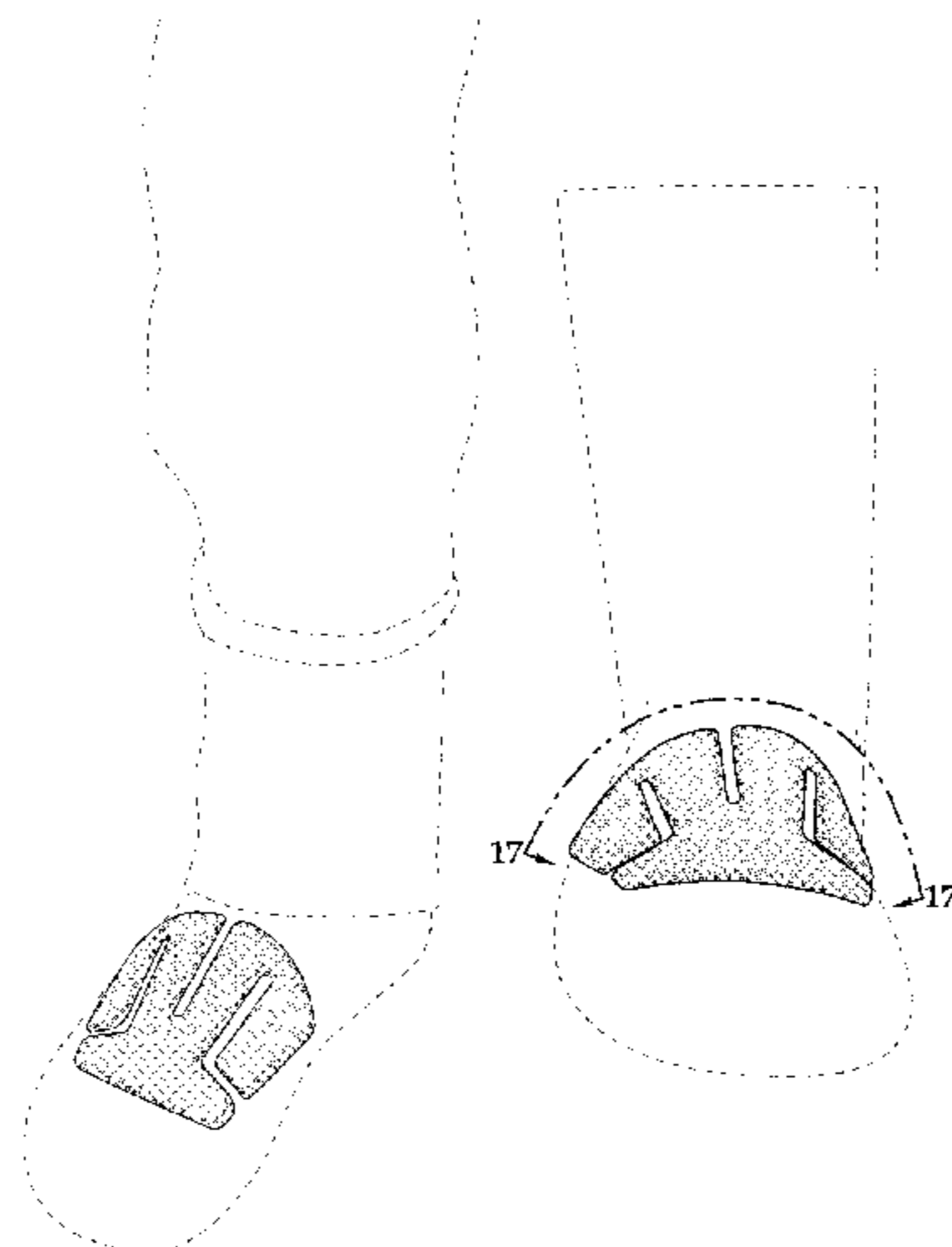

FIG. 12 is a top view of the bootie portion of a stockingfoot wader showing the new design with the bootie standing alone and turned inside out.

FIG. 13 is a bottom view of the bootie portion of a stockingfoot wader showing the new design with the bootie standing alone and turned inside out.

FIG. 14 is a first side view of the bootie portion of a stockingfoot wader showing the new design with the bootie standing alone and turned inside out.

FIG. 15 is a second side view of the bootie portion of a stockingfoot wader showing the new design with the bootie standing alone and turned inside out.

FIG. 16 is a panoramic (or pattern) view of the inside of the bootie portion of a stockingfoot wader showing the new design. This view is taken from the perspective shown by the indicator line in FIG. 7; and,

FIG. 17 is a pattern view of the outside of the bootie portion of a stockingfoot wader showing the new design. This view is taken from the perspective shown by the indicator line in FIG. 3.

The showing of broken lines are included for the purpose of illustrating environmental structure and forms no part of the claimed design.

**1 Claim, 7 Drawing Sheets**

(58) **Field of Classification Search**

CPC ..... A43B 3/00  
See application file for complete search history.

(56)

**References Cited**

U.S. PATENT DOCUMENTS

5,022,096	A *	6/1991	Pacanowsky .....	A41D 27/24 2/227
D319,917	S *	9/1991	Mishima .....	D2/903
D337,195	S *	7/1993	Vick .....	D2/911
5,295,312	A	3/1994	Blumberg et al.	
5,319,807	A	6/1994	Brier	
5,353,524	A	10/1994	Brier	
5,499,459	A	3/1996	Tomaro	
D380,592	S *	7/1997	Whittington .....	D2/910
5,708,985	A	1/1998	Ogden	
6,286,151	B1	9/2001	Lambertz	
D478,718	S *	8/2003	Northcraft .....	D2/980
7,392,601	B2	7/2008	Vattes et al.	
D600,438	S *	9/2009	Edy .....	D2/980
D618,889	S *	7/2010	Jones .....	D2/909
8,146,266	B2	4/2012	Vattes et al.	
8,191,284	B2	6/2012	Cho	
8,359,769	B2	1/2013	Vattes et al.	
D722,422	S *	2/2015	Solsona .....	D2/910
9,226,527	B2	1/2016	Dahlgren et al.	
D778,549	S *	2/2017	Conklin .....	D2/903
D825,145	S *	8/2018	Fowler .....	D2/743
D869,840	S *	12/2019	Chaney .....	D2/980
D870,420	S *	12/2019	Beernink .....	D2/743
2006/0143801	A1	7/2006	Lambertz	
2006/0277785	A1	12/2006	Vattes et al.	
2006/0277786	A1	12/2006	Vattes et al.	
2006/0277787	A1	12/2006	Vattes et al.	
2011/0099855	A1	5/2011	Cho	
2014/0157491	A1	6/2014	Dahlgren	
2015/0047103	A1	2/2015	Dahlgren et al.	

\* cited by examiner

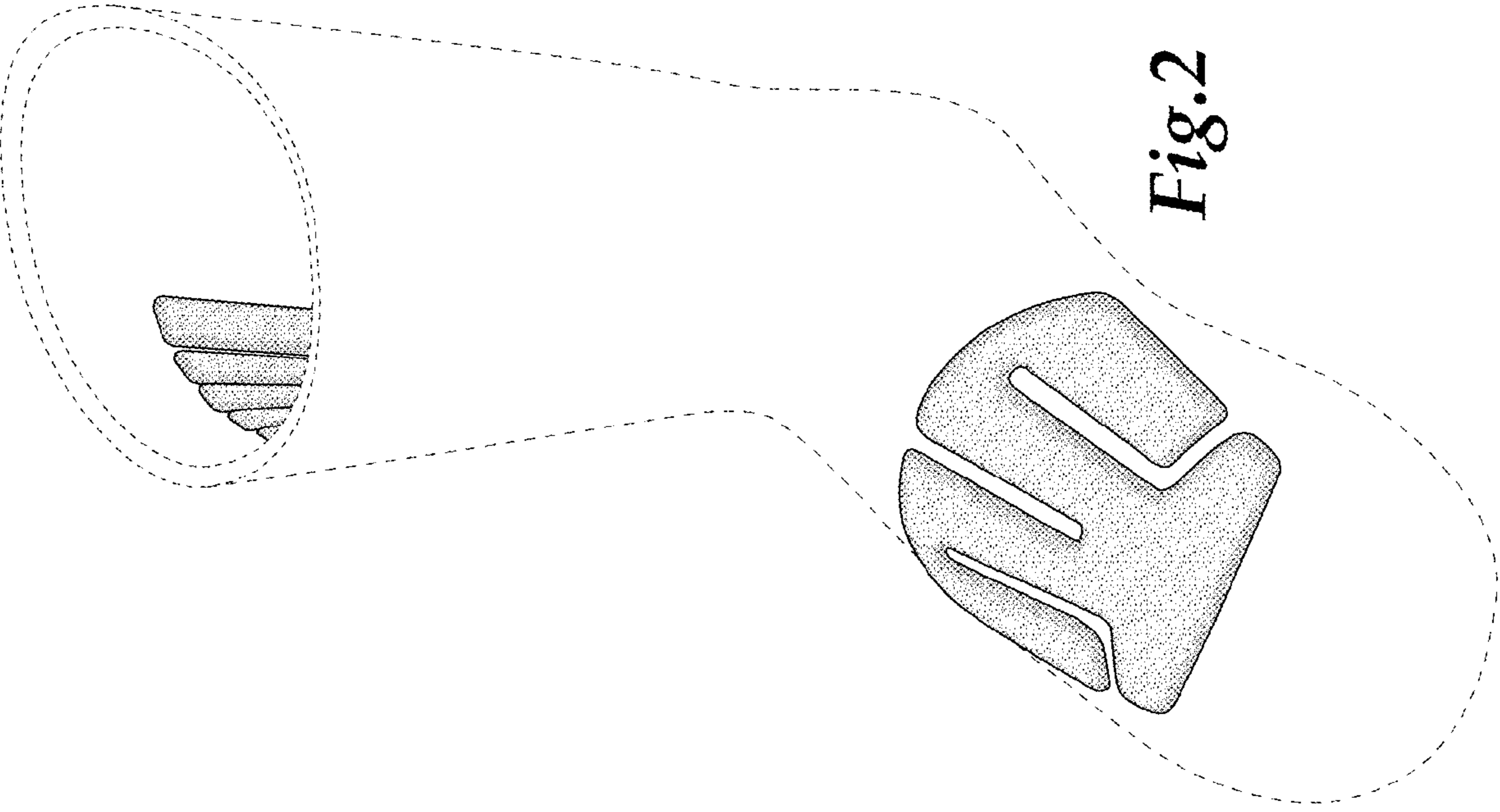

Fig. 2

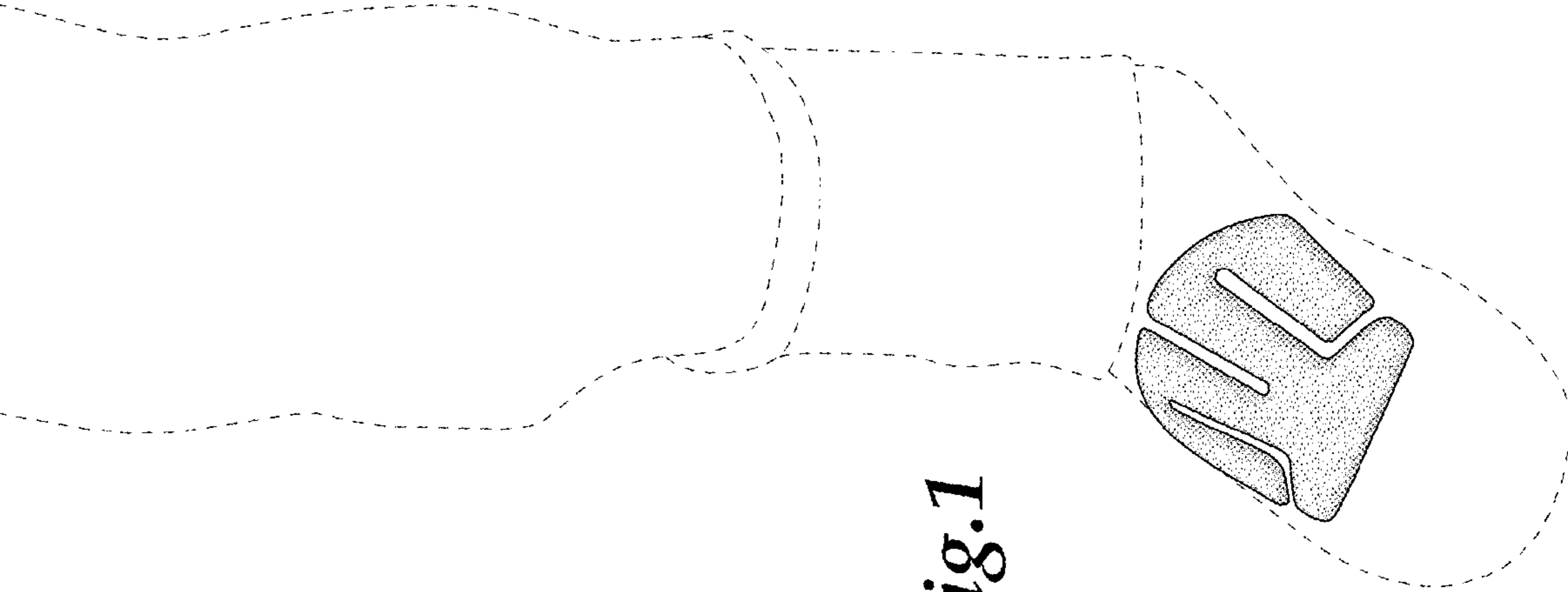

Fig. 1

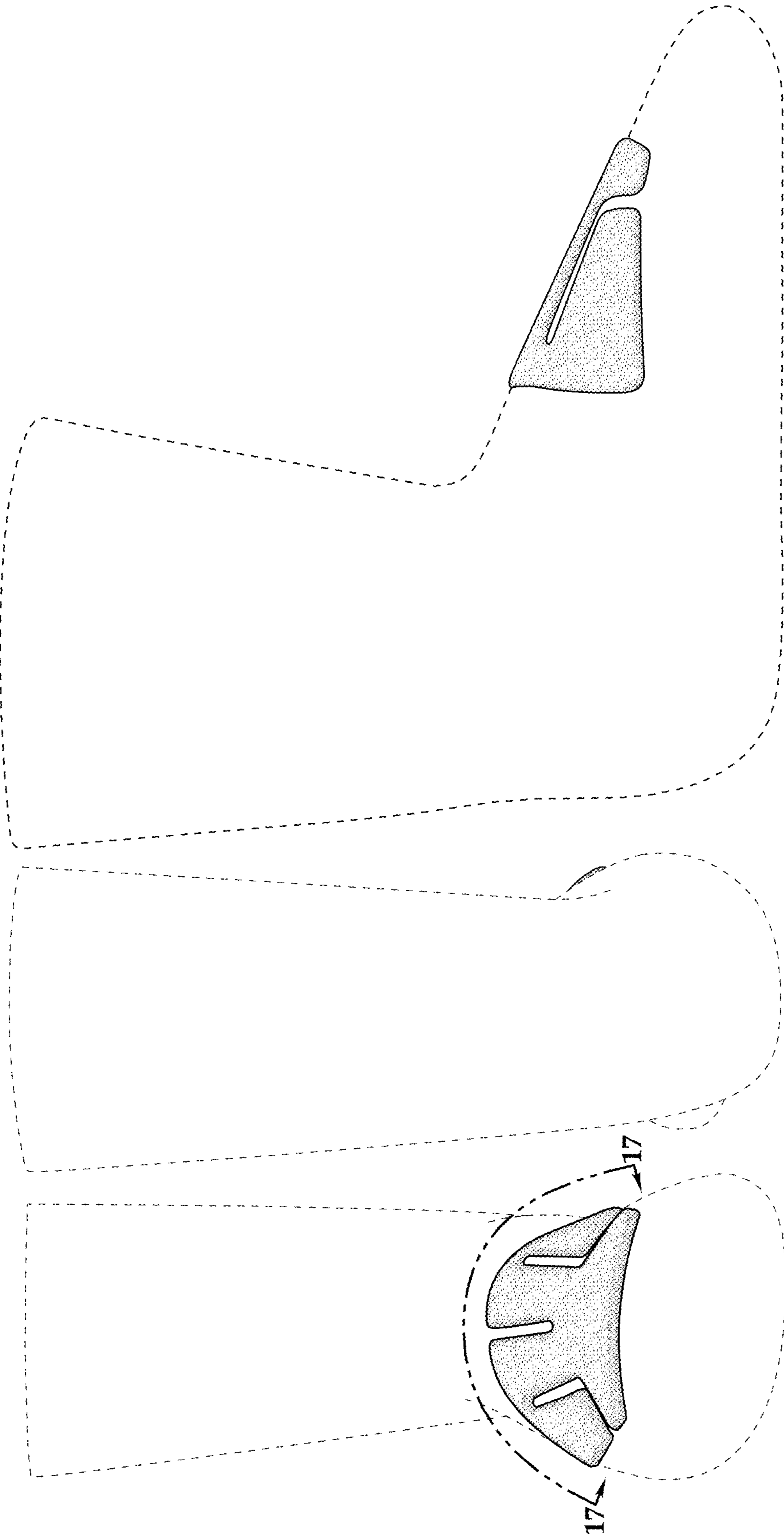

Fig.5

Fig.4

Fig.3

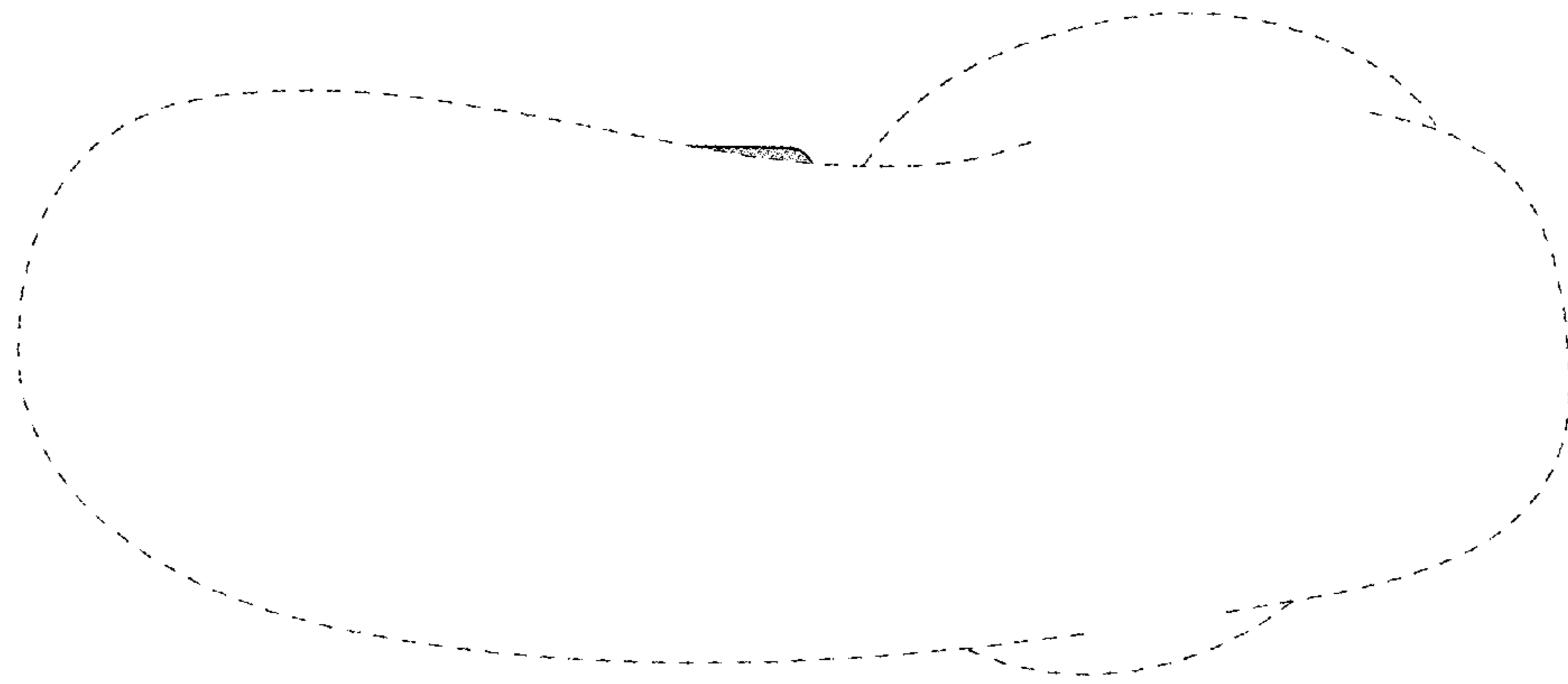

Fig. 8

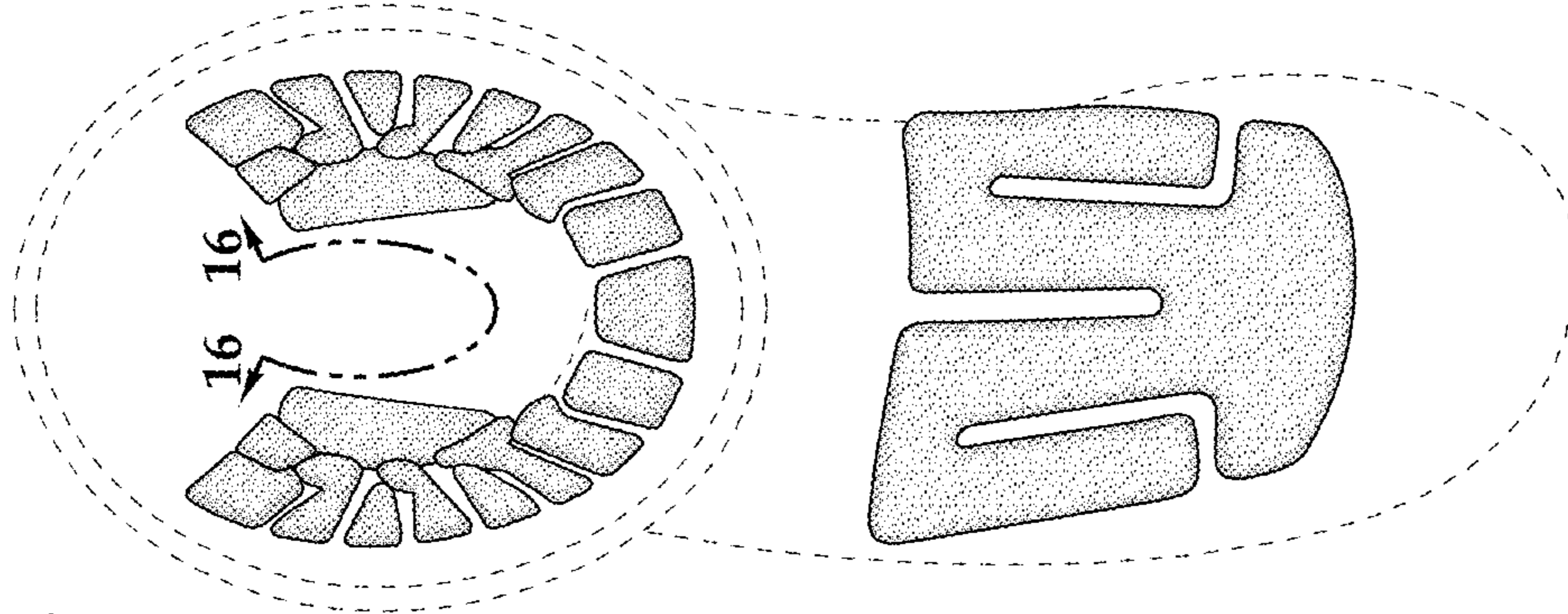

Fig. 7

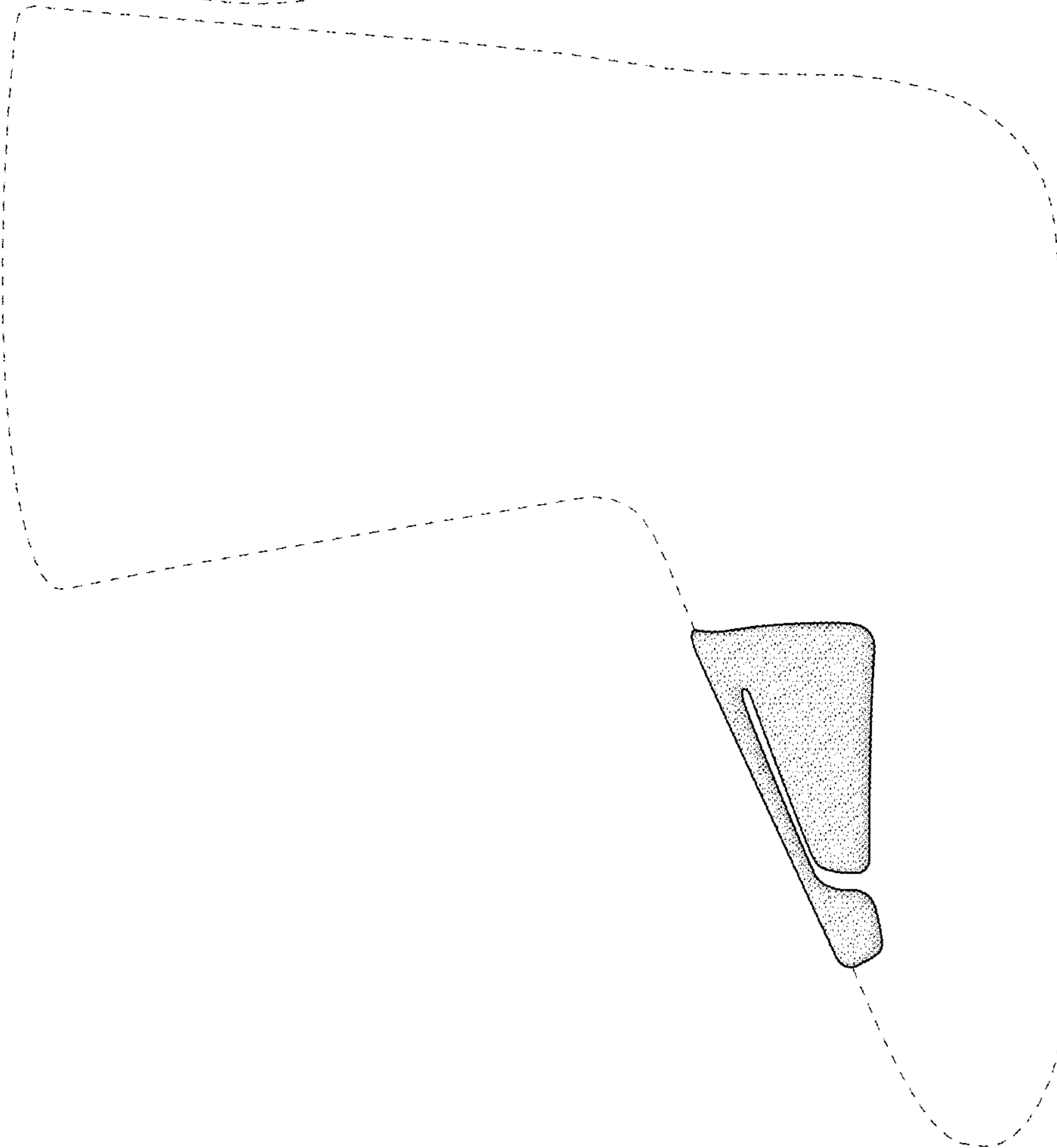
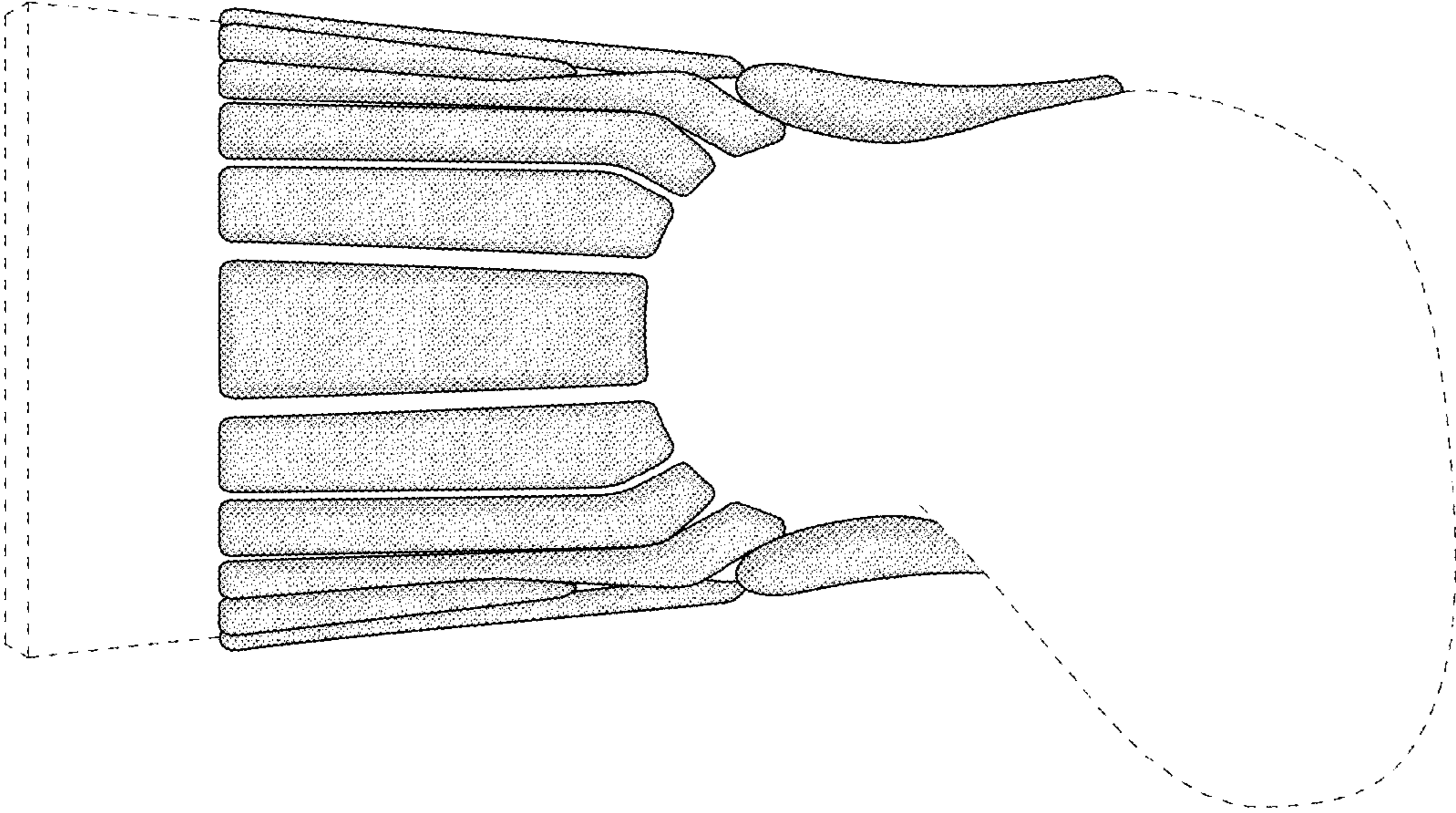
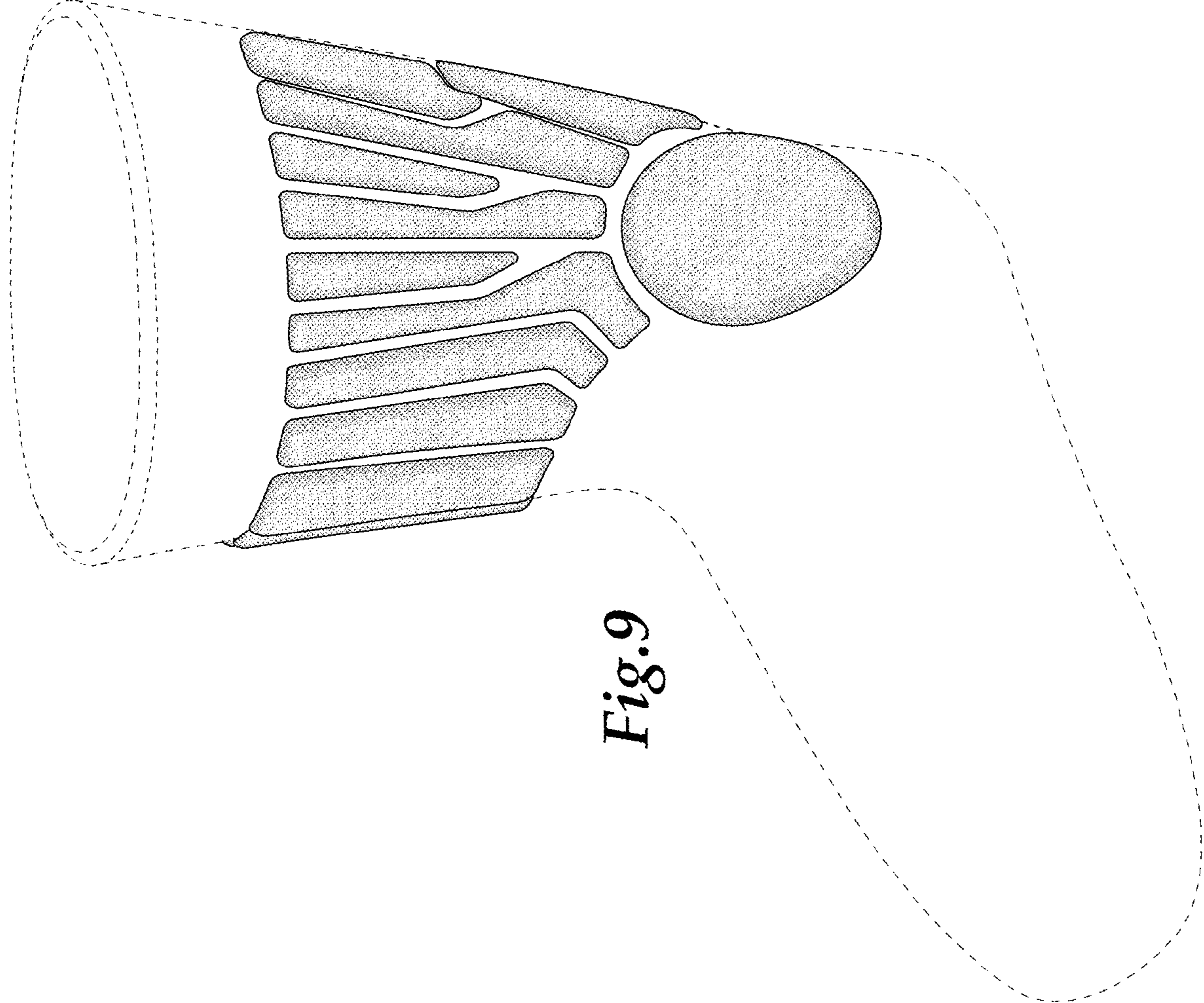

Fig. 6



*Fig. 9*



*Fig. 10*

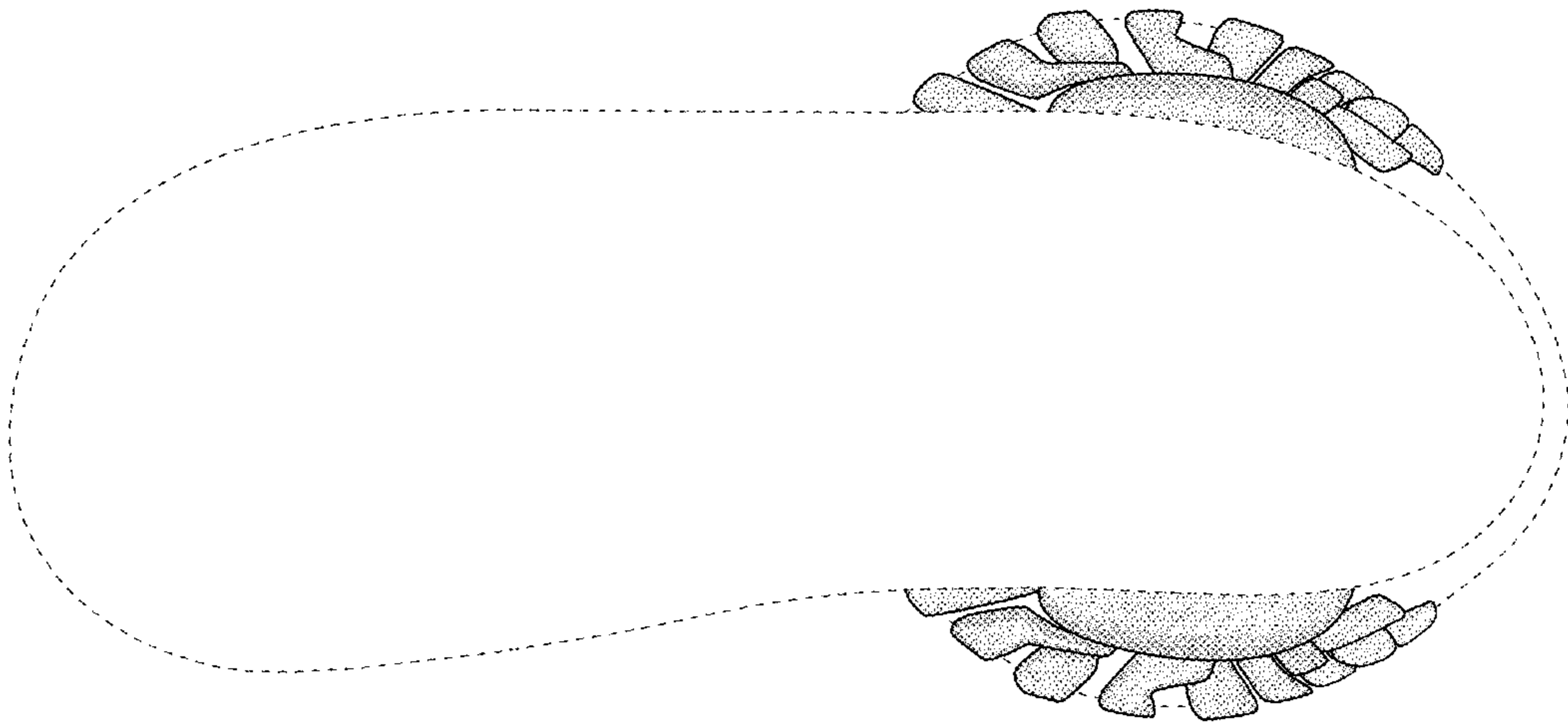

*Fig. 13*

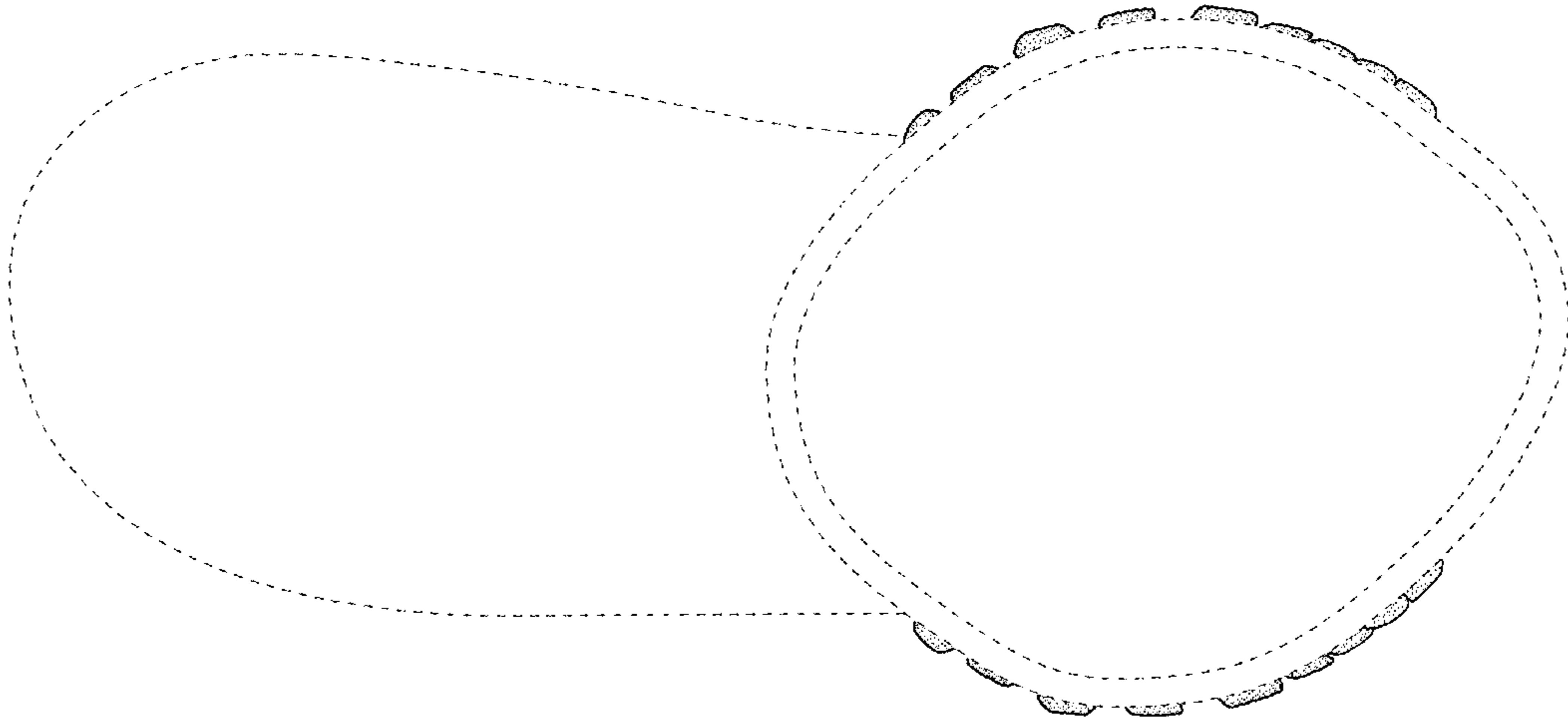

*Fig. 12*

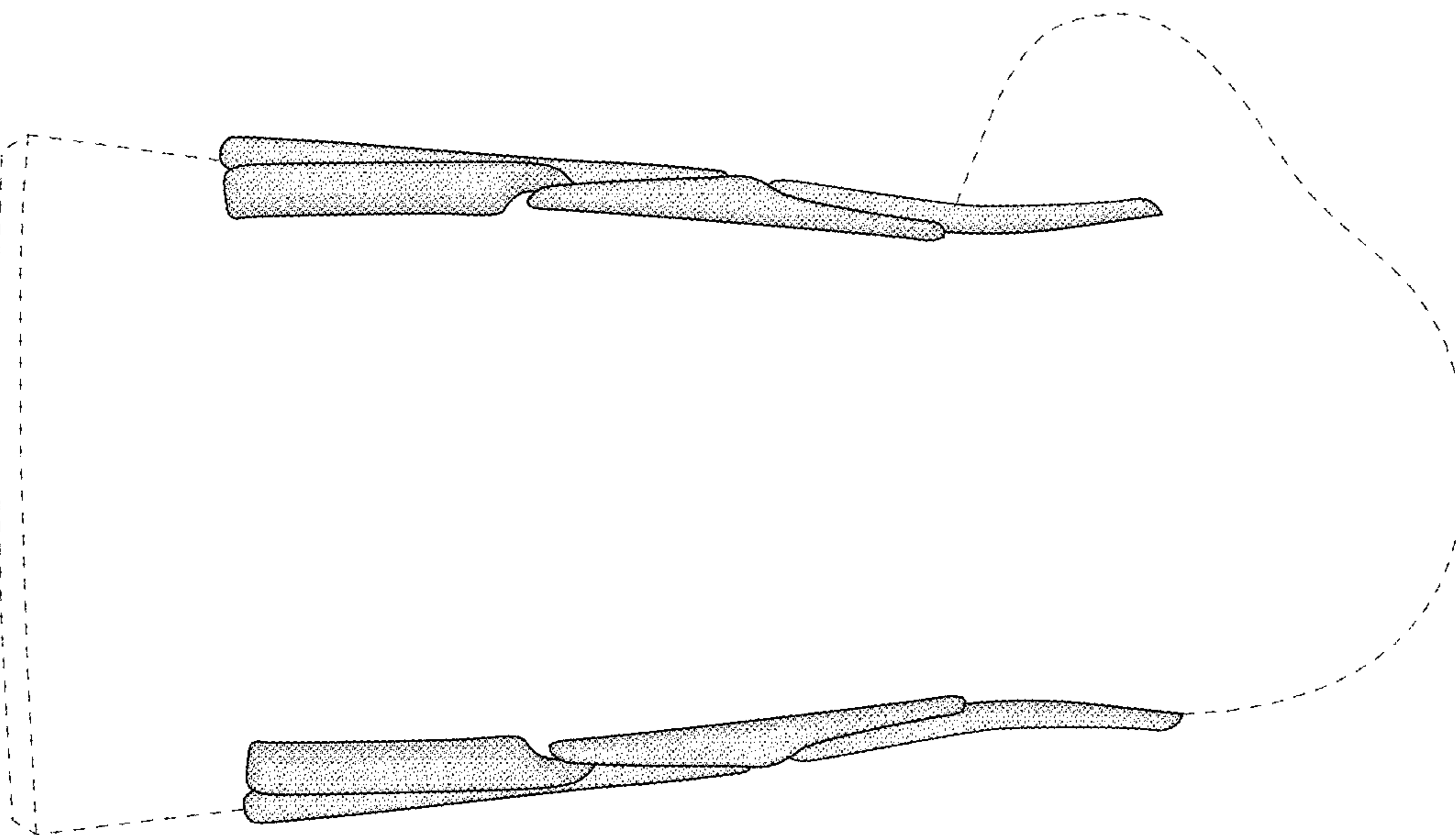

*Fig. 11*

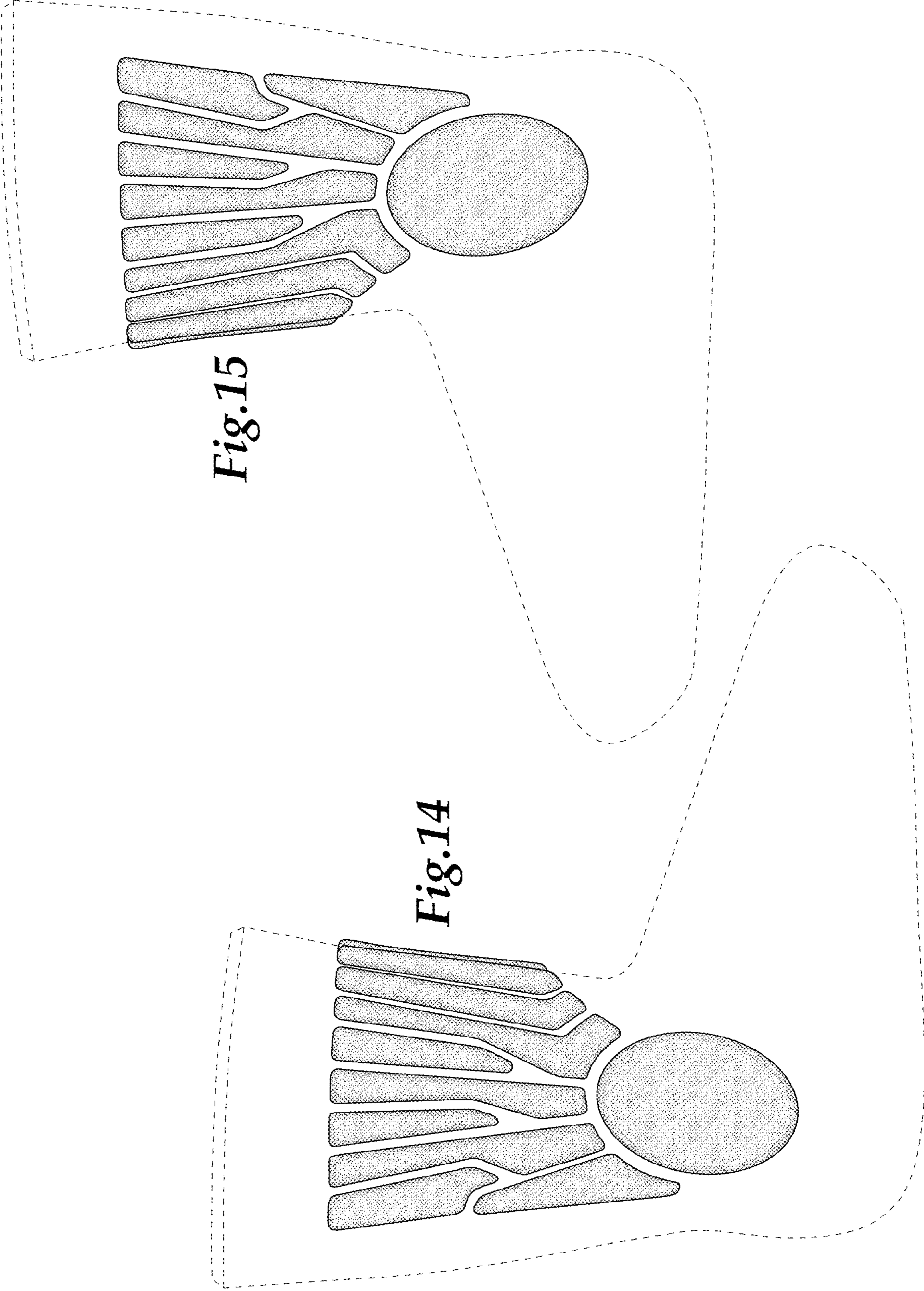

*Fig. 15*

*Fig. 14*



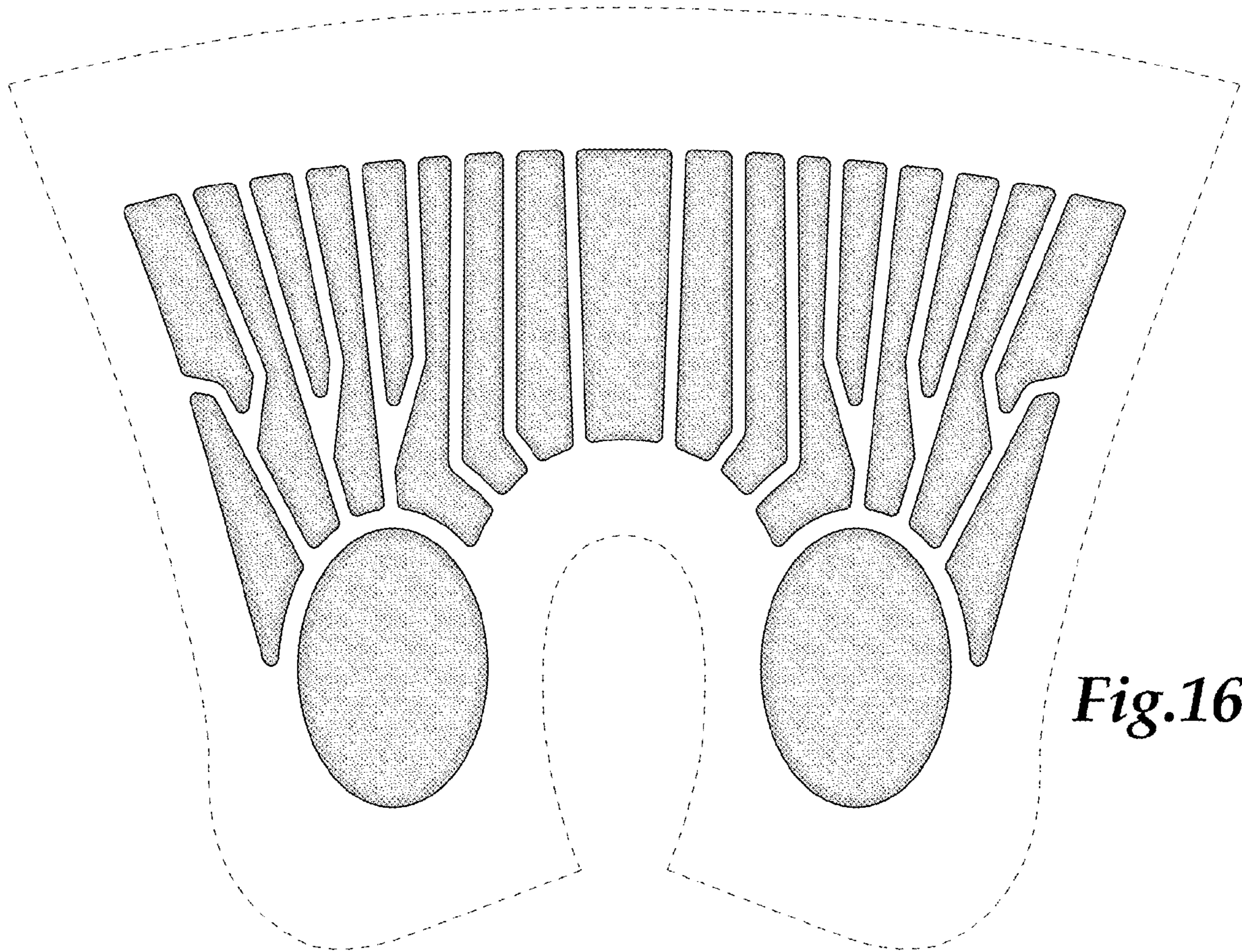

*Fig.16*

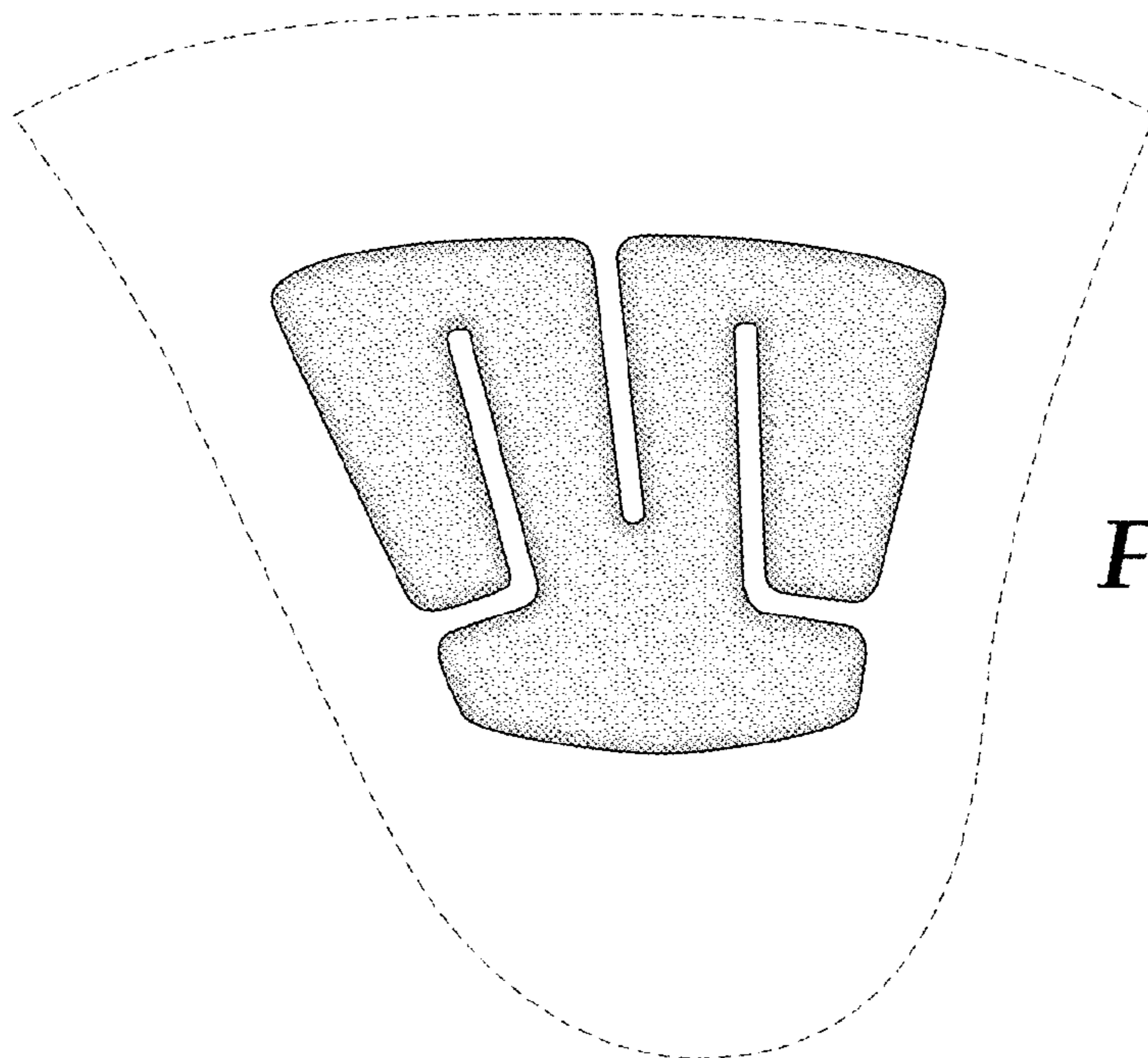

*Fig.17*