



US00D910259S

(12) **United States Design Patent** (10) **Patent No.:** **US D910,259 S**  
**Stack** (45) **Date of Patent:** **\*\* Feb. 9, 2021**

- (54) **DETACHABLE BUCKET BASE**
- (71) Applicant: **Teaghan Jean Stack**, South Bend, IN (US)
- (72) Inventor: **Teaghan Jean Stack**, South Bend, IN (US)
- (\*\*) Term: **15 Years**
- (21) Appl. No.: **29/687,566**
- (22) Filed: **Apr. 13, 2019**
- (51) **LOC (13) Cl.** ..... **32-02**
- (52) **U.S. Cl.**  
USPC ..... **D32/54**
- (58) **Field of Classification Search**  
USPC ..... D3/315-317; D32/54  
CPC ..... B62B 9/00-28; B62B 5/00; A47C 7/62  
See application file for complete search history.

- 6,893,032 B2 \* 5/2005 Kershaw ..... B62B 5/0083  
280/47.11
- D560,047 S \* 1/2008 Kershaw ..... D32/54
- 7,427,076 B2 \* 9/2008 Gwin ..... A47L 13/51  
280/33.998
- 7,597,392 B1 \* 10/2009 Gilmore ..... A47C 7/62  
297/217.1

\* cited by examiner

*Primary Examiner* — Charles D Hanson  
 (74) *Attorney, Agent, or Firm* — Quickpatents, LLC;  
 Kevin Prince

(57) **CLAIM**

The ornamental design for a detachable bucket base, as shown and described.

**DESCRIPTION**

FIG. 1 is a perspective view of a detachable bucket base, showing my new design;  
 FIG. 2 is a perspective view thereof;  
 FIG. 3 is a front elevational view of FIG. 2, the rear elevational view being a mirror image thereof;  
 FIG. 4 is a left-side elevational view thereof, the right-side elevational view being a mirror image thereof;  
 FIG. 5 is a top plan view thereof;  
 FIG. 6 is a bottom plan view thereof; and,  
 FIG. 7 is a cross-sectional view thereof, taken along line 7-7- of FIG. 3.  
 The broken lines showing a bucket in FIG. 1 depict environmental matter and form no part of the claimed design.

**1 Claim, 5 Drawing Sheets**

(56) **References Cited**

U.S. PATENT DOCUMENTS

- D209,870 S \* 1/1968 Yates, Jr. .... D32/53
- D373,865 S \* 9/1996 Wells ..... D32/54
- D383,271 S \* 9/1997 Eshelman ..... D32/54
- D383,275 S \* 9/1997 Hebert ..... D32/54
- 6,209,891 B1 \* 4/2001 Herrmann ..... B44D 3/14  
280/32.6
- 6,488,293 B1 \* 12/2002 Mitchell ..... B62B 3/104  
280/47.34
- D474,404 S \* 5/2003 Tropeano ..... D9/455

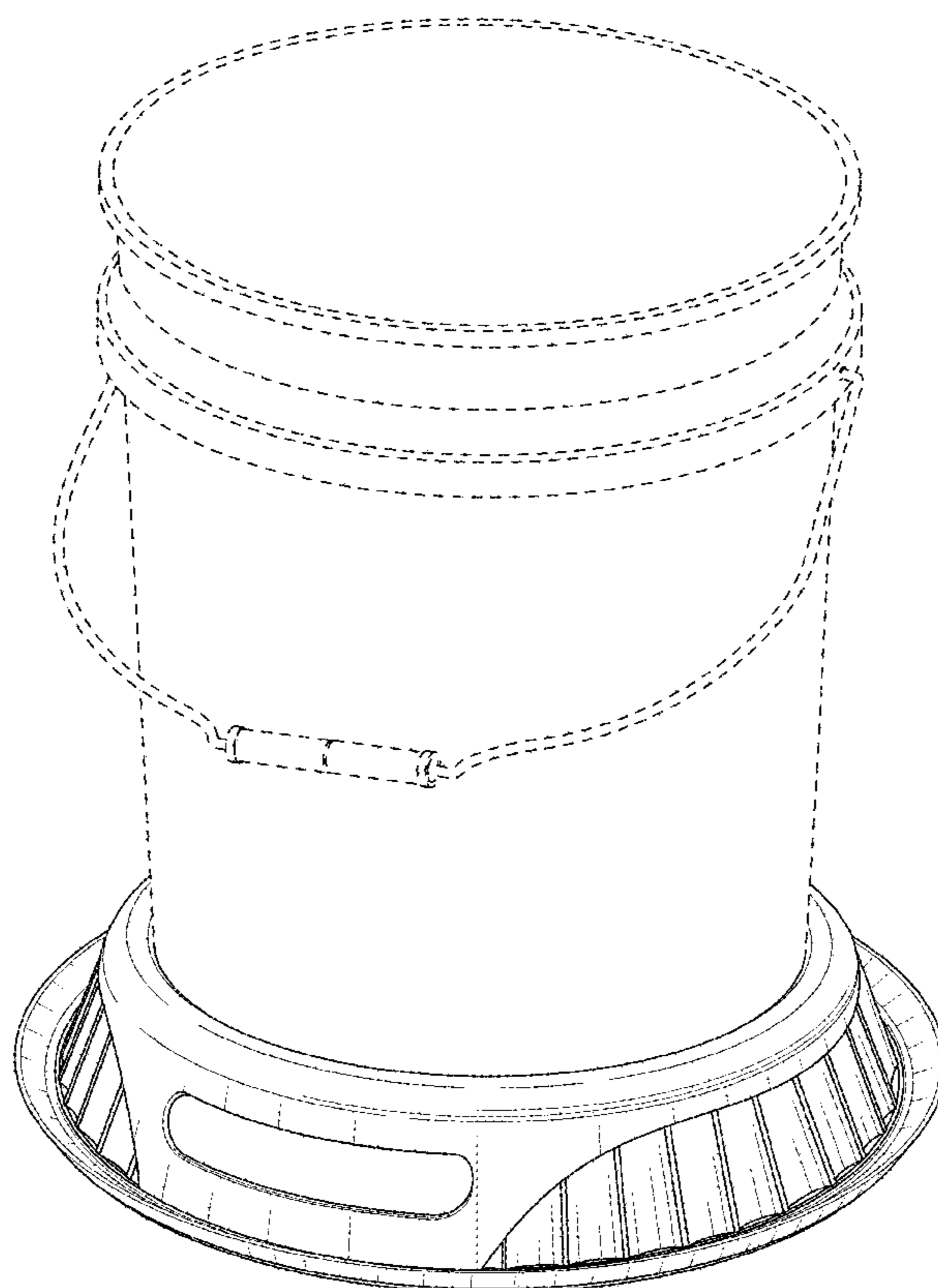

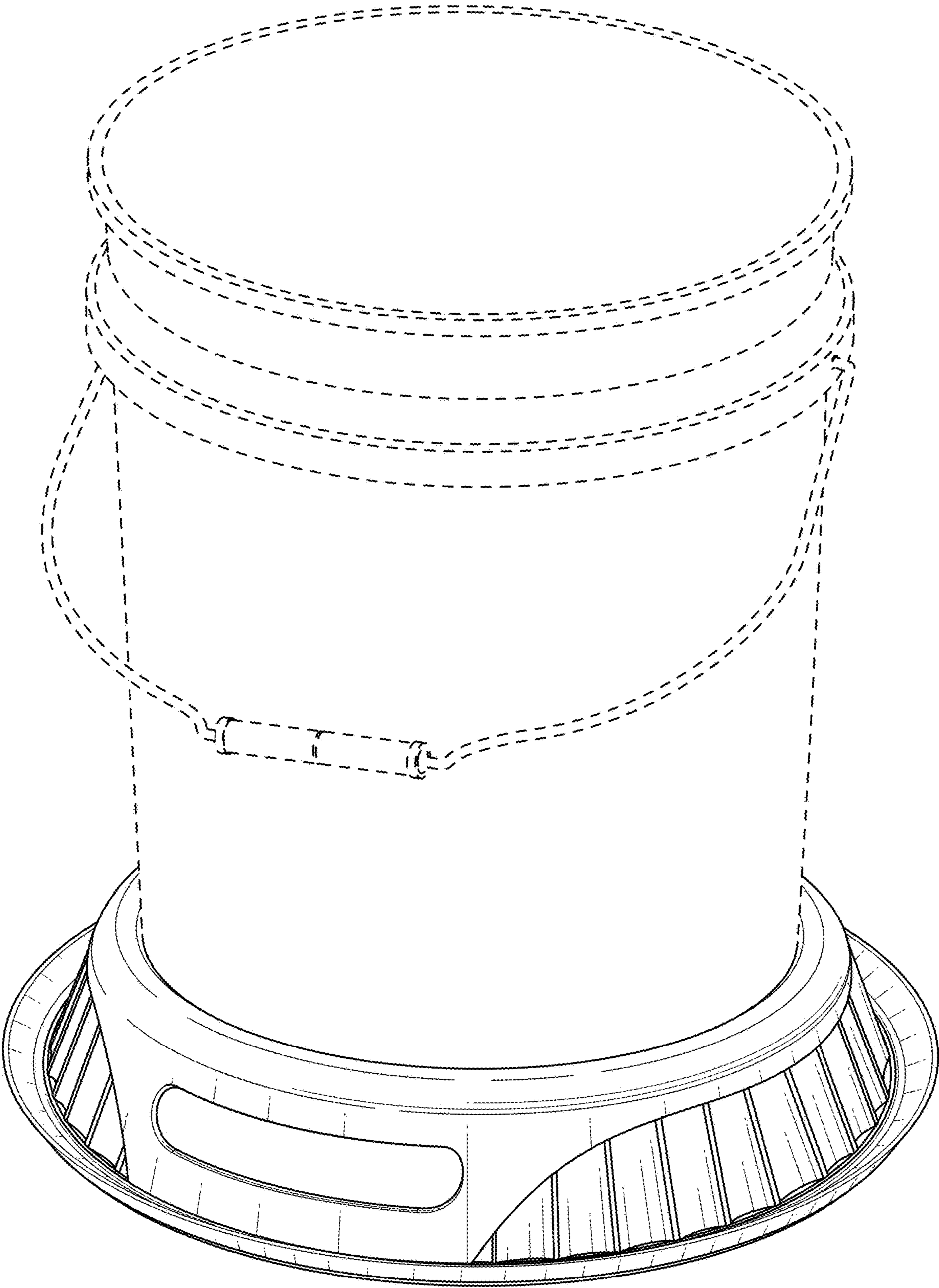

FIG. 1

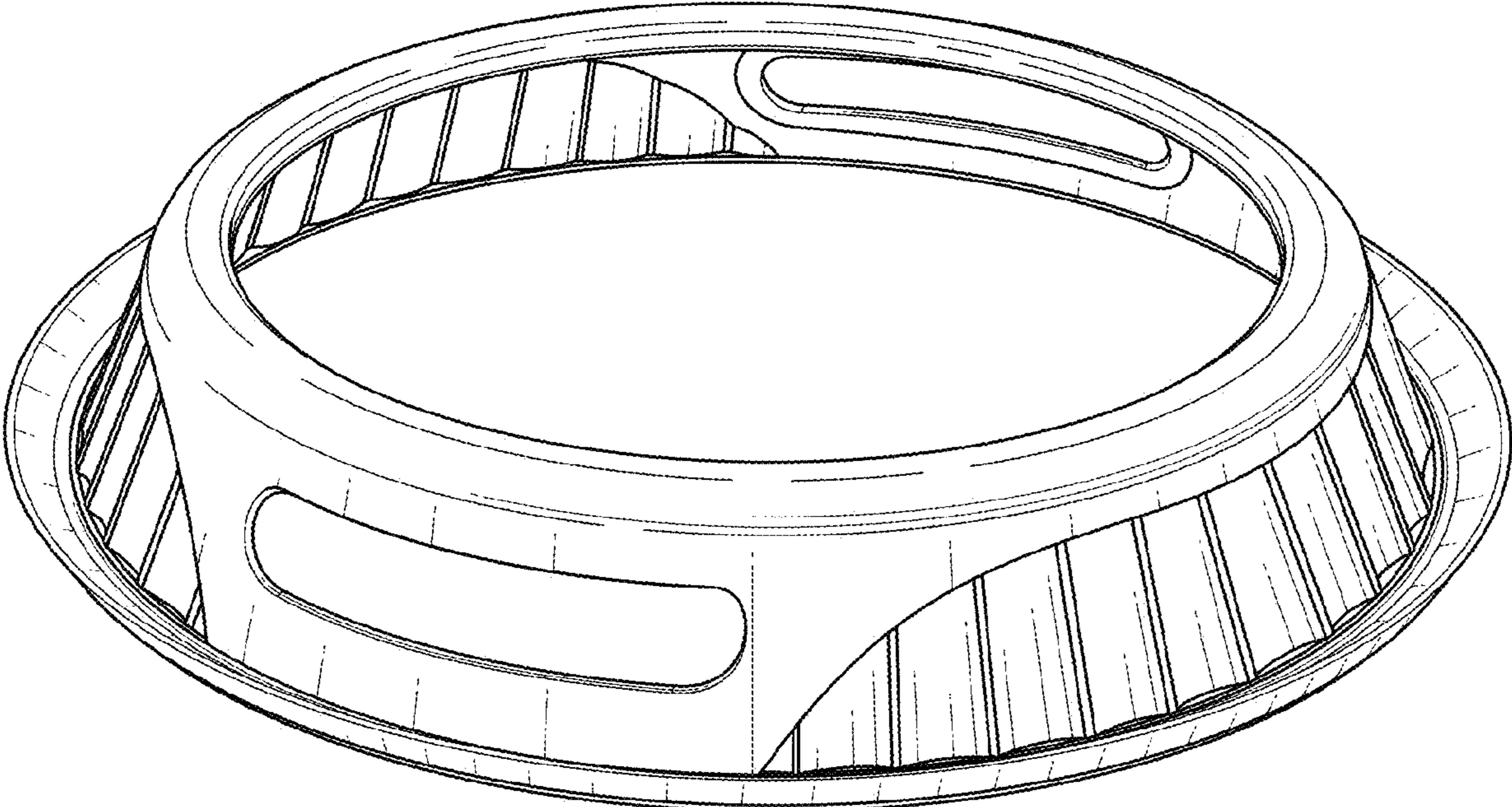

FIG. 2

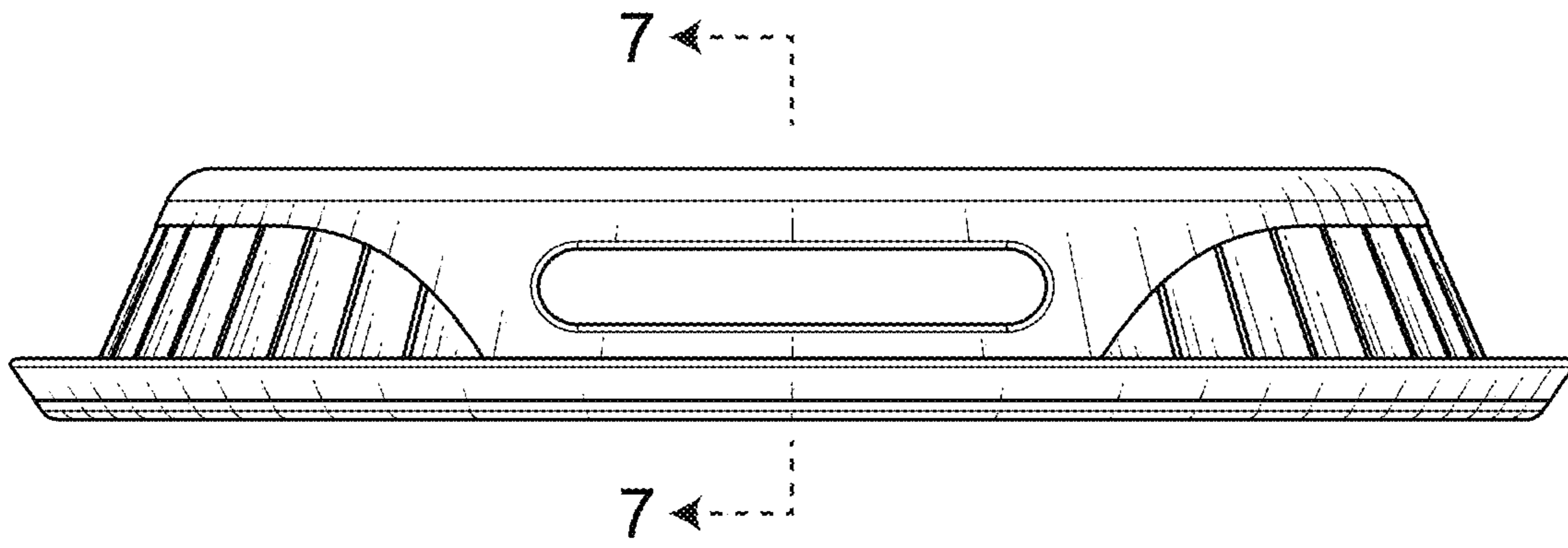

FIG. 3

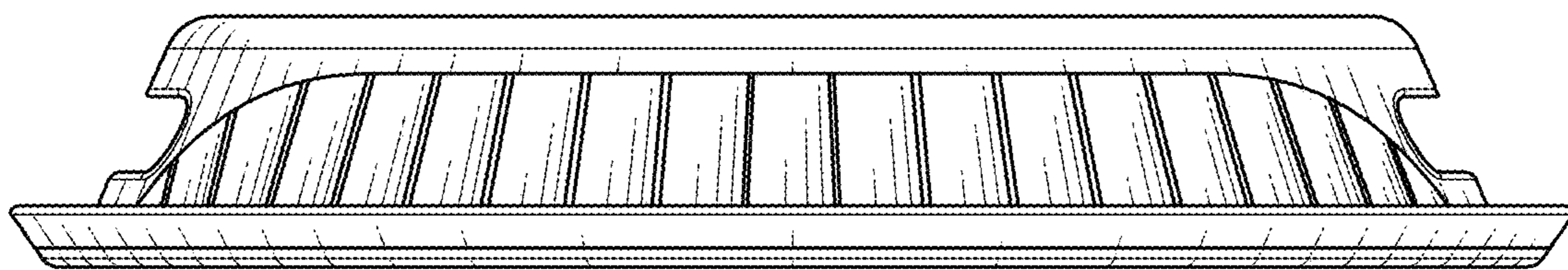

FIG. 4

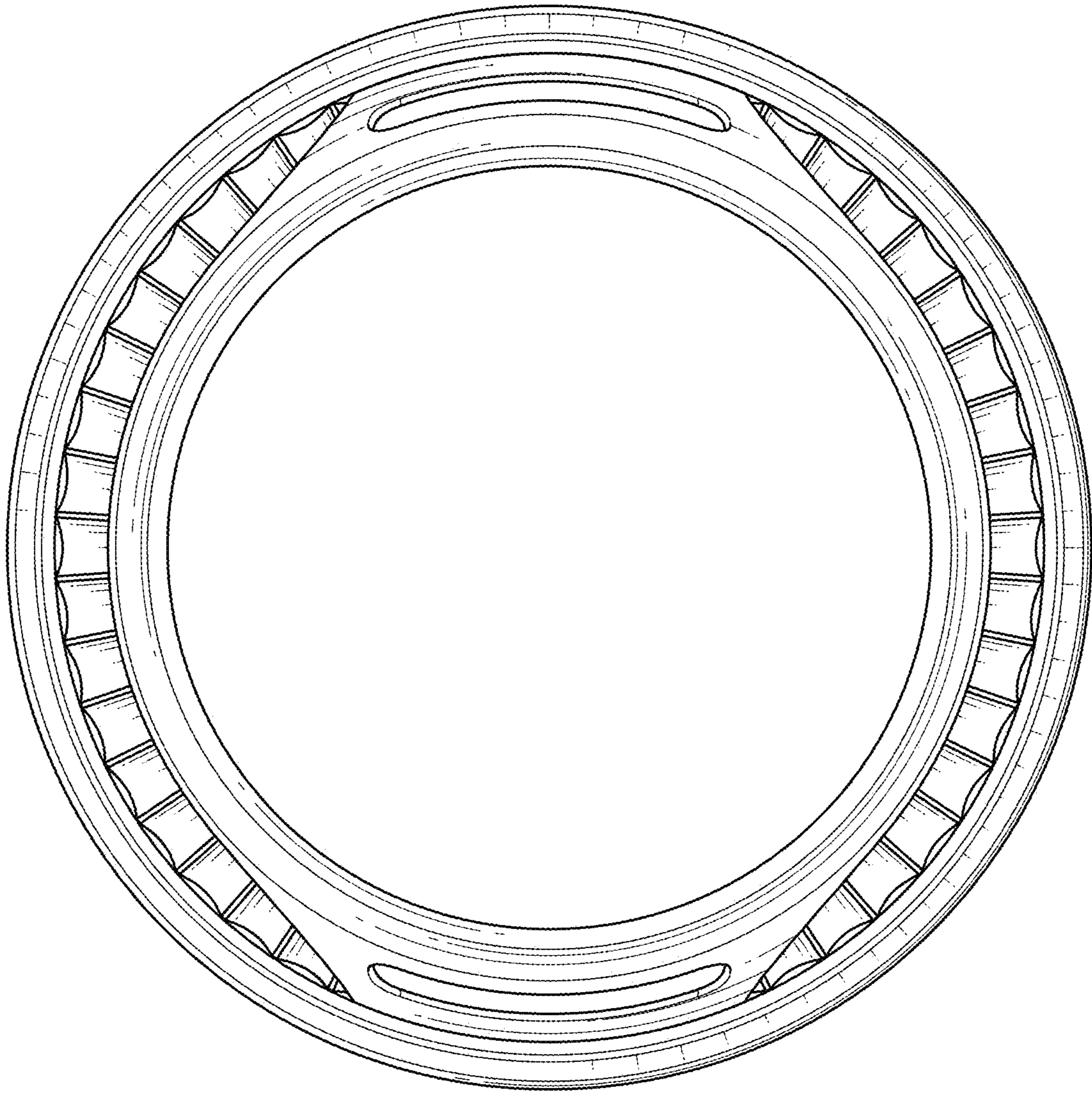

FIG. 5

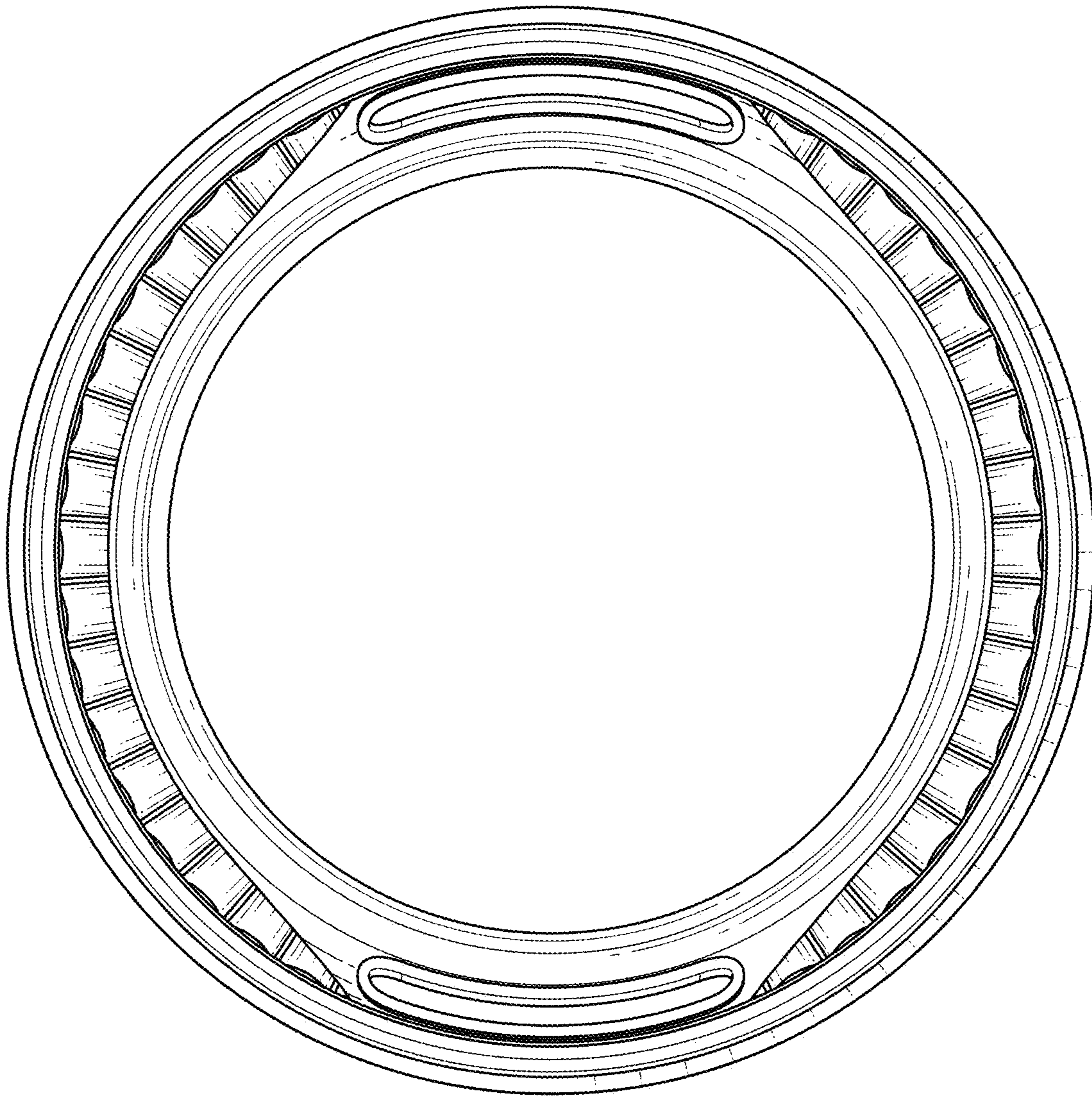

FIG. 6

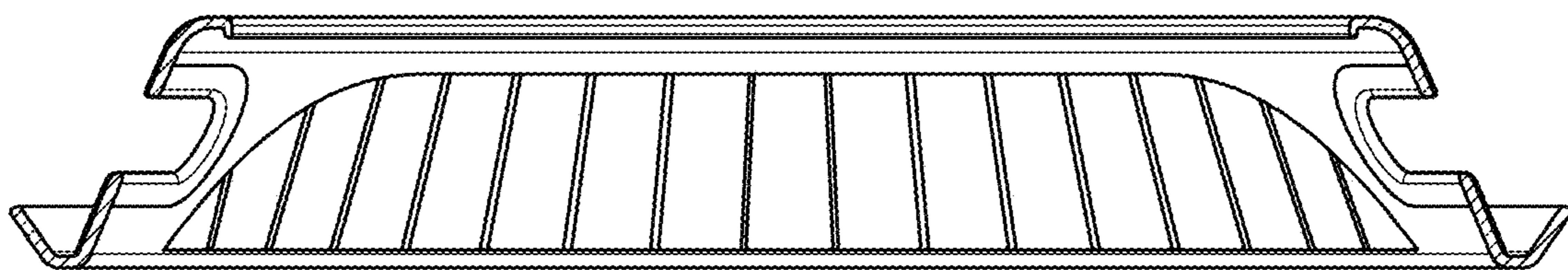

FIG. 7