



US00D910201S

(12) **United States Design Patent** (10) **Patent No.:** **US D910,201 S**
Evans et al. (45) **Date of Patent:** **** Feb. 9, 2021**

(54) **DEVICE FOR FILLING CARTRIDGES**
(71) Applicant: **Gravitron, LLC**, Austin, TX (US)
(72) Inventors: **Micah Evans**, Austin, TX (US); **Travis Dodson**, Austin, TX (US)
(73) Assignee: **Gravitron, LLC**, Austin, TX (US)
(**) Term: **15 Years**
(21) Appl. No.: **29/679,059**
(22) Filed: **Feb. 1, 2019**
(51) **LOC (13) Cl.** **24-02**
(52) **U.S. Cl.**
USPC **D24/224**
(58) **Field of Classification Search**
USPC D24/107, 121-123, 216-217, 219,
D24/223-226, 227, 229-231, 232;
D3/203.1, 304; D27/162-169
CPC B01L 3/50853; B65B 67/02
See application file for complete search history.

10,604,292 B1 * 3/2020 Dodson B65B 1/06
2005/0076969 A1 * 4/2005 Tahil A61J 3/075
141/165
2008/0216312 A1 * 9/2008 Williams B65B 7/2821
29/773
2015/0128534 A1 * 5/2015 Bouthiette B65B 67/02
53/475

* cited by examiner

Primary Examiner — Susan Bennett Hattan
Assistant Examiner — Omeed Agilee
(74) *Attorney, Agent, or Firm* — Dickinson Wright, PLLC; Michael E. Noe, Jr.

(57) **CLAIM**

The ornamental design for a device for filling cartridges, substantially as shown and described.

DESCRIPTION

FIG. 1 is a perspective view of a device for filling cartridges, shown assembled;
FIG. 2 is a right side view thereof;
FIG. 3 is a left side view thereof;
FIG. 4 is a front view thereof;
FIG. 5 is a rear view thereof;
FIG. 6 is a top view thereof; and,
FIG. 7 is a bottom view thereof.

The broken lines in the drawings depict portions of the device for filling cartridges that form no part of the claimed design.

(56) **References Cited**

U.S. PATENT DOCUMENTS

D452,740 S * 1/2002 Brennan D24/216
D507,658 S * 7/2005 Wescott, III B01L 9/06
422/412
D772,426 S * 11/2016 Sanchez D24/222
D872,299 S * 1/2020 Trump D24/224

1 Claim, 5 Drawing Sheets

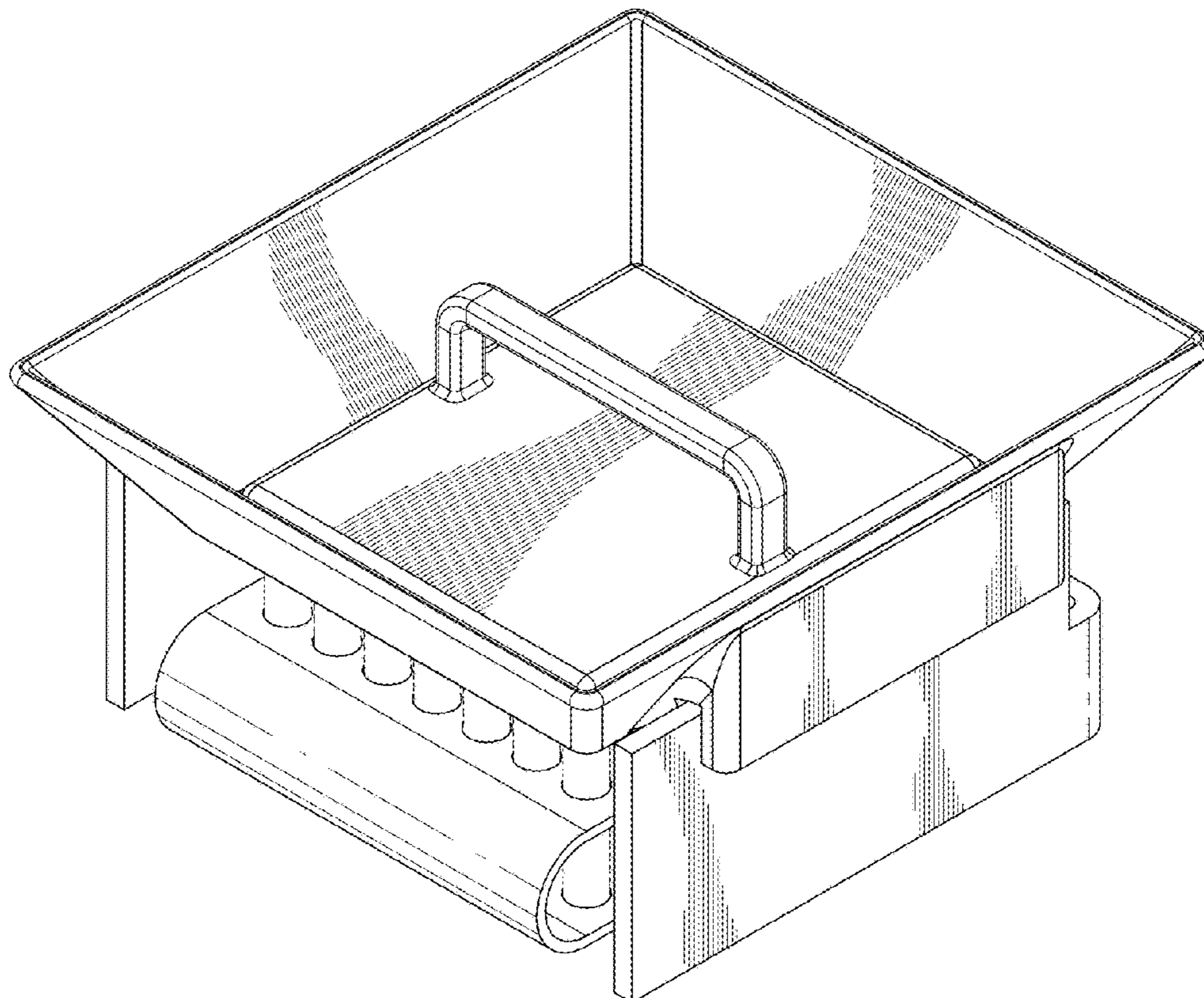

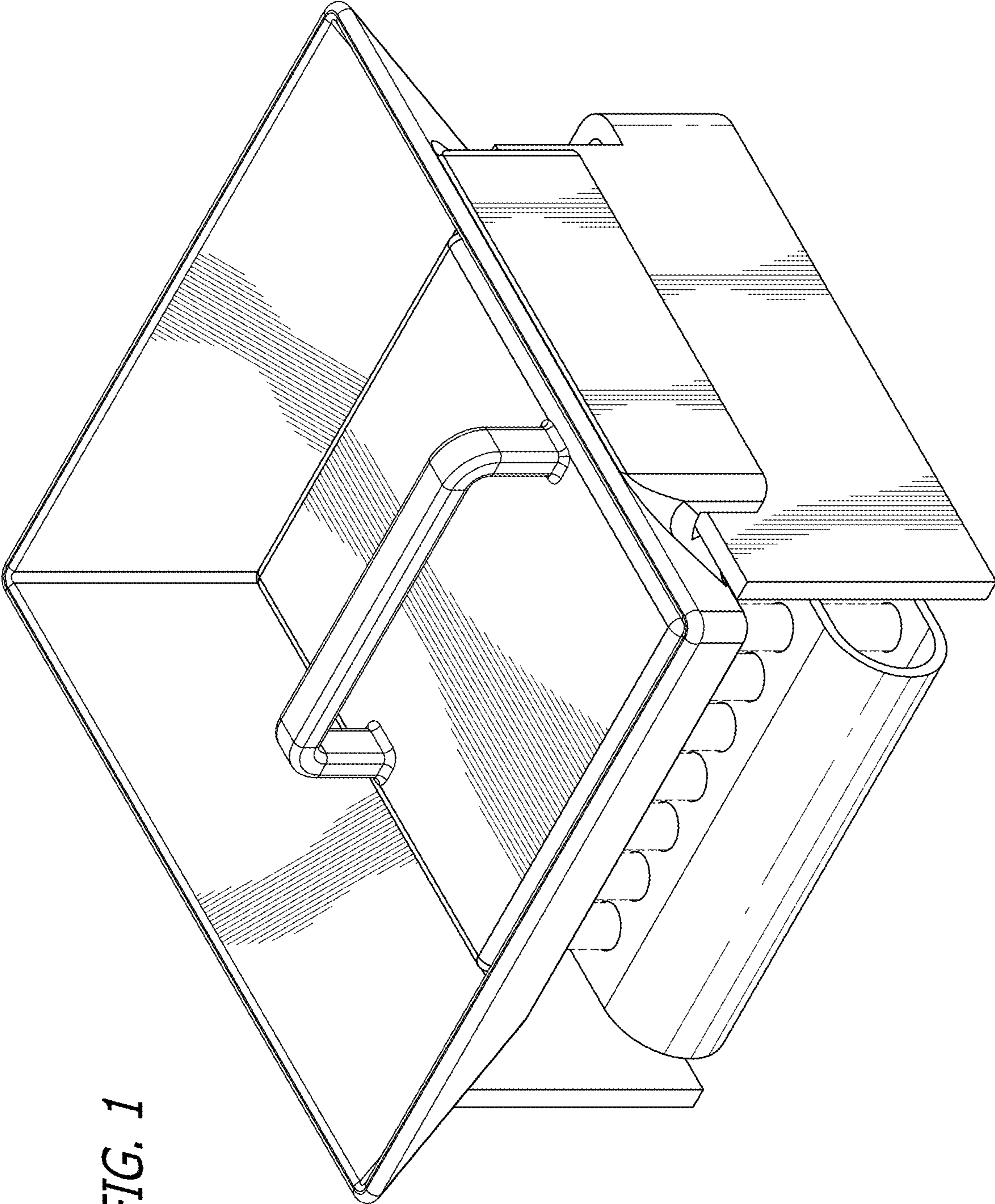

FIG. 1

FIG. 2

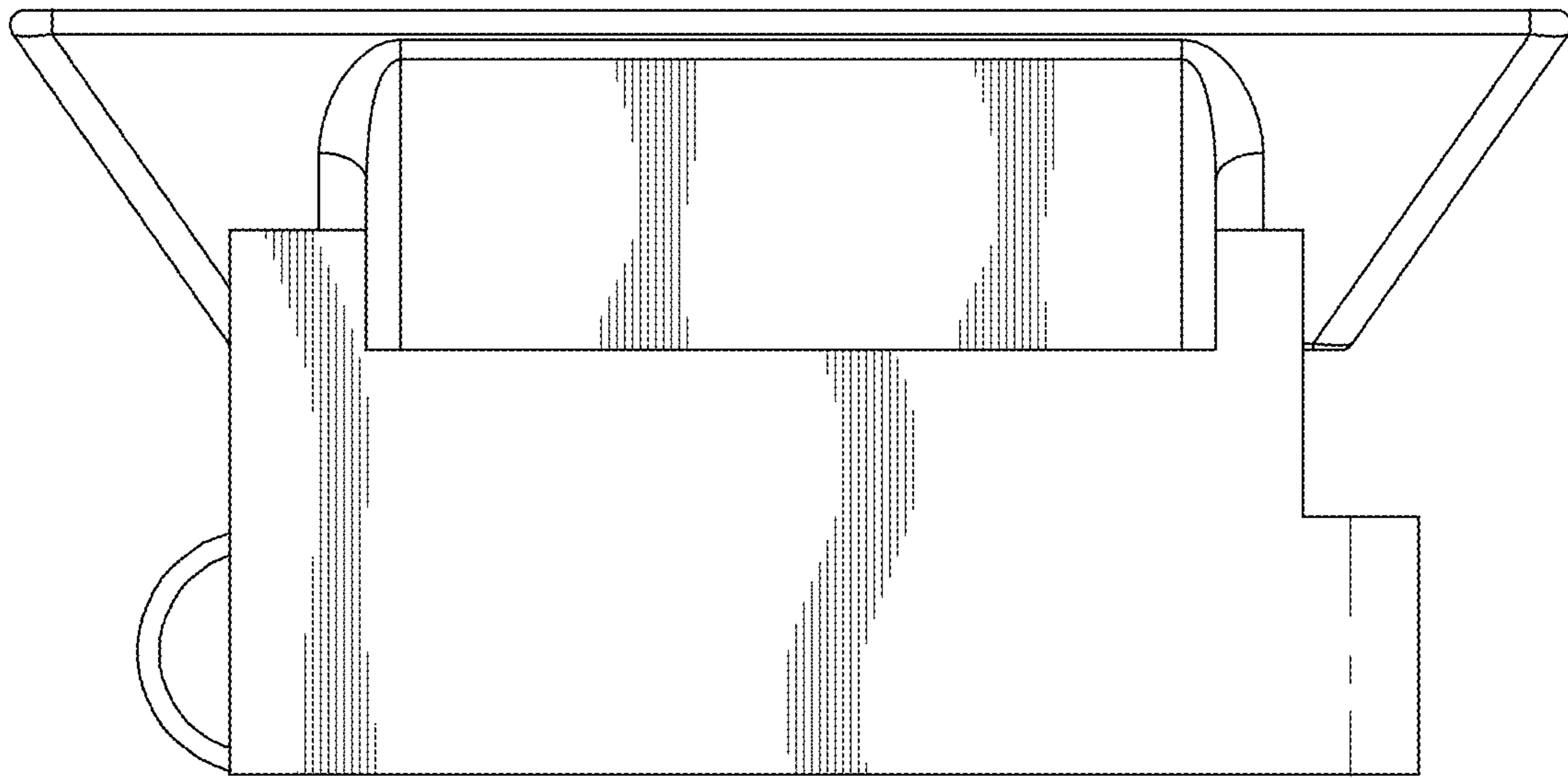

FIG. 3

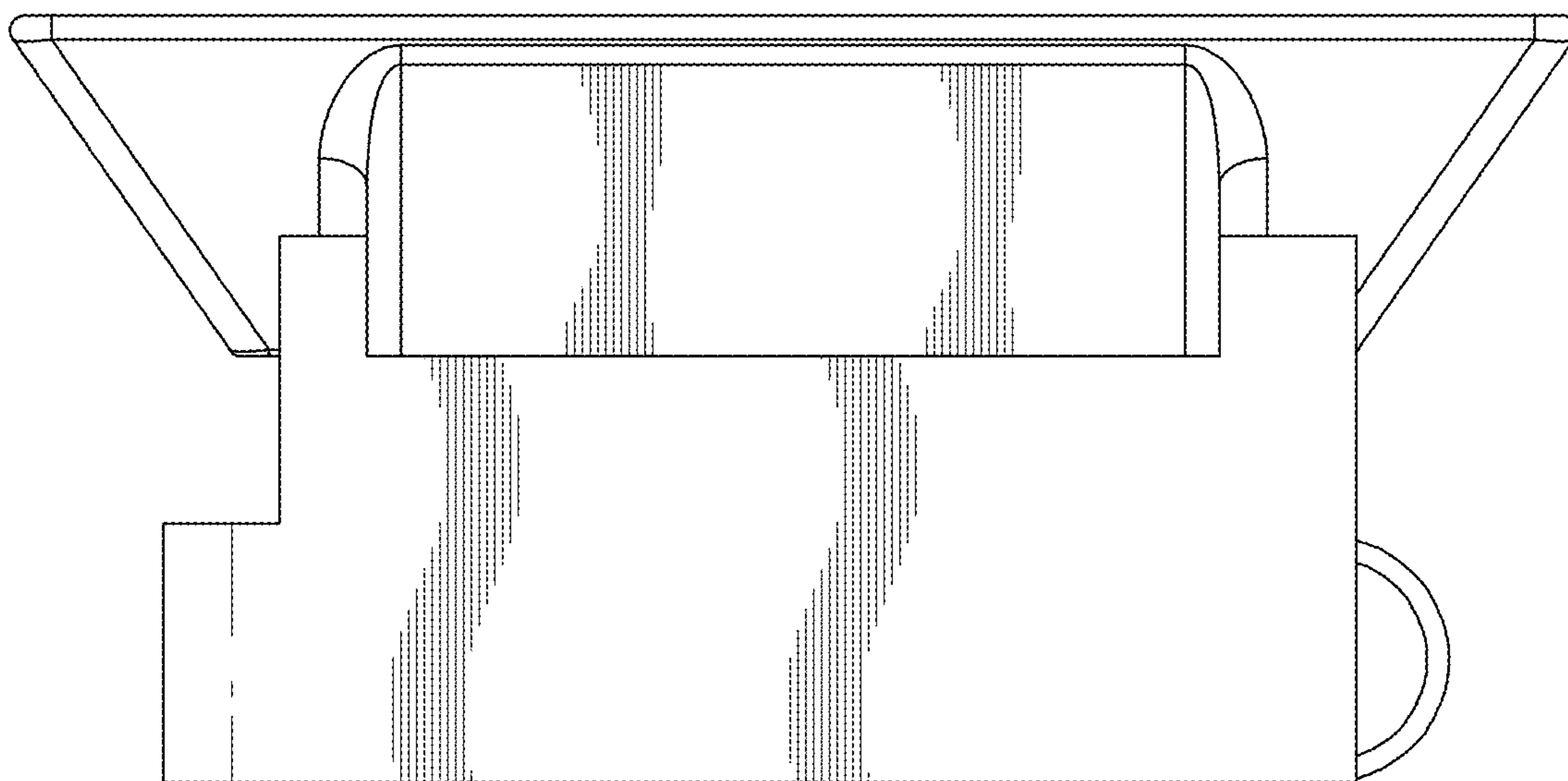

FIG. 4

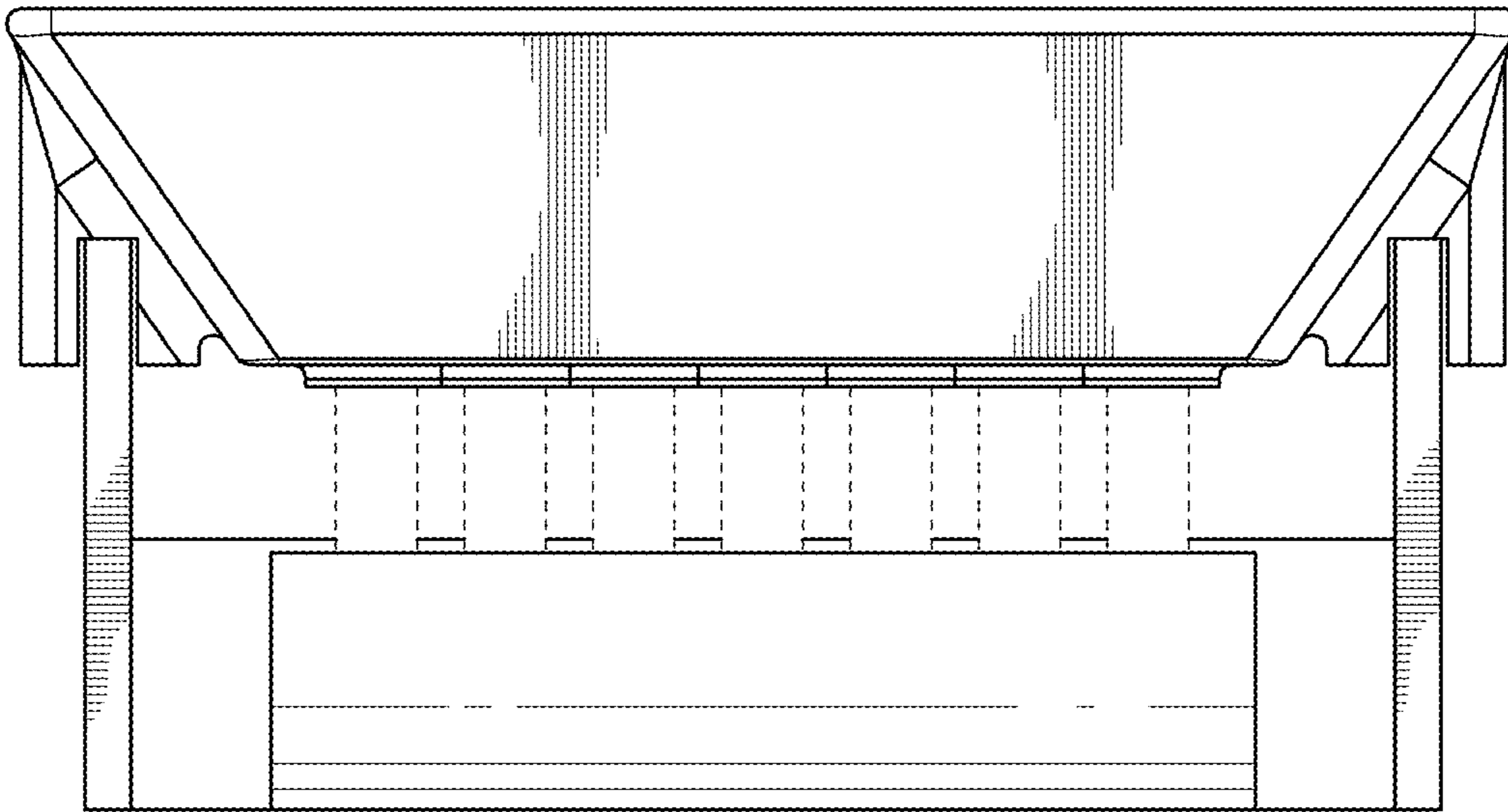
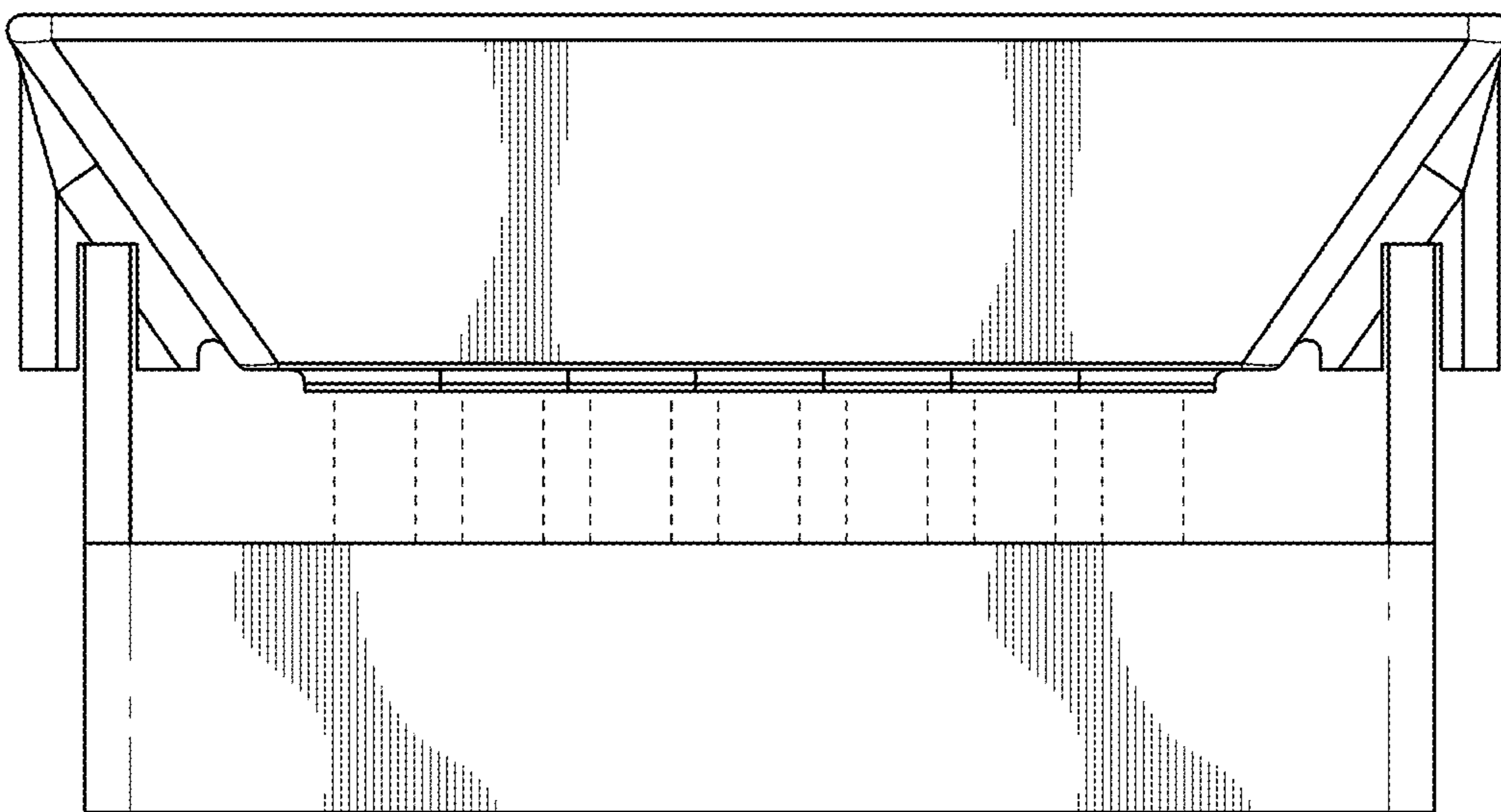

FIG. 5



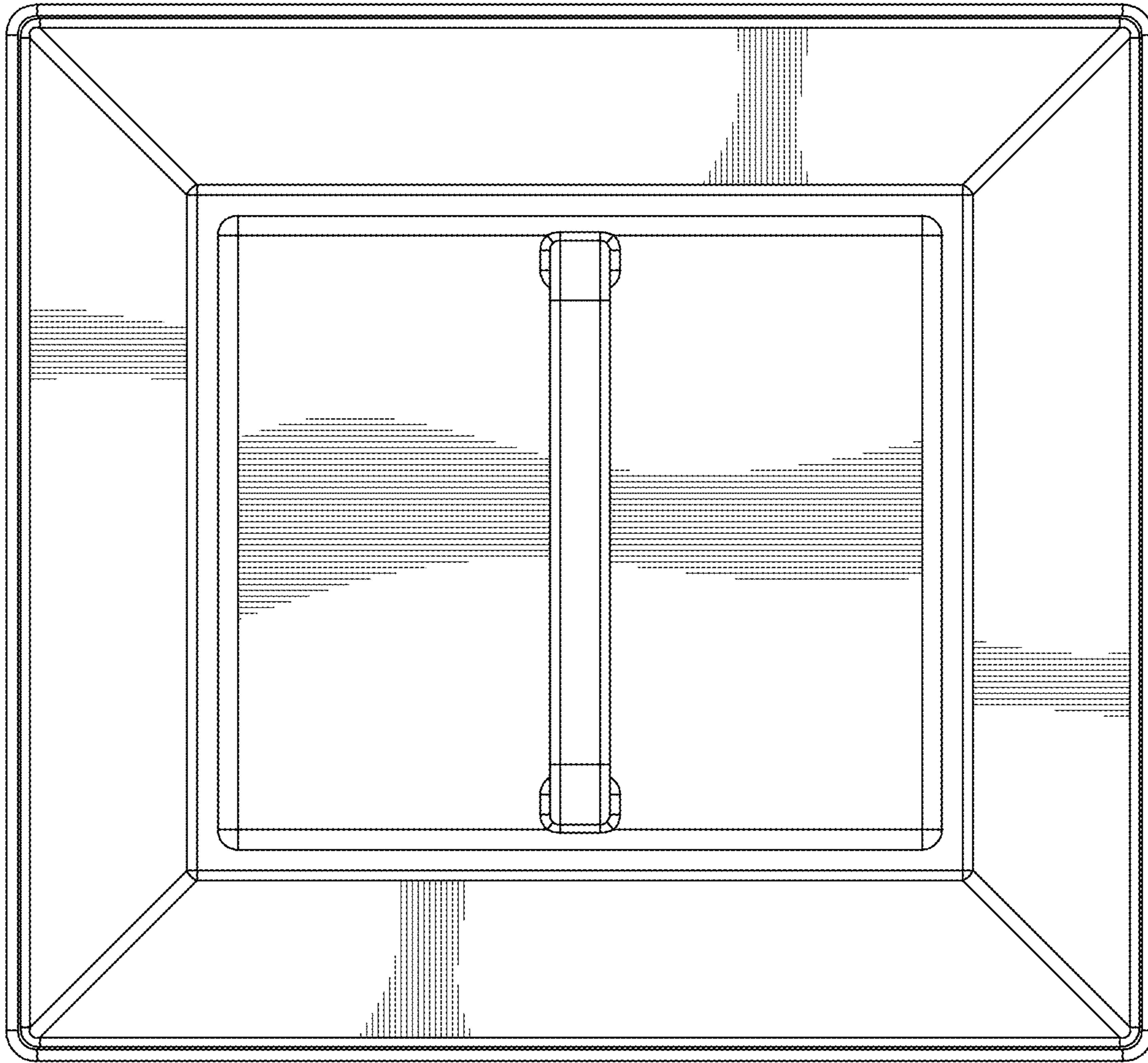

FIG. 6

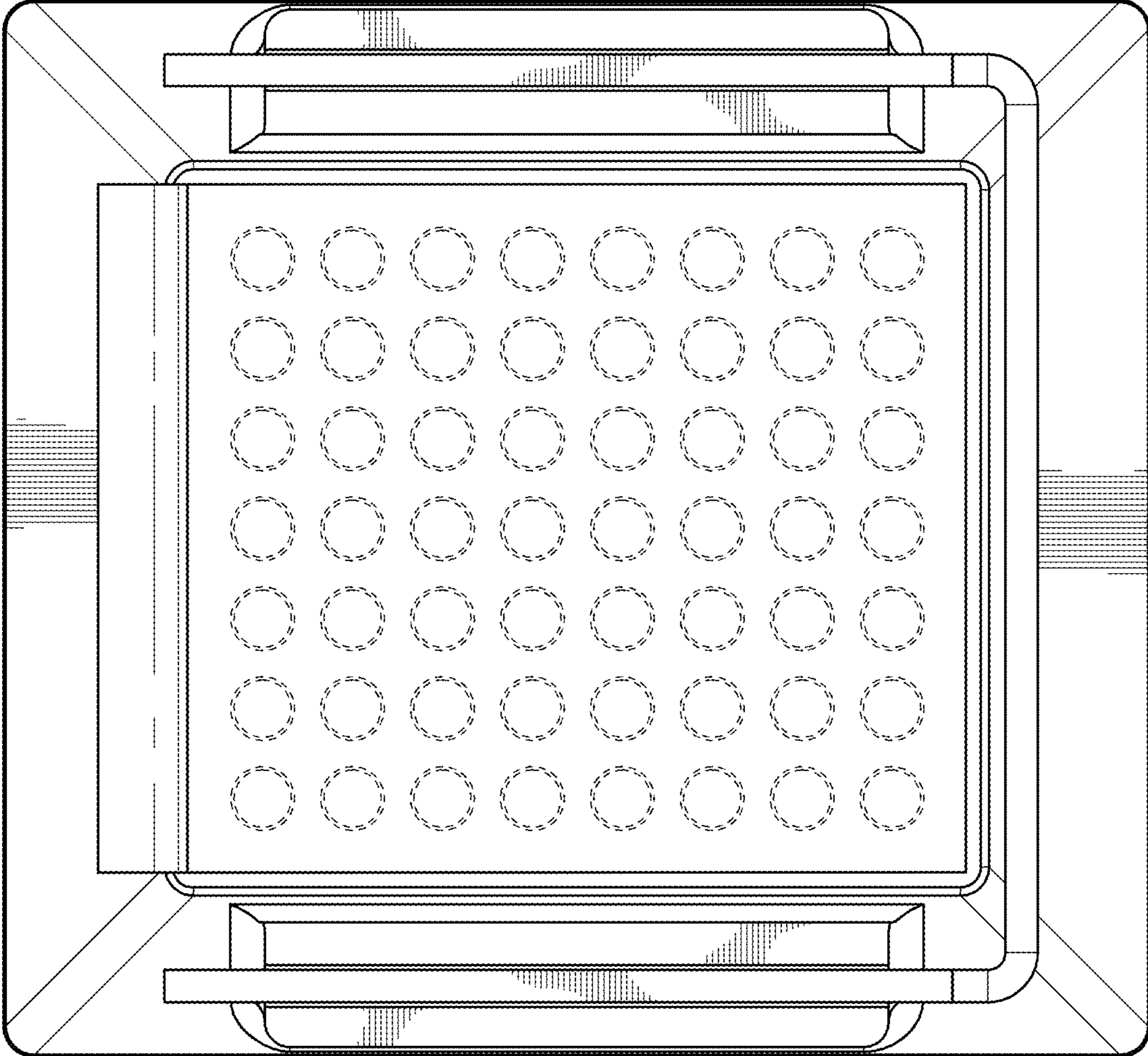

FIG. 7