



US00D910154S

(12) **United States Design Patent** (10) **Patent No.:** **US D910,154 S**
Lee et al. (45) **Date of Patent:** **** Feb. 9, 2021**

(54) **AIR CONDITIONER**

(71) Applicant: **LG Electronics Inc.**, Seoul (KR)

(72) Inventors: **Sangyoon Lee**, Seoul (KR); **Hyesun Lee**, Seoul (KR); **Sehwan Bae**, Seoul (KR); **Seungho Baek**, Seoul (KR); **Hosik Jang**, Seoul (KR); **Ilseop So**, Seoul (KR); **Kyunam Lee**, Seoul (KR)

(73) Assignee: **LG ELECTRONICS INC.**, Seoul (KR)

(**) Term: **15 Years**

(21) Appl. No.: **35/507,333**

(22) Filed: **Feb. 25, 2019**

(80) **Hague Agreement Data**

Int. Filing Date: **Feb. 25, 2019**
Int. Reg. No.: **DM/201144**
Int. Reg. Date: **Feb. 25, 2019**
Int. Reg. Pub. Date: **Aug. 30, 2019**

(51) **LOC (13) Cl.** **23-04**

(52) **U.S. Cl.**
USPC **D23/333**
CPC **F24F 11/30** (2018.01)

(58) **Field of Classification Search**

USPC D23/333, 335, 341, 342, 351, 353, 354, D23/355, 356, 359, 364, 365, 370, 385, D23/386, 388, 393
CPC .. F24F 11/30; F24F 11/52; F24F 11/46; F24F 11/83; F24F 2110/10; F24F 3/14; F24F 11/0001; F24F 11/54; F24F 11/56; F24F 11/58; F24F 11/62; F24F 11/64; F24F 11/66; F24F 11/70; F24F 11/72; F24F 11/74; F24F 11/76; F24F 11/77; F24F 11/84; F24F 11/85; F24F 11/86; F24F 11/89; F24F 13/20; F24F 13/28; F24F 1/022; F24F 1/38; F24F 2006/008; F24F 2006/046; F24F 2110/00; F24F 2110/40; F24F 2110/50; F24F 2110/64; F24F

2120/10; F24F 2140/12; F24F 2140/40; F24F 2140/50; F24F 2221/54; F24F 3/044; F24F 3/0442; F24F 3/0444; F24F 3/08; F24F 5/00; F24F 5/0003; F24F 6/04; F24F 6/16; F24F 7/007; F24F 7/10
See application file for complete search history.

(56) **References Cited**

U.S. PATENT DOCUMENTS

D580,537	S	*	11/2008	Niki	D23/351
D624,167	S	*	9/2010	Mishiro	D23/351
D701,295	S	*	3/2014	Chouji	D23/351
D720,444	S	*	12/2014	Chouji	D23/351
D720,842	S	*	1/2015	Chouji	D23/351
D726,295	S	*	4/2015	Kim	D23/351
D802,108	S	*	11/2017	Birchler	D23/351
D824,502	S	*	7/2018	Kudo	D23/351
D827,798	S	*	9/2018	Guan	D23/351

(Continued)

Primary Examiner — Richard E Chilcot

(74) *Attorney, Agent, or Firm* — Birch, Stewart, Kolasch & Birch, LLP

(57) **CLAIM**

The ornamental design for an air conditioner, as shown and described.

DESCRIPTION

1. Air conditioner

Reproduction 1.1 is a front perspective view of the air conditioner.

Reproduction 1.2 is a front view thereof.

Reproduction 1.3 is a back view thereof.

Reproduction 1.4 is a left view thereof.

Reproduction 1.5 is a right view thereof.

Reproduction 1.6 is a top view thereof.

Reproduction 1.7 is a bottom view thereof.

Reproduction 1.8 is a reference view showing the use state in which the display part is operated.

(Continued)

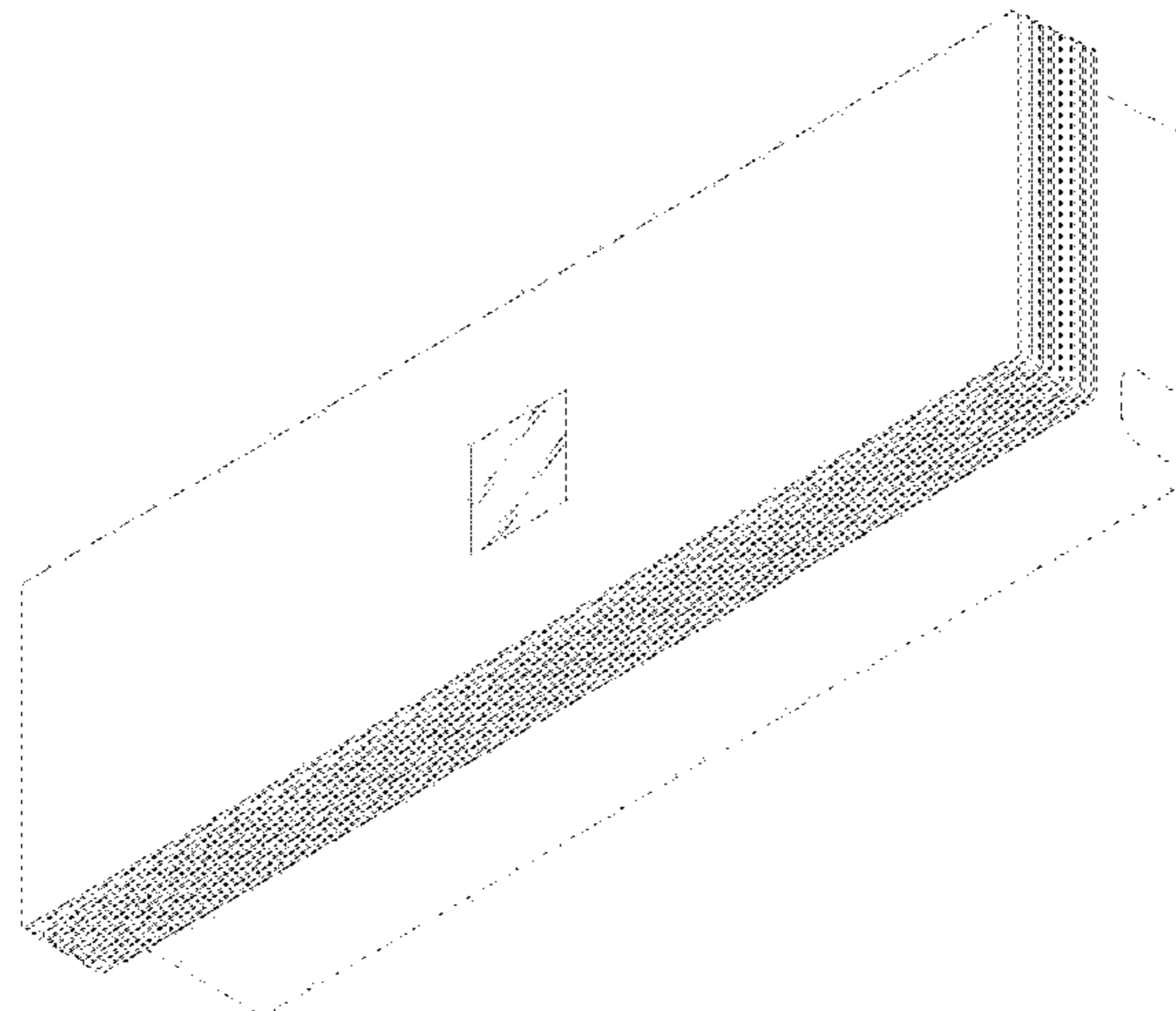

The broken lines depict portions of the air conditioner that form no part of the claimed design; the fine lines on the drawings indicate the display part.

1 Claim, 8 Drawing Sheets

(56)

References Cited

U.S. PATENT DOCUMENTS

D855,166 S * 7/2019 Bae D23/351
D873,398 S * 1/2020 Seo D23/364

* cited by examiner

1.1

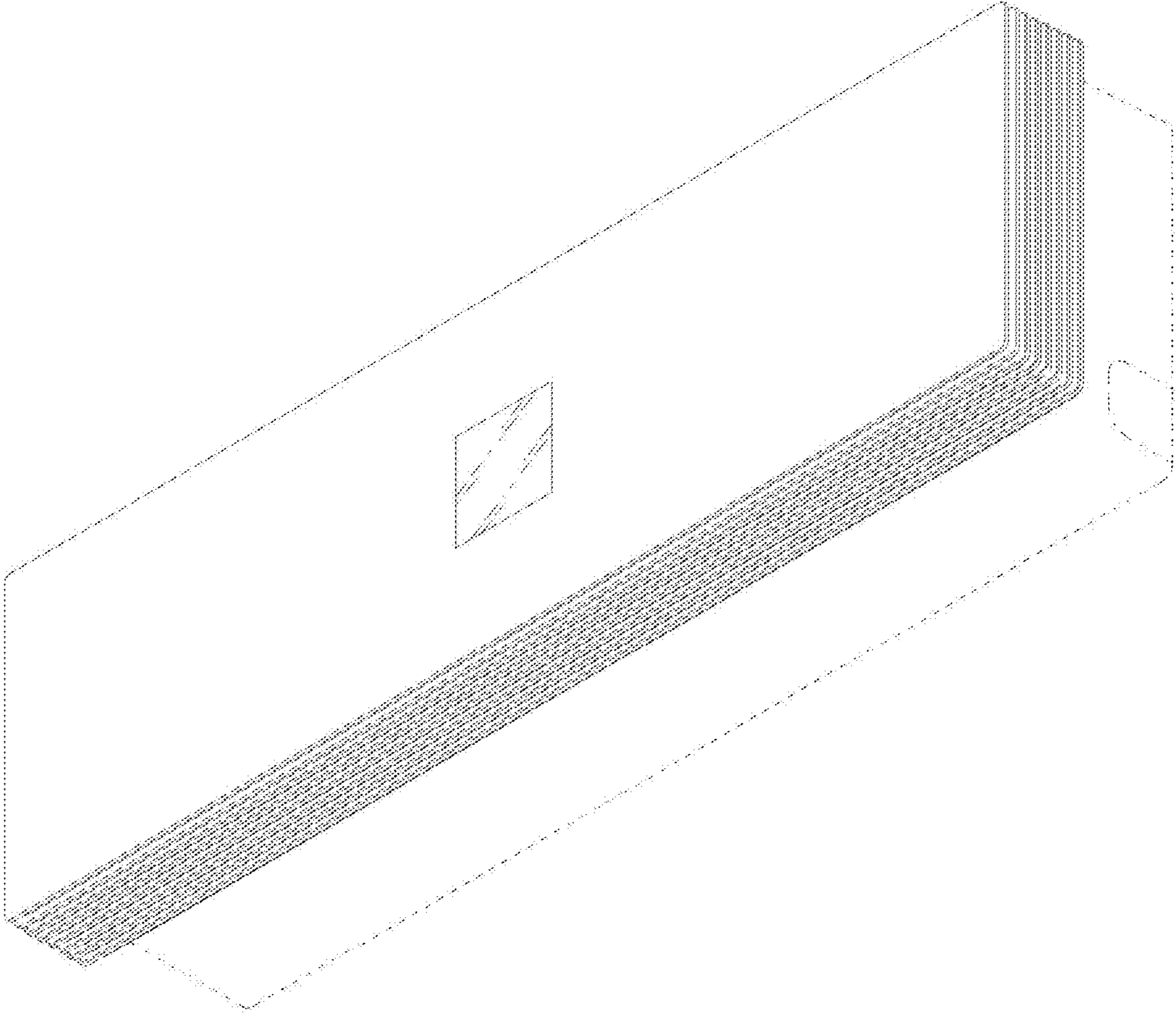

1.2

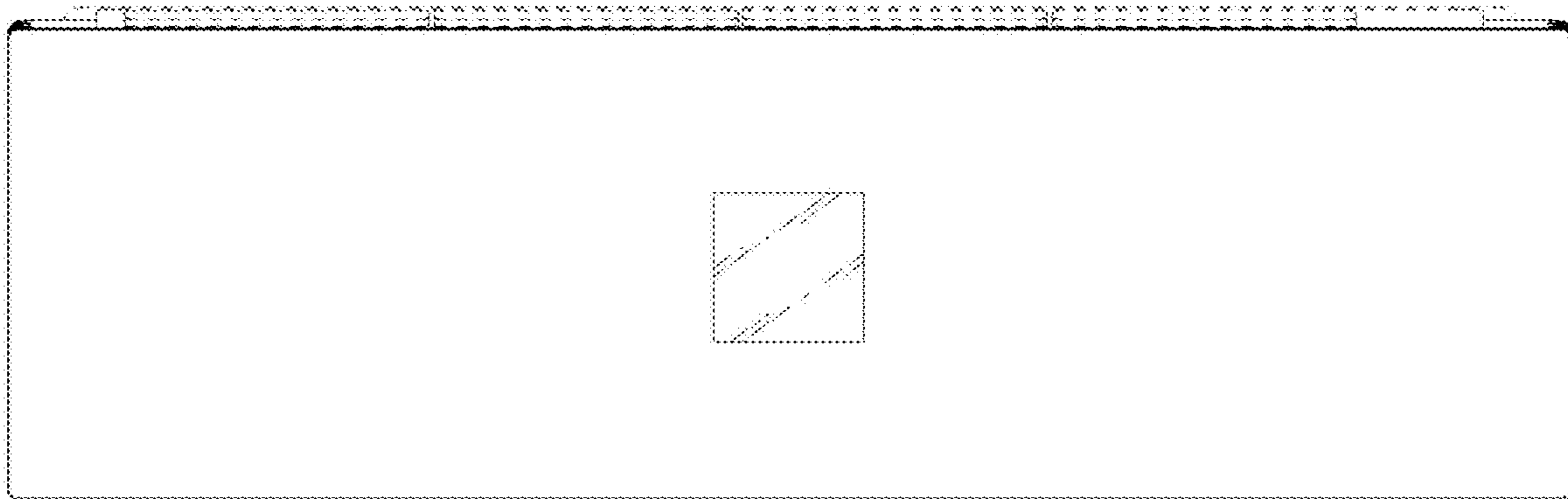

1.3



1.4

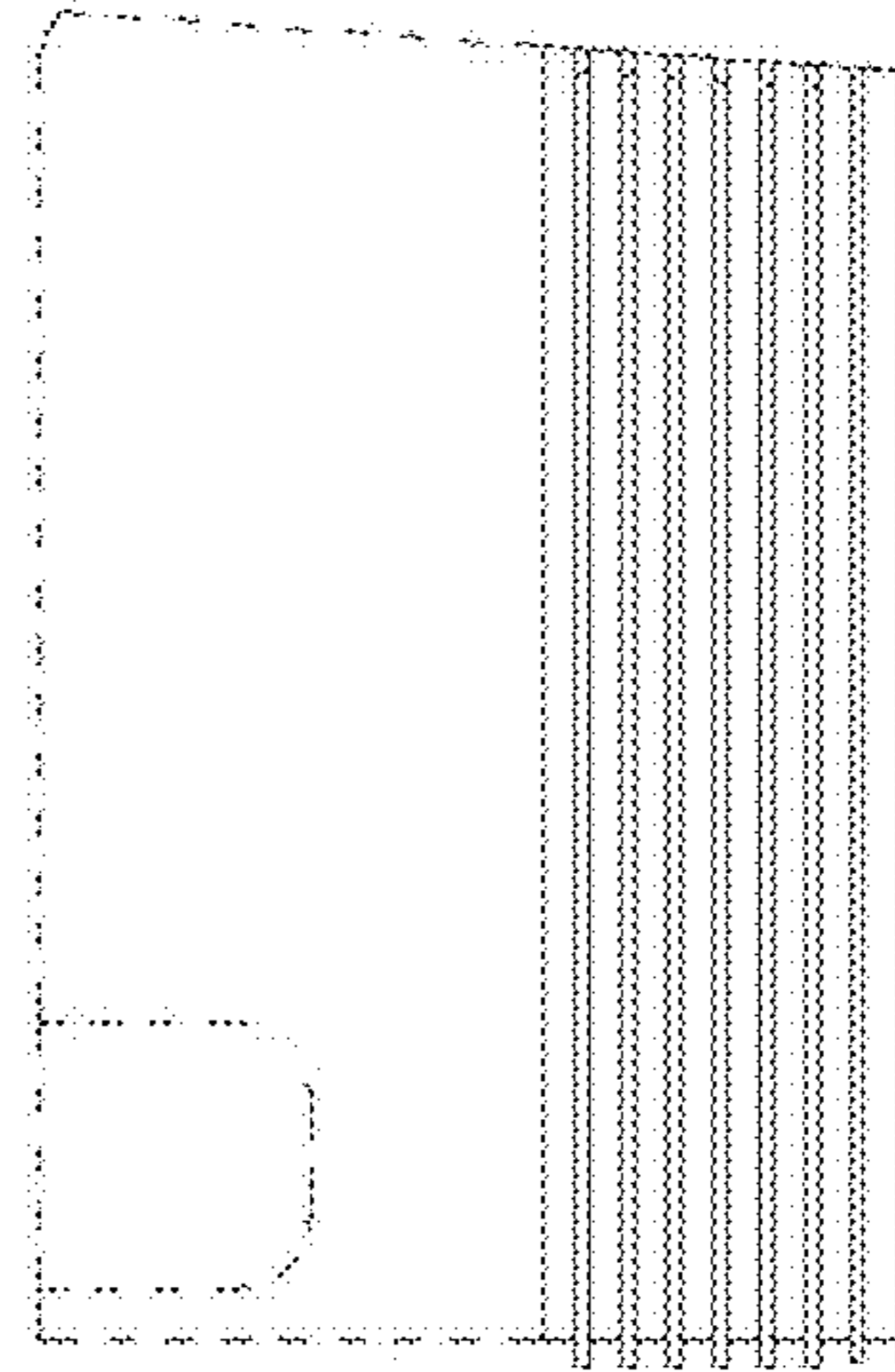

1.5

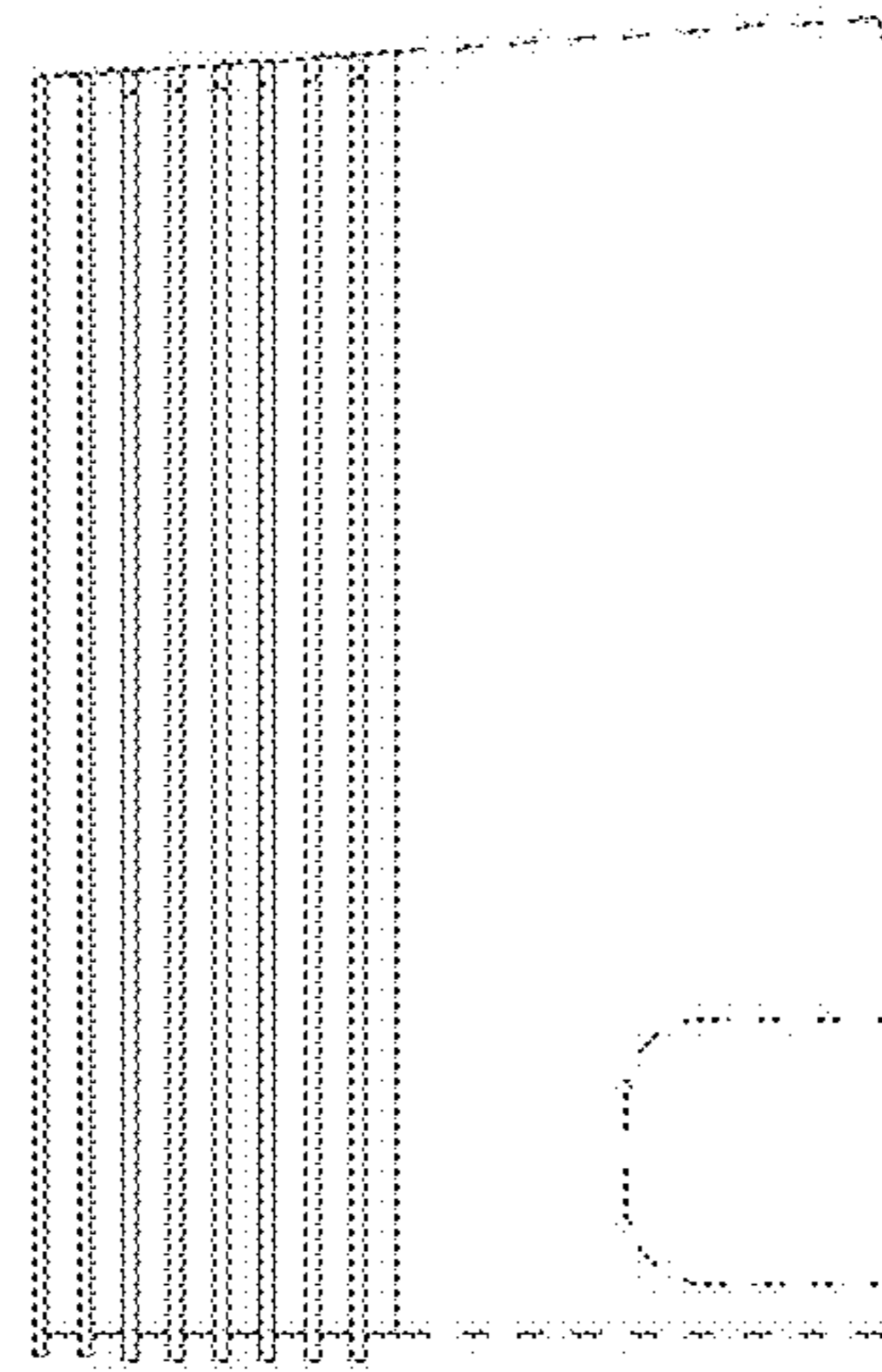

1.6

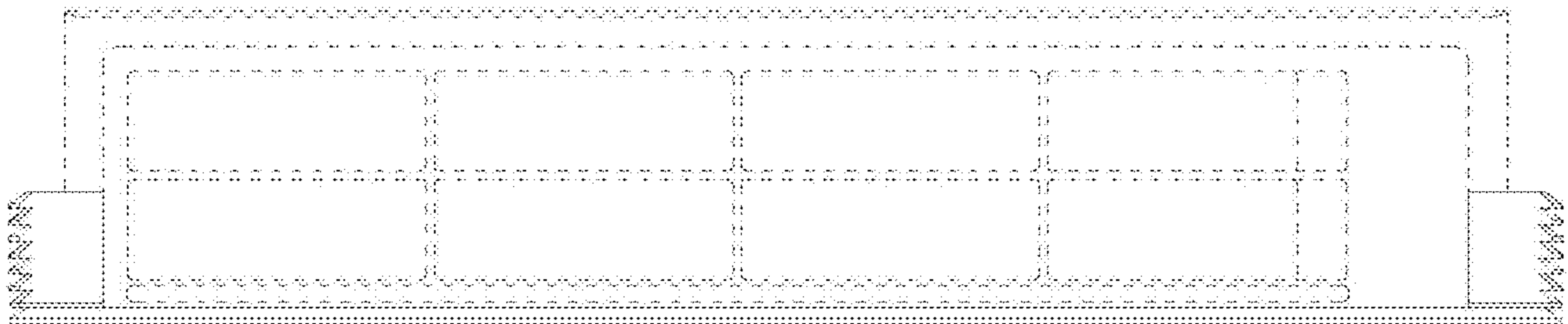

1.7

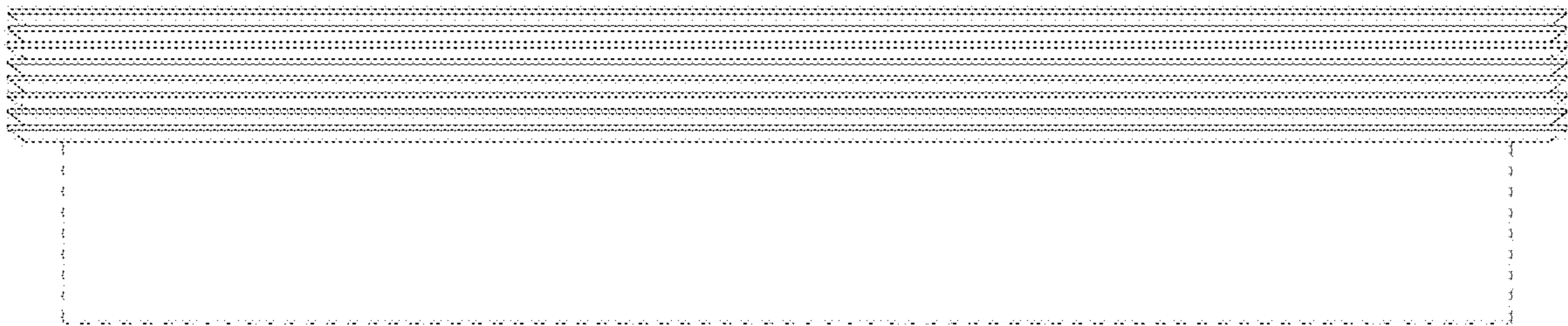

1.8

