



US00D910153S

(12) **United States Design Patent** (10) **Patent No.:** **US D910,153 S**  
**Schoenherr et al.** (45) **Date of Patent:** **\*\* \*Feb. 9, 2021**

(54) **SHOWER CONTROL**

D813,993 S \* 3/2018 Schoenherr ..... D23/254  
D816,190 S \* 4/2018 Schoenherr ..... D23/254  
D817,459 S \* 5/2018 Schoenherr ..... D23/254

(71) Applicant: **Hansgrohe SE**, Schiltach (DE)

(72) Inventors: **Tom Schoenherr**, Stuttgart (DE);  
**Matthias Oesterle**, Winterbach (DE)

(73) Assignee: **Hansgrohe SE**, Schiltach (DE)

(\*) Notice: This patent is subject to a terminal disclaimer.

(\*\*) Term: **15 Years**

(21) Appl. No.: **29/693,402**

(22) Filed: **Jun. 3, 2019**

(30) **Foreign Application Priority Data**

Dec. 4, 2018 (EM) ..... 005843083-0023

(51) **LOC (13) Cl.** ..... **23-01**

(52) **U.S. Cl.**  
USPC ..... **D23/254**

(58) **Field of Classification Search**  
USPC ..... D23/250, 252, 254, 238–243, 249;  
D8/307–308, 353  
CPC ..... E03C 1/0408; E03C 1/09; E03C 1/042;  
E03C 1/0412  
See application file for complete search history.

(56) **References Cited**

**U.S. PATENT DOCUMENTS**

D725,235 S \* 3/2015 Barber ..... D23/254  
D761,388 S \* 7/2016 Schoenherr ..... D23/250

**FOREIGN PATENT DOCUMENTS**

EM 002334011-0014 5/2016  
EM 003231604-0004 1/2017  
EM 005515749-0018 8/2018

\* cited by examiner

*Primary Examiner* — Robert A Delehanty

(74) *Attorney, Agent, or Firm* — Lora J. Graentzdoerffer

(57) **CLAIM**

The ornamental design for a shower control, as shown and described.

**DESCRIPTION**

FIG. 1 is a perspective view of a shower control showing our design;  
FIG. 2 is a front elevation view;  
FIG. 3 is a rear elevation view;  
FIG. 4 is a side elevation view;  
FIG. 5 is a top plan view; and,  
FIG. 6 is a bottom plan view.  
The broken-line disclosures in the view represents portions of the shower control in which the claimed design is embodied, but which forms no part of the claimed design.

**1 Claim, 6 Drawing Sheets**

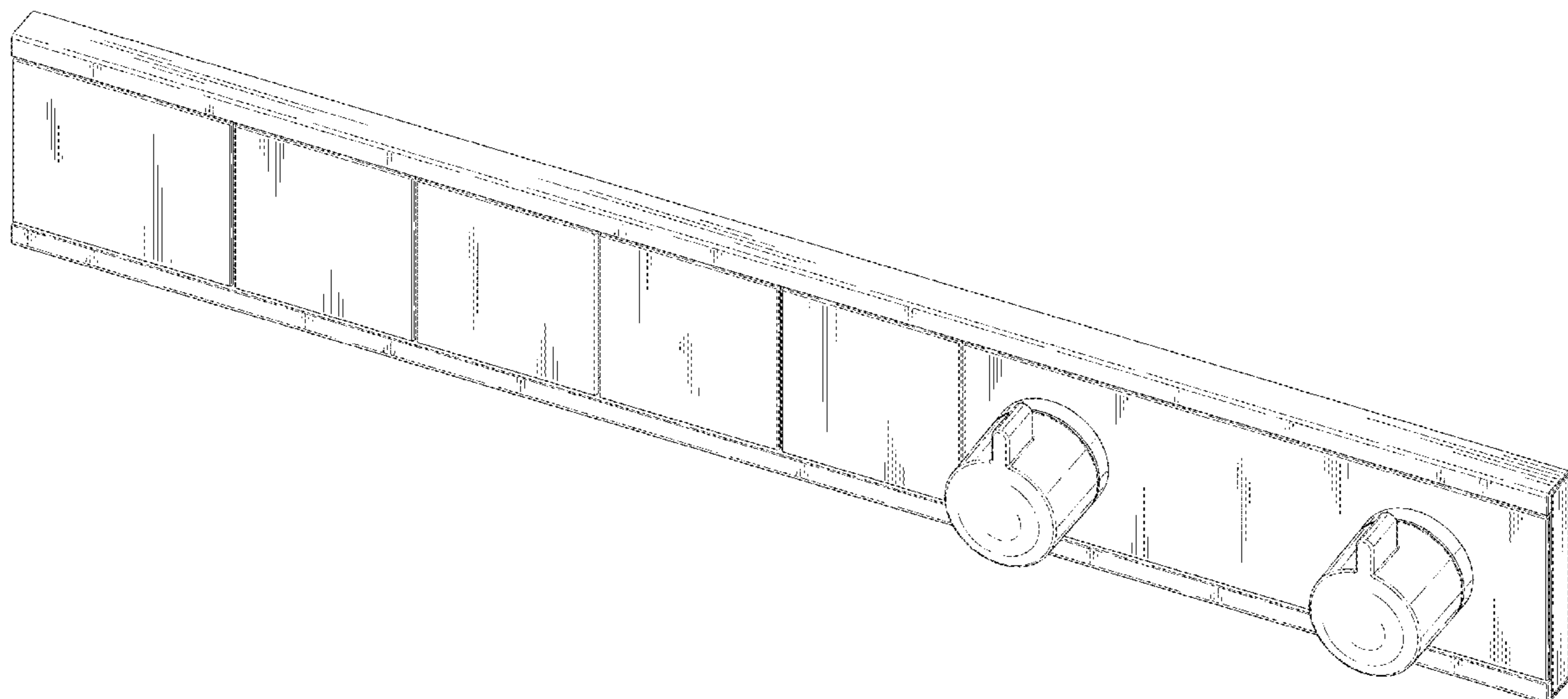

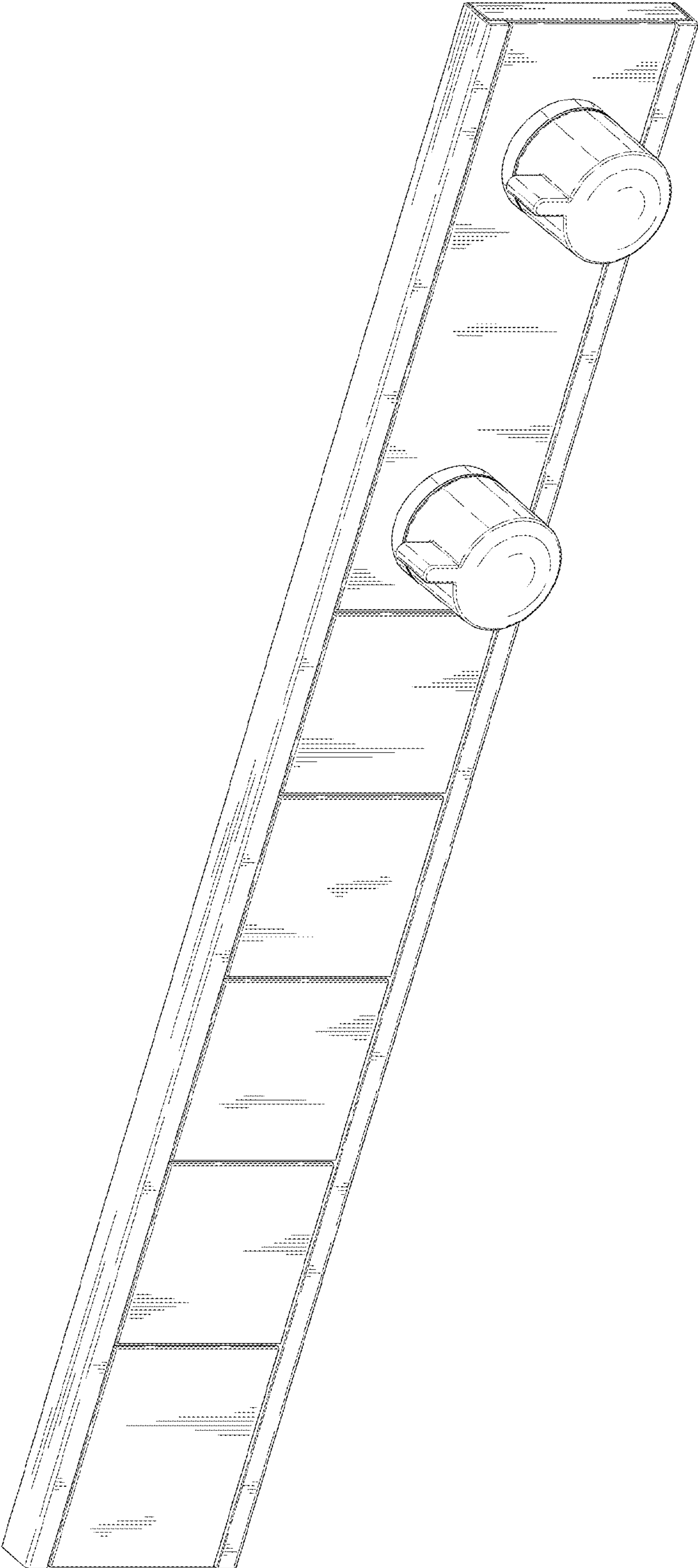

FIG. 1

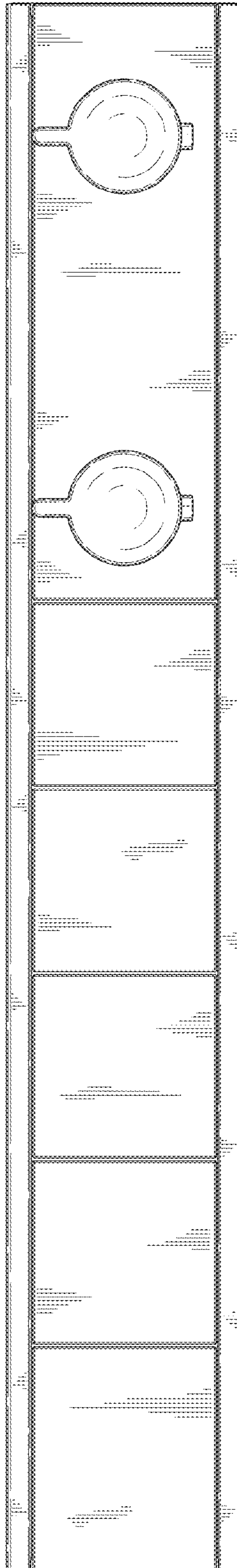

FIG. 2

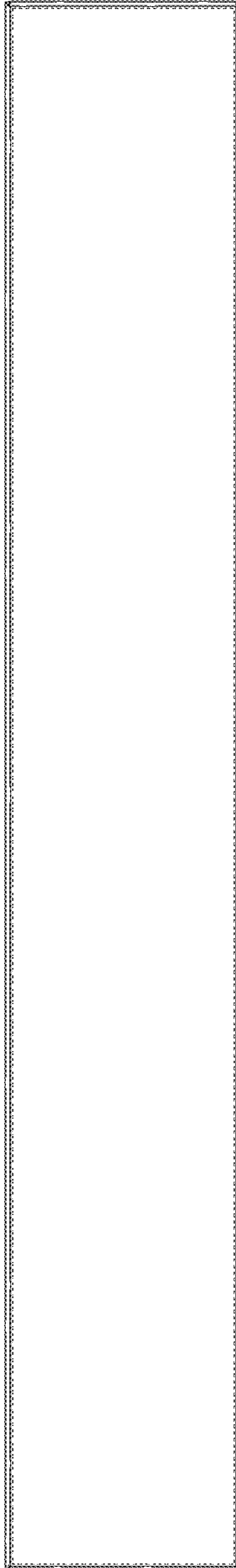
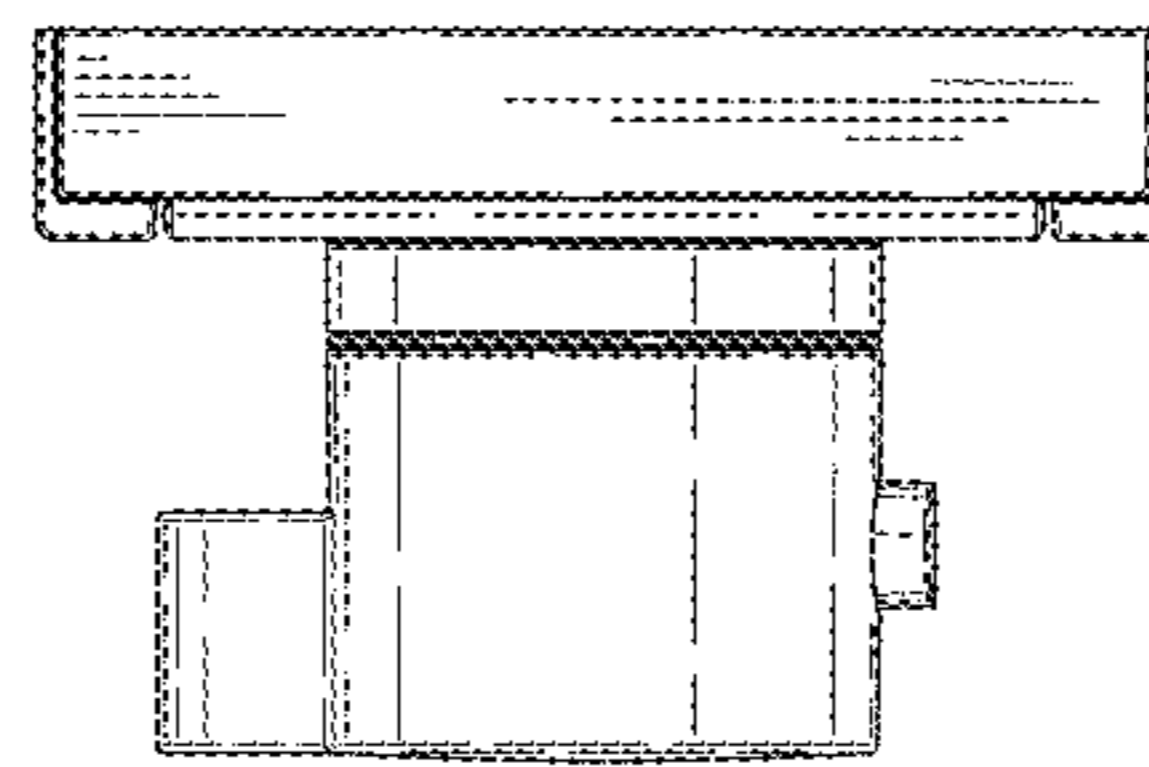

FIG. 3

FIG. 4



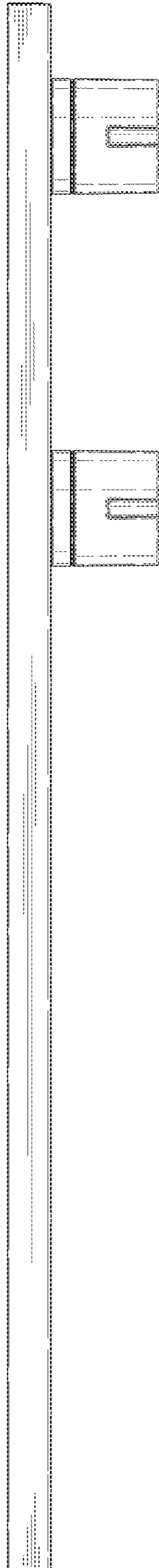

FIG. 5



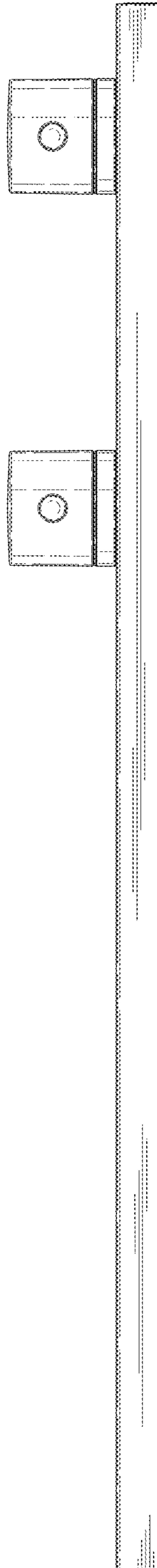

FIG. 6