



US00D910141S

(12) **United States Design Patent**
Stadler

(10) **Patent No.:** **US D910,141 S**

(45) **Date of Patent:** **** Feb. 9, 2021**

(54) **SEPARATION TOOL**

(71) Applicant: **Gary D Stadler**, Rancho Sante Fe, CA
(US)

(72) Inventor: **Gary D Stadler**, Rancho Sante Fe, CA
(US)

(**) Term: **15 Years**

(21) Appl. No.: **29/665,059**

(22) Filed: **Sep. 29, 2018**

(51) **LOC (13) Cl.** **23-01**

(52) **U.S. Cl.**
USPC **D23/207**

(58) **Field of Classification Search**
USPC D23/206, 207, 268
CPC B01D 1/305; B01D 5/0063; B01B 1/08;
G01N 25/145; Y10S 203/02
See application file for complete search history.

(56) **References Cited**

U.S. PATENT DOCUMENTS

2,425,669	A *	8/1947	Brock	165/111
2,759,559	A *	8/1956	Bourne	B01D 1/305 55/345
3,907,683	A *	9/1975	Gilmont	B01B 1/08 202/177
4,121,779	A *	10/1978	Mills	A47J 43/22 209/235
D254,441	S *	3/1980	Lemoine	D23/207
4,235,677	A *	11/1980	Karamian	B01D 5/0006 137/251.1
5,156,812	A *	10/1992	Killough	B01D 11/0219 202/168
5,571,385	A *	11/1996	Faur	C02F 1/04 203/10

D595,391	S *	6/2009	Weltman	C02F 1/04 D23/268
D805,599	S *	12/2017	Kremerman	B01D 11/0219 D23/207
D849,184	S *	5/2019	Kremerman	B01D 5/0006 D23/207
D855,754	S *	8/2019	Maibach, Jr.	B01B 1/08 D23/207
D862,640	S *	10/2019	Maibach, Jr.	D23/207

* cited by examiner

Primary Examiner — Sheryl Lane

Assistant Examiner — Calvin E Vansant

(74) *Attorney, Agent, or Firm* — CK IP Law

(57) **CLAIM**

I claim the ornamental design for a separation tool, as shown and described.

DESCRIPTION

FIG. 1 is a front perspective view of a first embodiment of a separation tool;
 FIG. 2 is a back view thereof;
 FIG. 3 is a front view thereof;
 FIG. 4 is a right view thereof;
 FIG. 5 is a left view thereof;
 FIG. 6 is a top view thereof;
 FIG. 7 is a bottom view thereof;
 FIG. 8 is a front perspective view of a second embodiment of a separation tool.
 FIG. 9 is a back view thereof;
 FIG. 10 is a right view thereof;
 FIG. 11 is a left view thereof;
 FIG. 12 is a top view thereof; and,
 FIG. 13 is a bottom view thereof.
 The portions of the article shown in broken lines form no part of the claimed design.

1 Claim, 11 Drawing Sheets

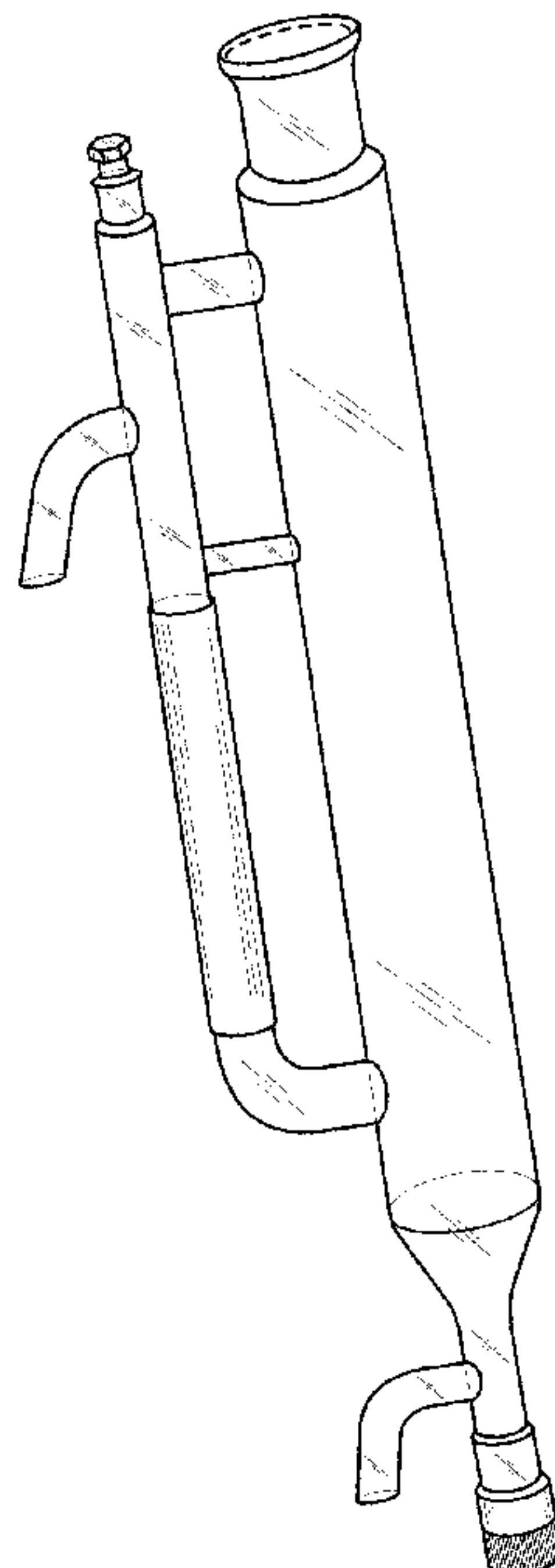

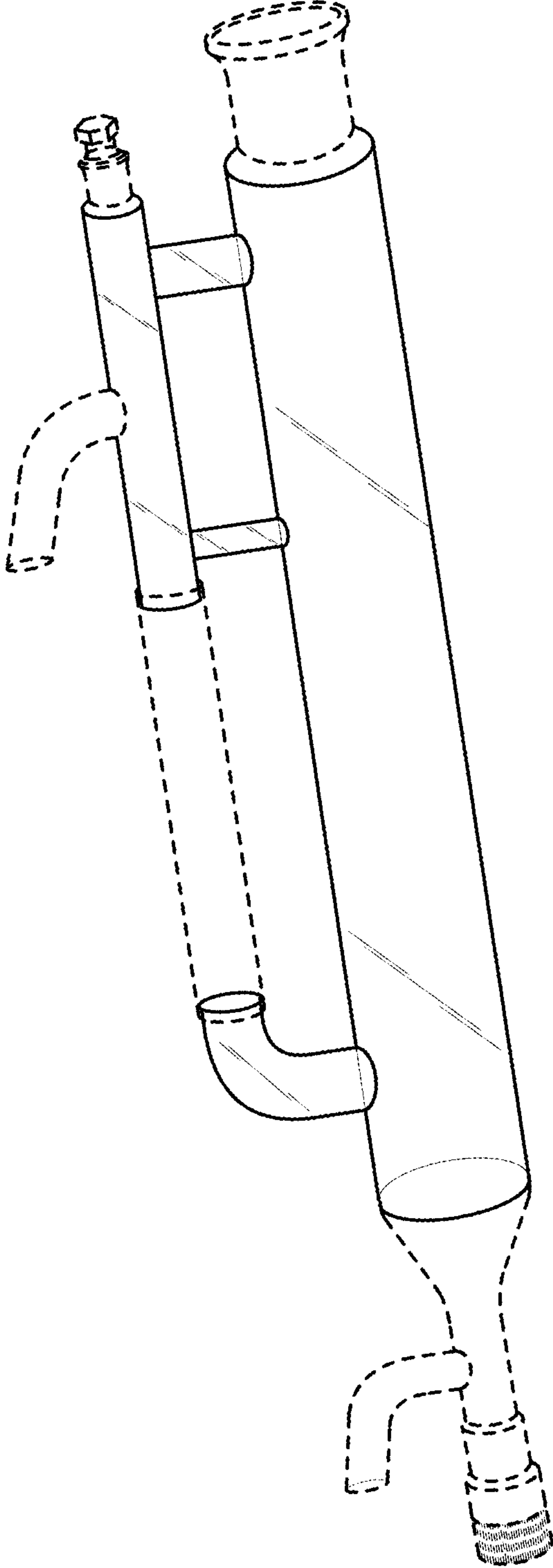

FIG. 1

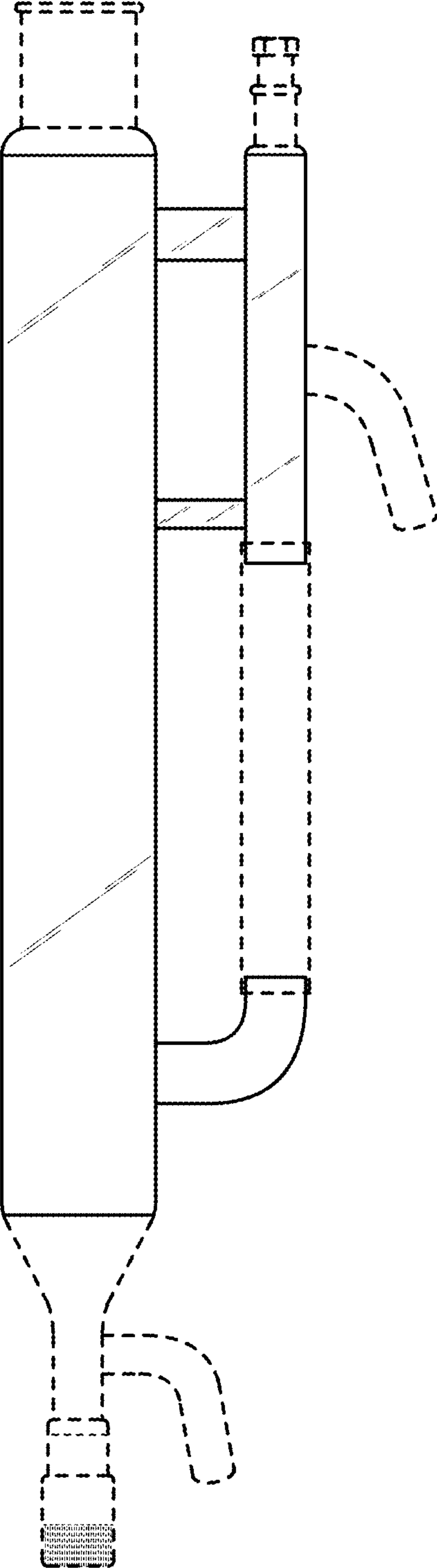

FIG. 2

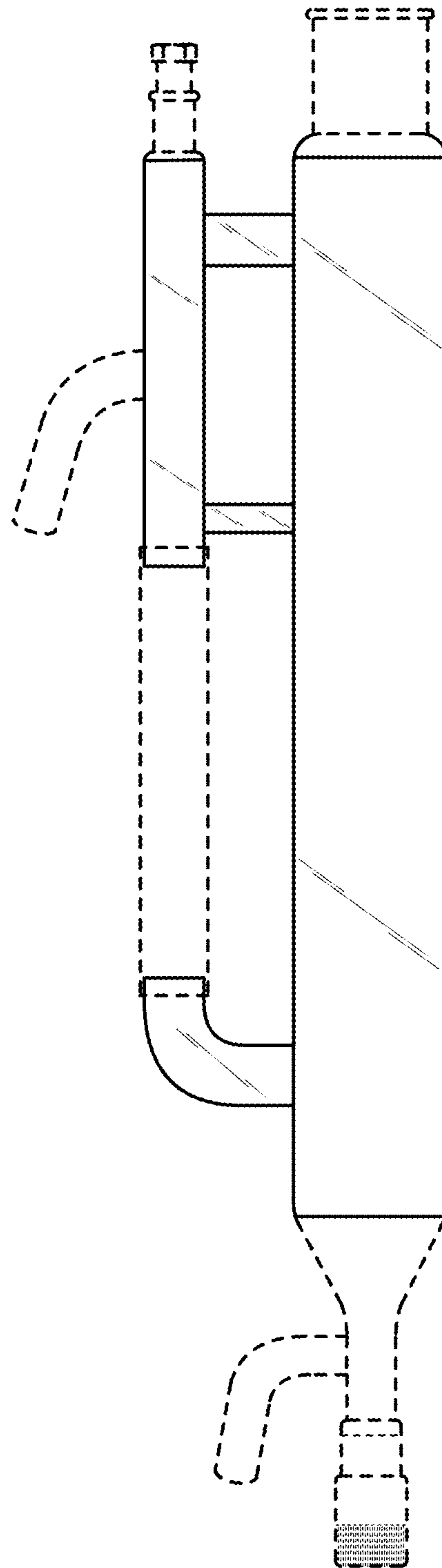

FIG. 3

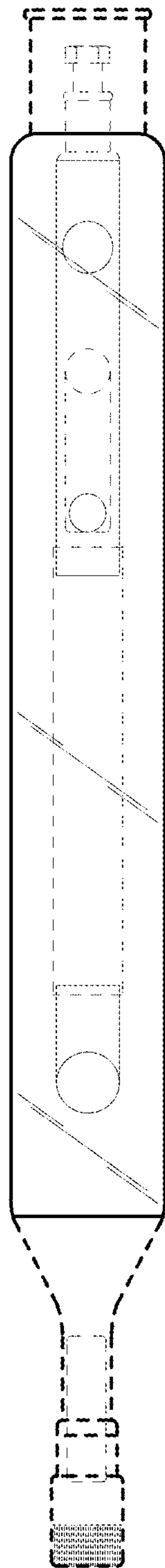

FIG. 4

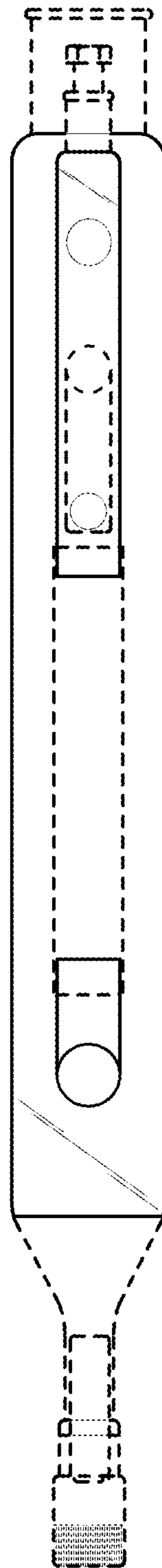

FIG. 5

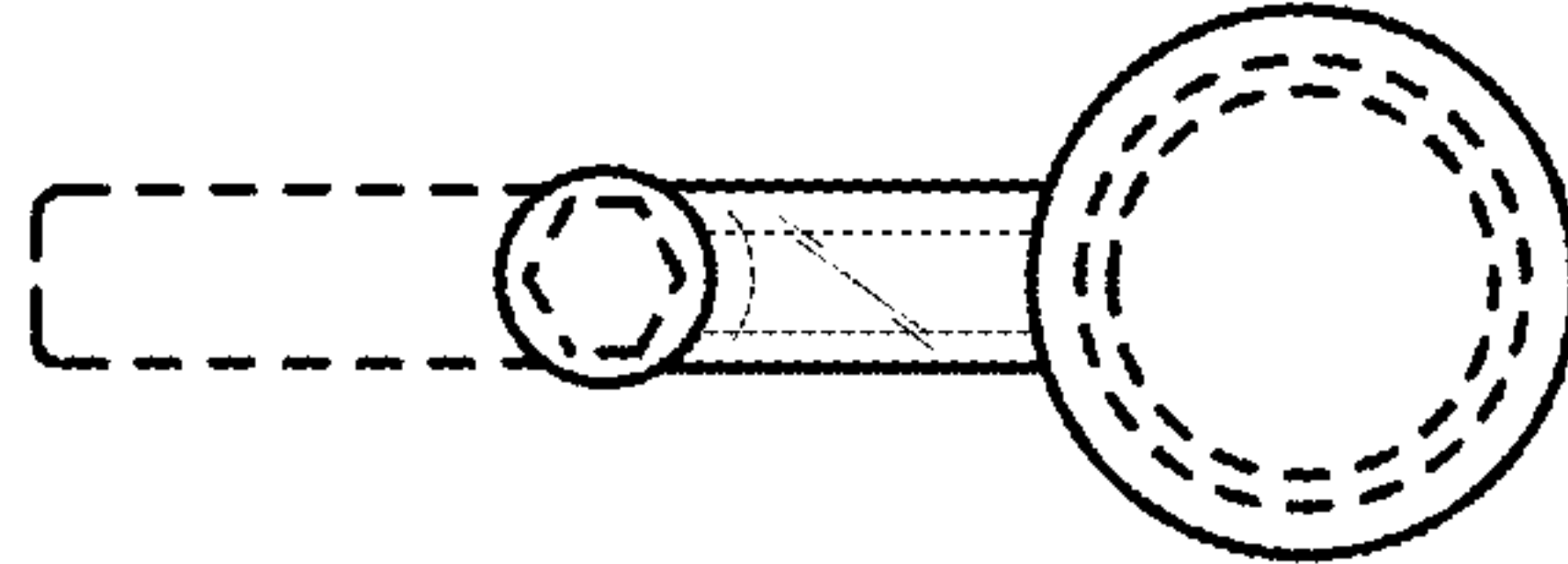

FIG. 6

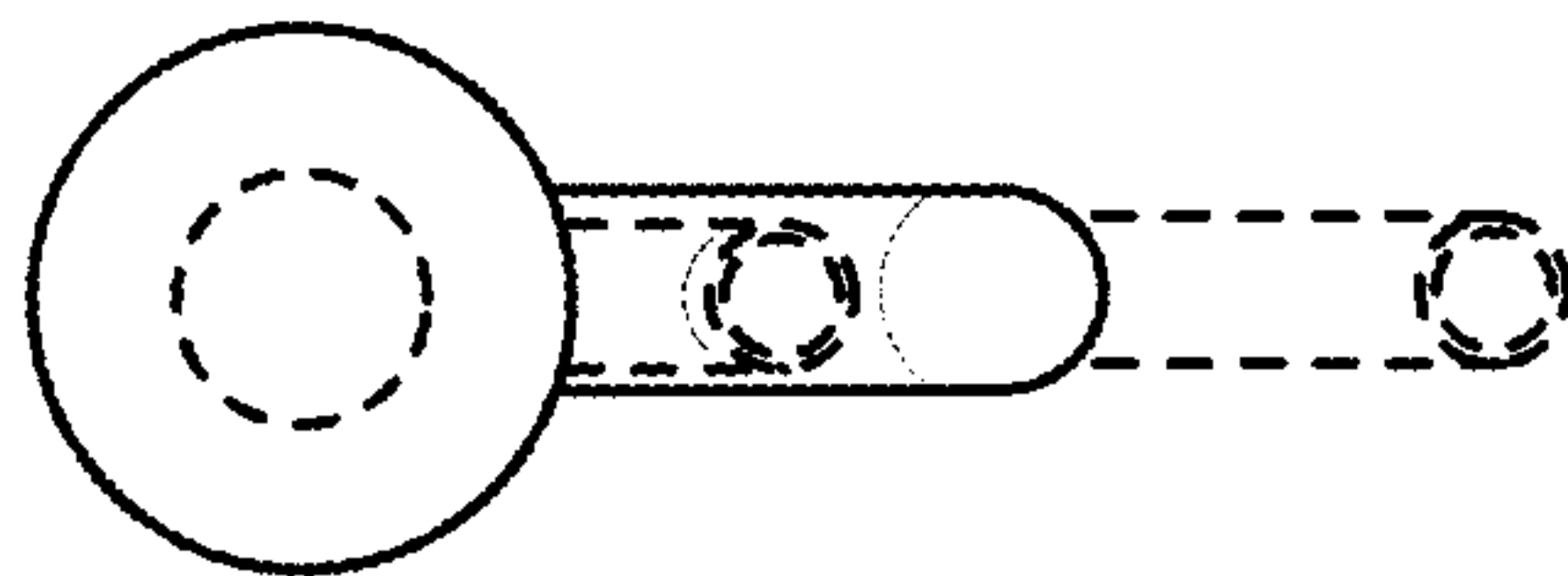

FIG. 7

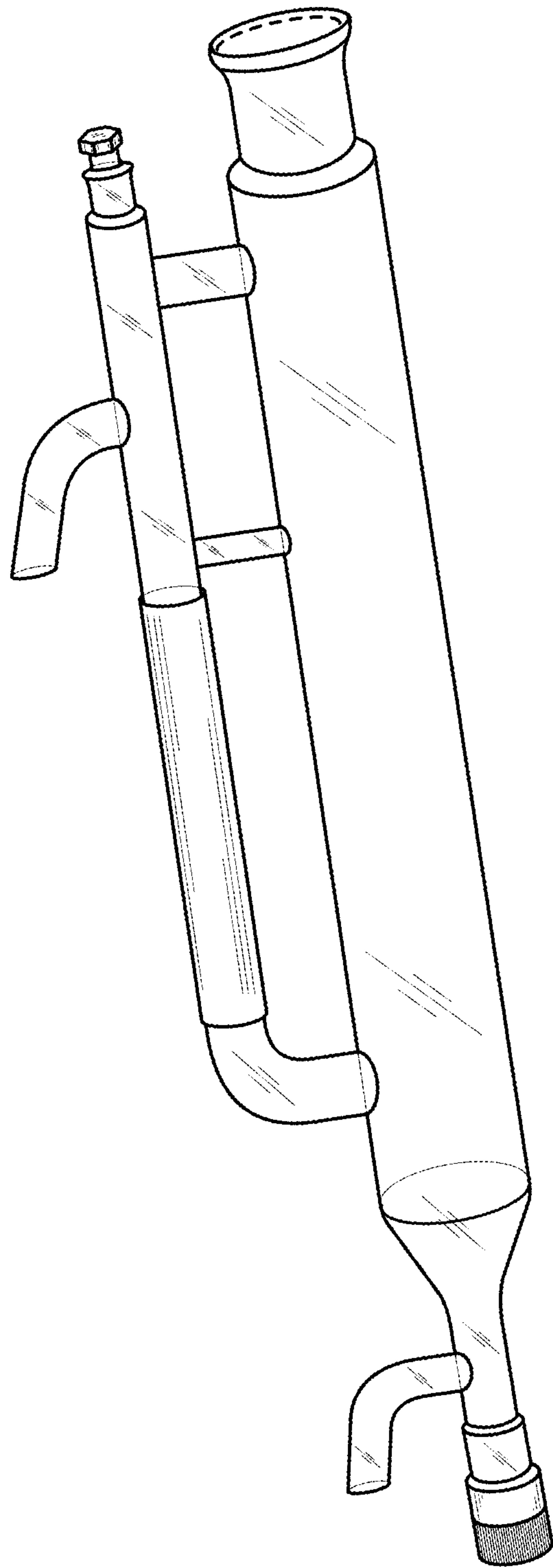

FIG. 8

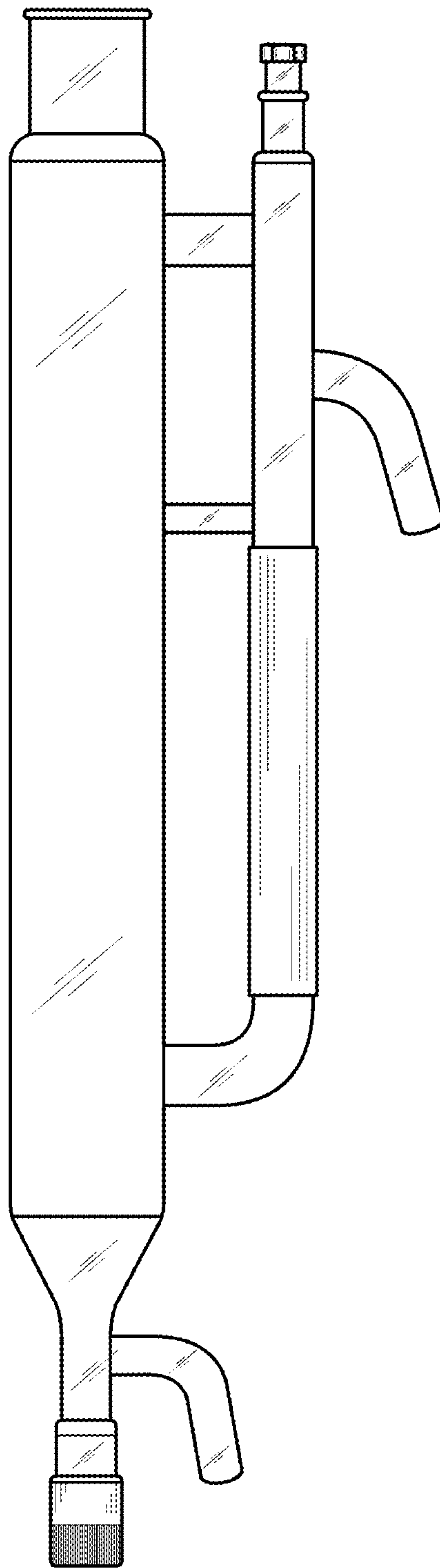

FIG. 9

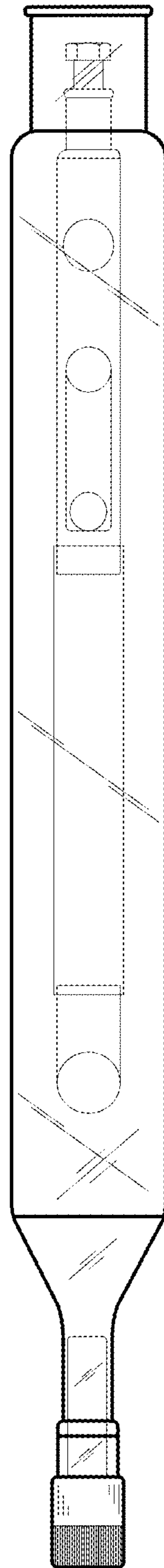

FIG. 10

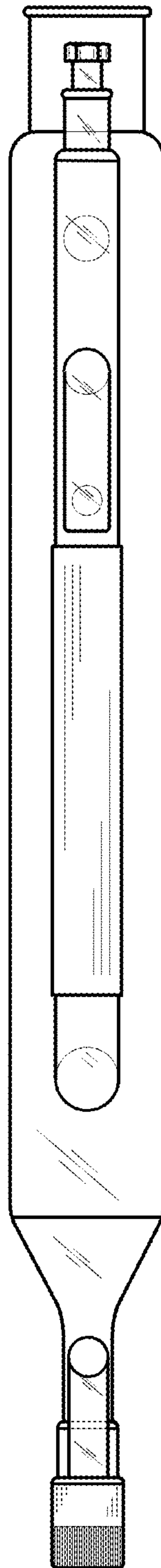

FIG. 11

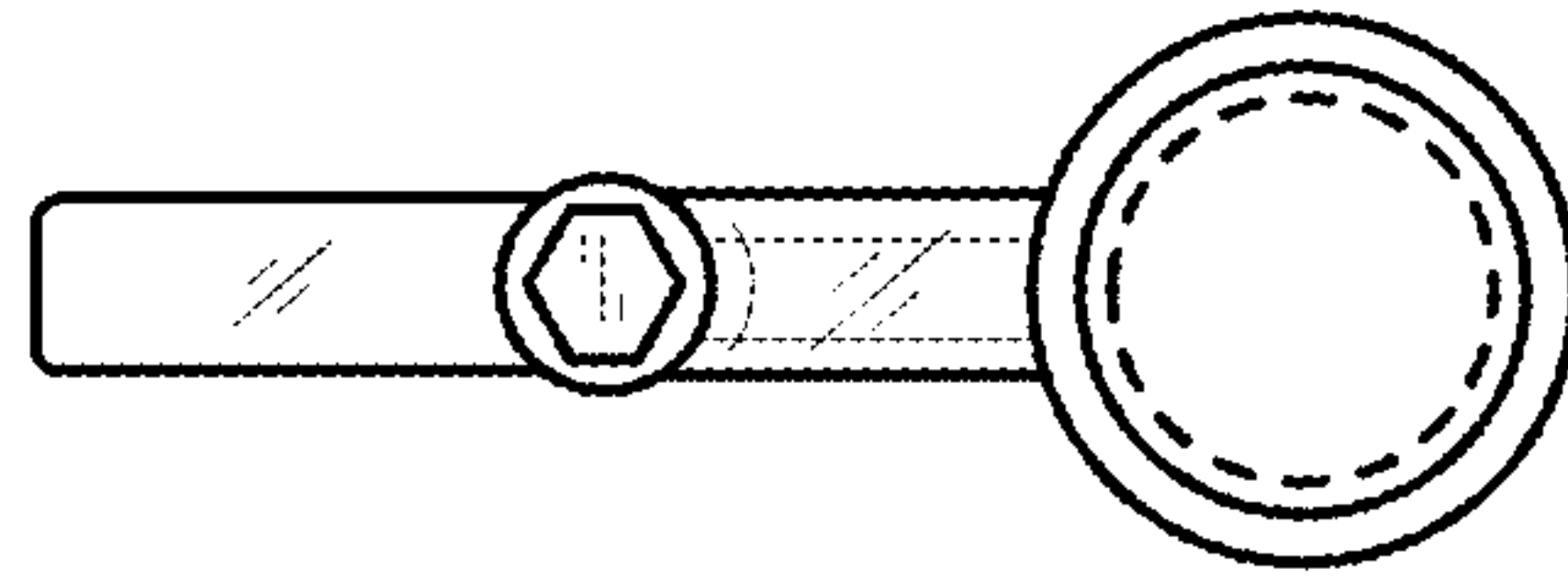

FIG. 12

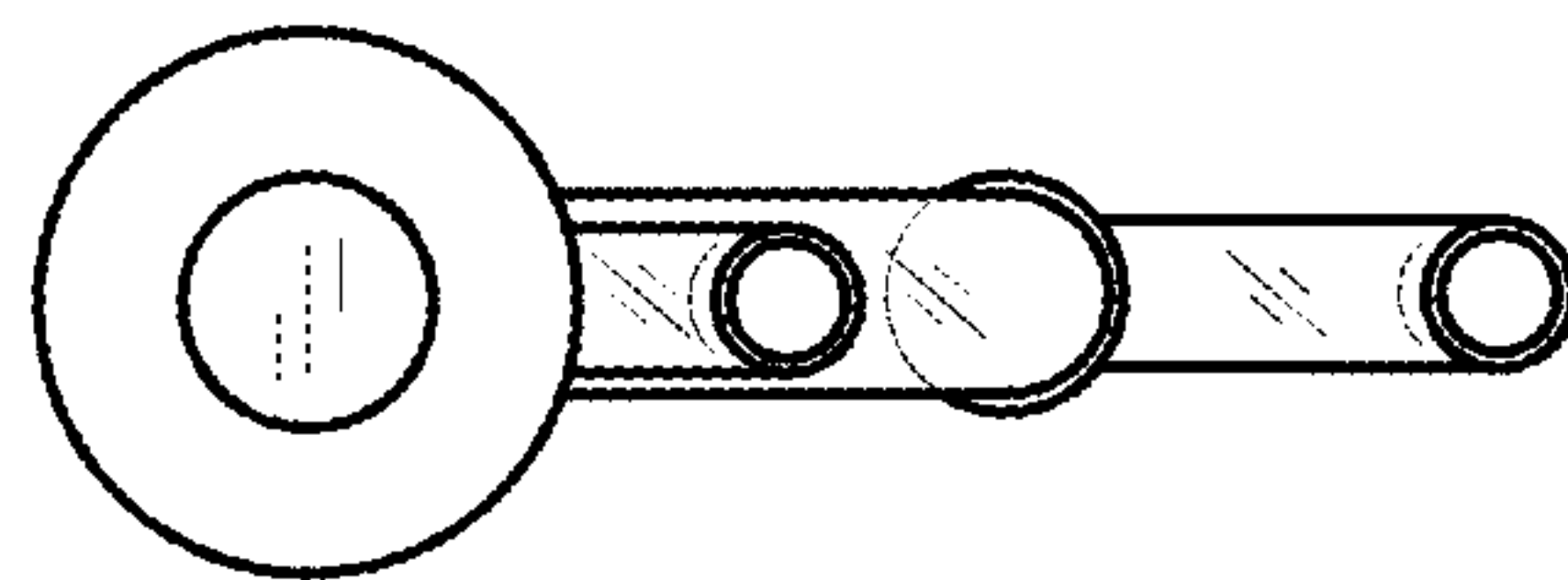

FIG. 13