



US00D910003S

(12) **United States Design Patent** (10) **Patent No.:** **US D910,003 S**  
**Seo** (45) **Date of Patent:** **\*\* Feb. 9, 2021**

(54) **MOBILE COMMUNICATION TERMINAL**

(74) *Attorney, Agent, or Firm* — McAndrews Held & Malloy, Ltd.

(71) Applicant: **Samsung Electronics Co., Ltd.**,  
Suwon-si (KR)

(57) **CLAIM**

(72) Inventor: **Jaehun Seo**, Suwon-si (KR)

The ornamental design for a mobile communication terminal, as shown and described.

(73) Assignee: **SAMSUNG ELECTRONICS CO., LTD.**, Suwon-si (KR)

**DESCRIPTION**

(\*\*) Term: **15 Years**

FIG. 1 is a front perspective view of a mobile communication terminal showing my new design according to a first embodiment;

(21) Appl. No.: **29/693,613**

FIG. 2 is a front elevation view thereof;

(22) Filed: **Jun. 4, 2019**

FIG. 3 is a rear elevation view thereof;

(30) **Foreign Application Priority Data**

FIG. 4 is a left side elevation view thereof;

Dec. 14, 2018 (KR) ..... 30-2018-0059228

FIG. 5 is a right side elevation view thereof;

(51) **LOC (13) Cl.** ..... **14-03**

FIG. 6 is a top plan view thereof;

(52) **U.S. Cl.**

FIG. 7 is a bottom plan view thereof;

USPC ..... **D14/248**

FIG. 8 is a front perspective view of a mobile communication terminal showing my new design according to a second embodiment;

(58) **Field of Classification Search**

FIG. 9 is a front elevation view thereof;

USPC ..... D14/138 G, 138 AD, 138 AB, 248, 341,  
D14/371, 374, 138 R, 138 AA, 138 AC,  
D14/138 C, 247

FIG. 10 is a rear elevation view thereof;

(Continued)

FIG. 11 is a left side elevation view thereof;

(56) **References Cited**

FIG. 12 is a right side elevation view thereof;

U.S. PATENT DOCUMENTS

FIG. 13 is a top plan view thereof;

D529,045 S \* 9/2006 Shin ..... D14/203.7

FIG. 14 is a bottom plan view thereof;

D548,713 S \* 8/2007 Lee ..... D14/138 AD

FIG. 15 is a front perspective view of a mobile communication terminal showing my new design according to a third embodiment;

(Continued)

FIG. 16 is a front elevation view thereof;

OTHER PUBLICATIONS

Samsung Galaxy S10 5G, announced Feb. 2019, [online], [retrieved on May 22, 2019]. Retrieved from Internet ,<URL: [http:// www.gsmarena.com](http://www.gsmarena.com)>.\*

FIG. 17 is a rear elevation view thereof;

(Continued)

FIG. 18 is a left side elevation view thereof;

*Primary Examiner* — Bridget L Eland

FIG. 19 is a right side elevation view thereof;

FIG. 20 is a top plan view thereof;

FIG. 21 is a bottom plan view thereof;

FIG. 22 is a front perspective view of a mobile communication terminal showing my new design according to a fourth embodiment;

FIG. 23 is a front elevation view thereof;

FIG. 24 is a rear elevation view thereof;

FIG. 25 is a left side elevation view thereof;

FIG. 26 is a right side elevation view thereof;

(Continued)

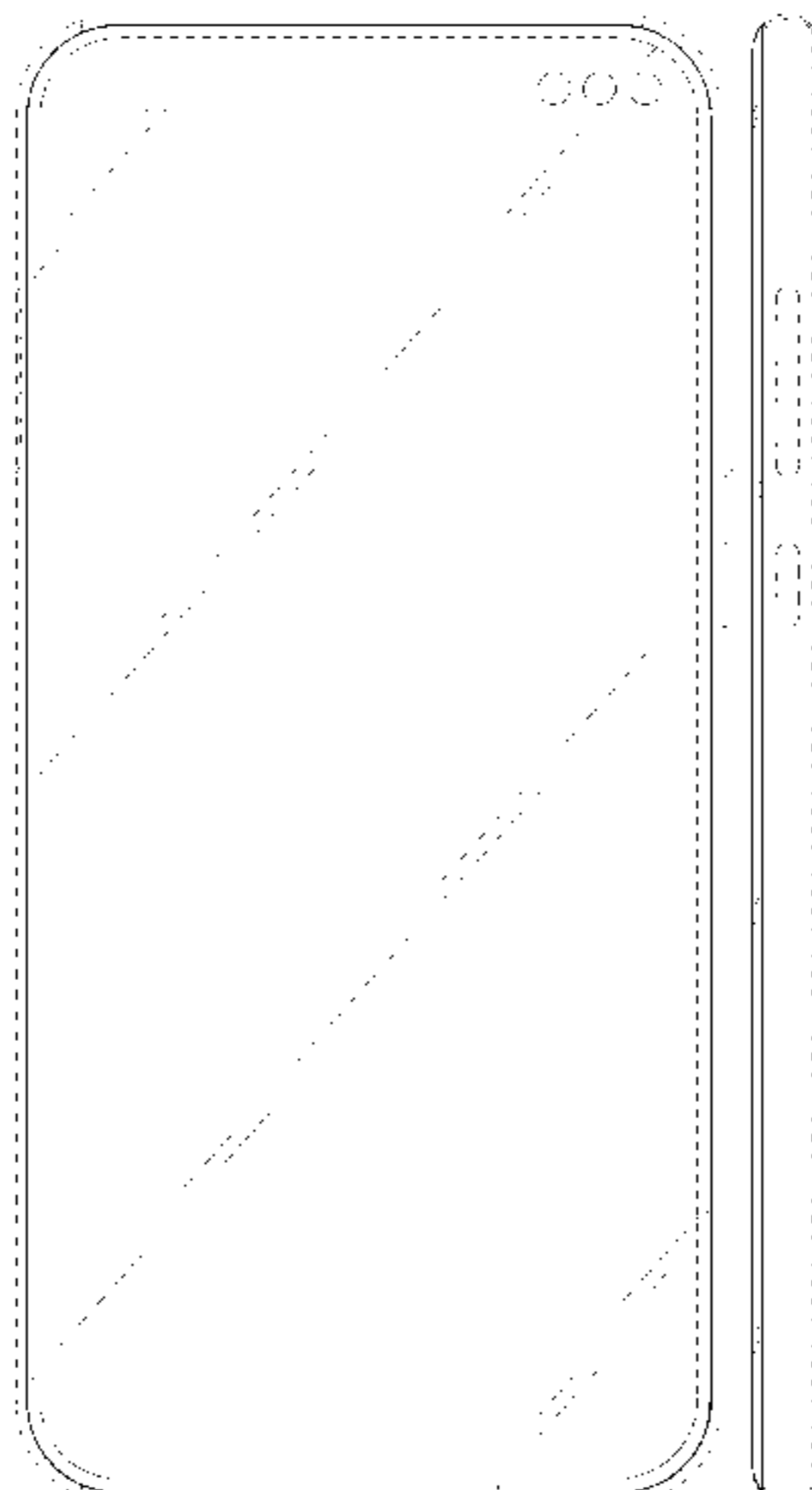

FIG. 27 is a top plan view thereof;  
 FIG. 28 is a bottom plan view thereof;  
 FIG. 29 is a front perspective view of a mobile communication terminal showing my new design according to a fifth embodiment;  
 FIG. 30 is a front elevation view thereof;  
 FIG. 31 is a rear elevation view thereof;  
 FIG. 32 is a left side elevation view thereof;  
 FIG. 33 is a right side elevation view thereof;  
 FIG. 34 is a top plan view thereof;  
 FIG. 35 is a bottom plan view thereof;  
 FIG. 36 is a front perspective view of a mobile communication terminal showing my new design according to a sixth embodiment;  
 FIG. 37 is a front elevation view thereof;  
 FIG. 38 is a rear elevation view thereof;  
 FIG. 39 is a left side elevation view thereof;  
 FIG. 40 is a right side elevation view thereof;  
 FIG. 41 is a top plan view thereof; and,  
 FIG. 42 is a bottom plan view thereof.  
 The dashed broken lines in the figures depict portions of the mobile communication terminal that form no part of the claimed design.

D648,300	S	*	11/2011	Park	.....	D14/138	G
D652,008	S	*	1/2012	Kim	.....	D14/138	G
D687,404	S	*	8/2013	Yoshimura	.....	D14/138	G
D696,217	S	*	12/2013	Luo	.....	D14/138	G
D711,341	S	*	8/2014	Shin	.....	D14/138	G
D738,843	S	*	9/2015	Yoon	.....	D14/138	G
D765,068	S	*	8/2016	Min	.....	D14/248	
D775,125	S	*	12/2016	Yoshihara	.....	D14/341	
D784,281	S	*	4/2017	Ryu	.....	D14/138	G
D827,625	S	*	9/2018	Berneth	.....	D14/248	
D829,678	S	*	10/2018	Choe	.....	D14/138	G
D834,551	S	*	11/2018	Ryu	.....	D14/138	G
D859,382	S	*	9/2019	Yi	.....	D14/248	
D859,383	S	*	9/2019	Yi	.....	D14/248	
D863,245	S	*	10/2019	Yuan	.....	D14/138	G
D863,246	S	*	10/2019	Fan	.....	D14/138	AD
D865,732	S	*	11/2019	Park	.....	D14/248	
D865,733	S	*	11/2019	Park	.....	D14/248	
D865,735	S	*	11/2019	Park	.....	D14/248	
D865,737	S	*	11/2019	Park	.....	D14/248	
D876,415	S	*	2/2020	Yi	.....	D14/248	
D877,710	S	*	3/2020	Wu	.....	D14/138	G
D879,736	S	*	3/2020	Park	.....	D14/138	G
D892,780	S	*	8/2020	Park	.....	D14/248	
D894,858	S	*	9/2020	Park	.....	D14/138	G
D894,859	S	*	9/2020	Park	.....	D14/138	G
2019/0386696	A1	*	12/2019	Luo	.....	A45C	11/00

**1 Claim, 30 Drawing Sheets**

(58) **Field of Classification Search**  
 CPC ..... H04M 1/0202; H04M 1/0235; H04M 1/0237; H04M 1/0239; H04M 1/0266; H04M 1/0268; H04M 1/027; H04M 1/0295; H04M 1/02; H04M 1/0279; H04M 1/0283  
 See application file for complete search history.

(56) **References Cited**  
 U.S. PATENT DOCUMENTS

D558,720	S	*	1/2008	Lee	.....	D14/138	AD
D613,722	S	*	4/2010	Kaneta	.....	D14/138	G
D629,779	S	*	12/2010	Ahn	.....	D14/138	G
D629,780	S	*	12/2010	Woo	.....	D14/138	G
D638,814	S	*	5/2011	Sutherland	.....	D14/138	G
D648,299	S	*	11/2011	Kim	.....	D14/138	G

OTHER PUBLICATIONS

Samsung Galaxy S10+, announced Feb. 2019, [online], [retrieved on May 22, 2019]. Retrieved from Internet ,<URL: [http:// www.gsmarena.com](http://www.gsmarena.com)>.\*  
 Samsung Galaxy S10, announced Feb. 2019, [online], [retrieved on May 22, 219199]. Retrieved from Internet ,<URL: <http://www.gsmarena.com>>.\*  
 Samsung Galaxy S10e, announced Feb. 2019, [online], [retrieved on May 22, 2019]. Retrieved from Internet ,<URL: <http://www.gsmarena.com>>.\*  
 Nokia X71, announced Apr. 2019, [online], [retrieved on May 22, 2019]. Retrieved from Internet ,<URL: <http://www.gsmarena.com>>.\*  
 Motorola One Vision, announced May 2019, [online], [retrieved on May 22, 2019]. Retrieved from Internet ,<Url: [http:// www.gsmarena.com](http://www.gsmarena.com)>.\*  
 Honor 20, announced May 2019, [online], [retrieved on May 22, 2019]. Retrieved from Internet ,<URL: <http://www.gsmarena.com>>.\*

\* cited by examiner

FIG. 1

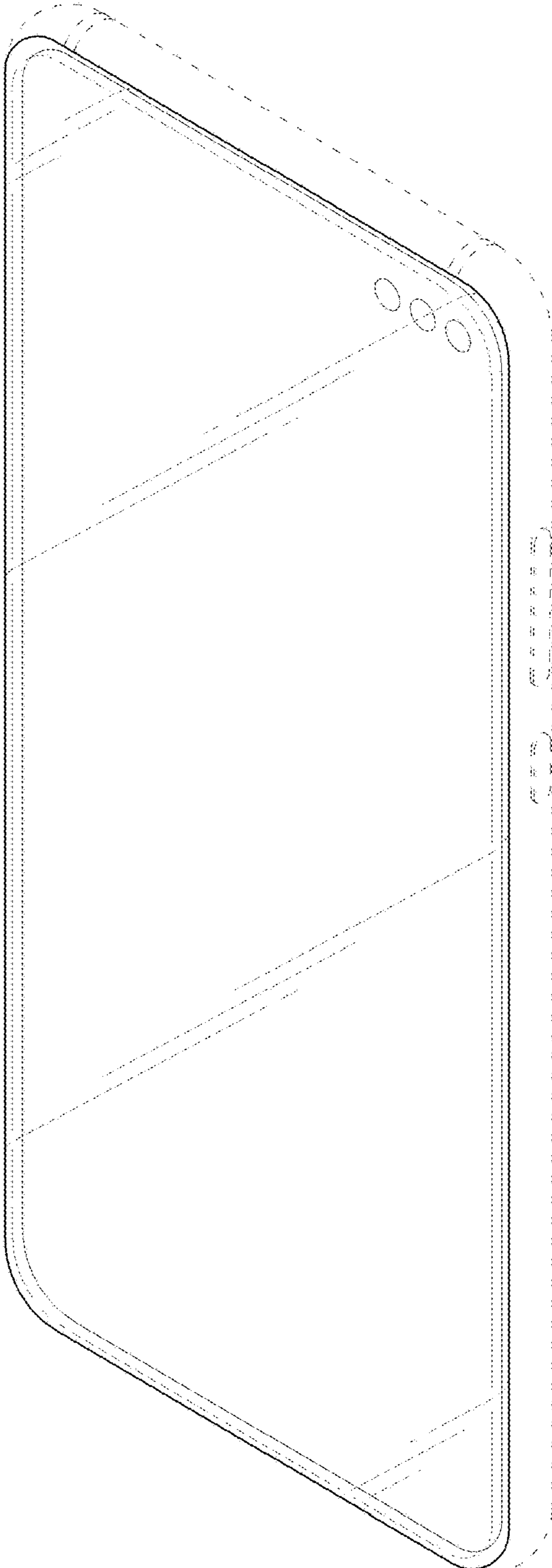

FIG. 2

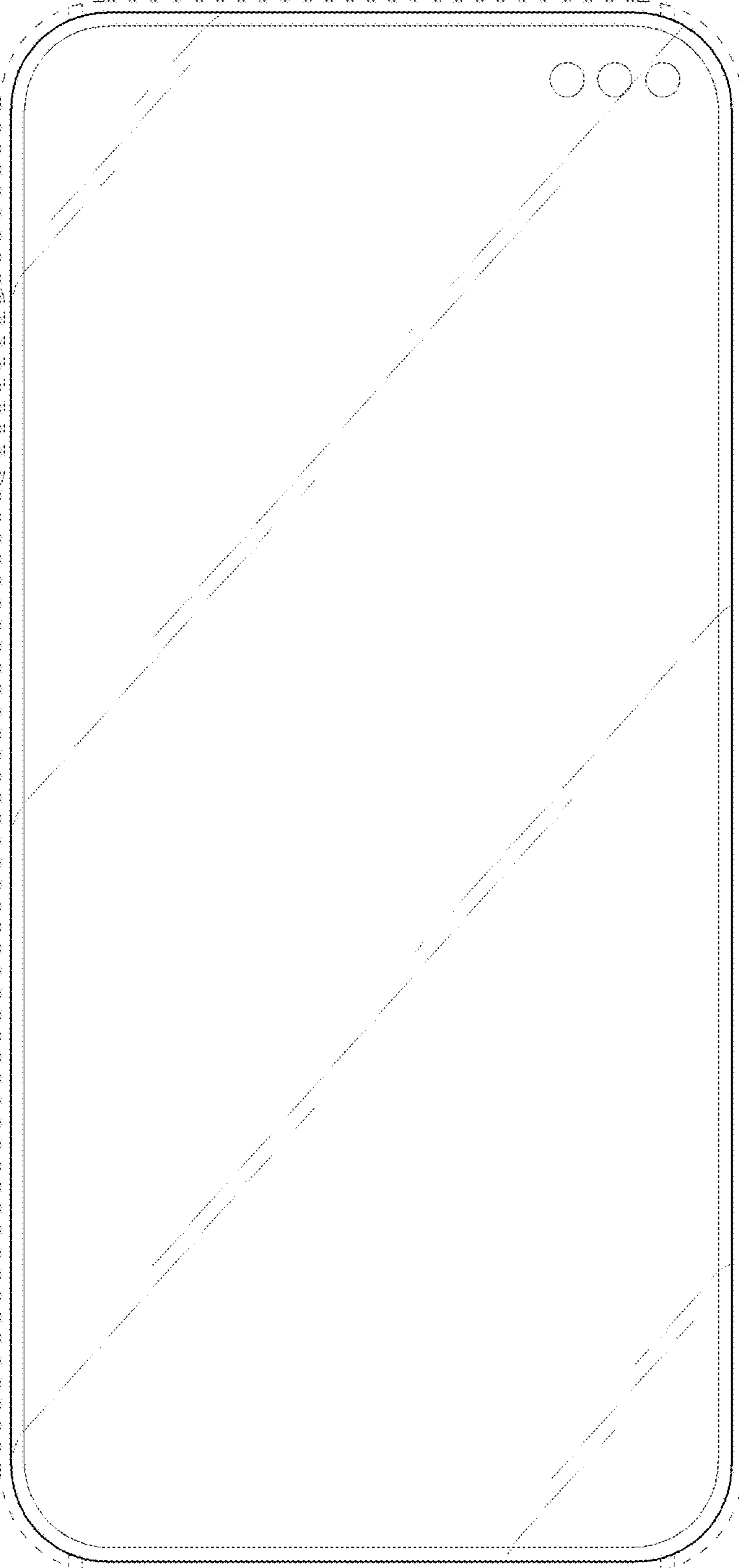

FIG. 3



FIG. 4

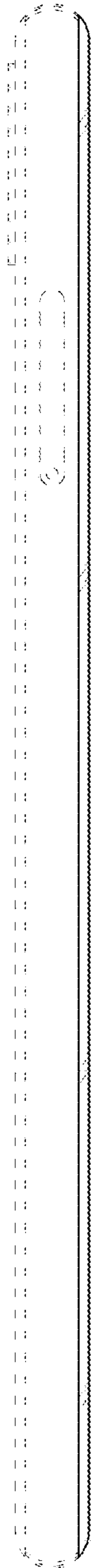

FIG. 5



FIG. 6



FIG. 7

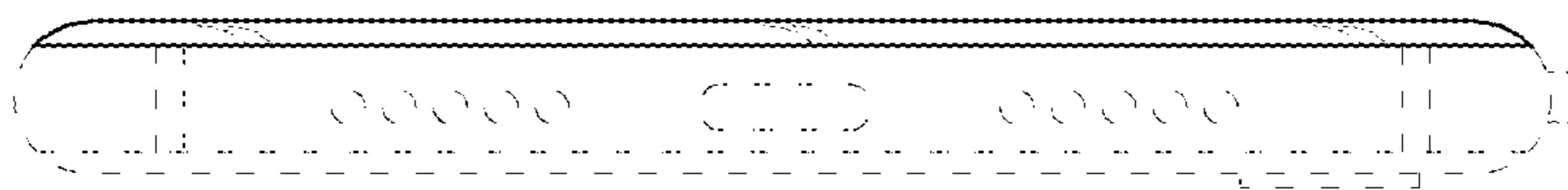

FIG. 8

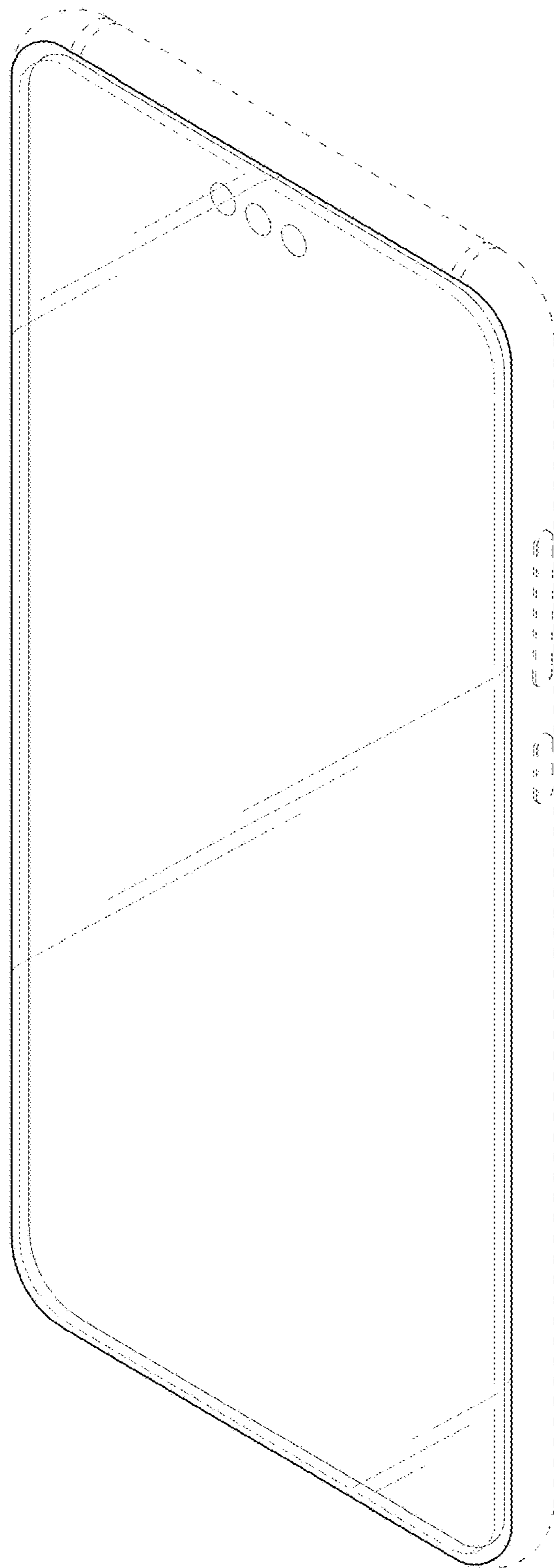



FIG. 9

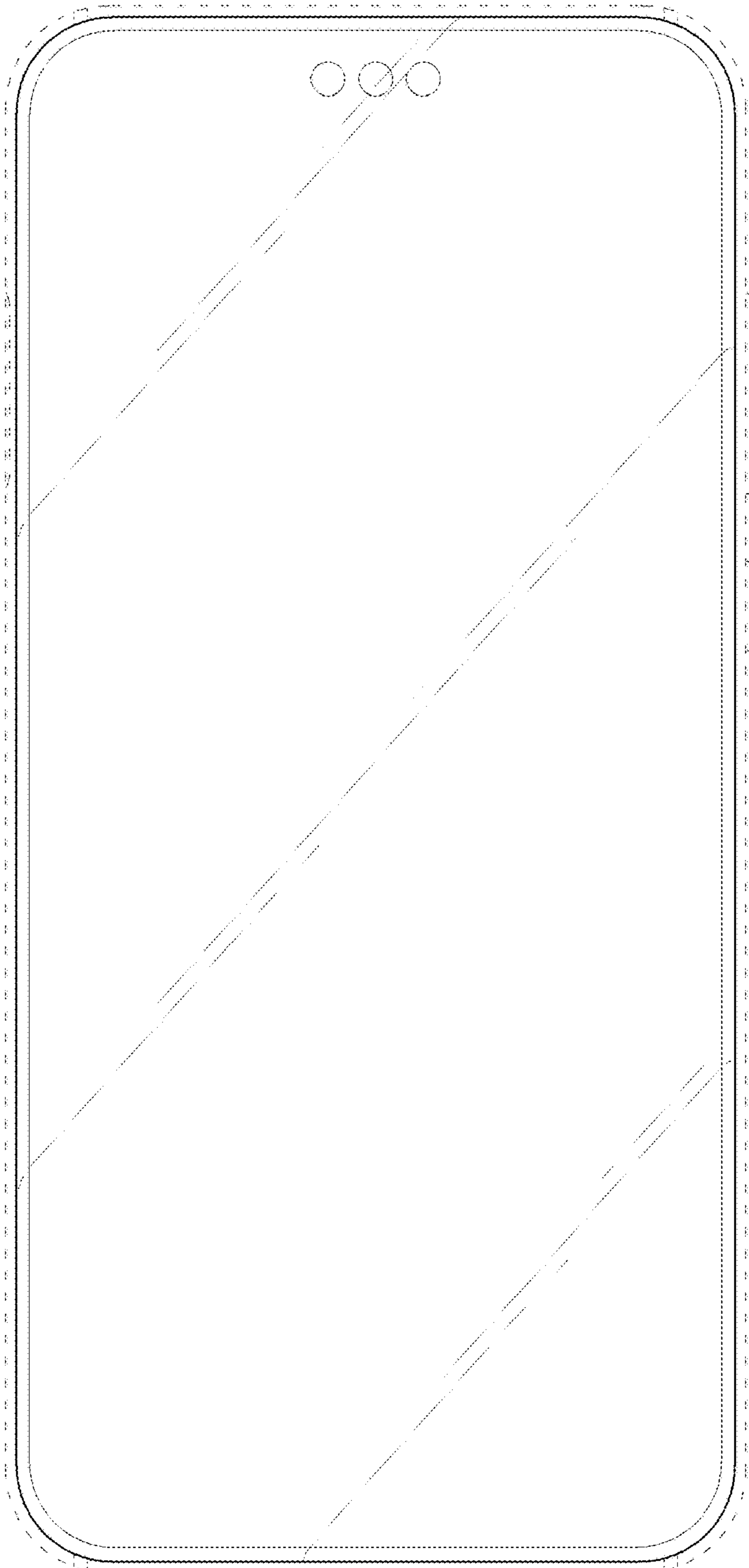

FIG. 10

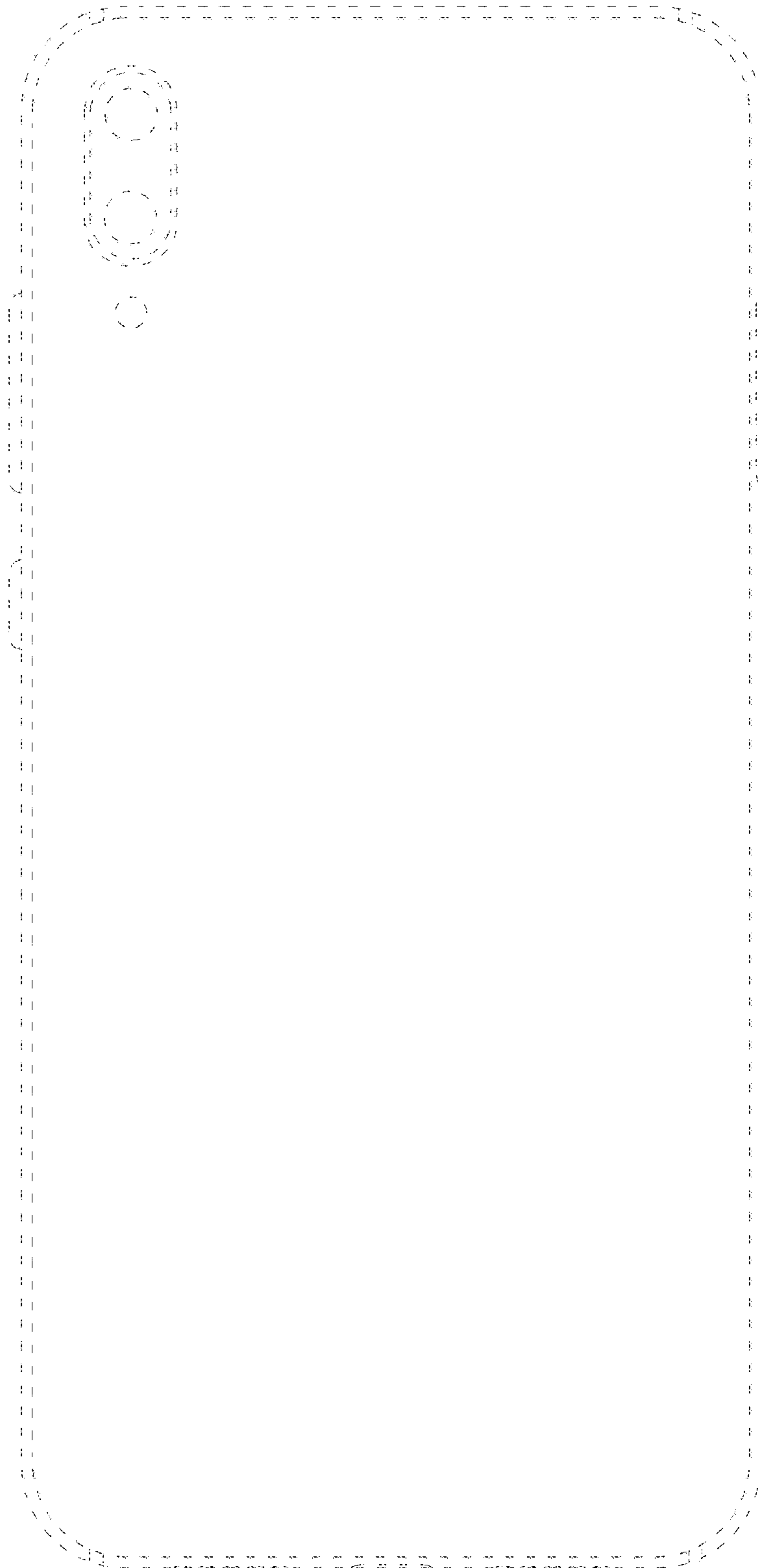

FIG. 11

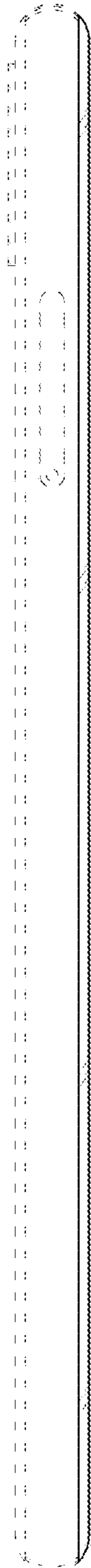

FIG. 12



FIG. 13



FIG. 14

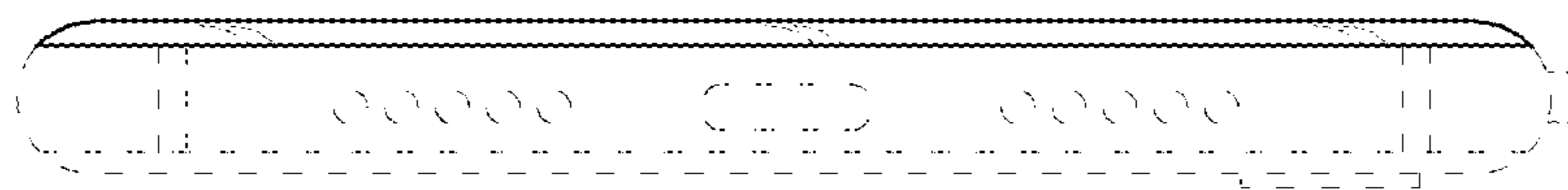

FIG. 15

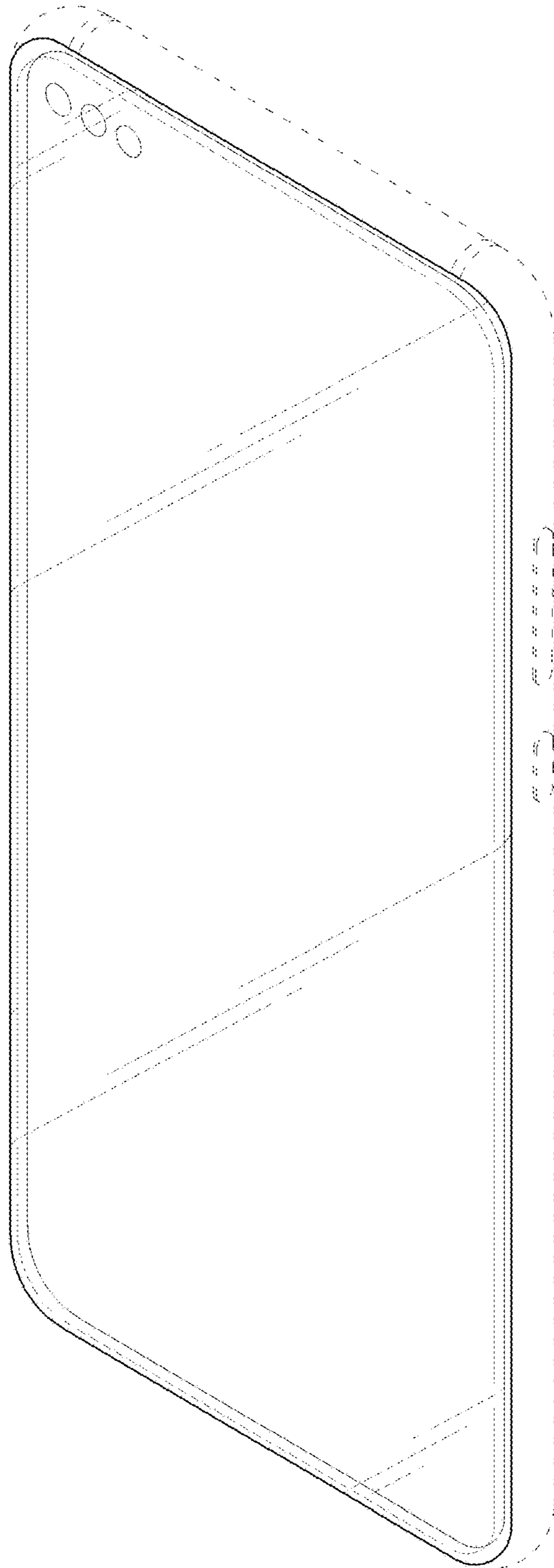

FIG. 16

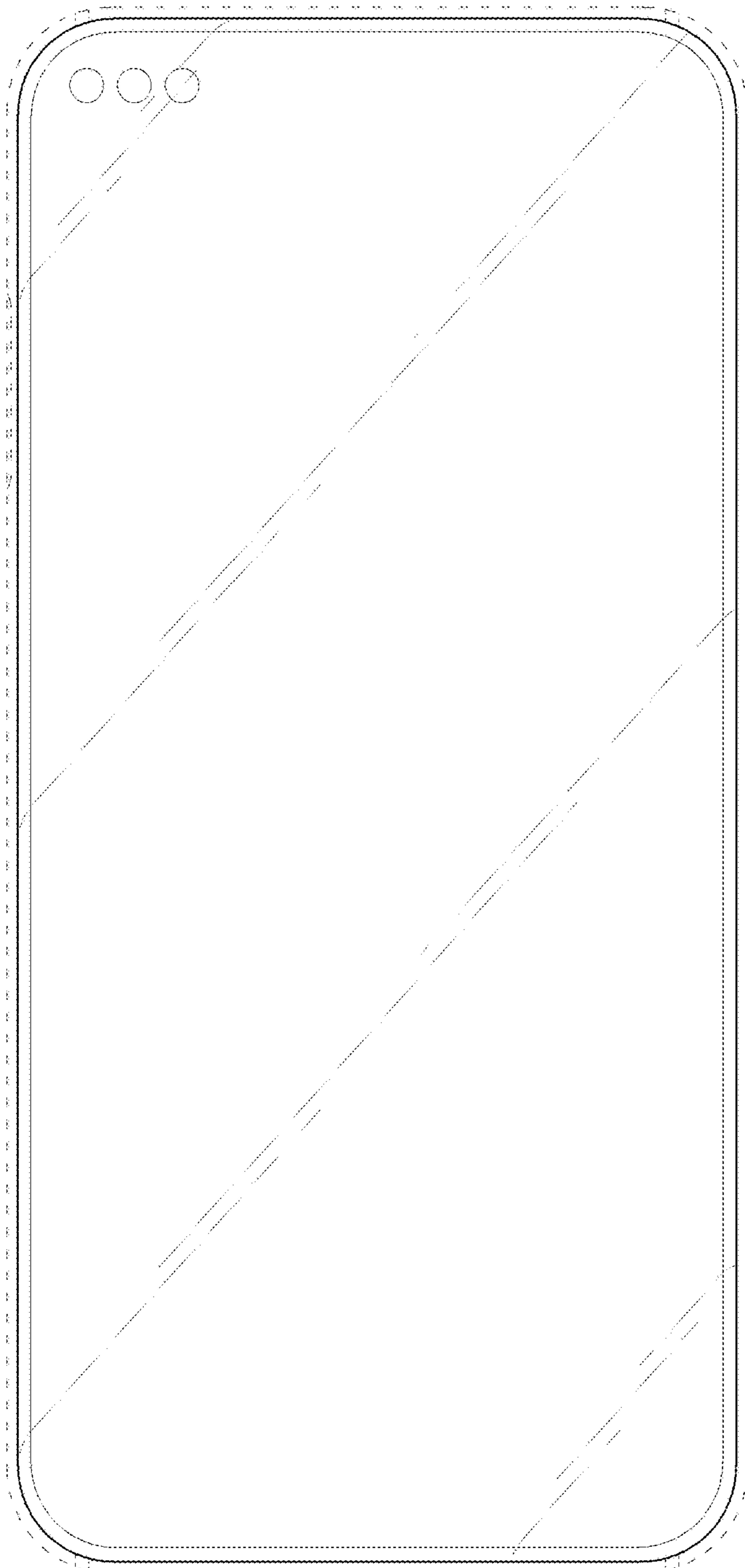

FIG. 17



FIG. 18

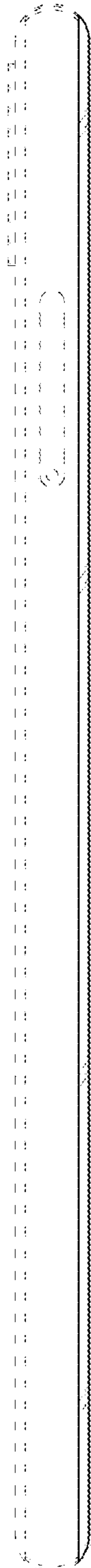

FIG. 19





FIG. 20

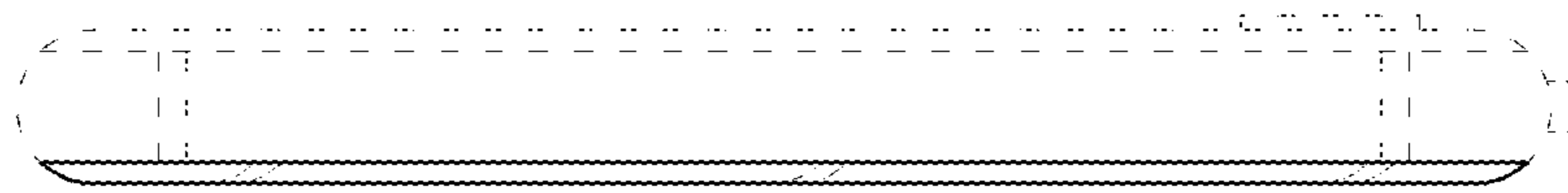

FIG. 21

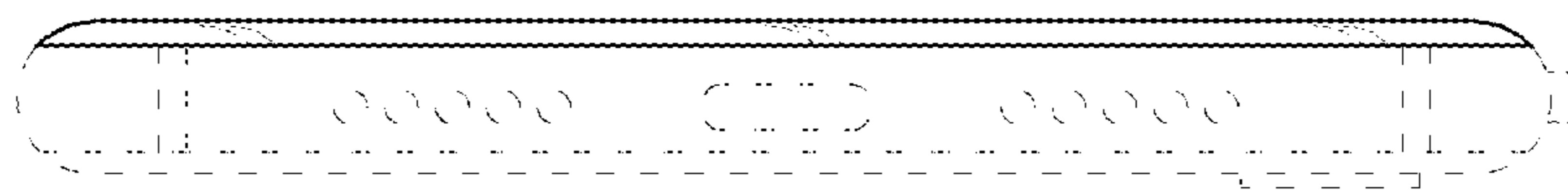

FIG. 22

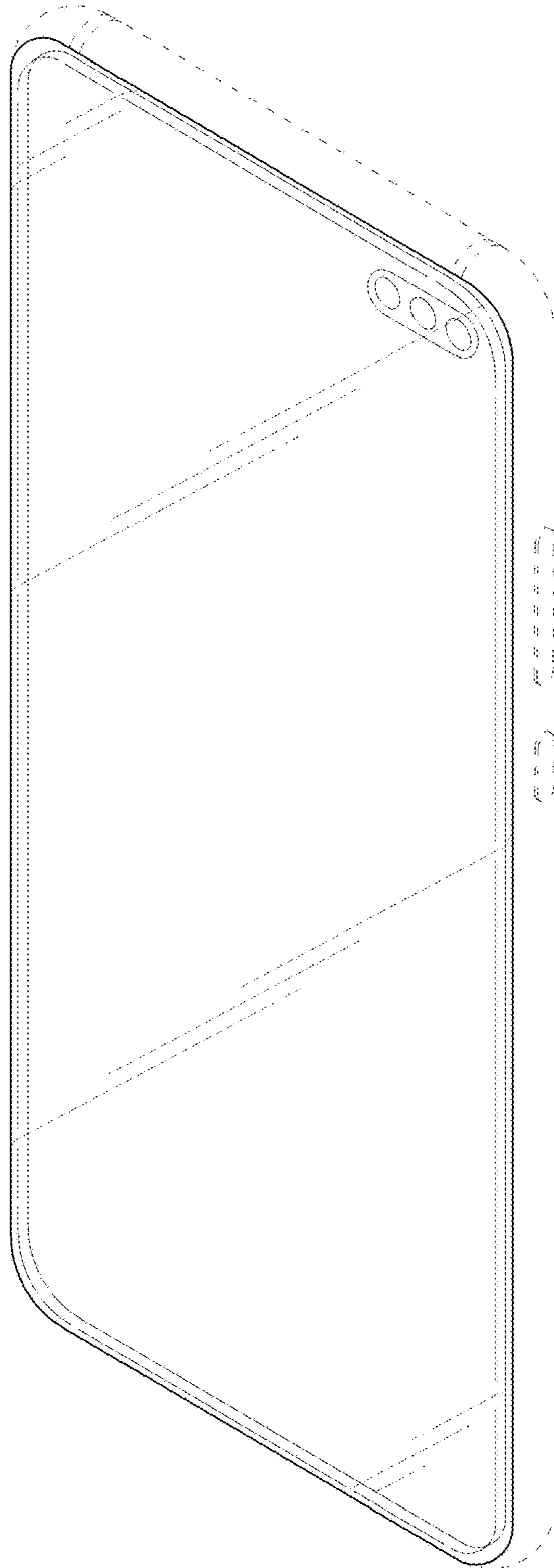

FIG. 23

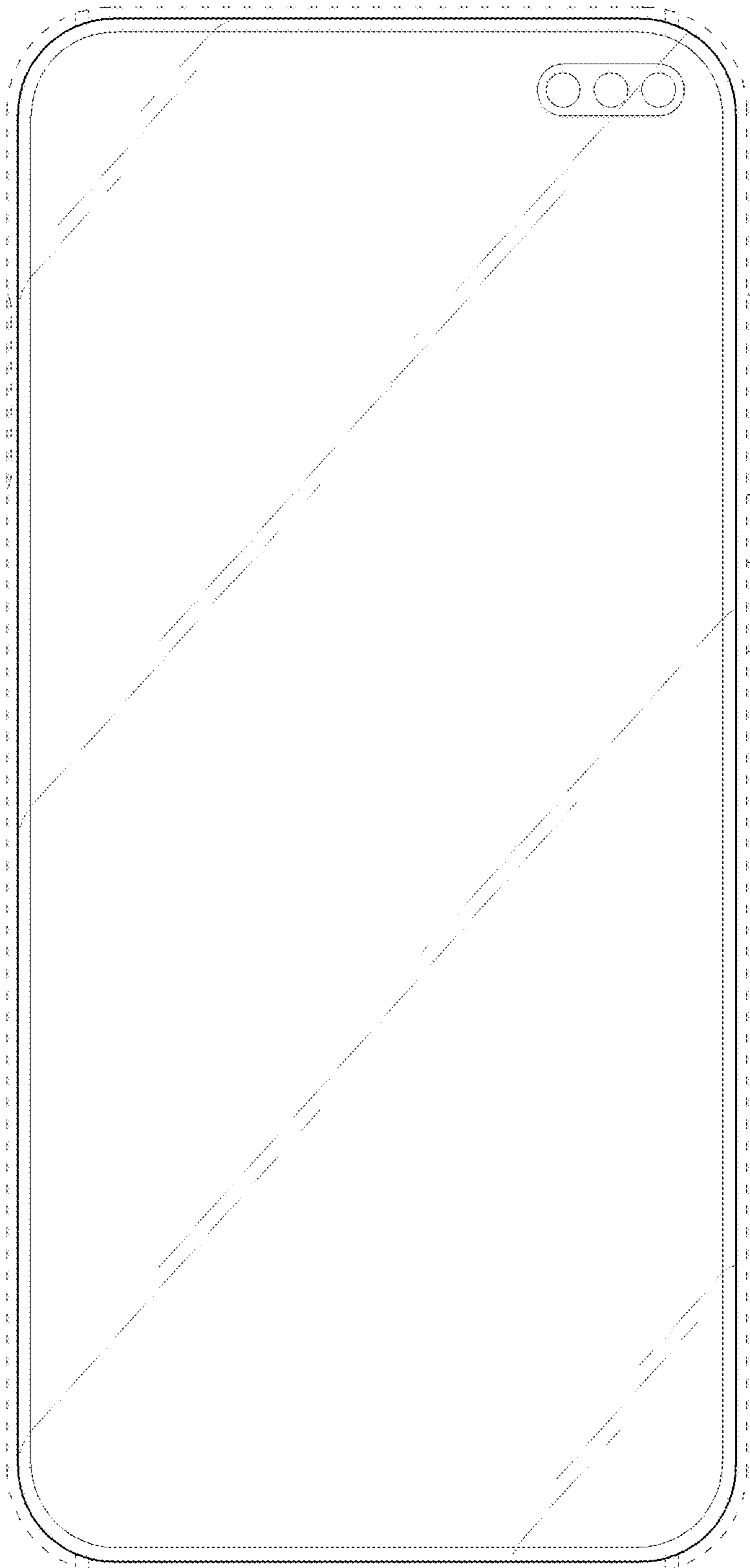

FIG. 24



FIG. 25

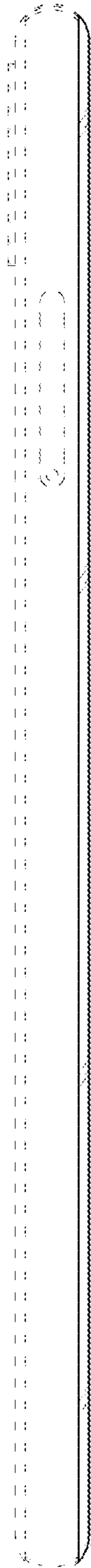

FIG. 26



FIG. 27



FIG. 28

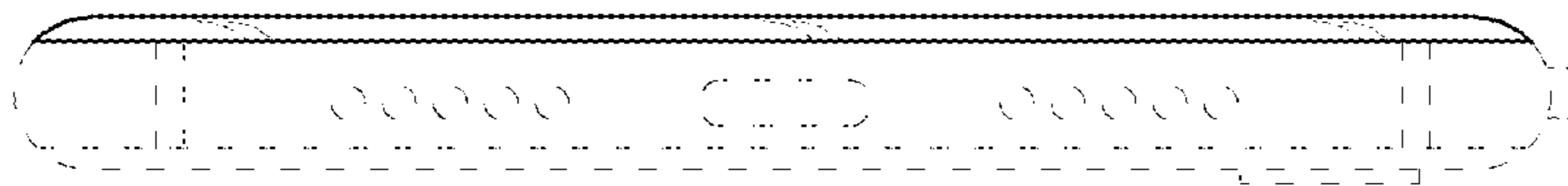

FIG. 29

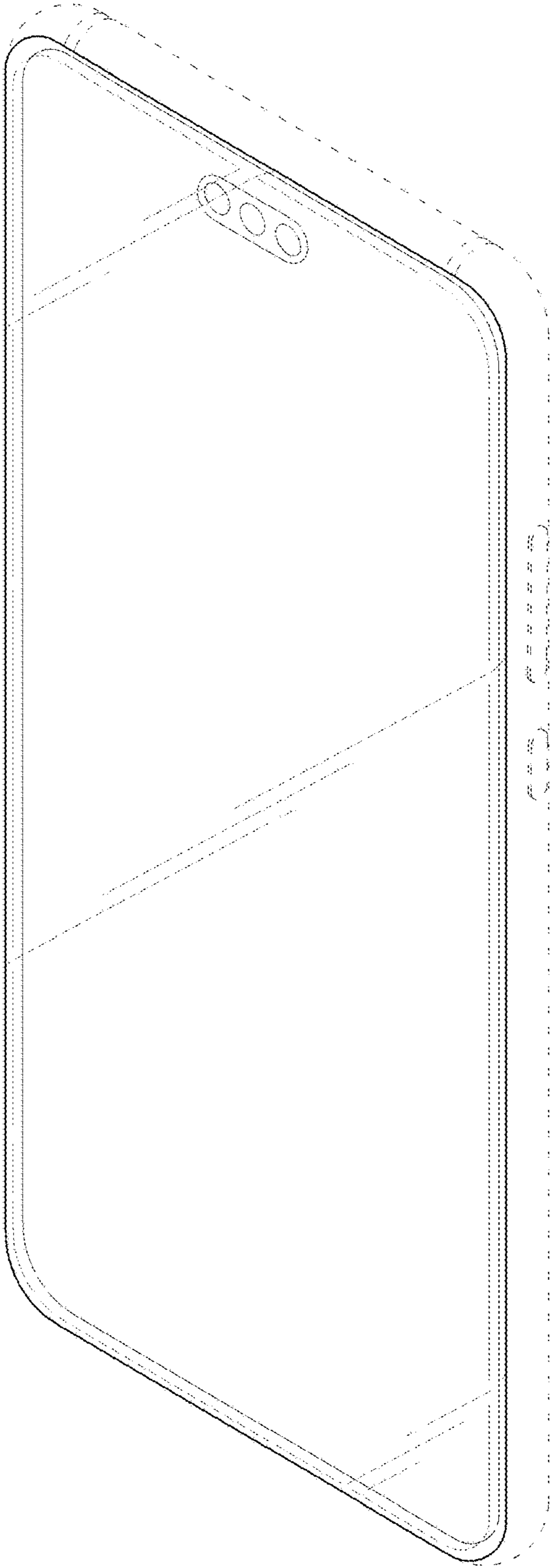

FIG. 30

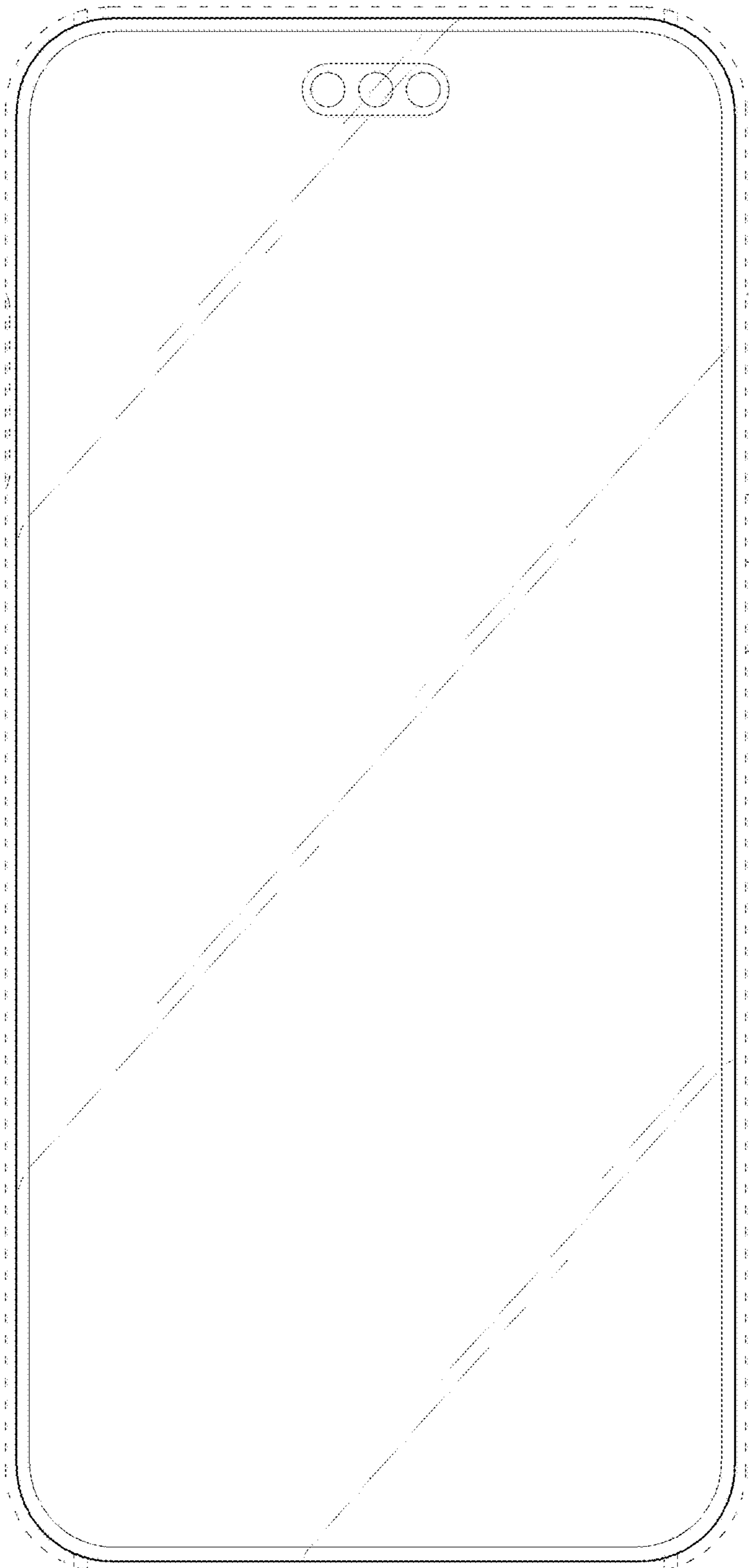



FIG. 31

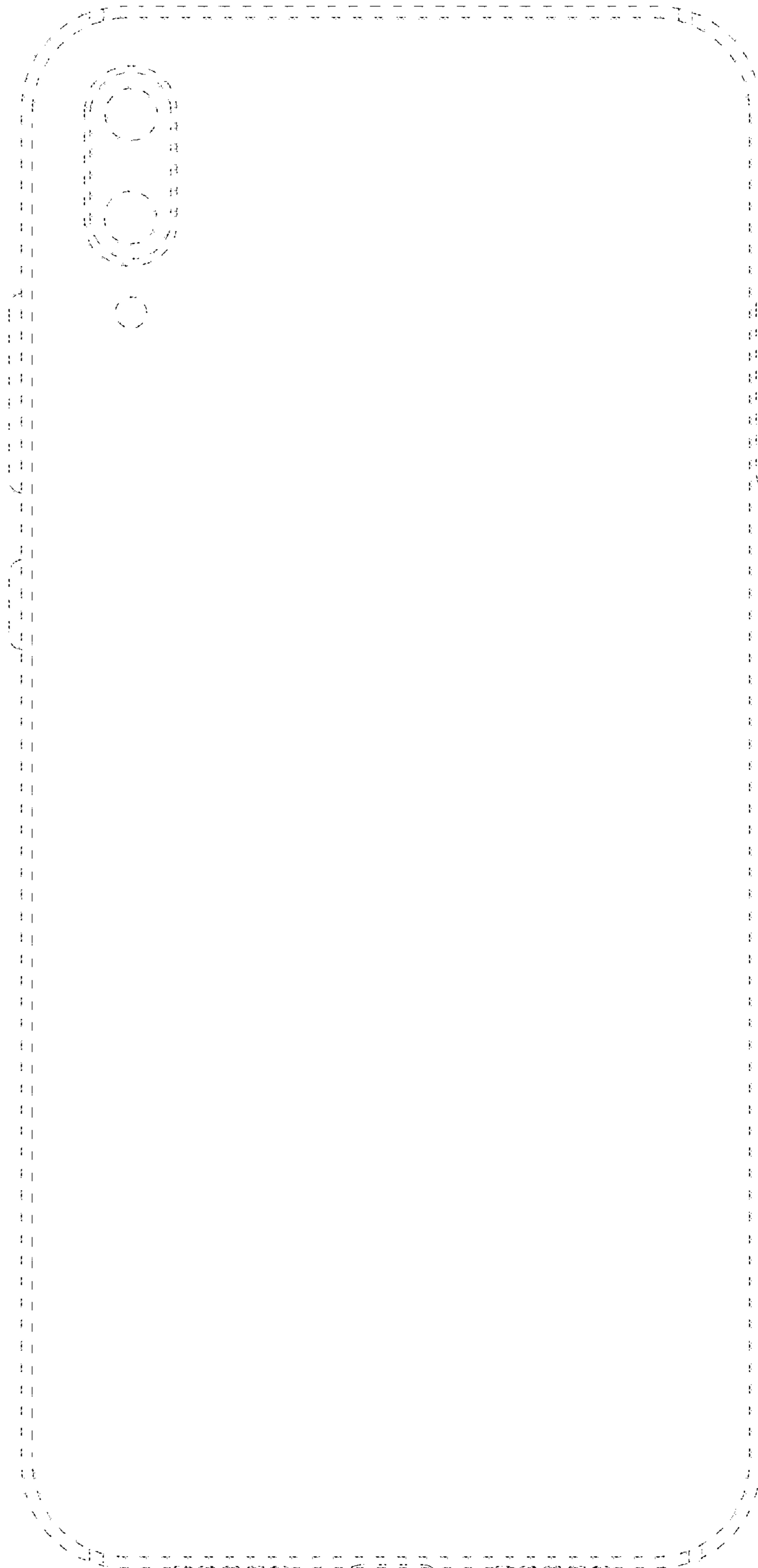

FIG. 32

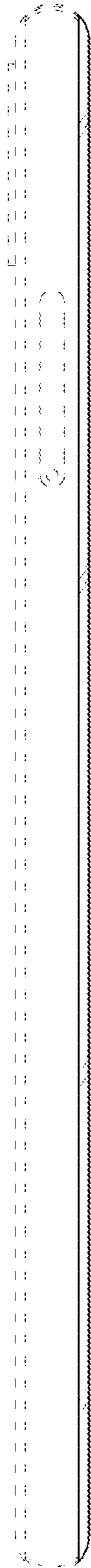

FIG. 33



FIG. 34



FIG. 35

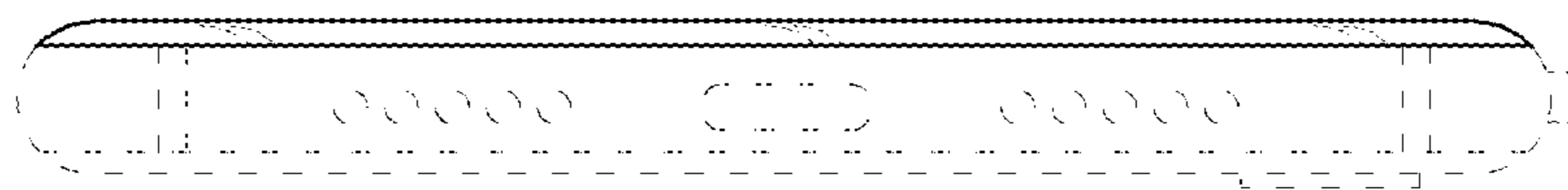

FIG. 36

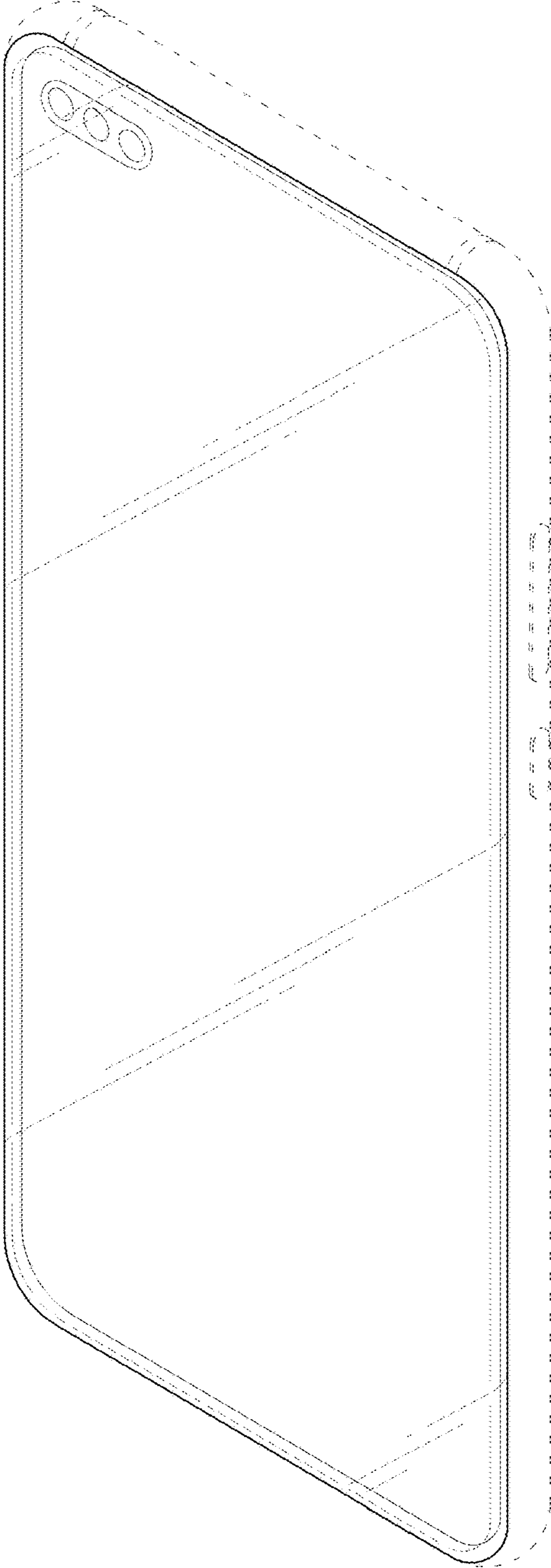

FIG. 37

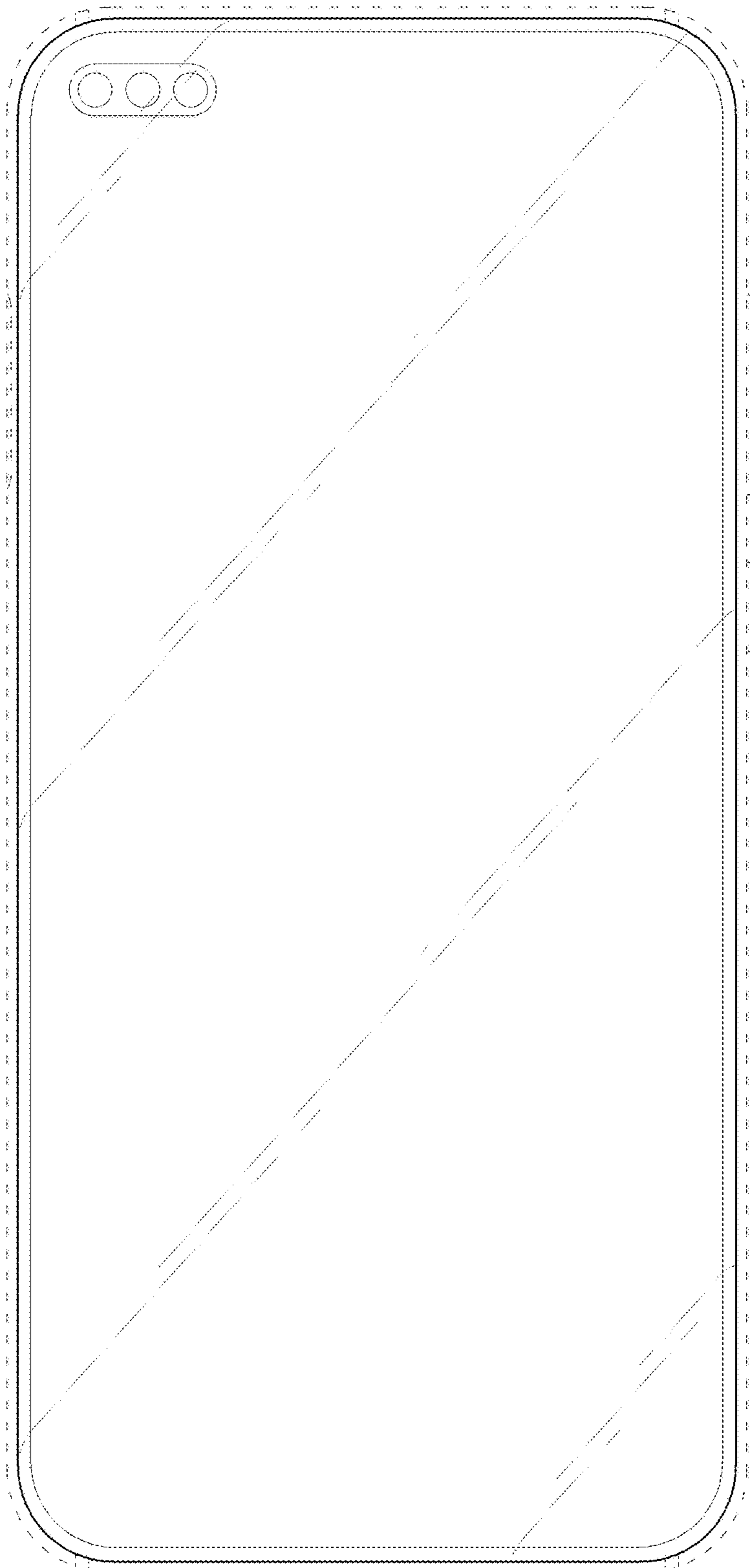

FIG. 38



FIG. 39

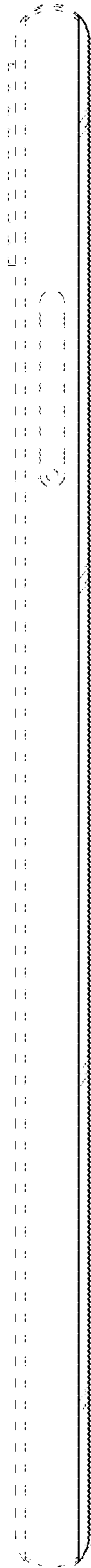

FIG. 40



FIG. 41

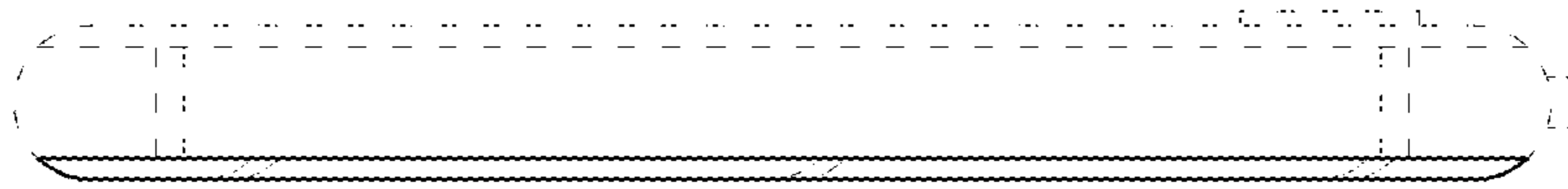

FIG. 42

