



US00D910002S

(12) **United States Design Patent** (10) **Patent No.:** **US D910,002 S**
Seo (45) **Date of Patent:** **** Feb. 9, 2021**

(54) **MOBILE COMMUNICATION TERMINAL**

(74) *Attorney, Agent, or Firm* — McAndrews Held & Malloy, Ltd.

(71) Applicant: **Samsung Electronics Co., Ltd.**, Suwon-si (KR)

(57) **CLAIM**

The ornamental design for a mobile communication terminal, as shown and described.

(72) Inventor: **Jaehun Seo**, Suwon-si (KR)

(73) Assignee: **SAMSUNG ELECTRONICS CO., LTD.**, Suwon-si (KR)

DESCRIPTION

(**) Term: **15 Years**

FIG. 1 is a front perspective view of a mobile communication terminal showing my new design according to a first embodiment;

(21) Appl. No.: **29/693,609**

FIG. 2 is a front elevation view thereof;

(22) Filed: **Jun. 4, 2019**

FIG. 3 is a rear elevation view thereof;

(30) **Foreign Application Priority Data**

Dec. 14, 2018 (KR) 30-2018-0059230

FIG. 4 is a left side elevation view thereof;

(51) **LOC (13) Cl.** **14-03**

FIG. 5 is a right side elevation view thereof;

(52) **U.S. Cl.**

USPC **D14/248**

FIG. 6 is a top plan view thereof;

(58) **Field of Classification Search**

USPC D14/138 G, 138 AD, 138 AB, 248, 341, D14/371, 374, 138 R, 138 AA, 138 AC, D14/138 C, 247

FIG. 7 is a bottom plan view thereof;

FIG. 8 is a rear perspective view thereof;

FIG. 9 is a front perspective view of a mobile communication terminal showing my new design according to a second embodiment;

(Continued)

(56) **References Cited**

U.S. PATENT DOCUMENTS

D613,722 S * 4/2010 Kaneta D14/138 G
D654,049 S * 2/2012 Chung D14/138 G

FIG. 10 is a front elevation view thereof;

FIG. 11 is a rear elevation view thereof;

FIG. 12 is a left side elevation view thereof;

FIG. 13 is a right side elevation view thereof;

FIG. 14 is a top plan view thereof;

FIG. 15 is a bottom plan view thereof;

FIG. 16 is a rear perspective view thereof;

FIG. 17 is a front perspective view of a mobile communication terminal showing my new design according to a third embodiment;

(Continued)

OTHER PUBLICATIONS

Samsung Galaxy M40, announced Jun. 2019, [online], [retrieved on Oct. 5, 2020]. Retrieved from Internet, <URL: <http://www.gsmarena.com>>.*

FIG. 18 is a front elevation view thereof;

FIG. 19 is a rear elevation view thereof;

FIG. 20 is a left side elevation view thereof;

FIG. 21 is a right side elevation view thereof;

FIG. 22 is a top plan view thereof;

FIG. 23 is a bottom plan view thereof;

FIG. 24 is a rear perspective view thereof;

FIG. 25 is a front perspective view of a mobile communication terminal showing my new design according to a fourth embodiment;

(Continued)

FIG. 26 is a front elevation view thereof;

(Continued)

Primary Examiner — Bridget L Eland

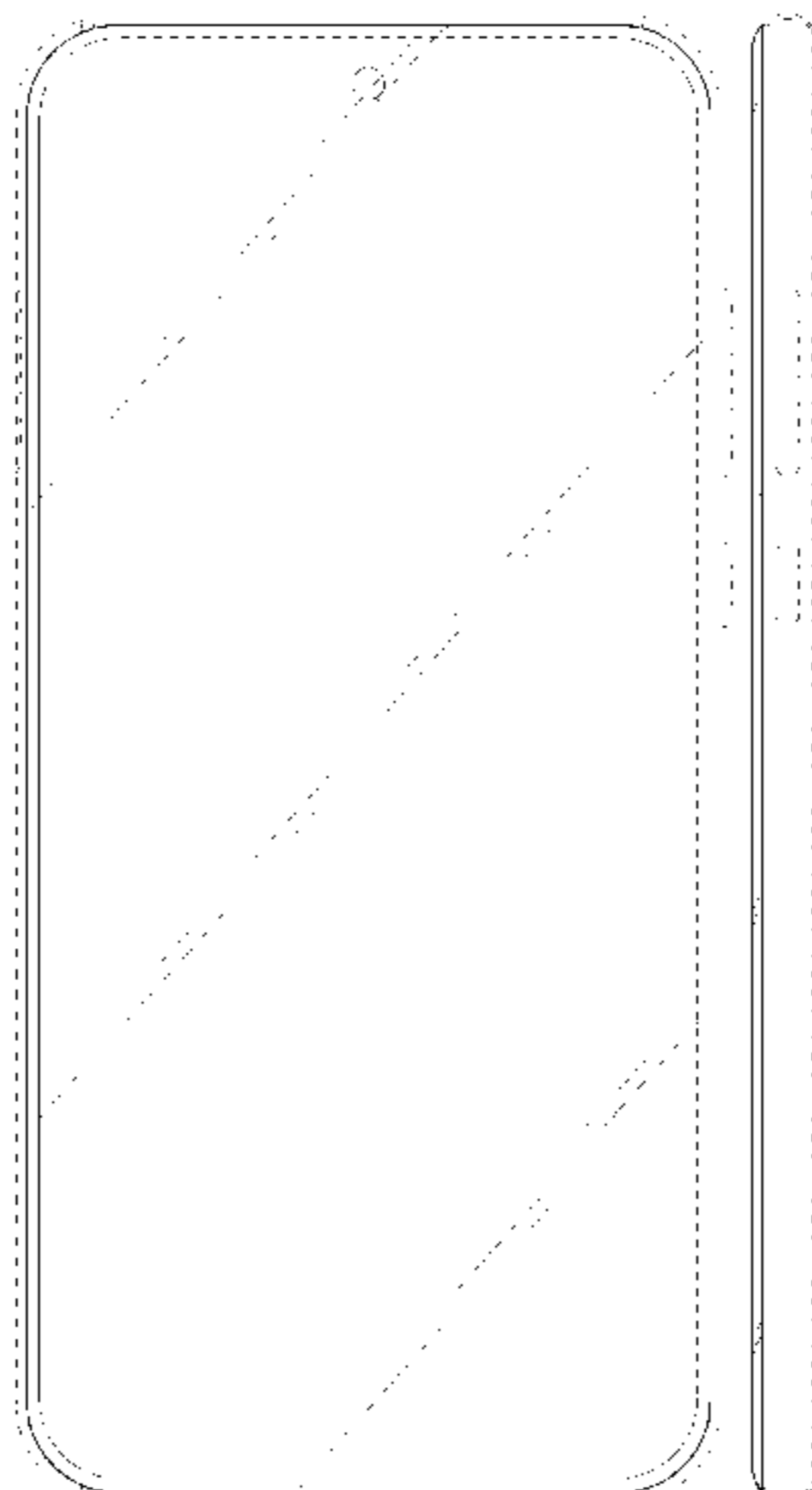

FIG. 27 is a rear elevation view thereof;
 FIG. 28 is a left side elevation view thereof;
 FIG. 29 is a right side elevation view thereof;
 FIG. 30 is a top plan view thereof;
 FIG. 31 is a bottom plan view thereof;
 FIG. 32 is a rear perspective view thereof;
 FIG. 33 is a front perspective view of a mobile communication terminal showing my new design according to a fifth embodiment;
 FIG. 34 is a front elevation view thereof;
 FIG. 35 is a rear elevation view thereof;
 FIG. 36 is a left side elevation view thereof;
 FIG. 37 is a right side elevation view thereof;
 FIG. 38 is a top plan view thereof;
 FIG. 39 is a bottom plan view thereof;
 FIG. 40 is a rear perspective view thereof;
 FIG. 41 is a front perspective view of a mobile communication terminal showing my new design according to a sixth embodiment;
 FIG. 42 is a front elevation view thereof;
 FIG. 43 is a rear elevation view thereof;
 FIG. 44 is a left side elevation view thereof;
 FIG. 45 is a right side elevation view thereof;
 FIG. 46 is a top plan view thereof;
 FIG. 47 is a bottom plan view thereof; and,
 FIG. 48 is a rear perspective view thereof.
 The dashed broken lines in the figures depict portions of the mobile communication terminal that form no part of the claimed design.

1 Claim, 36 Drawing Sheets

(58) **Field of Classification Search**

CPC H04M 1/0202; H04M 1/0235; H04M 1/0237; H04M 1/0239; H04M 1/0266; H04M 1/0268; H04M 1/027; H04M 1/0295; H04M 1/02; H04M 1/0279; H04M 1/0283

See application file for complete search history.

(56) **References Cited**

U.S. PATENT DOCUMENTS

D654,464 S * 2/2012 Han D14/138 G
 D676,819 S * 2/2013 Choi D14/138 G
 D687,404 S * 8/2013 Yoshimura D14/138 G
 D703,632 S * 4/2014 Lim D14/138 G
 D711,341 S * 8/2014 Shin D14/138 G

D744,450 S * 12/2015 Kim D14/138 G
 D746,247 S * 12/2015 Cha D14/138 G
 D753,640 S * 4/2016 Cha D14/248
 D756,951 S * 5/2016 Kim D14/138 G
 D779,452 S * 2/2017 Kim D14/138 G
 D780,143 S * 2/2017 Ahn D14/138 G
 D783,565 S * 4/2017 Kim D14/138 G
 D783,566 S * 4/2017 Kim D14/138 G
 D784,281 S * 4/2017 Ryu D14/138 G
 D791,096 S * 7/2017 Hu D14/138 G
 D798,835 S * 10/2017 Kim D14/138 G
 D800,710 S * 10/2017 Ryu D14/248
 D813,214 S * 3/2018 Fan D14/248
 D820,255 S * 6/2018 Akana D14/341
 D829,186 S * 9/2018 Kim D14/138 G
 D829,677 S * 10/2018 Kim D14/138 G
 D830,987 S * 10/2018 Choe D14/138 G
 D834,553 S * 11/2018 Depape D14/138 G
 D837,176 S * 1/2019 Choi D14/138 G
 D842,831 S * 3/2019 Kim D14/138 G
 D846,539 S * 4/2019 Choe D14/248
 D848,390 S * 5/2019 Cha D14/138 G
 D849,707 S * 5/2019 Choi D14/138 G
 D849,708 S * 5/2019 Park D14/138 G
 D852,157 S * 6/2019 Lin D14/248
 D854,507 S * 7/2019 Depape D14/138 G
 D855,030 S * 7/2019 Depape D14/138 G
 D857,643 S * 8/2019 Choi D14/138 G
 D859,381 S * 9/2019 Lin D14/248
 D859,382 S * 9/2019 Yi D14/248
 D866,496 S * 11/2019 Kim D14/138 G
 D868,763 S * 12/2019 Kim D14/248
 D869,419 S * 12/2019 Cho D14/138 G
 D880,463 S * 4/2020 Kim D14/248
 D890,712 S * 7/2020 Liu D14/138 G
 D891,386 S * 7/2020 Liu D14/138 G
 D892,073 S * 8/2020 Fang D14/138 AB
 D892,780 S * 8/2020 Park D14/248
 D894,858 S * 9/2020 Park D14/138 G
 D894,859 S * 9/2020 Park D14/138 G
 D896,198 S * 9/2020 Nalbandian D14/138 G
 D897,980 S * 10/2020 Wu D14/138 G
 D897,981 S * 10/2020 Kim D14/138 G
 2011/0186345 A1 * 8/2011 Pakula G06F 1/1637
 174/520
 2018/0180866 A1 * 6/2018 Kaminaga H04M 1/04

OTHER PUBLICATIONS

Samsung Galaxy A11, announced Mar. 13, 2020, [online], [retrieved on Oct. 5, 2020]. Retrieved from Internet ,<URL: <http://www.gsmarena.com>>.*
 Samsung Galaxy M11 announced Mar. 30, 2020, [online], [retrieved on Oct. 5, 2020]. Retrieved from Internet ,<URL: <http://www.gsmarena.com>>.*

* cited by examiner

FIG. 1

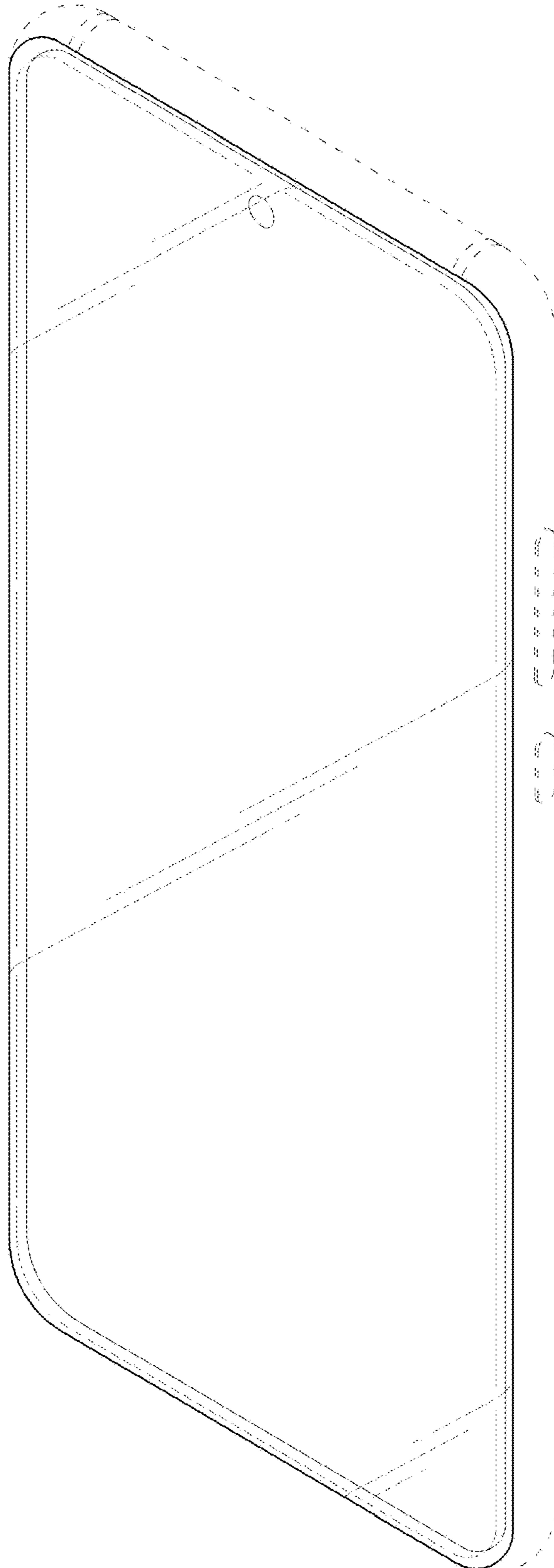

FIG. 2

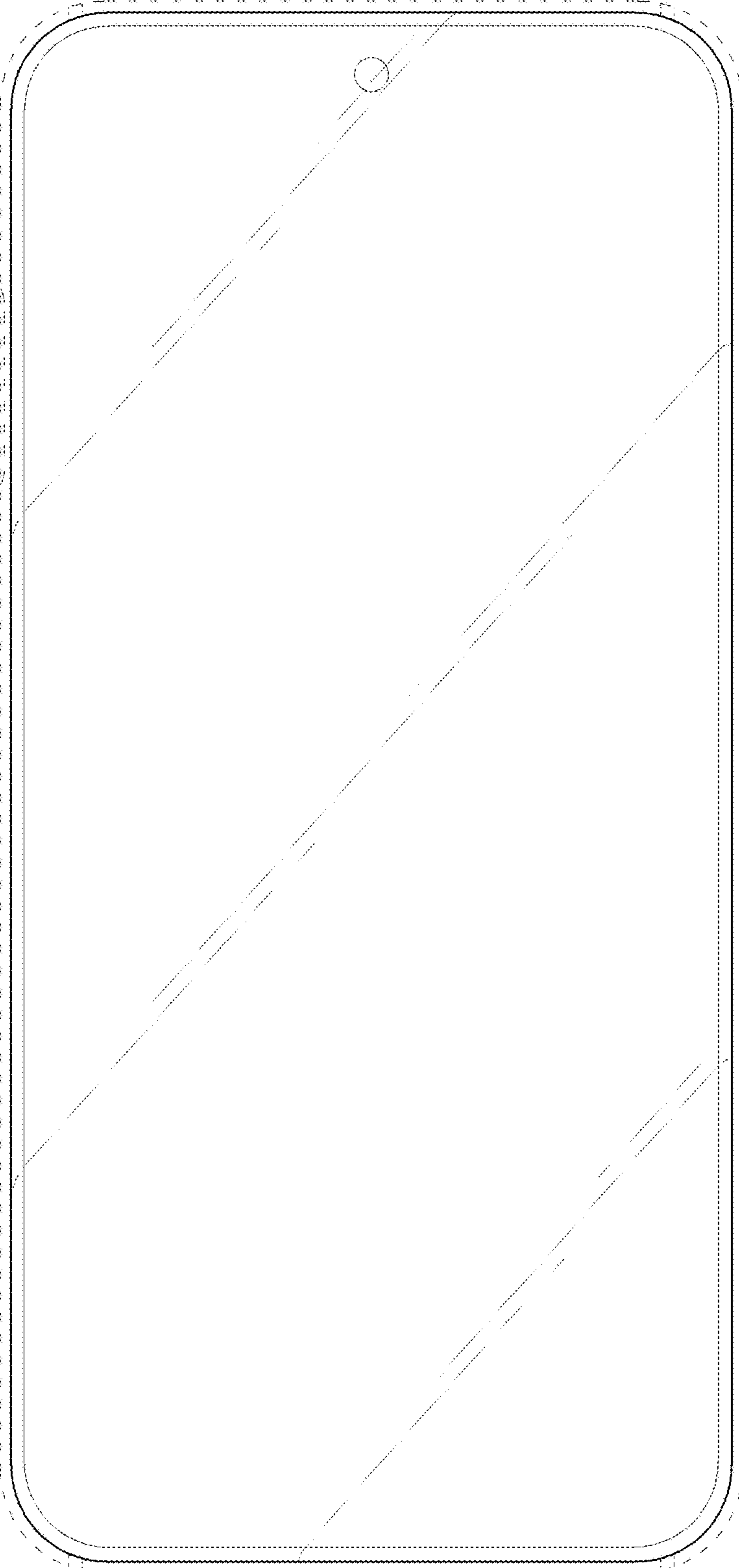

FIG. 3



FIG. 4

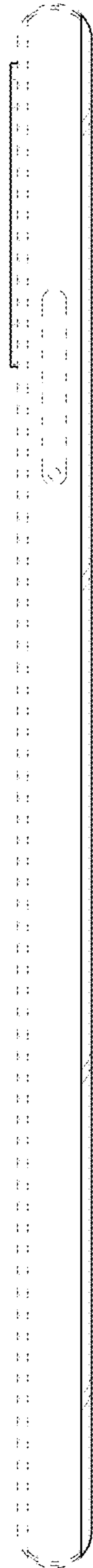

FIG. 5

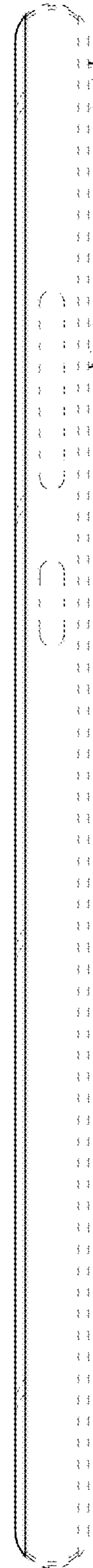

FIG. 6

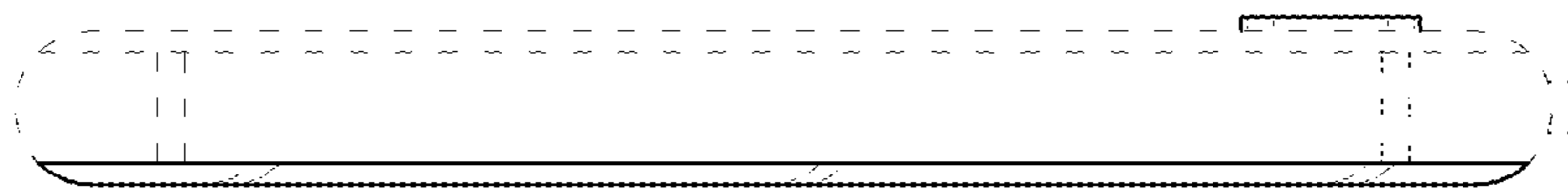

FIG. 7

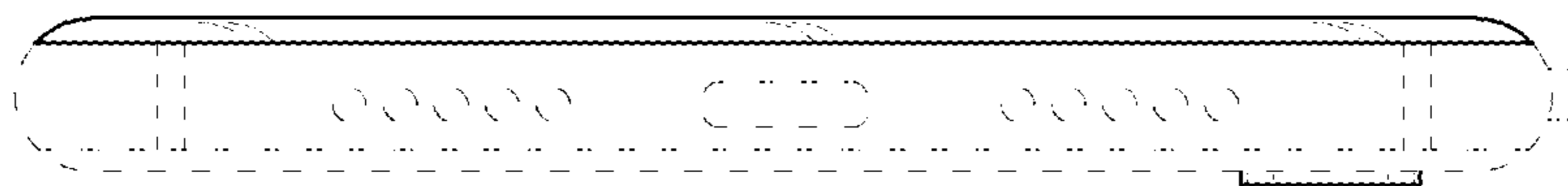

FIG. 8

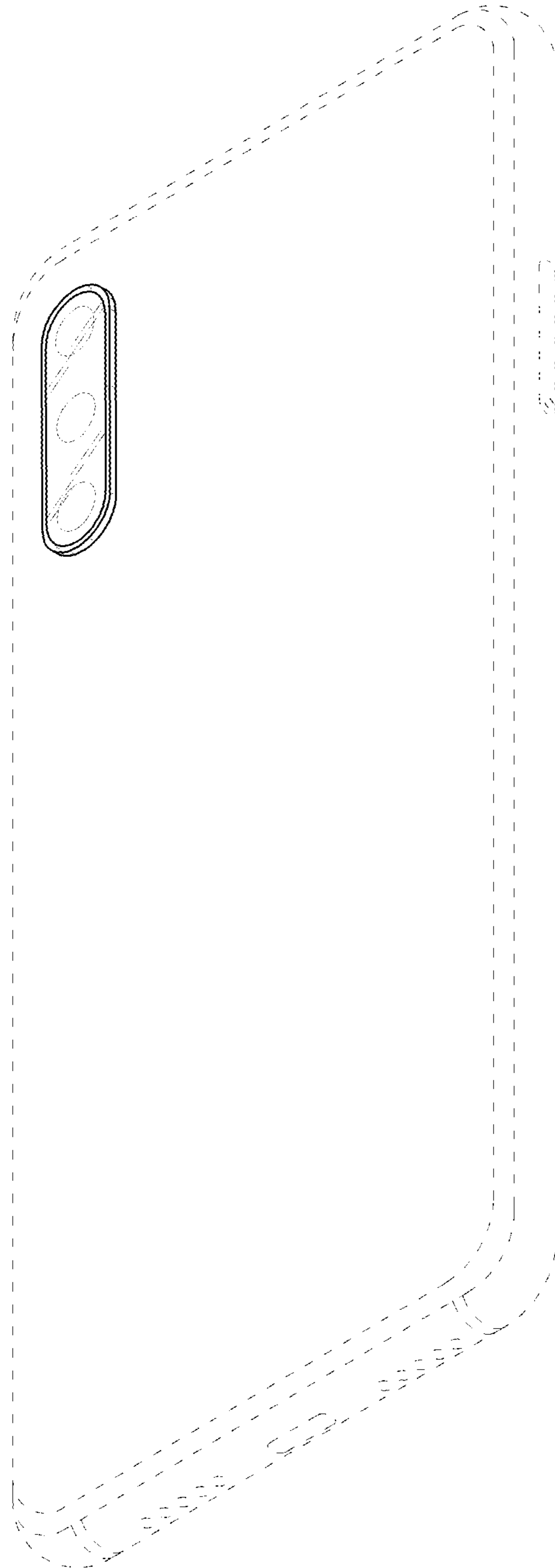

FIG. 9

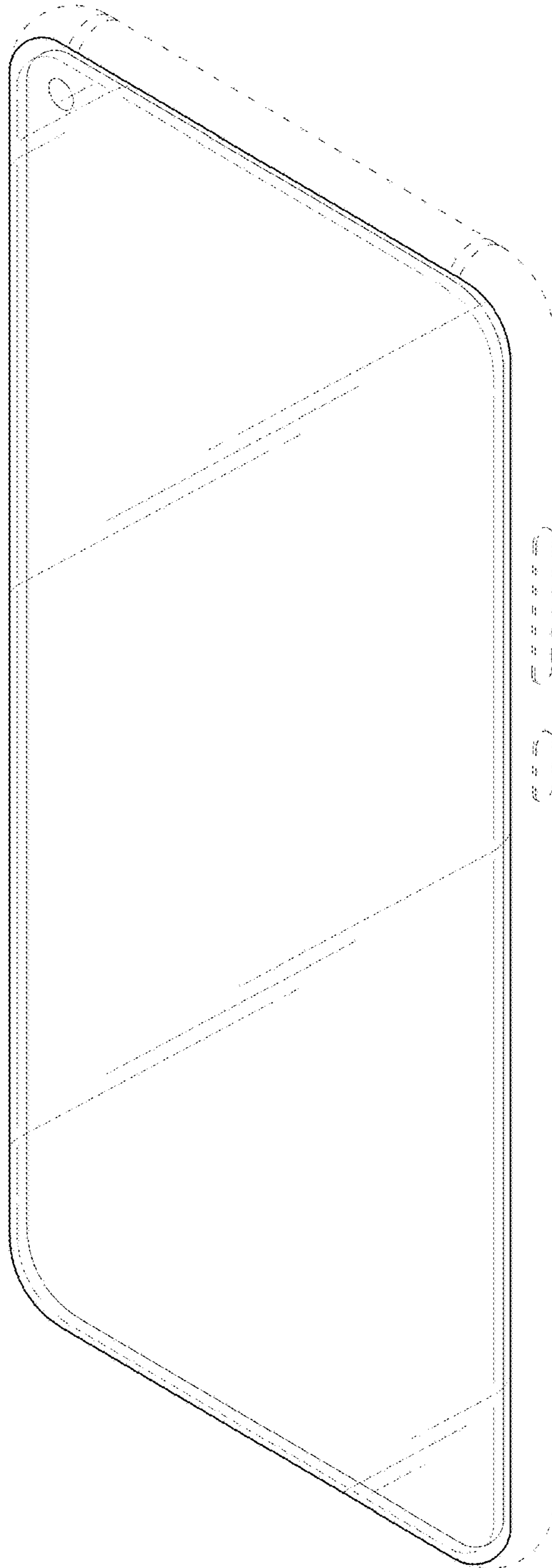

FIG. 10

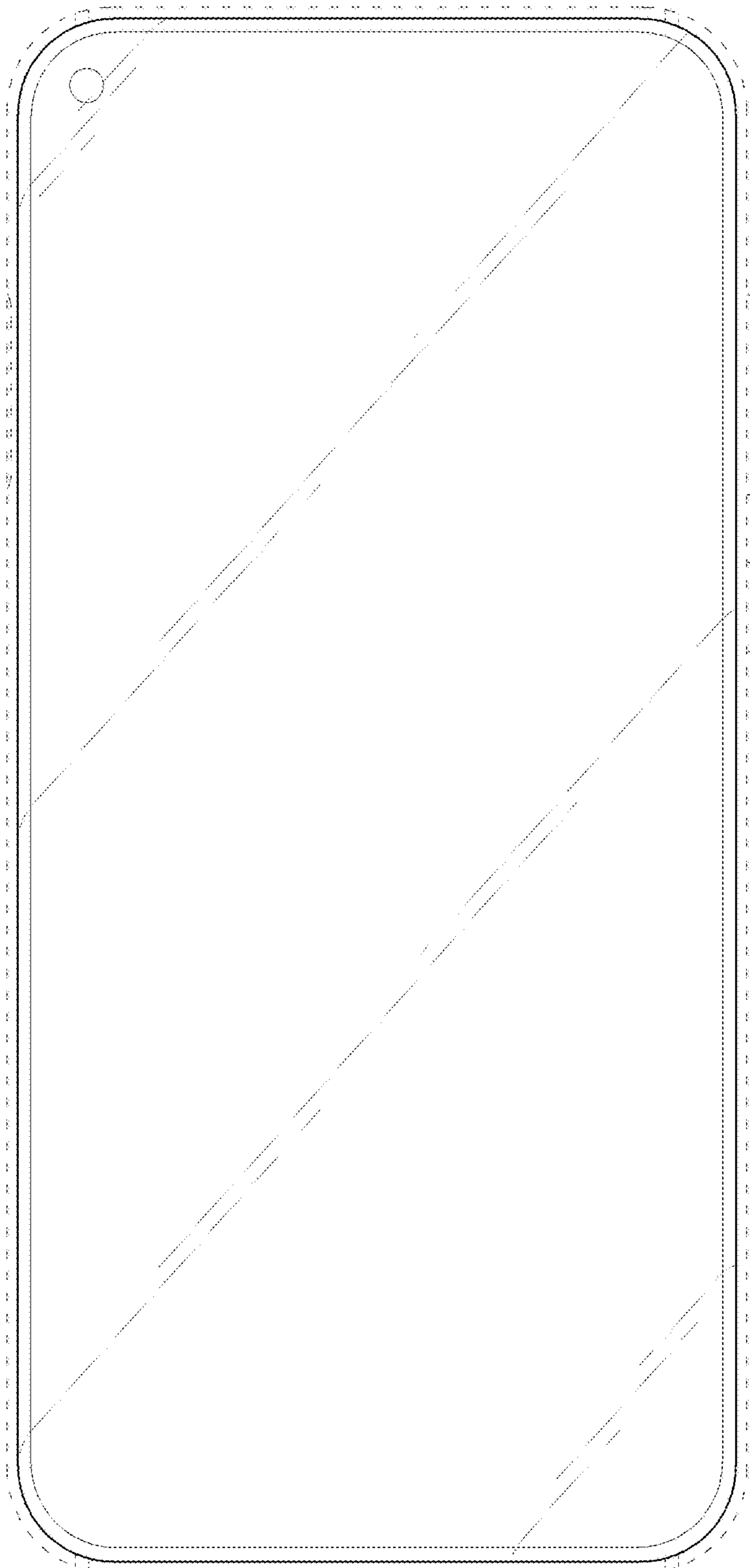

FIG. 11



FIG. 12

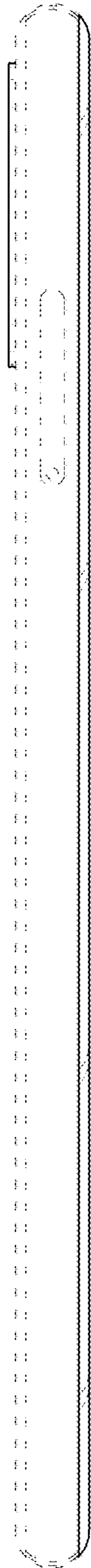

FIG. 13

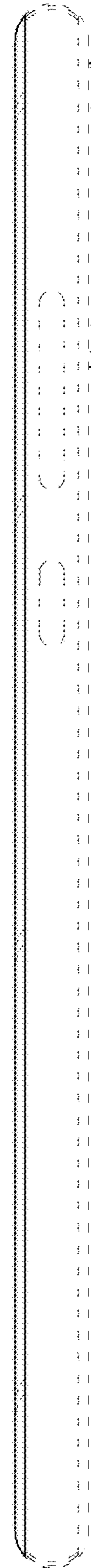

FIG. 14

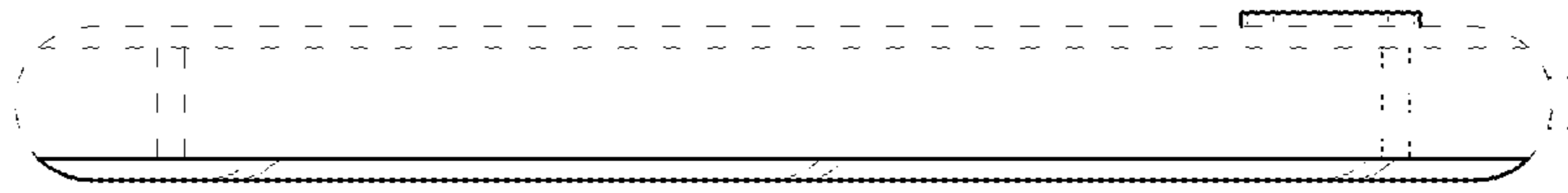

FIG. 15

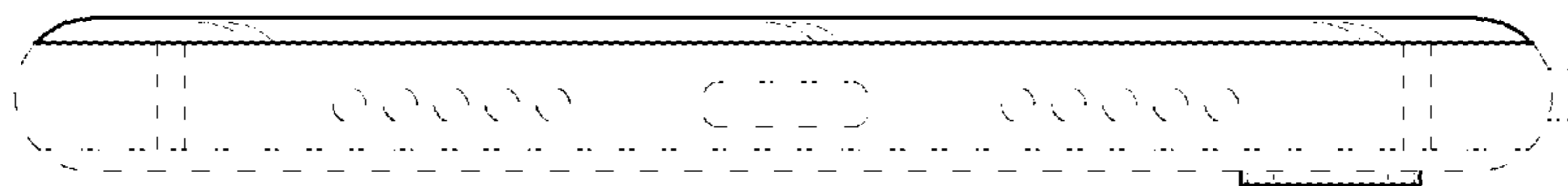

FIG. 16

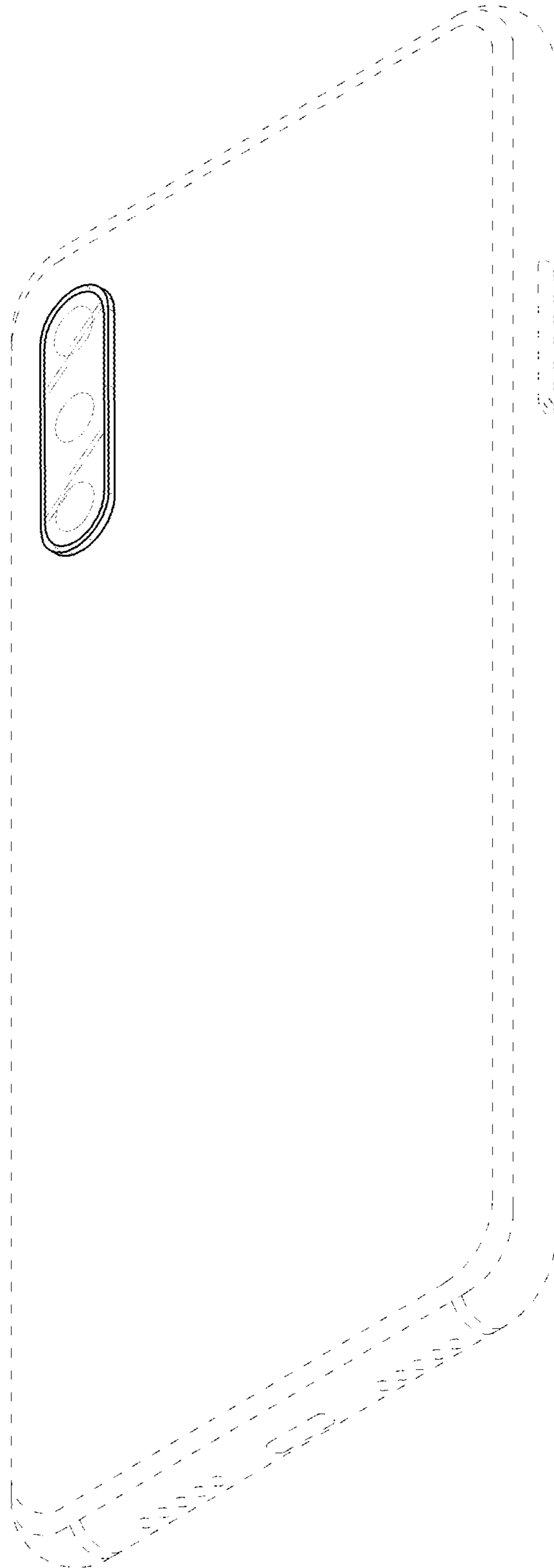

FIG. 17

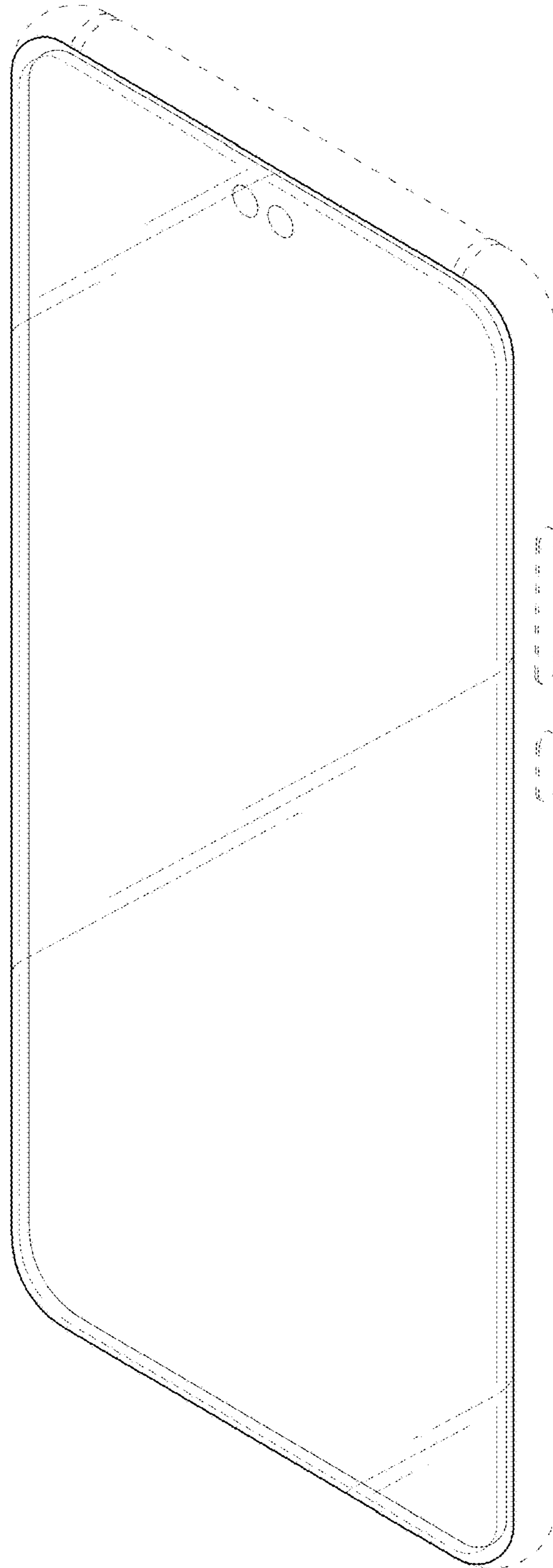

FIG. 18

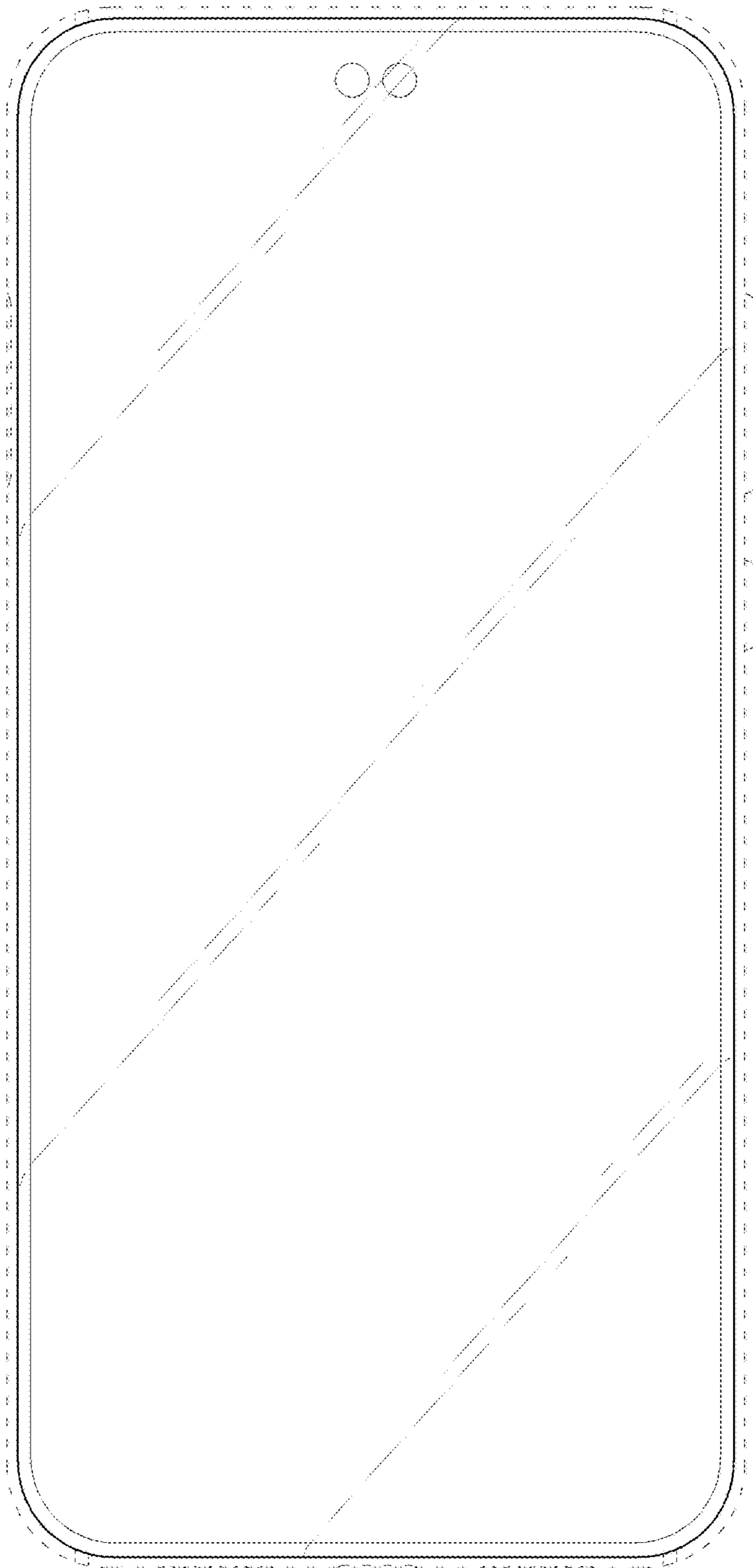

FIG. 19



FIG. 20

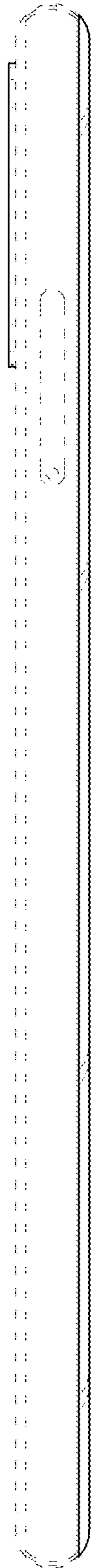

FIG. 21

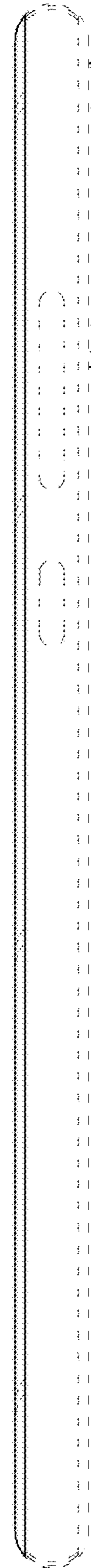

FIG. 22

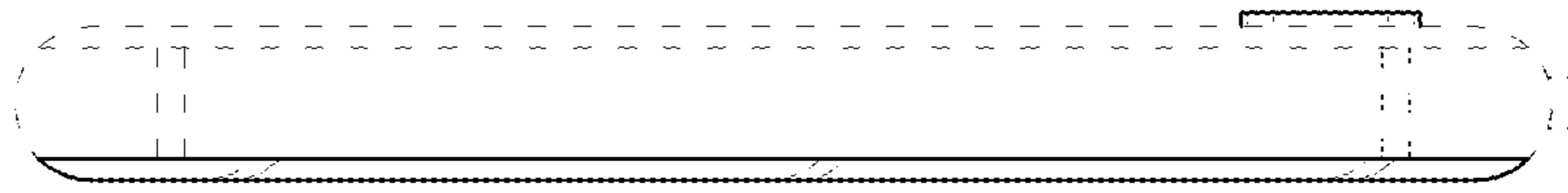

FIG. 23

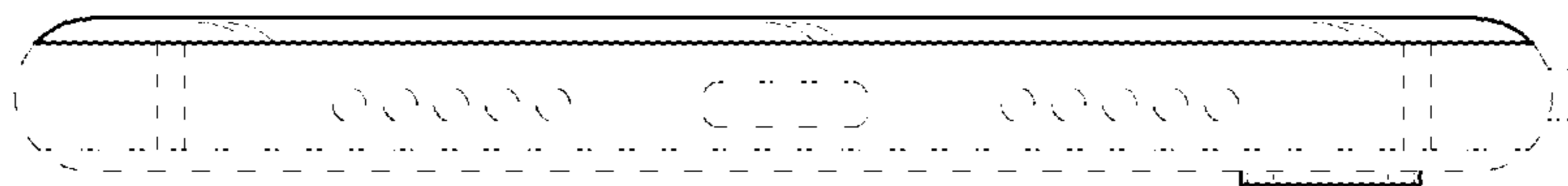

FIG. 24

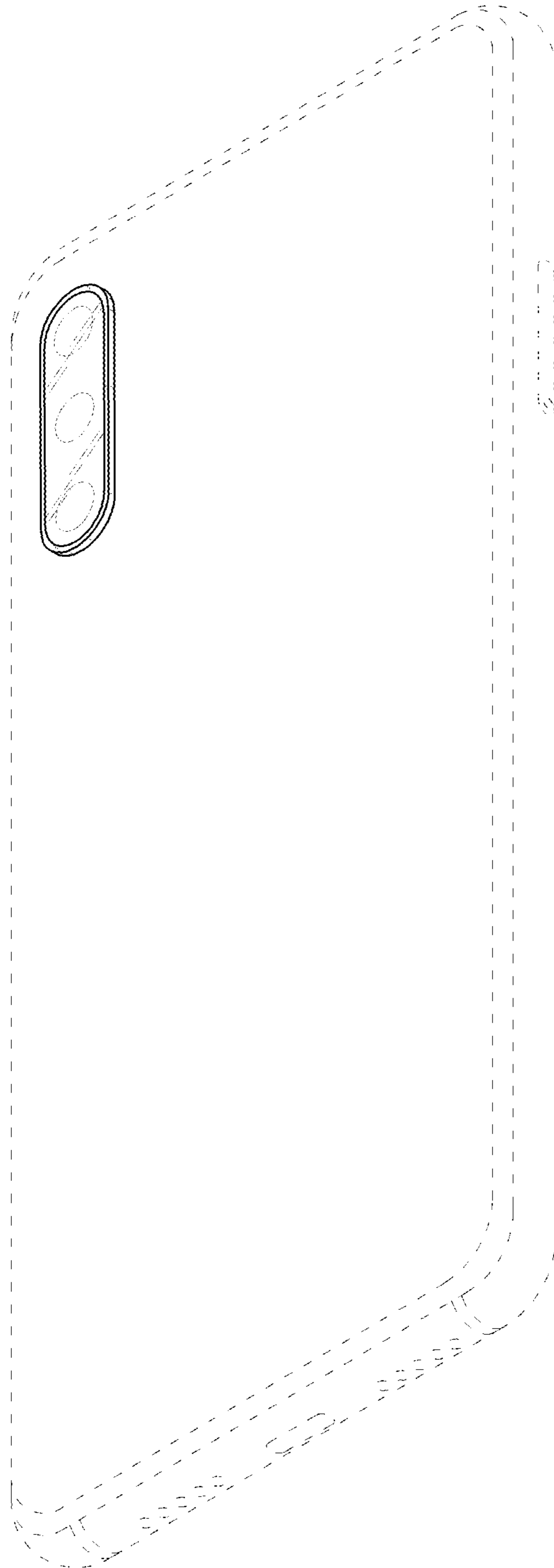

FIG. 25

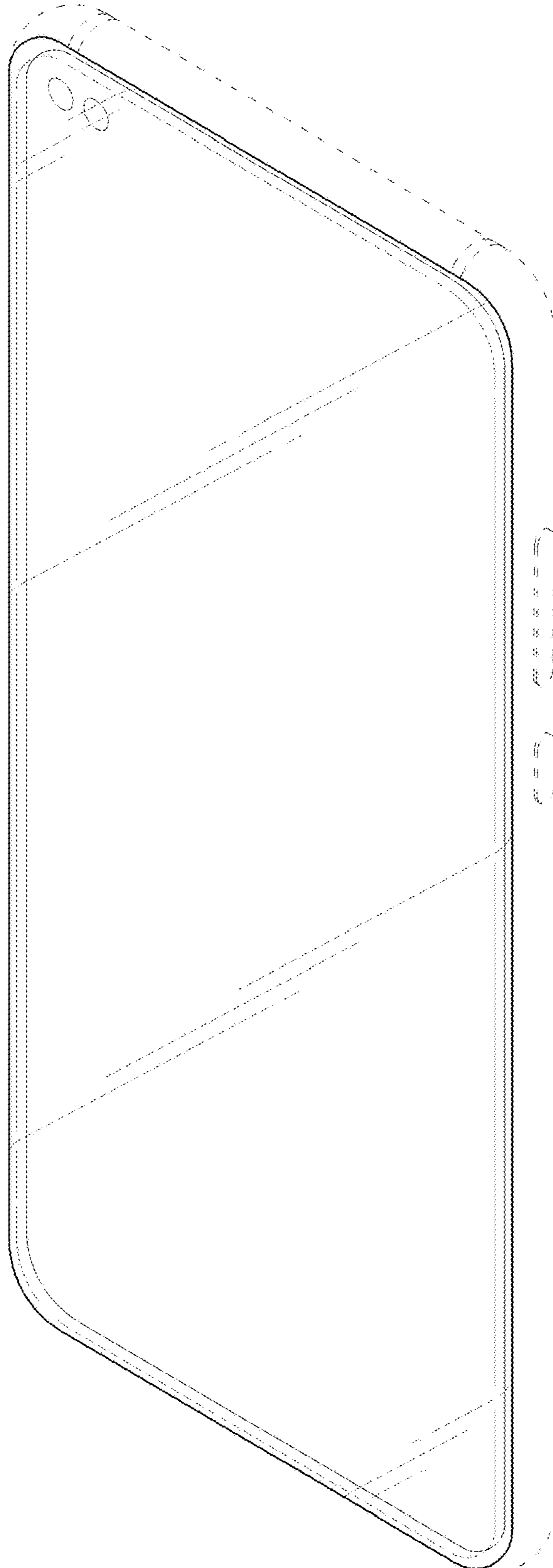

FIG. 26

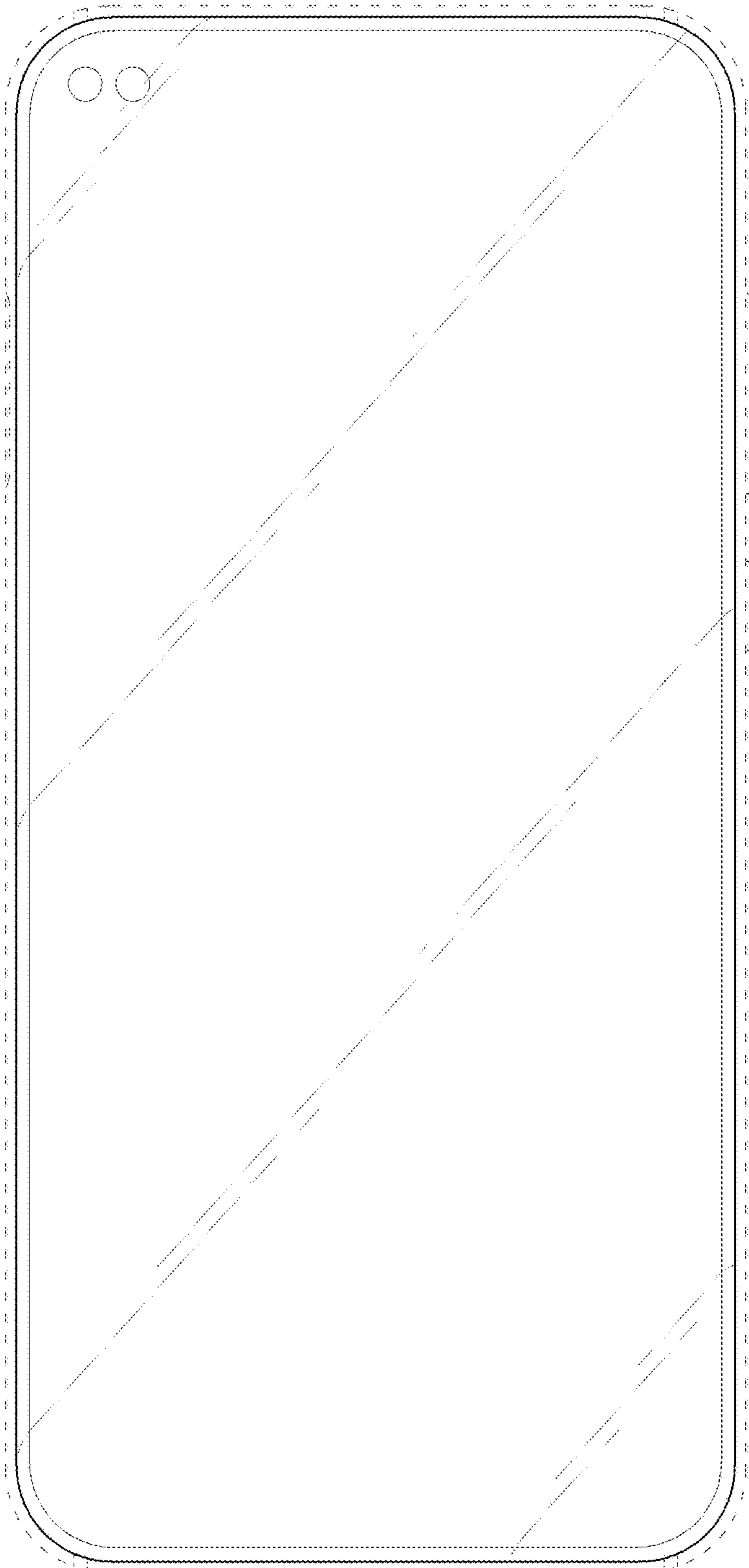

FIG. 27



FIG. 28

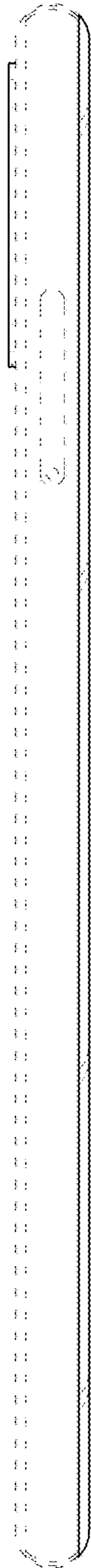

FIG. 29

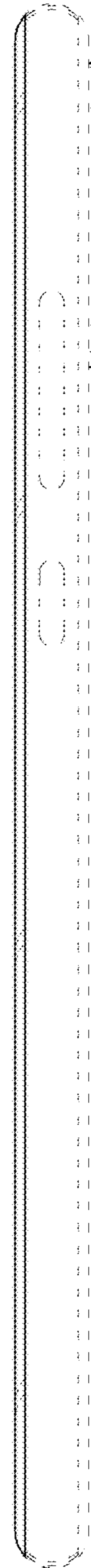

FIG. 30

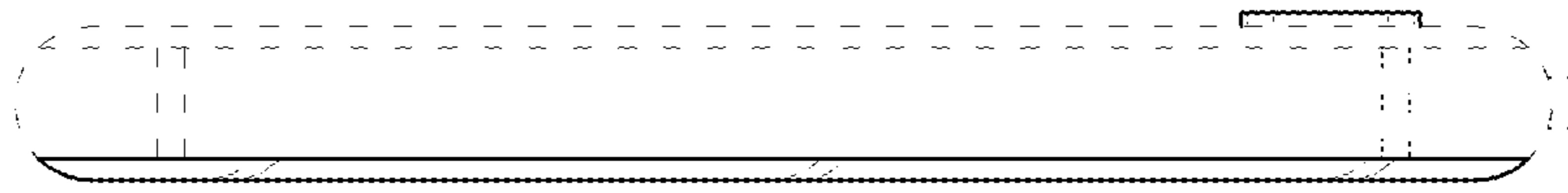

FIG. 31

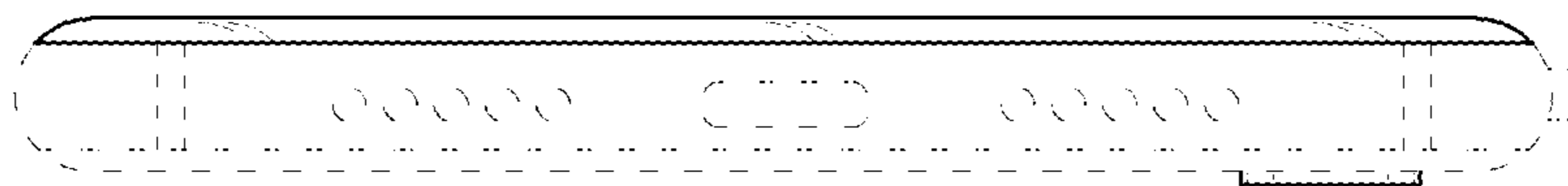

FIG. 32

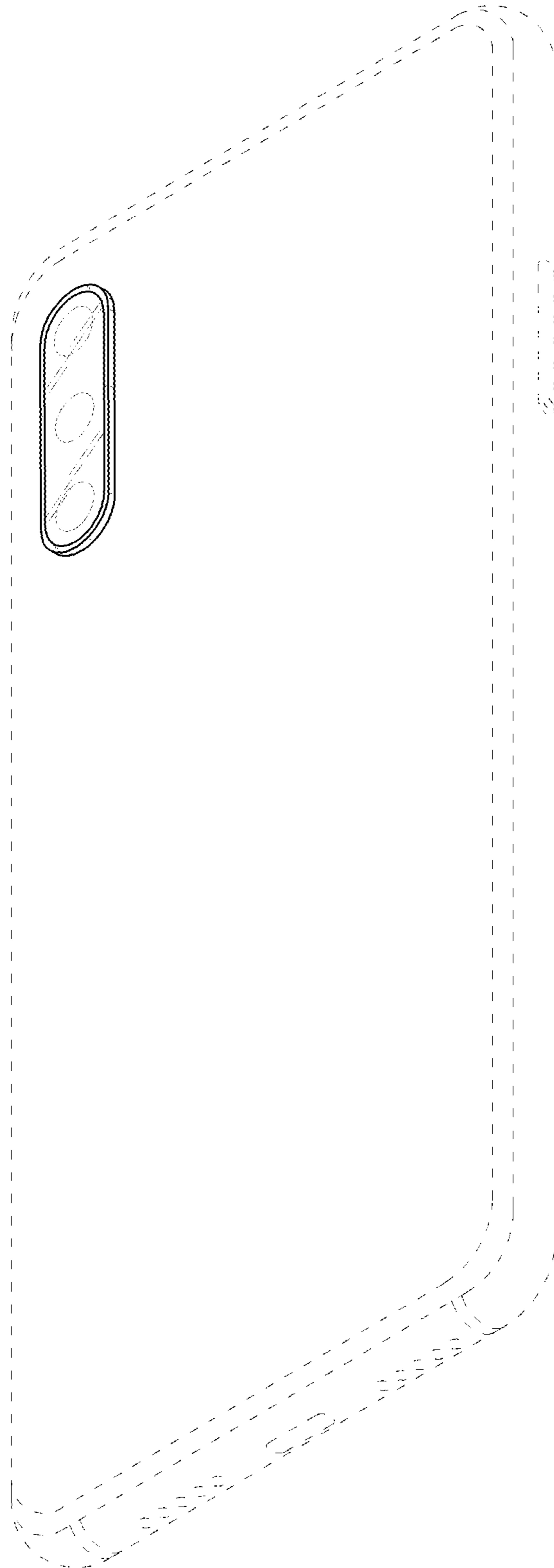

FIG. 33

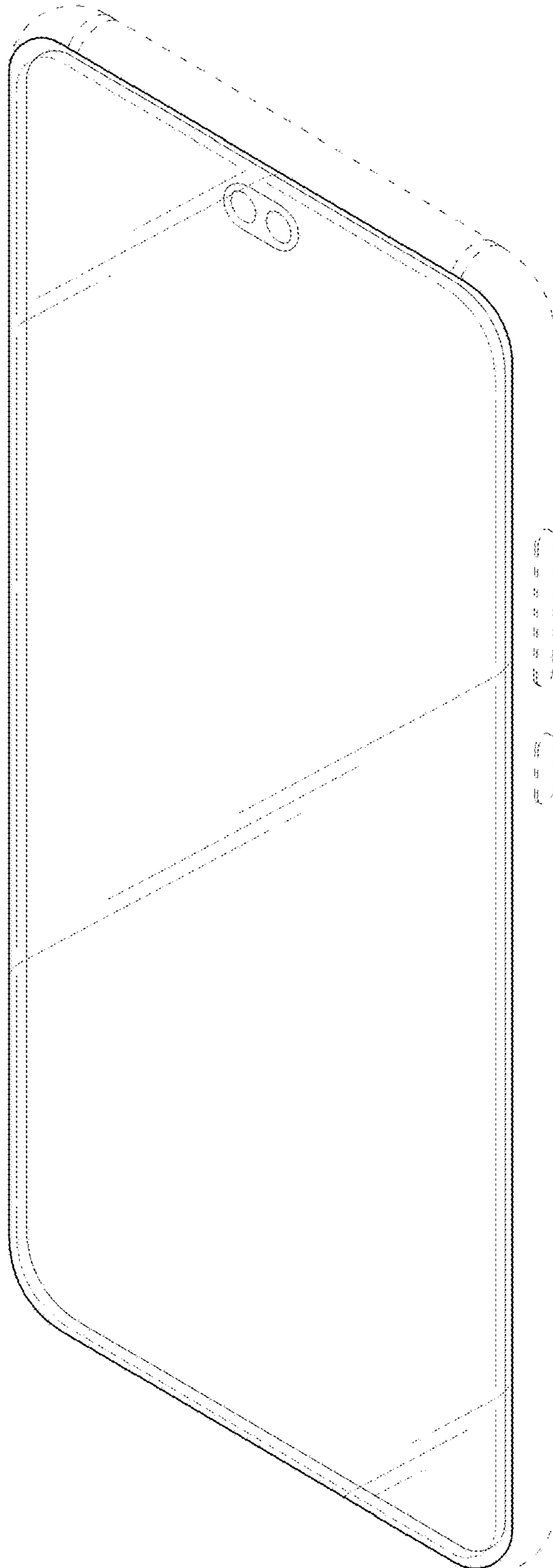

FIG. 34

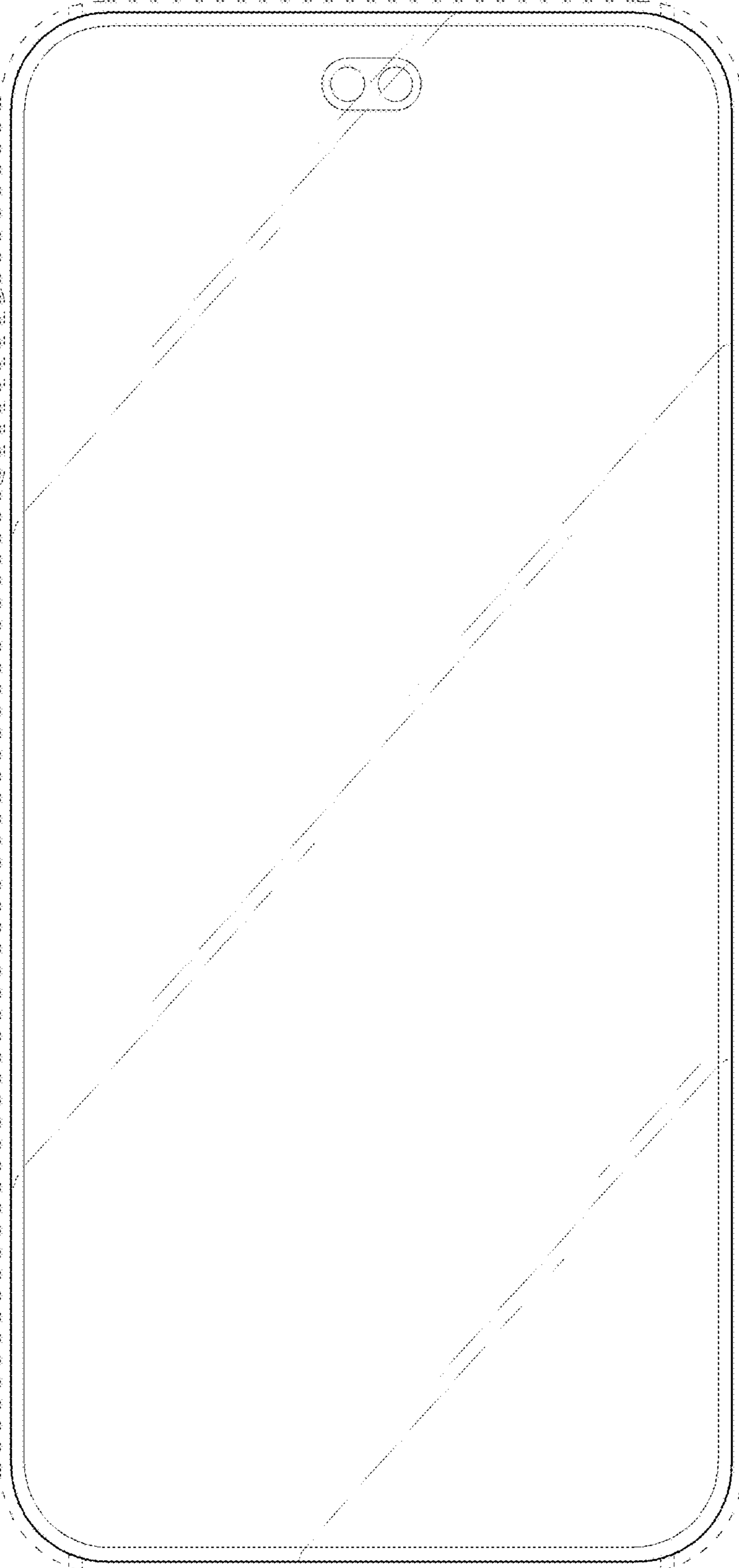

FIG. 35



FIG. 36

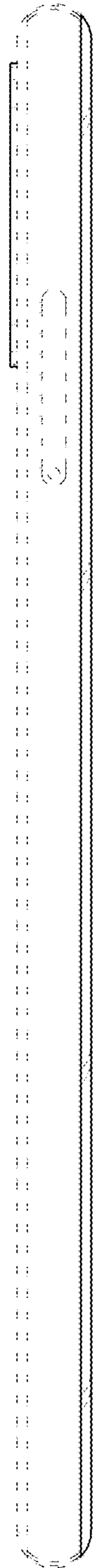

FIG. 37



FIG. 38

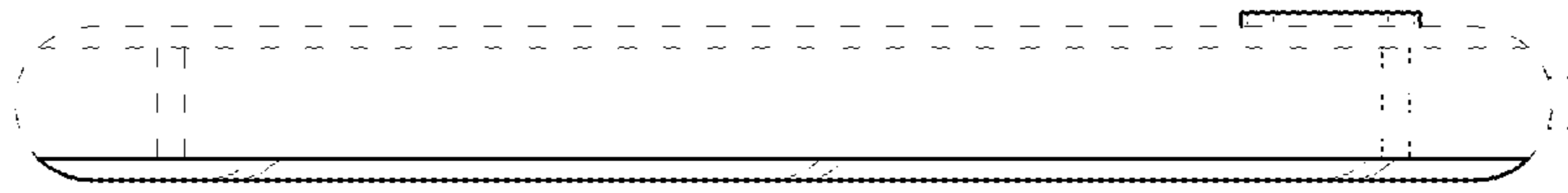

FIG. 39

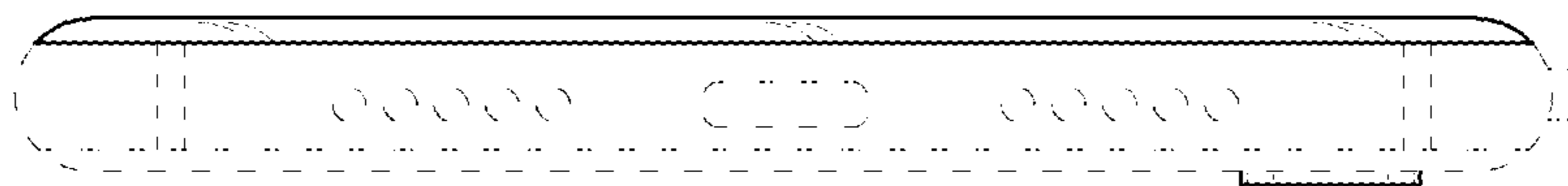

FIG. 40

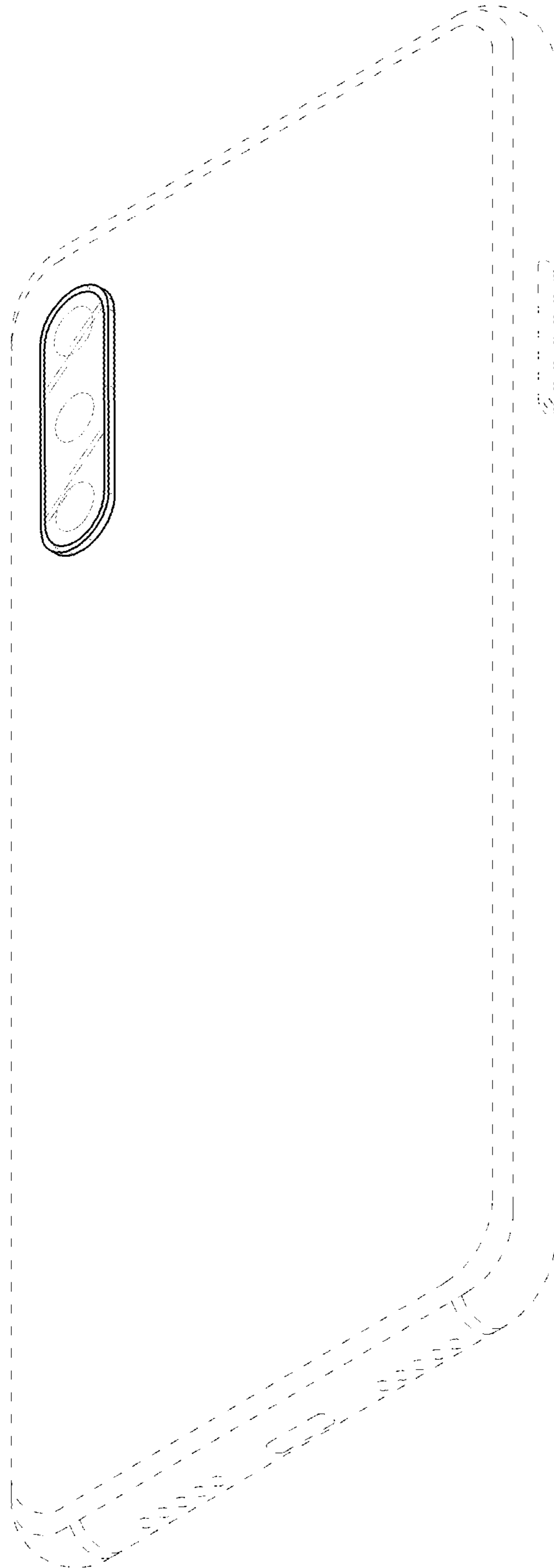

FIG. 41

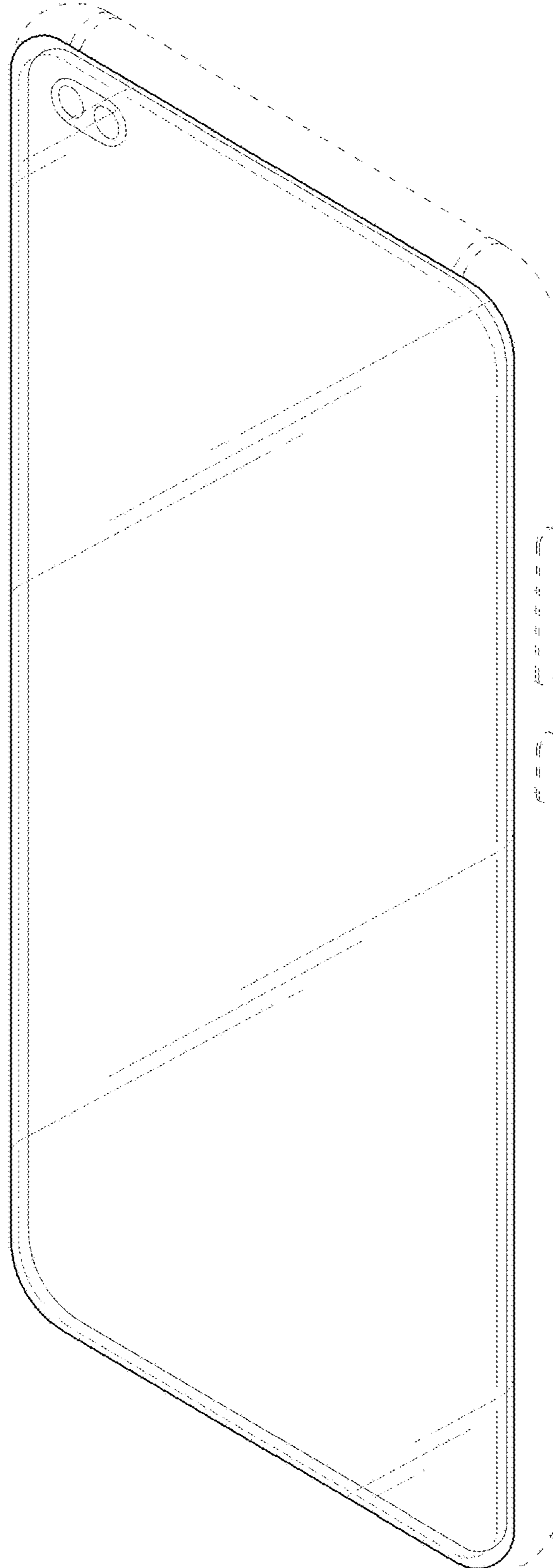

FIG. 42

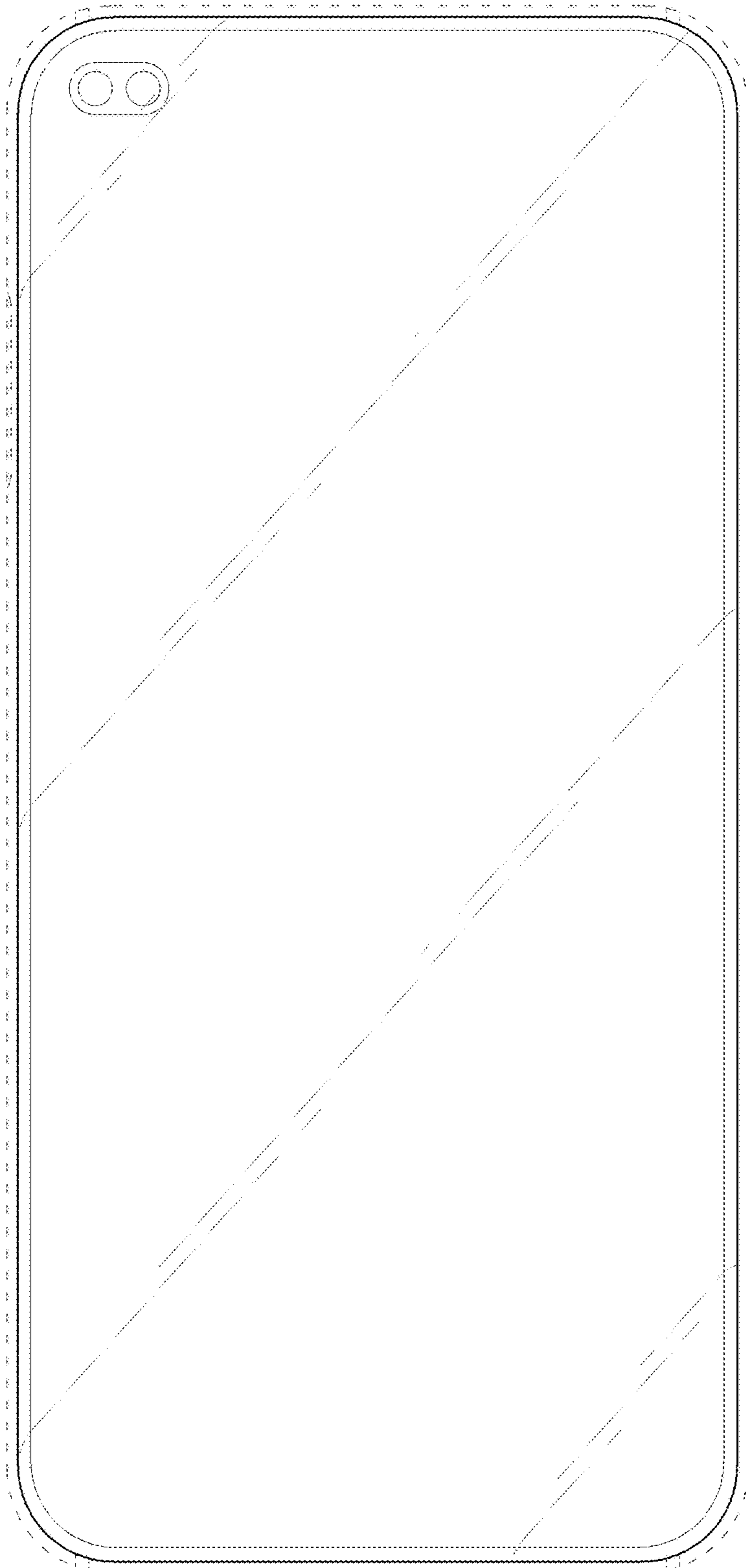

FIG. 43



FIG. 44

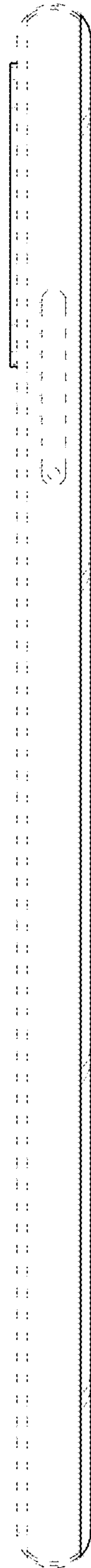

FIG. 45



FIG. 46

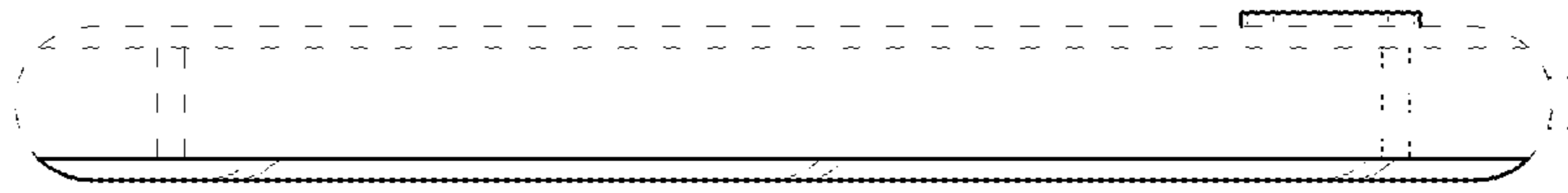

FIG. 47

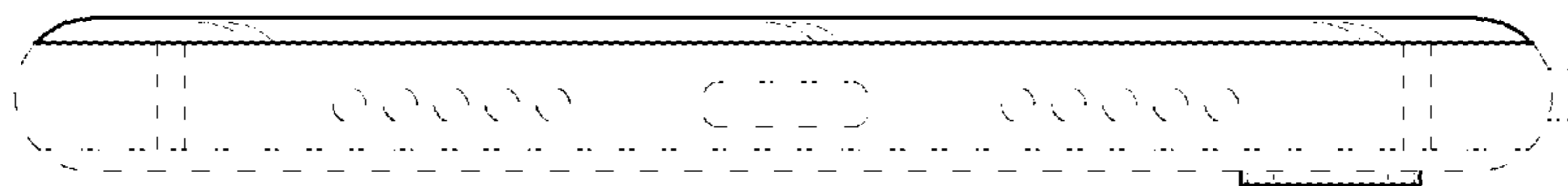

FIG. 48

