



US00D909990S

(12) **United States Design Patent** (10) **Patent No.:** **US D909,990 S**
Birger (45) **Date of Patent:** **** Feb. 9, 2021**

- (54) **HEADSET**
- (71) Applicant: **GN AUDIO A/S**, Ballerup (DK)
- (72) Inventor: **Johan Birger**, Ballerup (DK)
- (73) Assignee: **GN AUDIO A/S**, Ballerup (DK)
- (**) Term: **15 Years**
- (21) Appl. No.: **29/705,350**
- (22) Filed: **Sep. 11, 2019**

Related U.S. Application Data

- (62) Division of application No. 29/653,072, filed on Jun. 12, 2018, now Pat. No. Des. 876,386.

(30) **Foreign Application Priority Data**

Jan. 8, 2018 (EM) 004608016-0001

- (51) **LOC (13) Cl.** **14-01**
- (52) **U.S. Cl.**
USPC **D14/205**; D14/206
- (58) **Field of Classification Search**
USPC D14/205, 225, 226, 206, 218; D13/110,
D13/168; 455/90.3, 575.1, 569.1
CPC H04R 1/1033; H04R 1/10; H04R 1/1016;
H04R 1/1041; H04R 1/105; H04R
1/1091; H04R 1/1058; H04R 1/1075;
H04R 1/1066; H04R 5/033; H04R 5/0335
See application file for complete search history.

(56) **References Cited**

U.S. PATENT DOCUMENTS

- D278,234 S * 4/1985 Saito D14/205
- D318,670 S * 7/1991 Taniguchi D14/205
- D334,043 S * 3/1993 Taniguchi D14/218
- D433,404 S * 11/2000 Thakur D14/218

- D435,580 S * 12/2000 Grinkus D14/218
- D473,217 S * 4/2003 Rivera D14/223
- D519,108 S * 4/2006 Yang D14/223
- D539,782 S * 4/2007 Lee D14/188
- D587,681 S * 3/2009 Yanai D14/205
- D599,778 S * 9/2009 Ando D14/205
- D605,628 S 12/2009 Ando
- 7,639,824 B2 12/2009 Franzen
- D607,875 S 1/2010 Pedersen
- D625,292 S 10/2010 Andre
- 7,920,902 B2 * 4/2011 Carroll H04R 1/1008
455/569.1
- D656,492 S 3/2012 Huang
- 8,144,913 B1 3/2012 Myles
- D666,581 S 9/2012 Perez
- 8,290,193 B2 10/2012 Pang
- 8,314,354 B2 11/2012 Prest
- D681,001 S 4/2013 Murchison
- D683,334 S 5/2013 Gondo
- 8,447,062 B2 5/2013 Lin

(Continued)

Primary Examiner — Paula Allen Greene

(74) *Attorney, Agent, or Firm* — Hamre, Schumann,
Mueller & Larson, P.C.

(57) **CLAIM**

The ornamental design for a headset, as shown and described.

DESCRIPTION

FIG. 1 is a front elevational view of a headset showing my new design;
 FIG. 2 is a bottom perspective view of FIG. 1 thereof.
 FIG. 3 is a top view of FIG. 1 thereof.
 FIG. 4 is a partial left side view of FIG. 1 thereof.
 FIG. 5 is a partial right side view of FIG. 1 thereof.
 FIG. 6 is a back view of FIG. 1 thereof; and,
 FIG. 7 is a rear perspective view of FIG. 1 thereof.
 The features shown in broken lines depict environmental subject matter only and form no part of the claimed design.

1 Claim, 7 Drawing Sheets



(56)

References Cited

U.S. PATENT DOCUMENTS

D684,953 S 6/2013 Schaa
 D685,764 S 7/2013 Coulter
 D698,750 S 2/2014 Yoon
 8,655,006 B2 2/2014 Aase
 8,743,533 B2* 6/2014 Stanley H01H 9/0228
 361/679.01
 D712,371 S 9/2014 Henning
 D715,253 S 10/2014 Lee
 D716,272 S 10/2014 Yang
 D722,040 S* 2/2015 Tan D14/205
 D726,145 S 4/2015 Hsieh
 D727,871 S 4/2015 Orbach
 9,031,264 B2 5/2015 Yang
 D731,456 S 6/2015 Dahlberg
 D743,381 S 11/2015 Pi
 D758,353 S 6/2016 Akana
 D764,436 S 8/2016 Dryden
 D776,083 S 1/2017 Lee
 D777,138 S 1/2017 Fletcher
 D777,139 S 1/2017 Fletcher
 D782,992 S 4/2017 Ahlstrom
 D786,216 S 5/2017 Silva
 D793,995 S 8/2017 Nakagawa
 D796,473 S 9/2017 Kim
 D800,703 S 10/2017 Vaclavik
 D812,038 S 3/2018 Nakajima
 D816,059 S 4/2018 Liu
 D817,301 S 5/2018 Aoyagi
 9,980,032 B2 5/2018 Yajima
 D820,810 S 6/2018 Levine
 D821,362 S 6/2018 Vaclavik

D821,999 S 7/2018 Guo
 D830,992 S* 10/2018 Hardi D14/205
 D830,994 S* 10/2018 Lee D14/205
 D839,238 S 1/2019 Hu
 D840,972 S* 2/2019 Luo D14/205
 D844,586 S 4/2019 Sweet
 D845,272 S* 4/2019 Birger D14/205
 D845,926 S* 4/2019 Aoyagi D14/205
 D850,407 S* 6/2019 Li D14/205
 D865,707 S* 11/2019 Bian D14/205
 D873,791 S* 1/2020 Aoyagi D14/205
 D875,070 S* 2/2020 Carr D14/205
 D876,386 S* 2/2020 Birger D14/205
 D881,838 S* 4/2020 Aoyagi D14/205
 D882,545 S* 4/2020 Li D14/205
 D886,077 S* 6/2020 Chen D14/205
 D890,126 S* 7/2020 Lee D14/205
 D890,127 S* 7/2020 Kim D14/205
 D890,128 S* 7/2020 Kim D14/205
 D894,152 S* 8/2020 Sweet D14/205
 D895,569 S* 9/2020 Roberts D14/205
 D896,202 S* 9/2020 Mo D14/205
 2010/0104126 A1 4/2010 Greene
 2011/0142276 A1 6/2011 Uchida
 2012/0170789 A1 7/2012 Lin
 2013/0077815 A1 3/2013 Stephenson
 2016/0142808 A1 5/2016 Monahan
 2016/0261946 A1 9/2016 Chen
 2017/0295421 A1 10/2017 Hung
 2018/0027318 A1 1/2018 Witt
 2018/0070165 A1* 3/2018 Hatfield H04R 1/1016
 2018/0199128 A1 7/2018 Chiu
 2019/0306609 A1* 10/2019 Lee H04R 1/1066

* cited by examiner

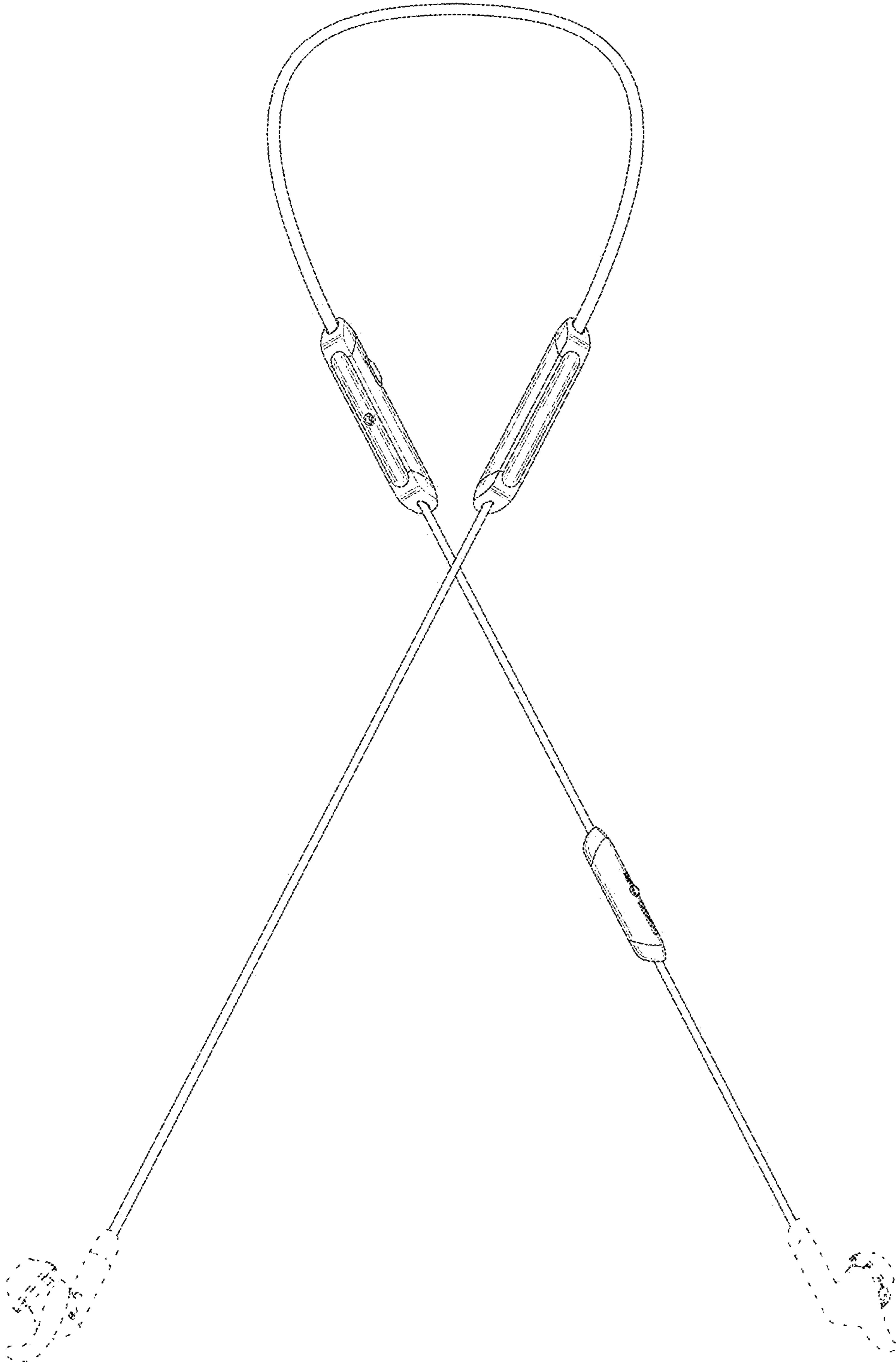

FIG. 1

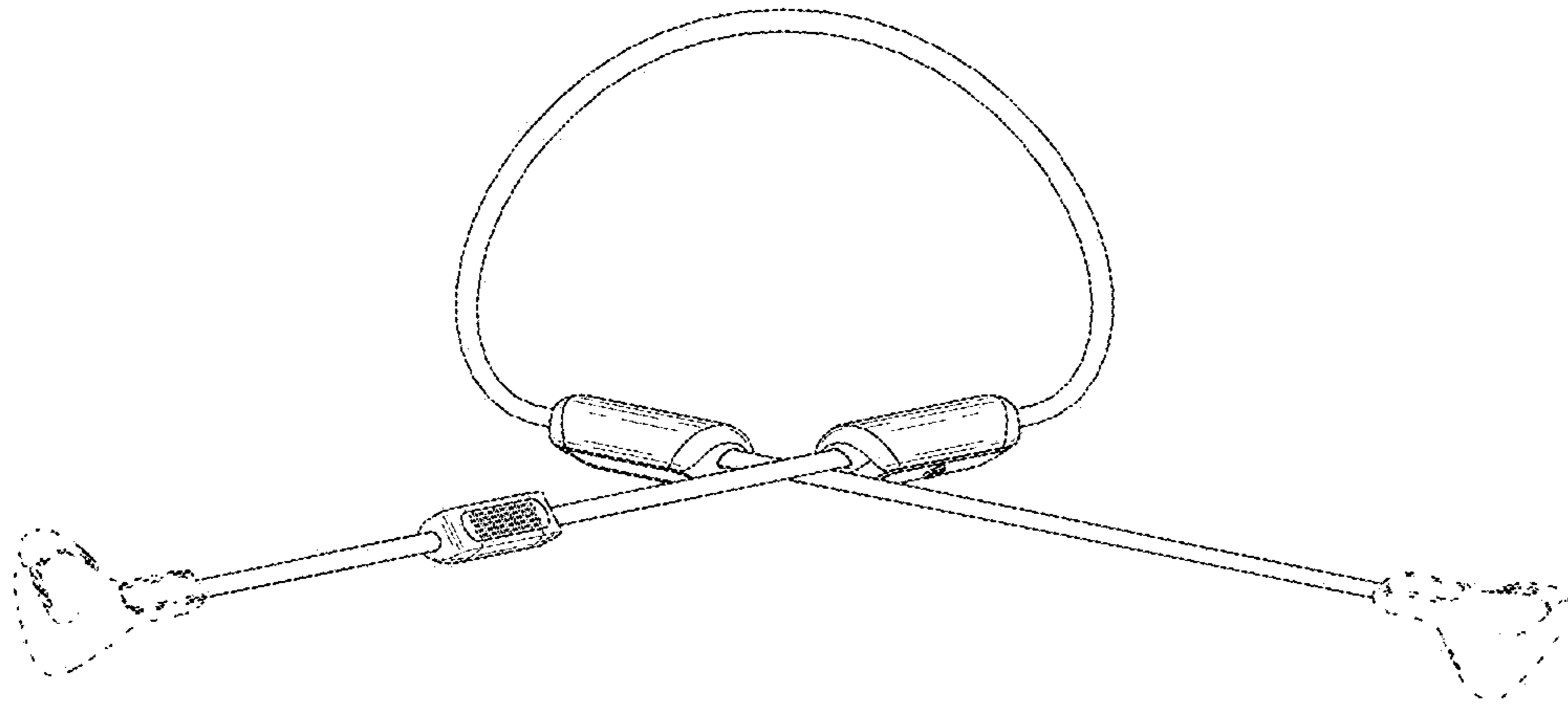

FIG. 2

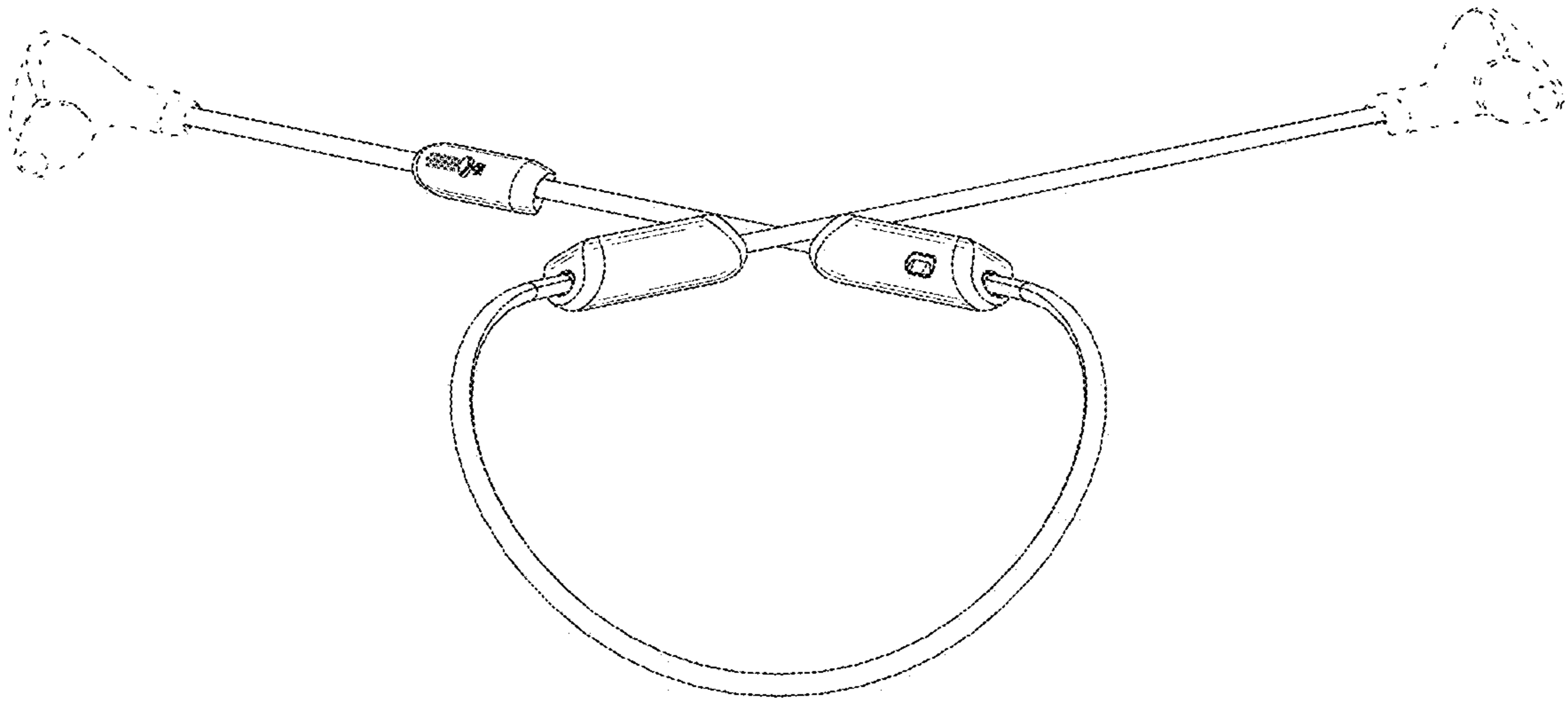

FIG. 3

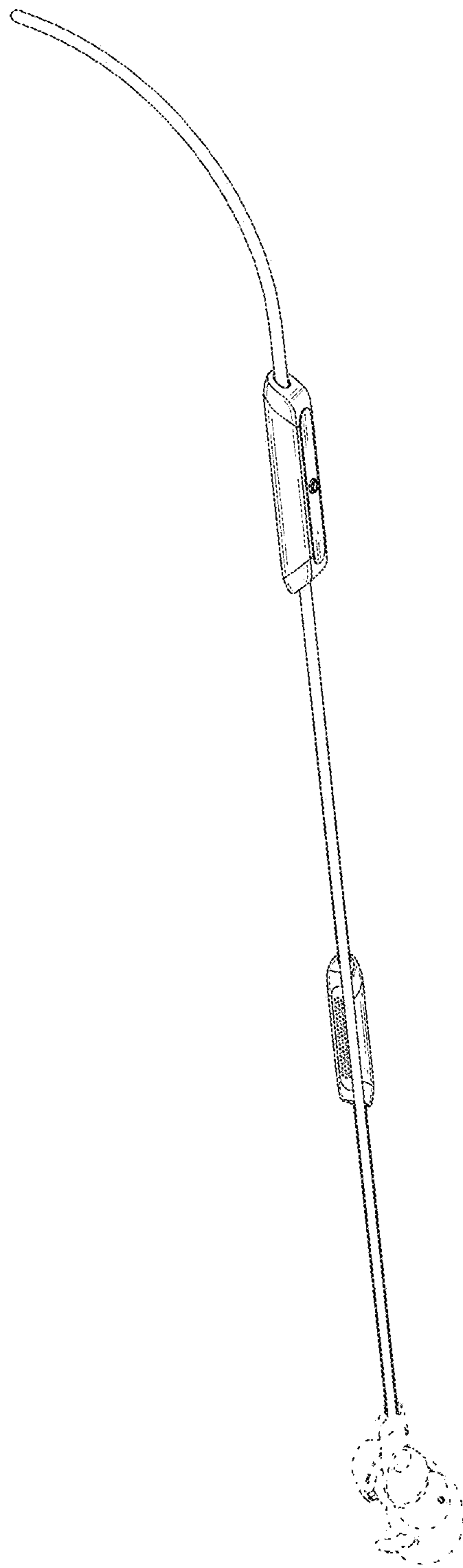

FIG. 4

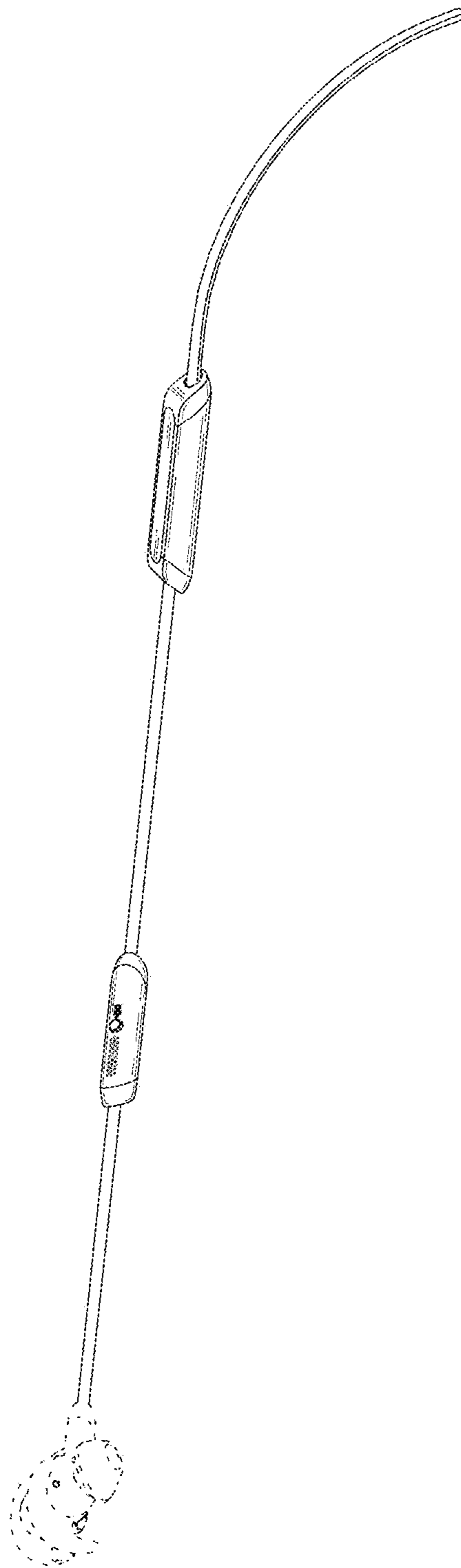

FIG. 5

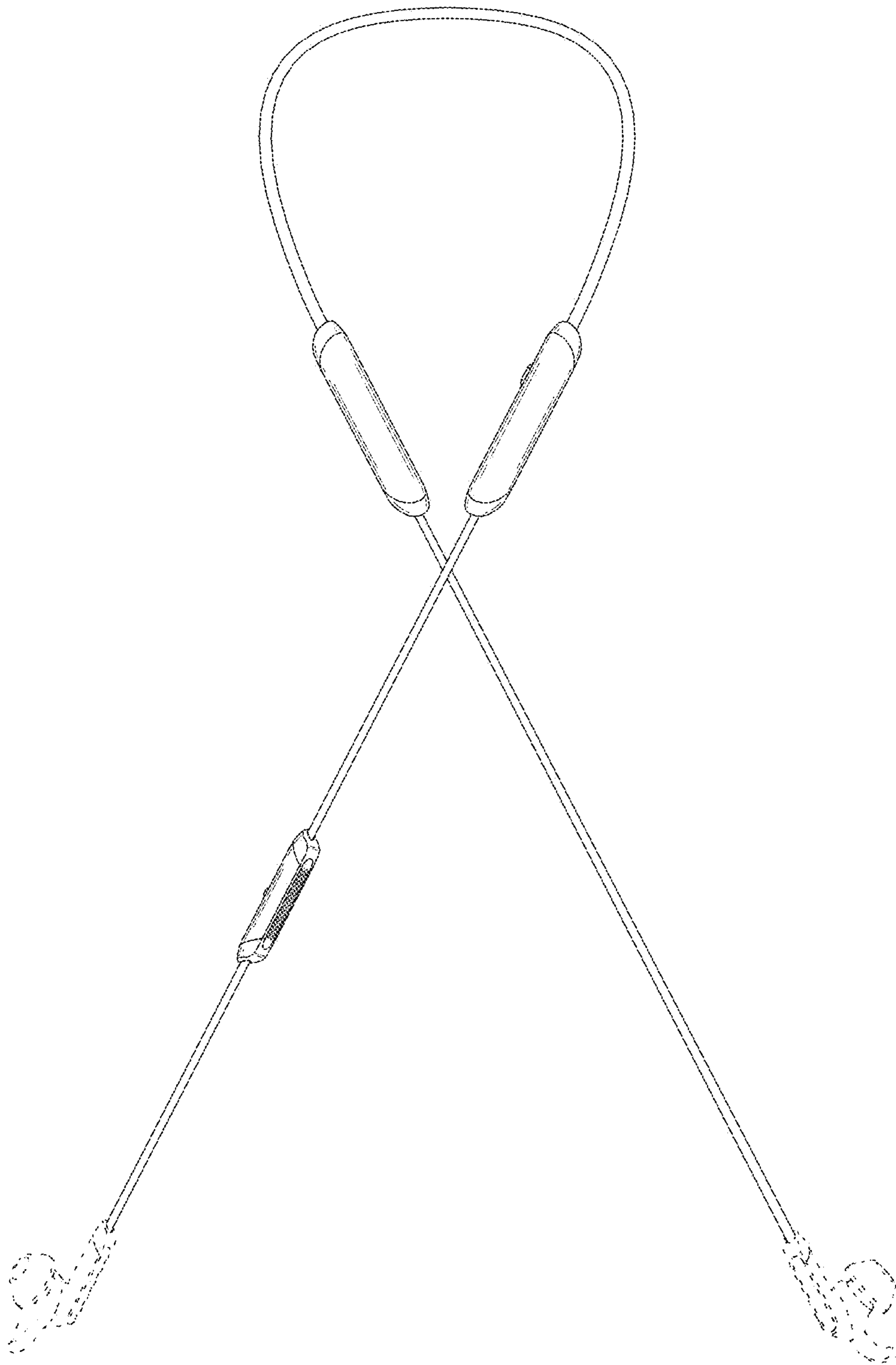

FIG. 6

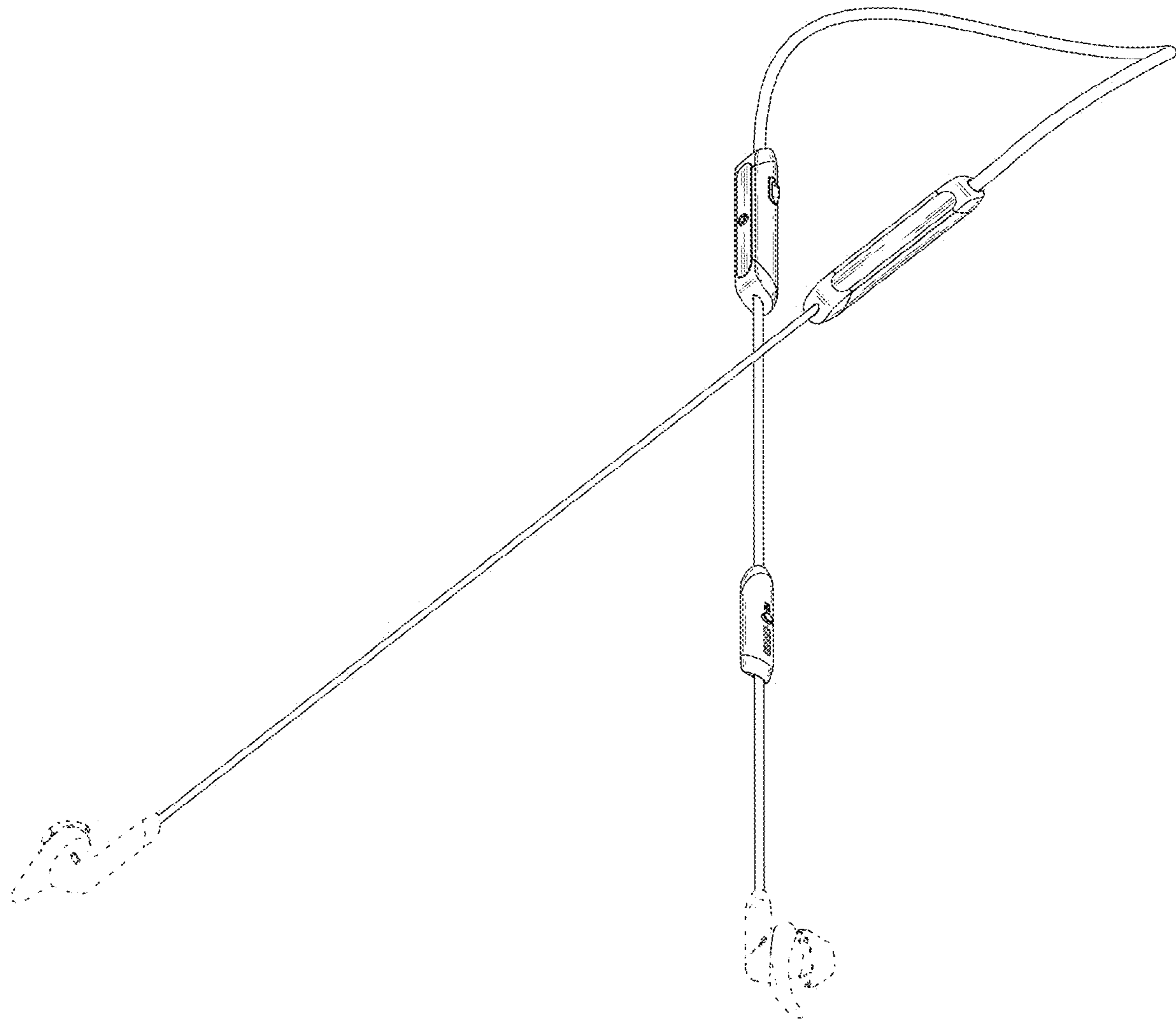

FIG. 7