



US00D909970S

(12) **United States Design Patent** (10) **Patent No.:** **US D909,970 S**  
**Jokinen** (45) **Date of Patent:** **\*\* Feb. 9, 2021**

(54) **POWER SUPPLY**

(71) Applicant: **Petteri Jokinen**, Lahti (FI)  
(72) Inventor: **Petteri Jokinen**, Lahti (FI)  
(73) Assignee: **KEMPOWER OY**, Lahti (FI)

(\*\*) Term: **15 Years**

(21) Appl. No.: **29/705,932**

(22) Filed: **Sep. 17, 2019**

(51) **LOC (13) Cl.** ..... **13-02**

(52) **U.S. Cl.**  
USPC ..... **D13/110**

(58) **Field of Classification Search**  
USPC ..... D13/103, 107, 108, 110, 112, 113, 114,  
D13/117, 118, 119, 122, 184, 199;  
D14/300, 301, 308, 313  
CPC ..... H02B 1/26; H02K 5/00; H02K 11/0094  
See application file for complete search history.

(56) **References Cited**

**U.S. PATENT DOCUMENTS**

D418,808 S *	1/2000	Lee	.....	D13/110
D431,810 S *	10/2000	Weng	.....	D13/110
D436,075 S *	1/2001	Chou	.....	D13/110
6,246,580 B1 *	6/2001	Weng	.....	G06F 1/18 174/16.1
D485,835 S *	1/2004	Ritson	.....	D14/300
D679,272 S *	4/2013	Frost	.....	D14/313
D698,724 S *	2/2014	Palatini	.....	D13/110
D786,793 S *	5/2017	Lin	.....	D13/110
D805,032 S *	12/2017	Folk	.....	D13/110
D887,978 S *	6/2020	Fidler	.....	D13/110
D894,892 S *	9/2020	Andersson	.....	D14/300
2003/0123222 A1 *	7/2003	Thompson	.....	H05K 7/20581 361/679.48

(Continued)

**FOREIGN PATENT DOCUMENTS**

IN 321702-001 \* 3/2020

**OTHER PUBLICATIONS**

“Chenbro Server Chassis”. Found online Sep. 10, 2020 at varinsights.com. Reference dated Apr. 7, 2014. Retrieved from https://www.varinsights.com/doc/chenbro-customized-chassis-broadcast-professionals-harness-power-0001. (Year: 2014).\*

(Continued)

*Primary Examiner* — Kendra Leslie Hamilton

*Assistant Examiner* — Amanda Christensen

(74) *Attorney, Agent, or Firm* — Thompson Hine LLP

(57) **CLAIM**

The ornamental design for a power supply, as shown and described.

**DESCRIPTION**

FIG. 1 is a top, front, left perspective view of a first embodiment of a power supply, showing my new design; FIG. 2 is a top, rear, left perspective view thereof; FIG. 3 is a front elevation view thereof; FIG. 4 is a rear elevation view thereof; FIG. 5 is a right side elevation view thereof; FIG. 6 is a left side elevation view thereof; FIG. 7 is a top plan view thereof; FIG. 8 is a bottom plan view thereof; FIG. 9 is a top, front, left perspective view of a second embodiment of a power supply, showing my new design; FIG. 10 is a top, rear, left perspective view thereof; FIG. 11 is a front elevation view thereof; FIG. 12 is a rear elevation view thereof; FIG. 13 is a right side elevation view thereof; FIG. 14 is a left side elevation view thereof; FIG. 15 top plan view thereof; and, FIG. 16 is a bottom plan view thereof. The broken lines depict portions of the power supply that form no part of the claimed design.

**1 Claim, 16 Drawing Sheets**

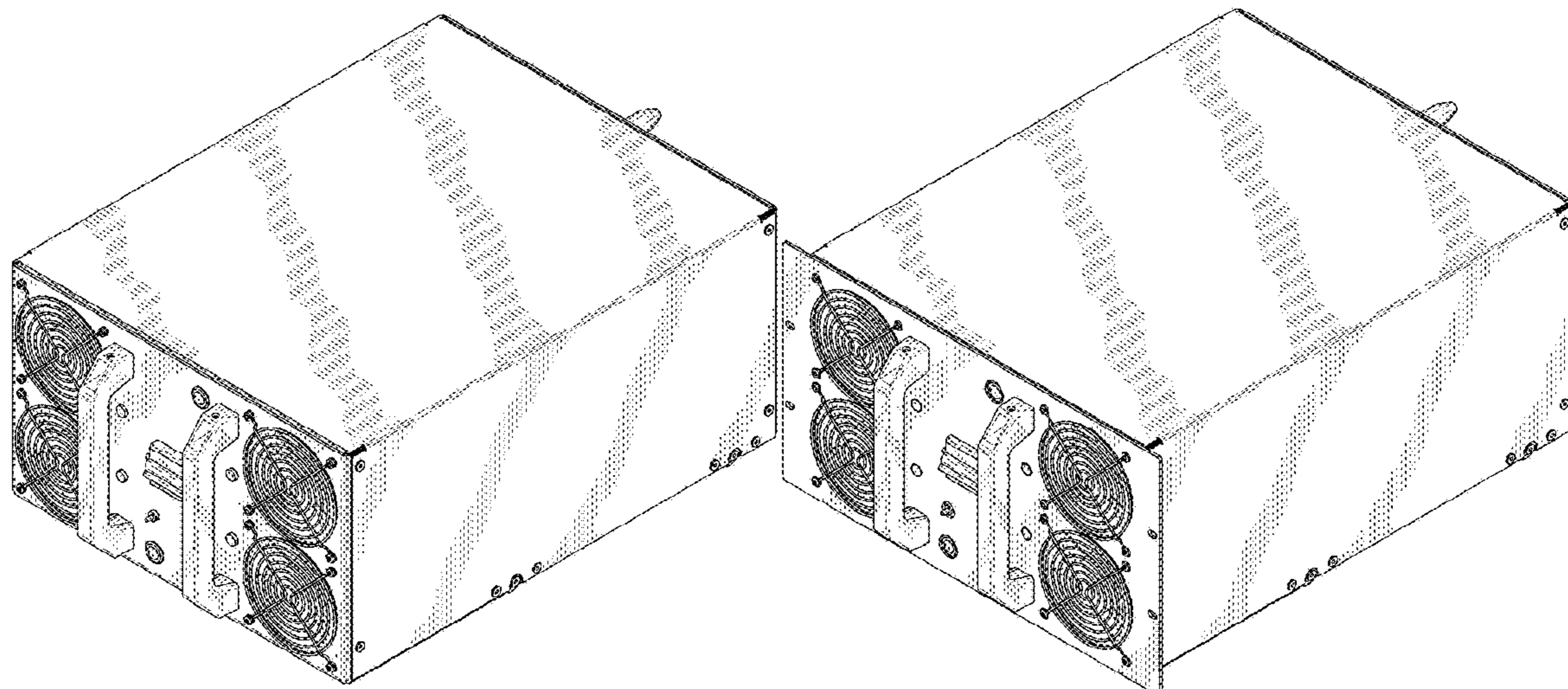

(56)

**References Cited**

U.S. PATENT DOCUMENTS

2005/0088825 A1\* 4/2005 Miyamura ..... G06F 1/188  
361/715

OTHER PUBLICATIONS

“Rosewill Server Chassis”. Found online Sep. 10, 2020 at amazon.com. Reference dated Aug. 23, 2012. Retrieved from <https://www.amazon.com/Rosewill-Rackmount-Computer-Pre-Installed-RSV-L4500/dp/B0091IZ1ZG>. (Year: 2012).\*

“Dell Assy Power Supply”. Found online Sep. 21, 2020 at amazon.com. Reference dated Jun. 16, 2014. Retrieved from [https://www.amazon.com/Dell-Assy-Power-Supply-N24MJ/dp/B00L16RASC/ref=pd\\_day0\\_23\\_1/147-1685015-2055246](https://www.amazon.com/Dell-Assy-Power-Supply-N24MJ/dp/B00L16RASC/ref=pd_day0_23_1/147-1685015-2055246). (Year: 2014).\*

Excerpt from web page for Hypercharger HYC 225 and HYC 300 by Alpitronic GmbH, 1 page, <https://www.hypercharger.it/products/> (2018).

Product Brief for Hypercharger 225/Hypercharger 300, by Alpitronic GmbH, 5 pages, [http://www.hypercharger.it/wp-content/uploads/2018/06/HYC\\_225\\_300\\_produktdbrief\\_v20180513.pdf](http://www.hypercharger.it/wp-content/uploads/2018/06/HYC_225_300_produktdbrief_v20180513.pdf) (2018).

\* cited by examiner

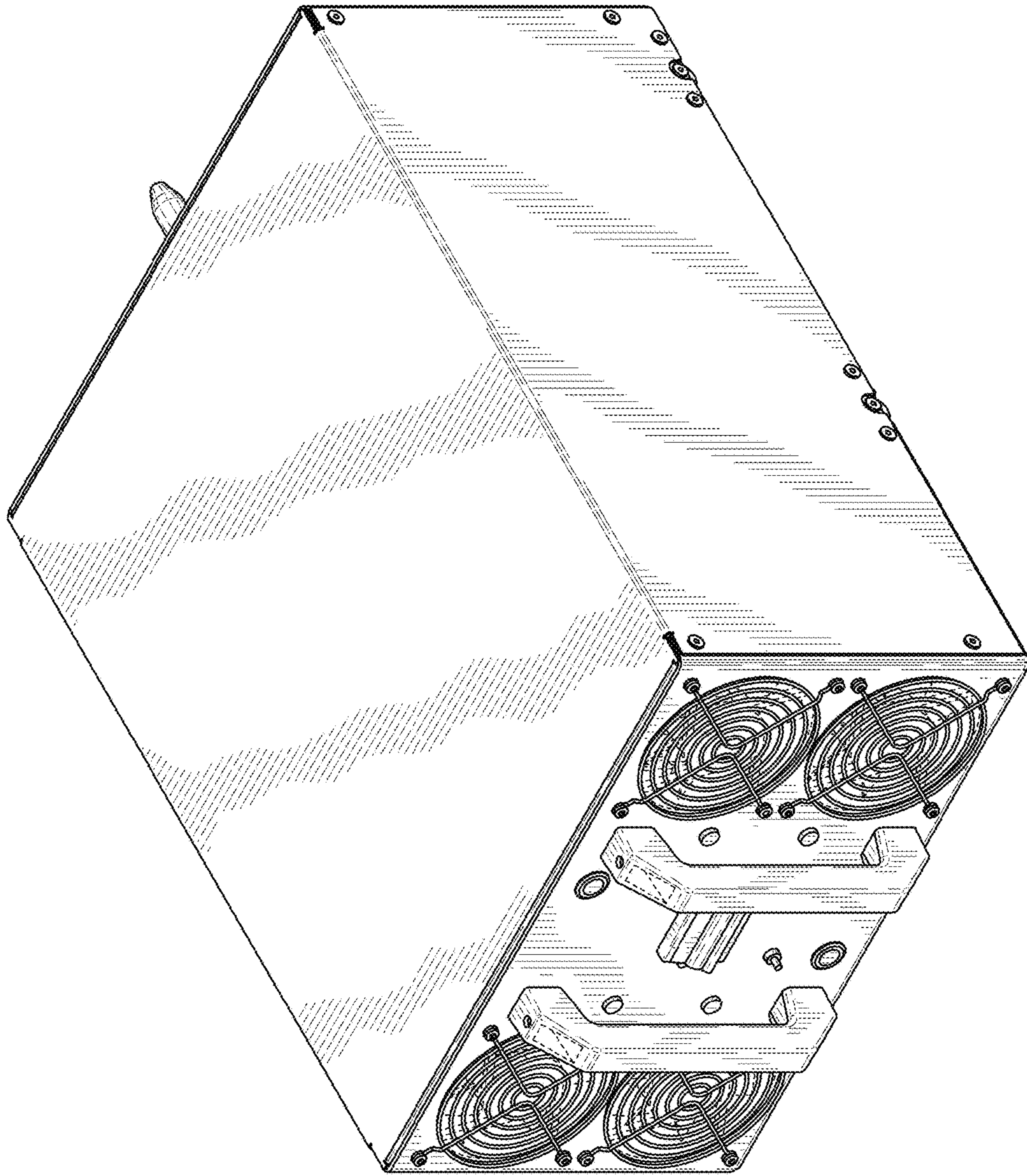

FIG. 1

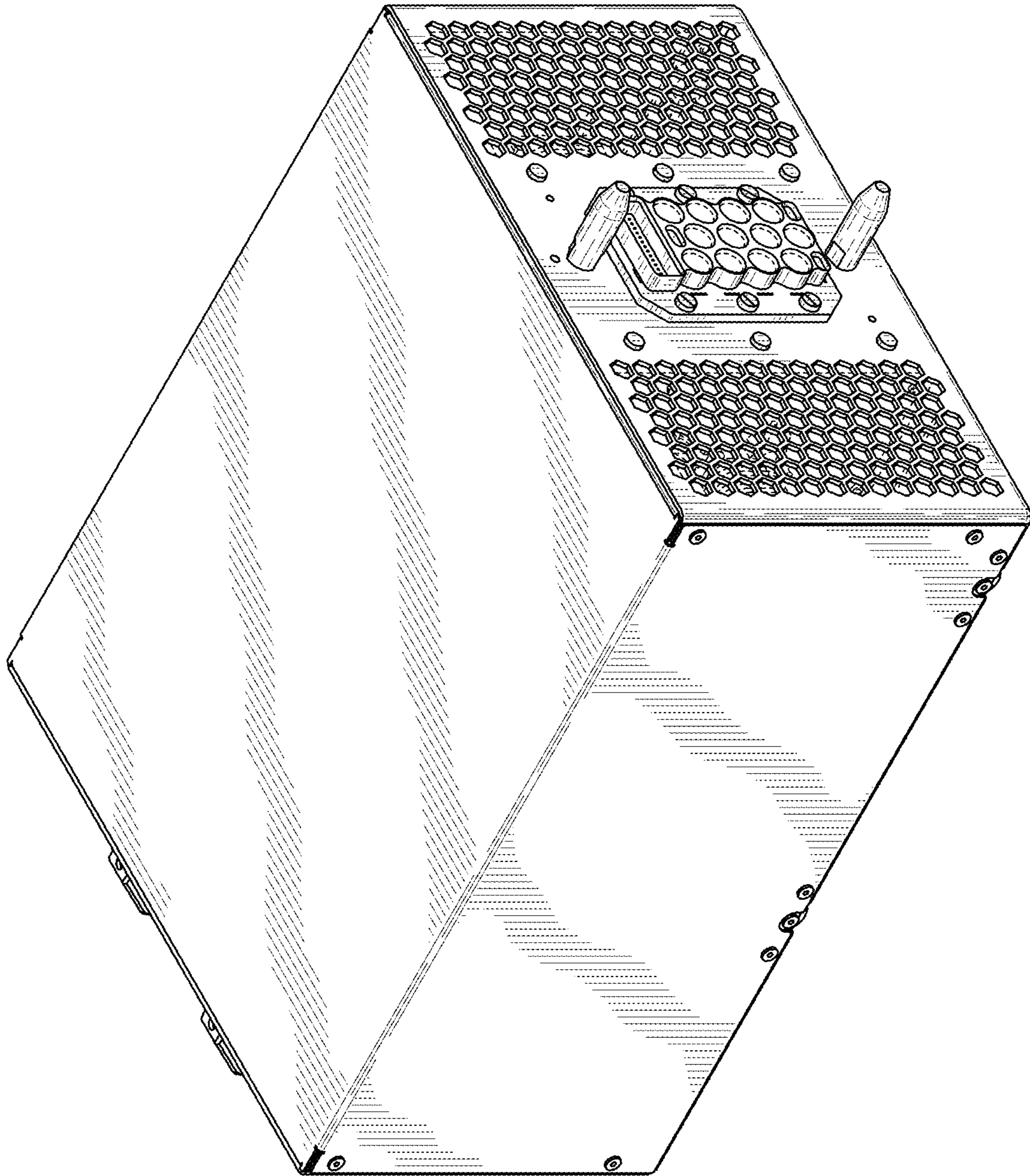

FIG. 2

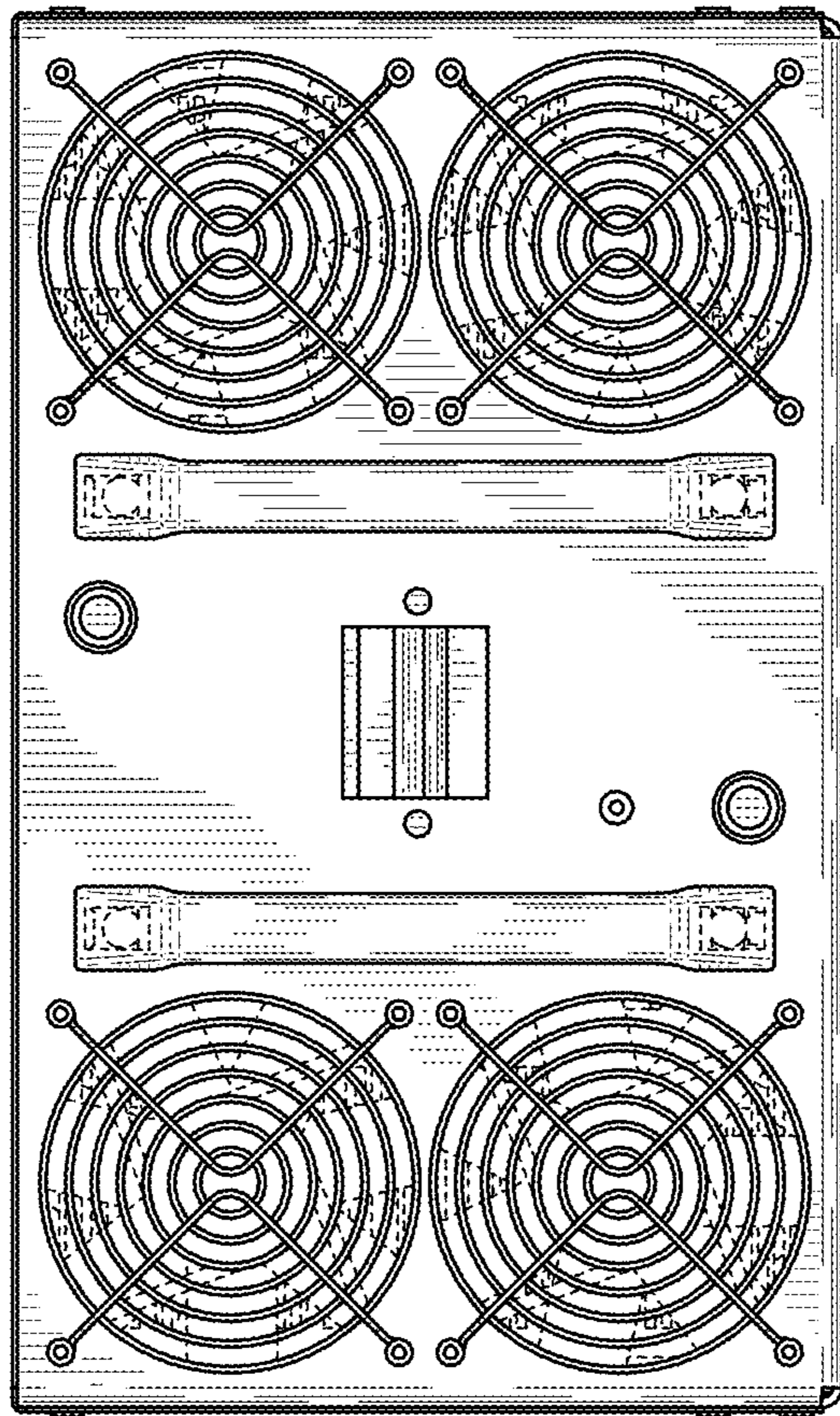

FIG. 3

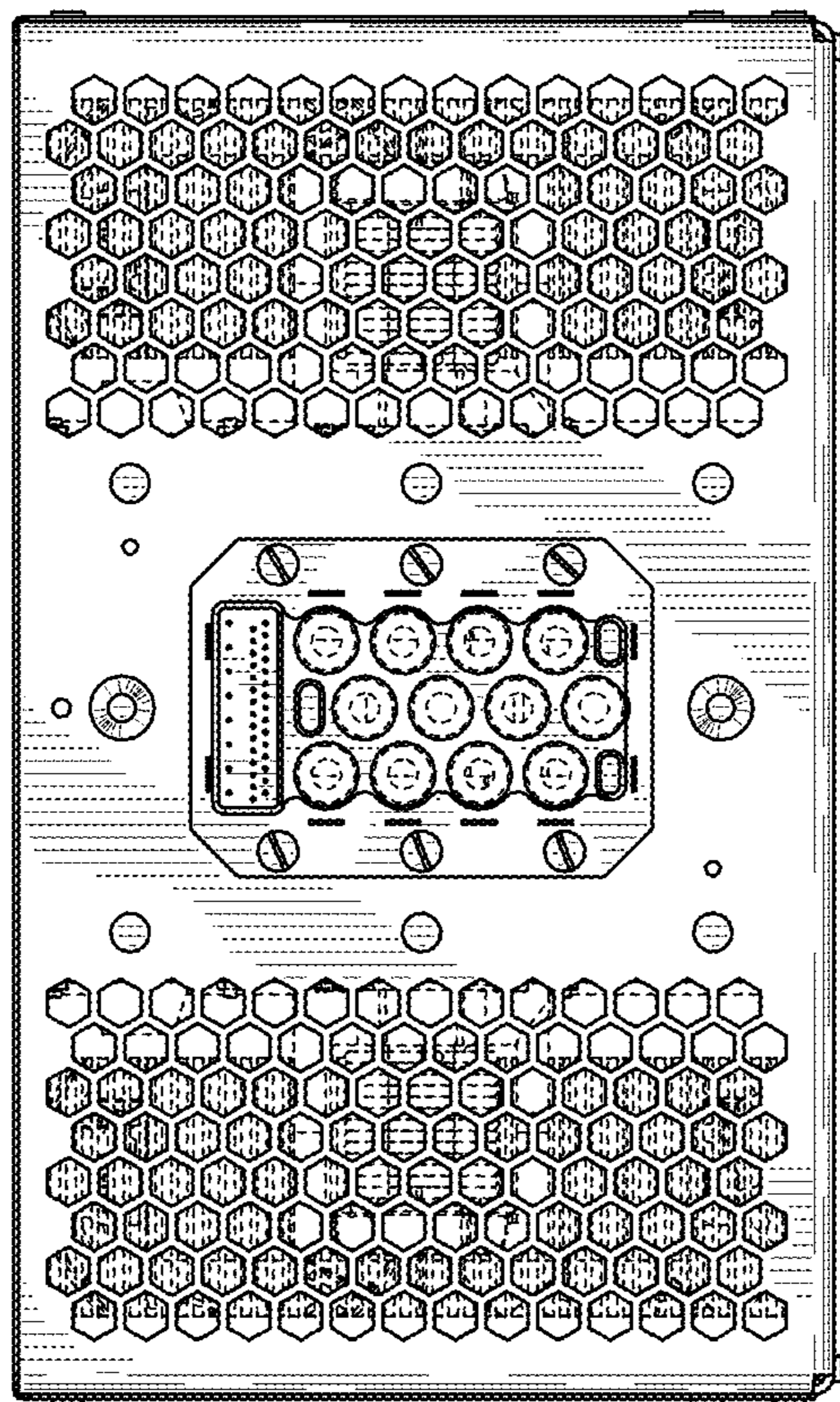

FIG. 4

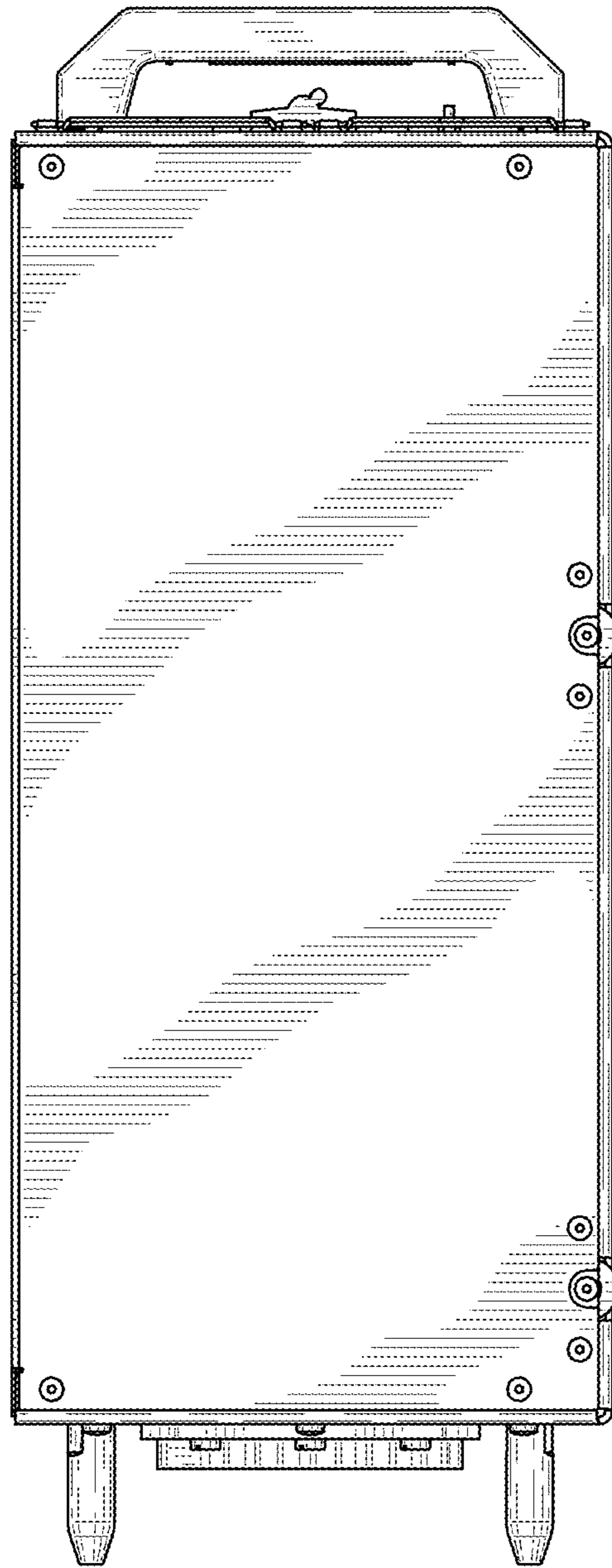

FIG. 5

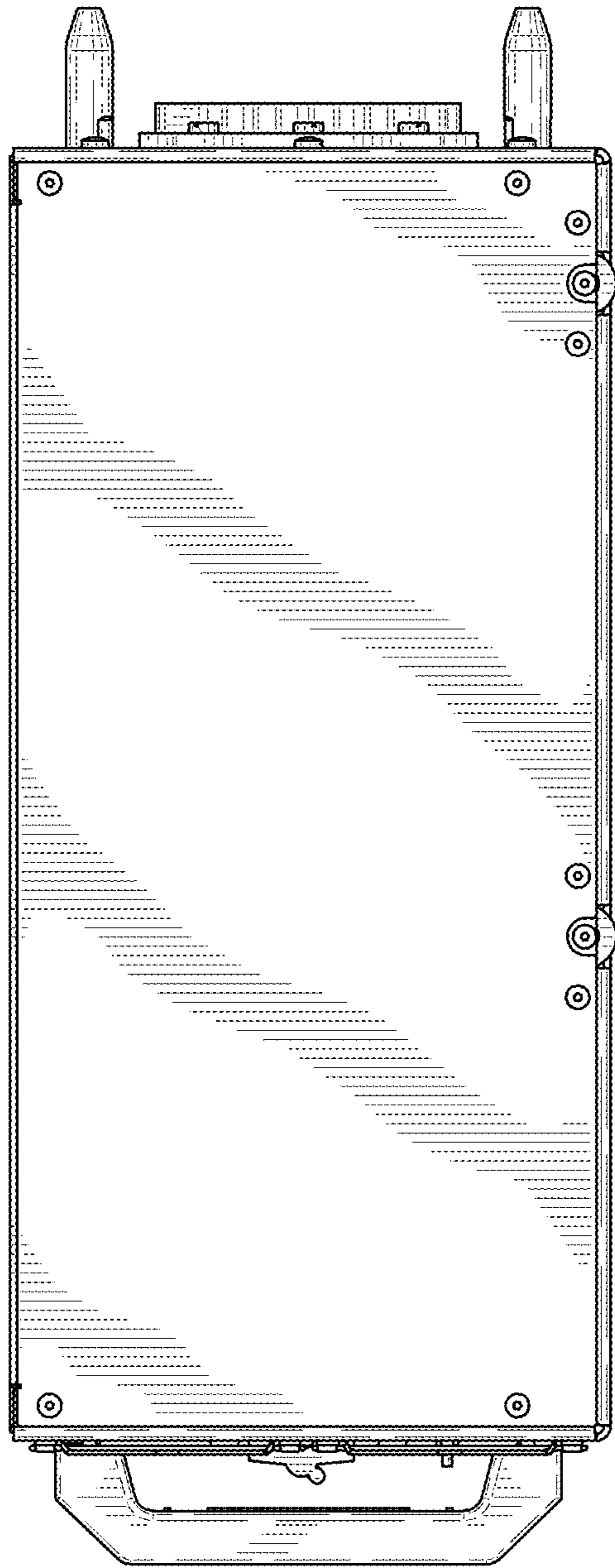

FIG. 6





FIG. 7

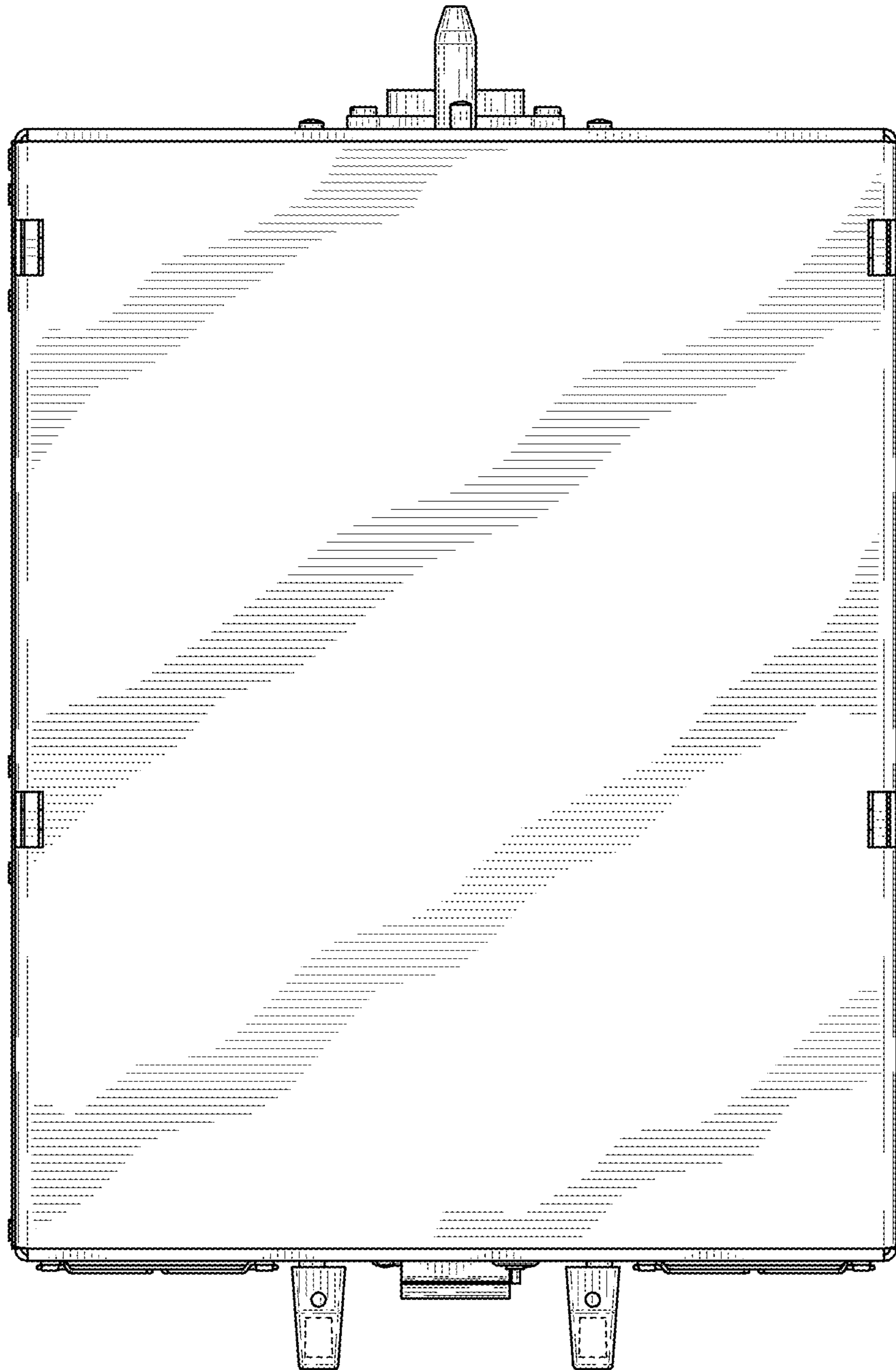

FIG. 8

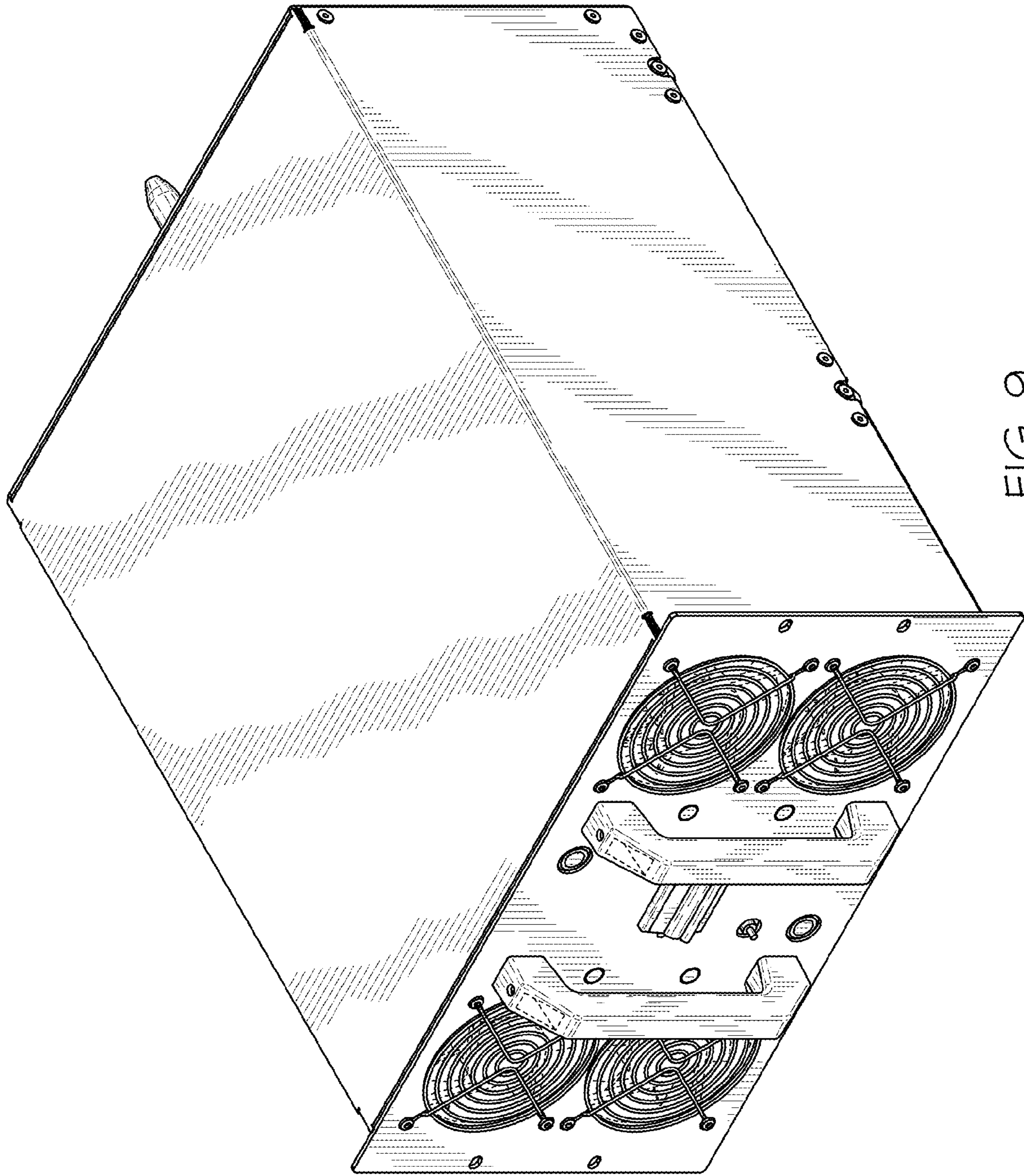

FIG. 9

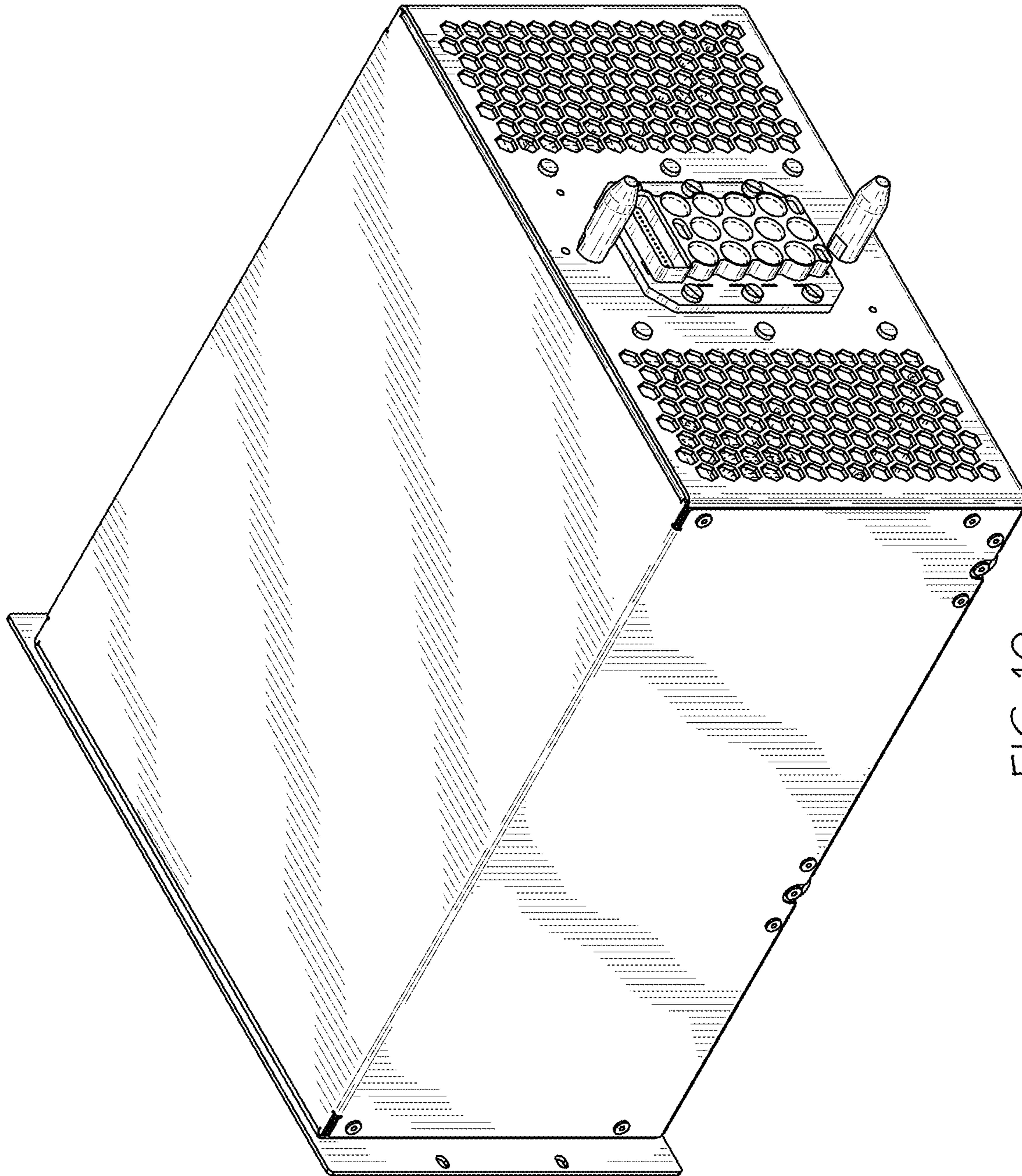

FIG. 10

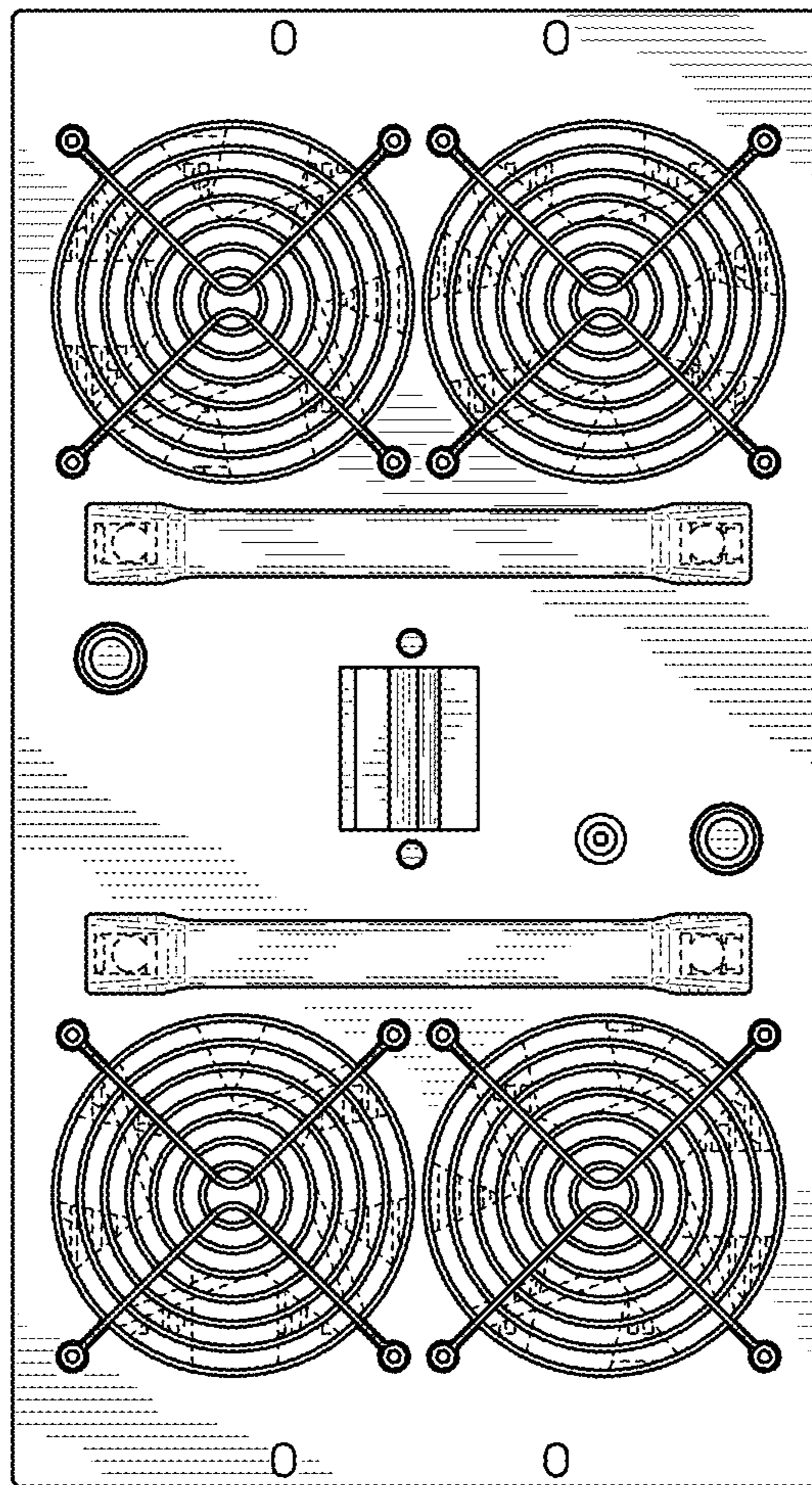

FIG. 11

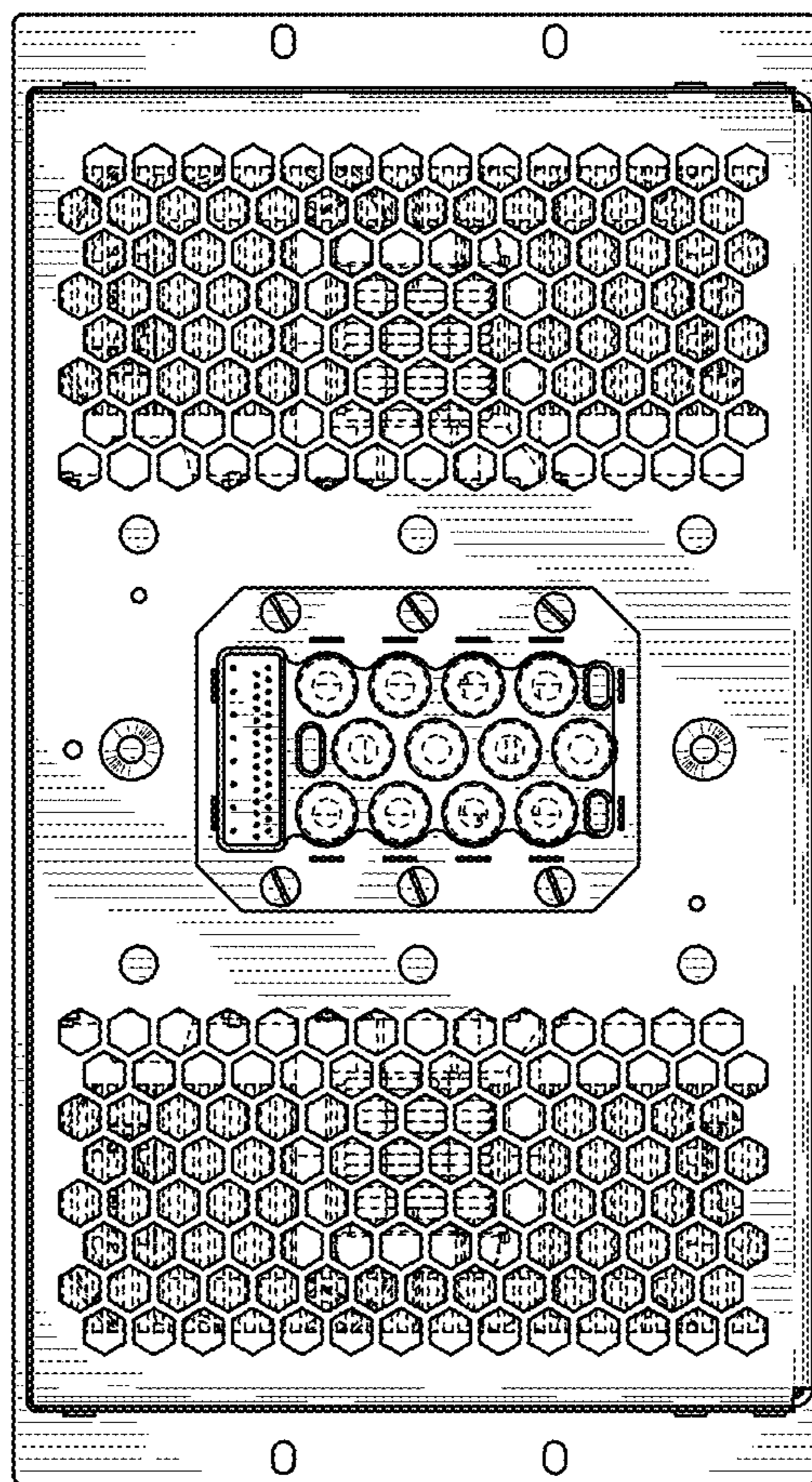

FIG. 12

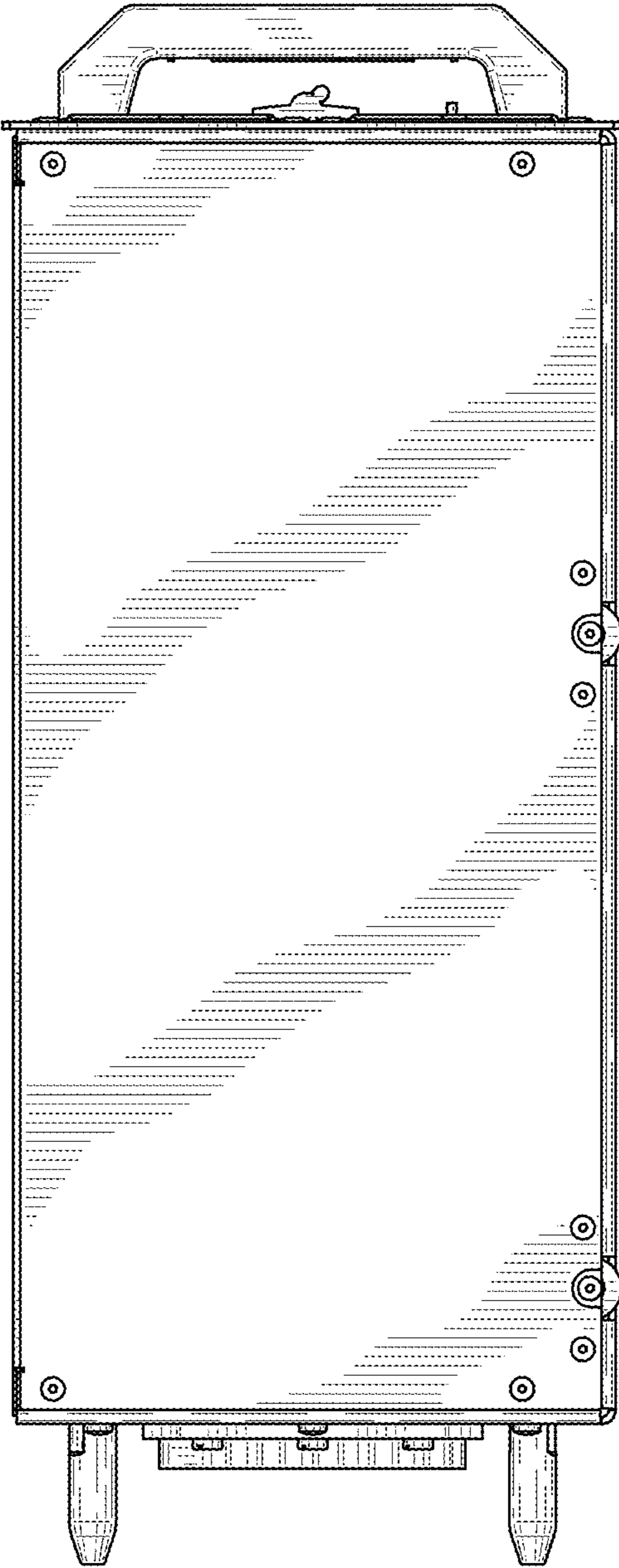

FIG. 13

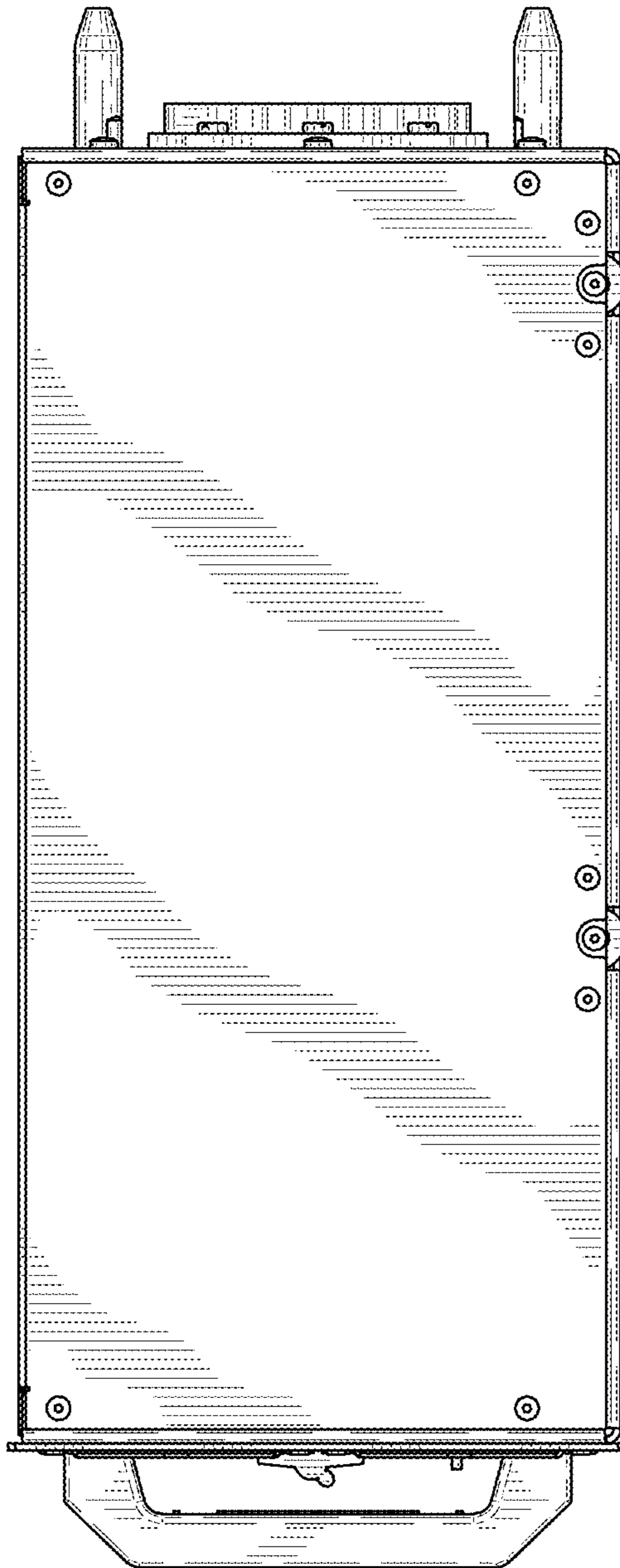

FIG. 14



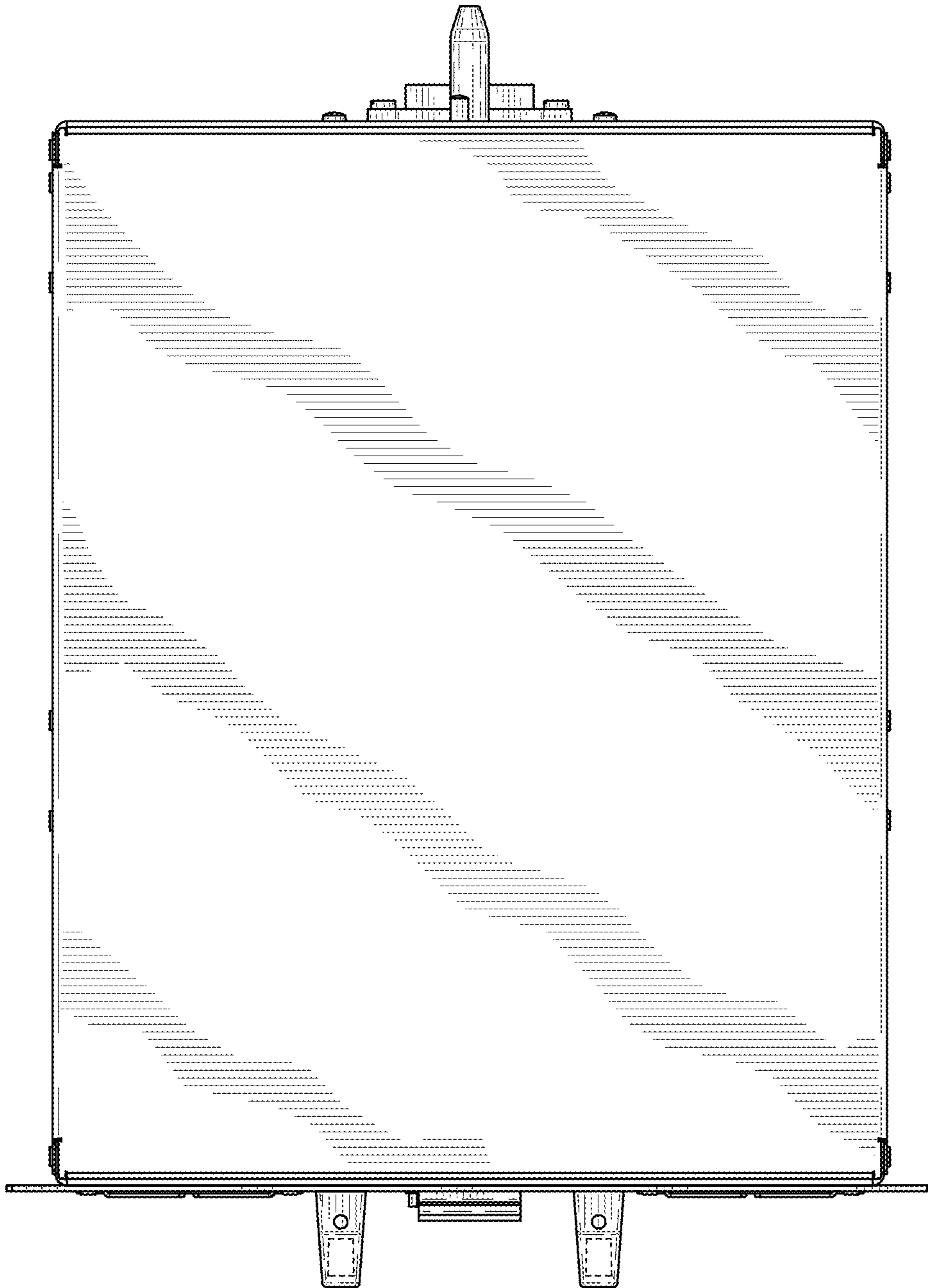

FIG. 15

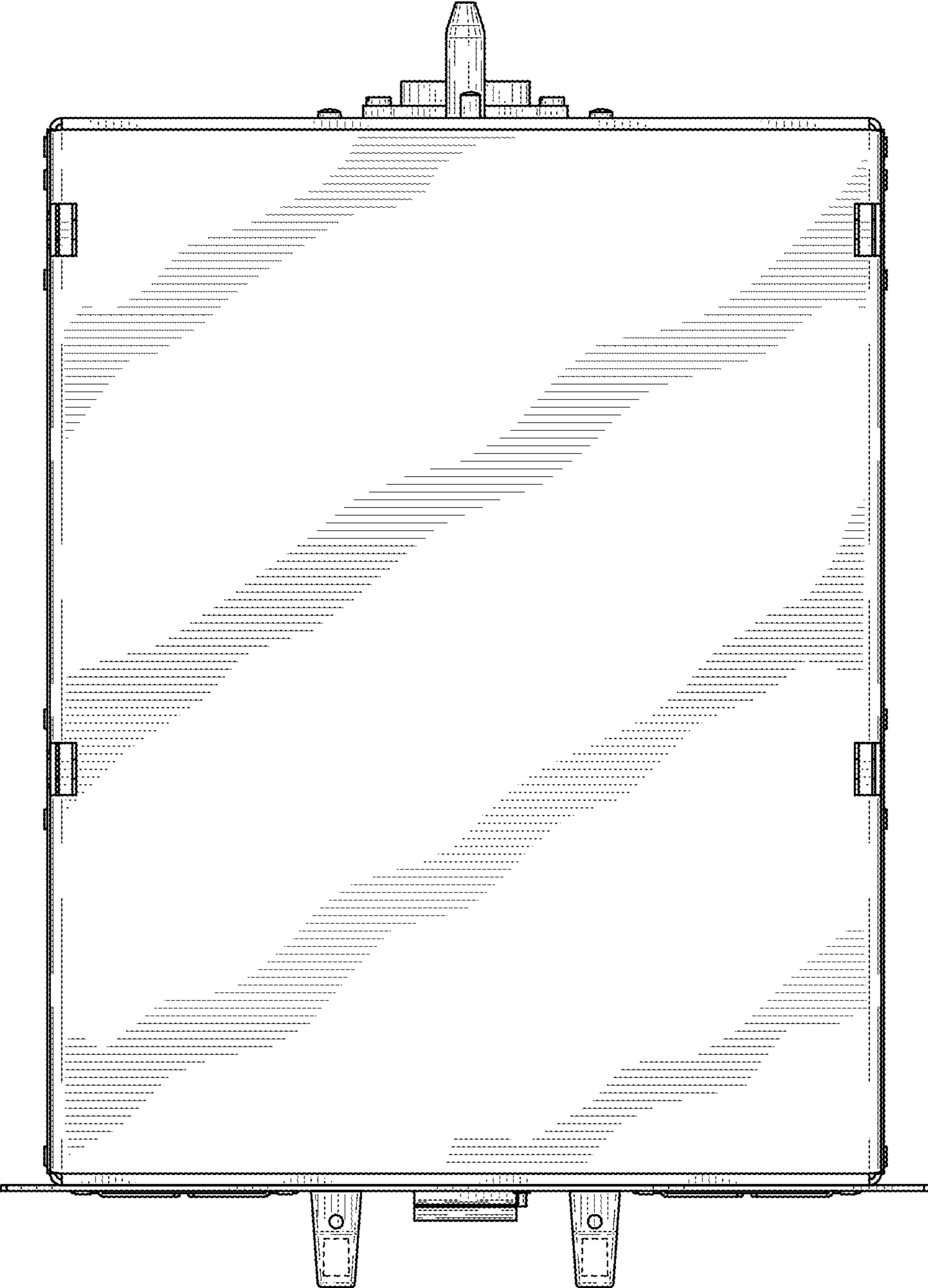

FIG. 16