



US00D909874S

(12) **United States Design Patent** (10) **Patent No.:** **US D909,874 S**
Lee (45) **Date of Patent:** **** Feb. 9, 2021**

(54) **PACKAGING CONTAINER**
(71) Applicant: **LG HOUSEHOLD & HEALTH CARE LTD.**, Seoul (KR)
(72) Inventor: **Dalin Lee**, Seoul (KR)
(73) Assignee: **LG HOUSEHOLD & HEALTH CARE LTD.**, Seoul (KR)

(**) Term: **15 Years**
(21) Appl. No.: **29/732,054**
(22) Filed: **Apr. 21, 2020**

(30) **Foreign Application Priority Data**
Oct. 31, 2019 (KR) 30-2019-0051914
(51) **LOC (13) Cl.** **09-01**
(52) **U.S. Cl.**
USPC **D9/503**; D9/452; D9/454; D9/504
(58) **Field of Classification Search**
USPC D9/414, 434-435, 452, 454, 500,
D9/503-504, 516, 529, 549, 558, 715,
D9/719; D28/73, 76
CPC B65D 1/00; B65D 1/02; B65D 1/0223;
B65D 23/00; B65D 51/32; B65D
2501/00; B65D 2501/0009
See application file for complete search history.

(56) **References Cited**
U.S. PATENT DOCUMENTS
D311,328 S * 10/1990 van der Tang D9/436
D509,739 S * 9/2005 Haruta D9/504
D522,367 S * 6/2006 Bakic D9/504
D530,572 S * 10/2006 Daams D7/615

D557,607 S * 12/2007 Misawa D9/503
D610,459 S * 2/2010 Nagata D9/504
D615,874 S * 5/2010 Nagata D9/689
D619,896 S * 7/2010 Iwazu D9/504
D634,638 S * 3/2011 L'Abbate D9/529
D634,639 S * 3/2011 L'Abbate D9/529
D635,030 S * 3/2011 L'Abbate D9/529
D638,300 S * 5/2011 L'Abbate D9/529
D643,743 S * 8/2011 Yu D9/689
D645,746 S * 9/2011 Yu D9/503
D645,749 S * 9/2011 Lee D9/504
D645,750 S * 9/2011 Lee D9/504
D680,443 S * 4/2013 You D9/691
D683,225 S * 5/2013 Servaire D9/542
D683,238 S * 5/2013 You D9/688
D697,805 S * 1/2014 You D9/503
D801,184 S * 10/2017 Trevino D9/600
D845,132 S * 4/2019 Otani D9/503
D869,281 S * 12/2019 Metais D9/504

* cited by examiner
Primary Examiner — Dana Meyrow
(74) *Attorney, Agent, or Firm* — Birch, Stewart, Kolasch & Birch, LLP

(57) **CLAIM**
The ornamental design for a packaging container, as shown and described.

DESCRIPTION
FIG. 1 is a front perspective view of the packaging container showing our new design;
FIG. 2 is a front view thereof;
FIG. 3 is a rear view thereof;
FIG. 4 is a left side view thereof;
FIG. 5 is a right side view thereof;
FIG. 6 is a top plan view thereof; and,
FIG. 7 is a bottom plan view thereof.

1 Claim, 7 Drawing Sheets

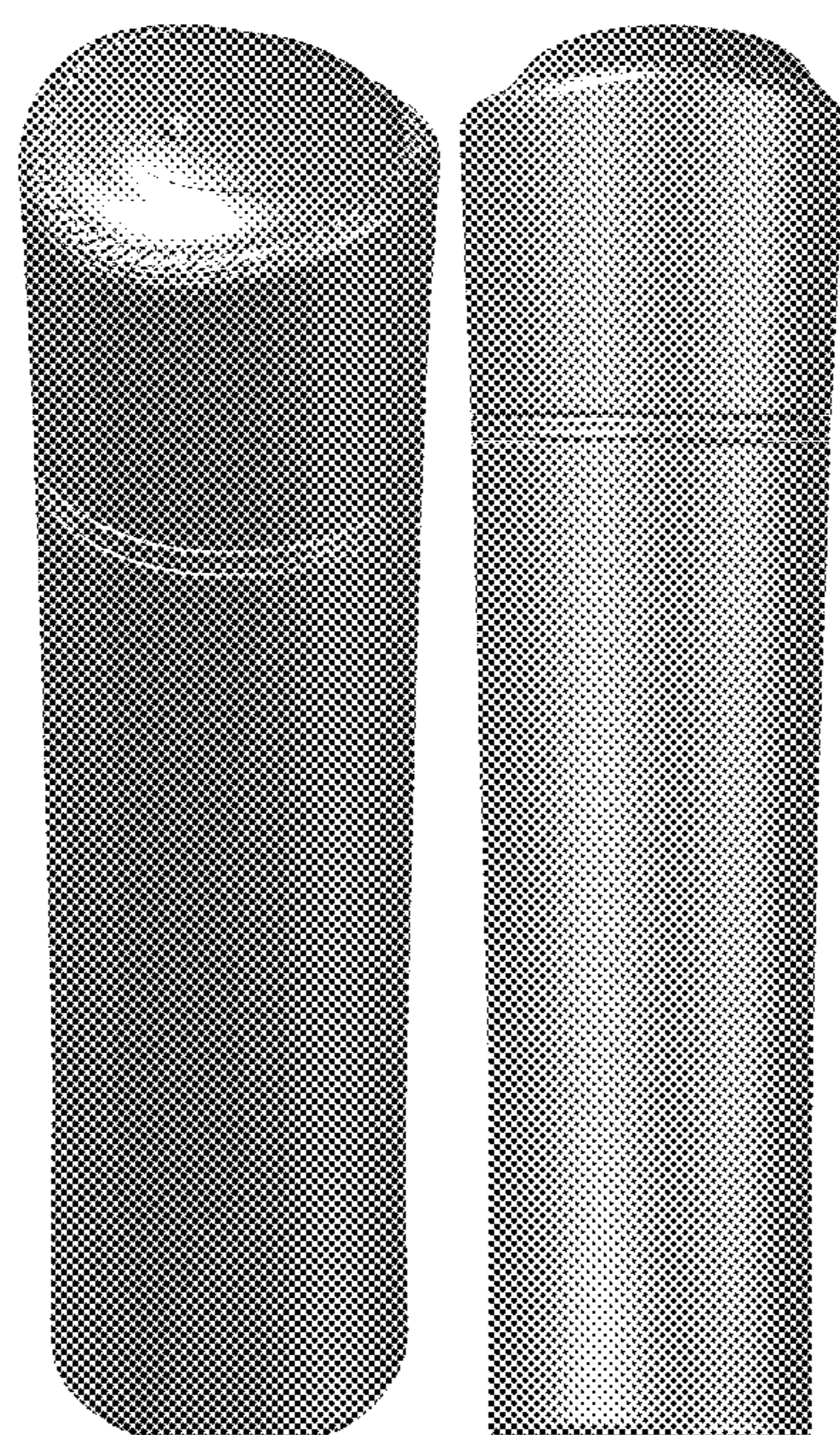

FIG. 1

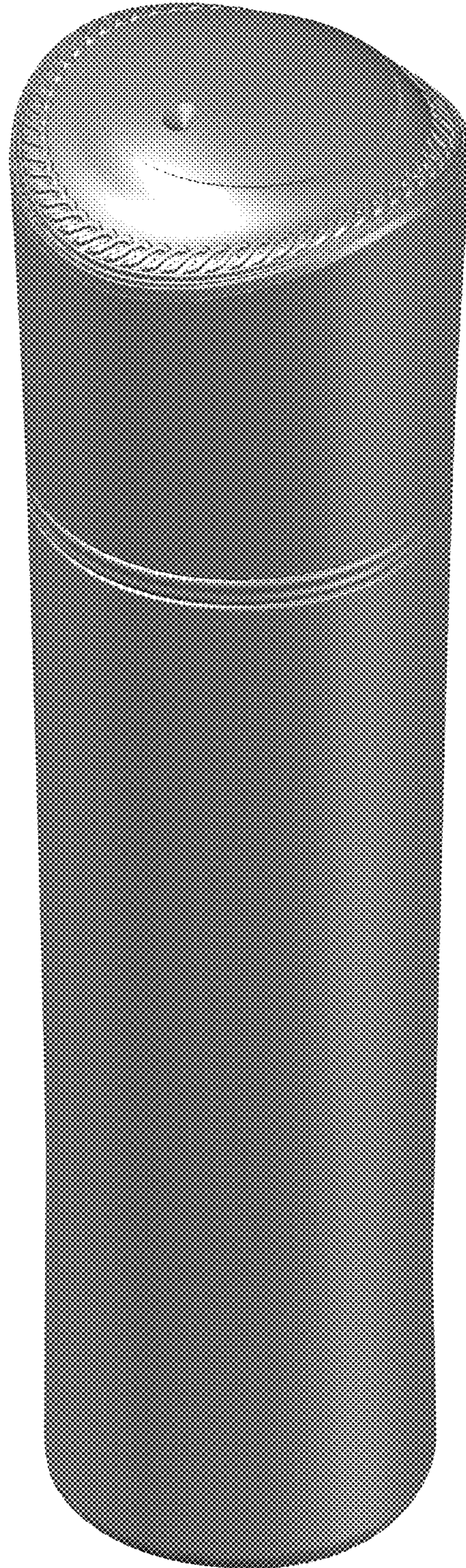

FIG.2

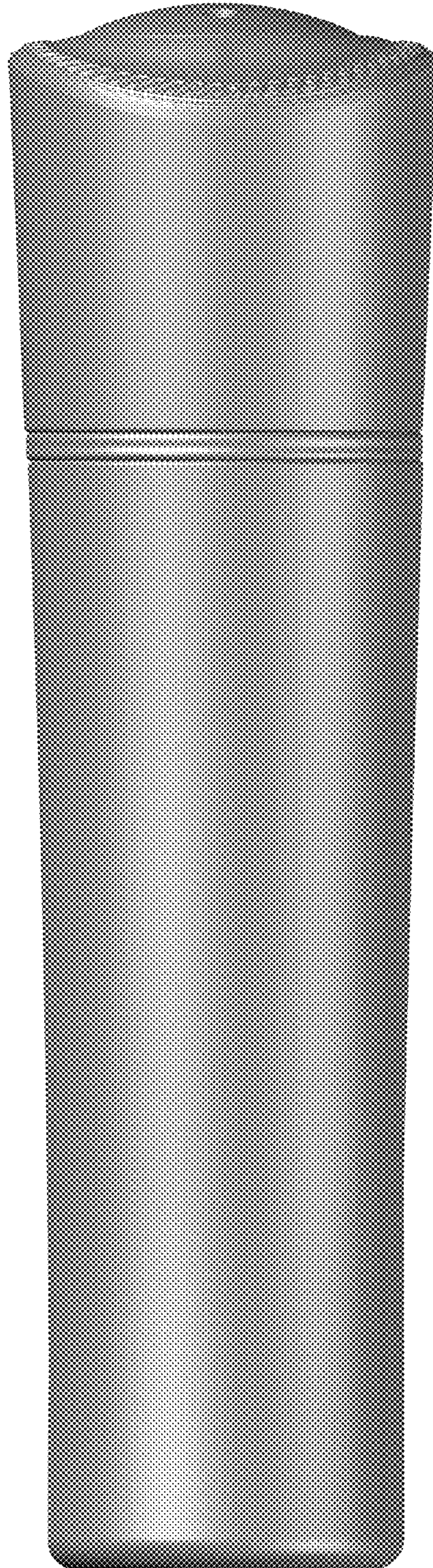

FIG.3

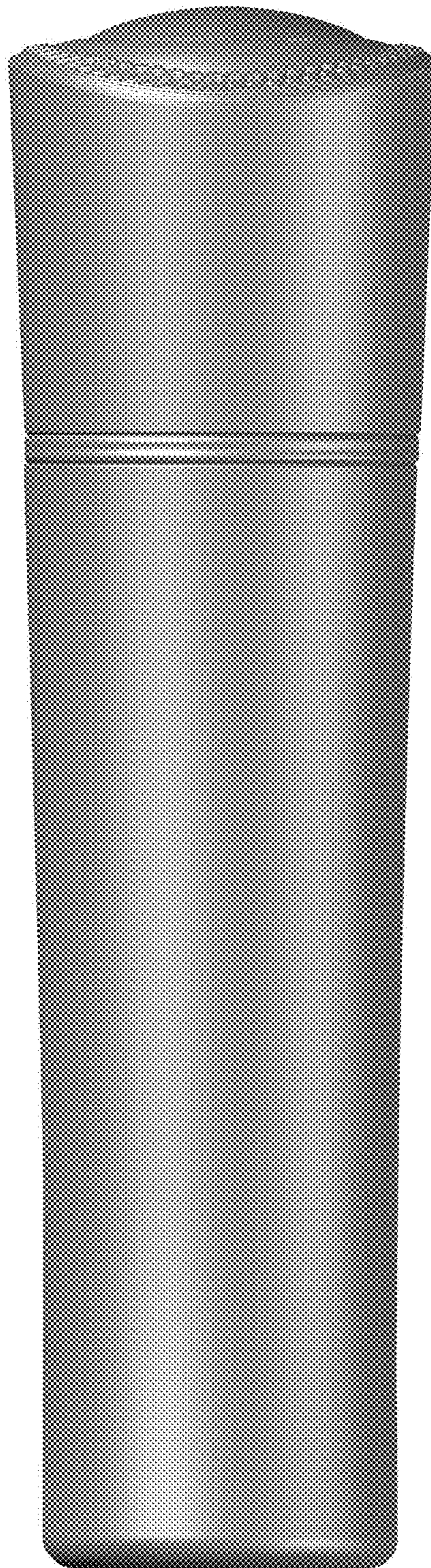

FIG.4

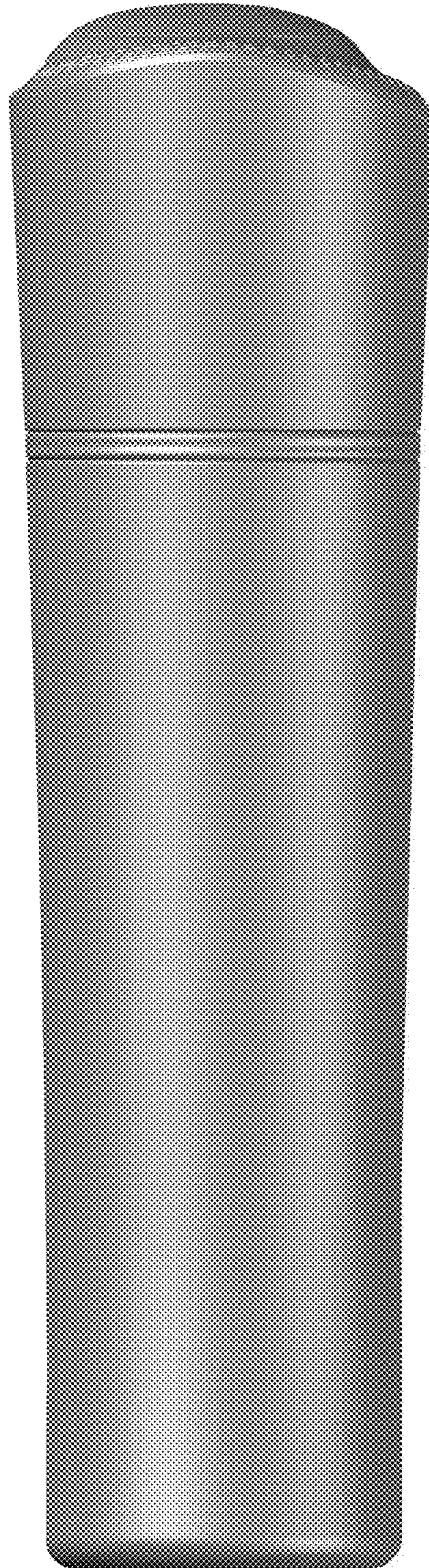

FIG.5

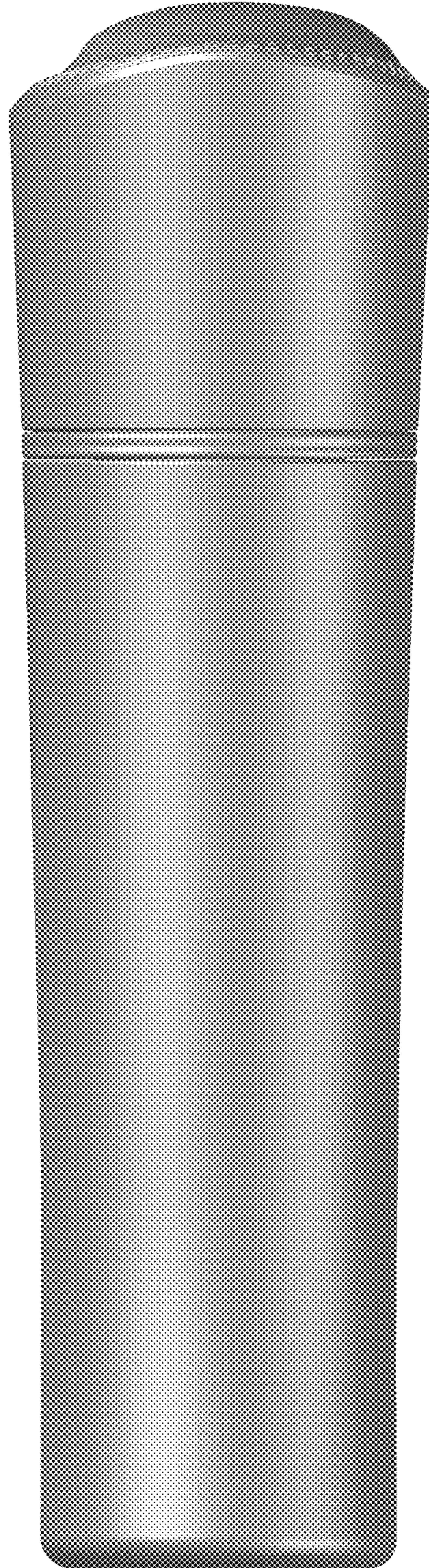

FIG.6

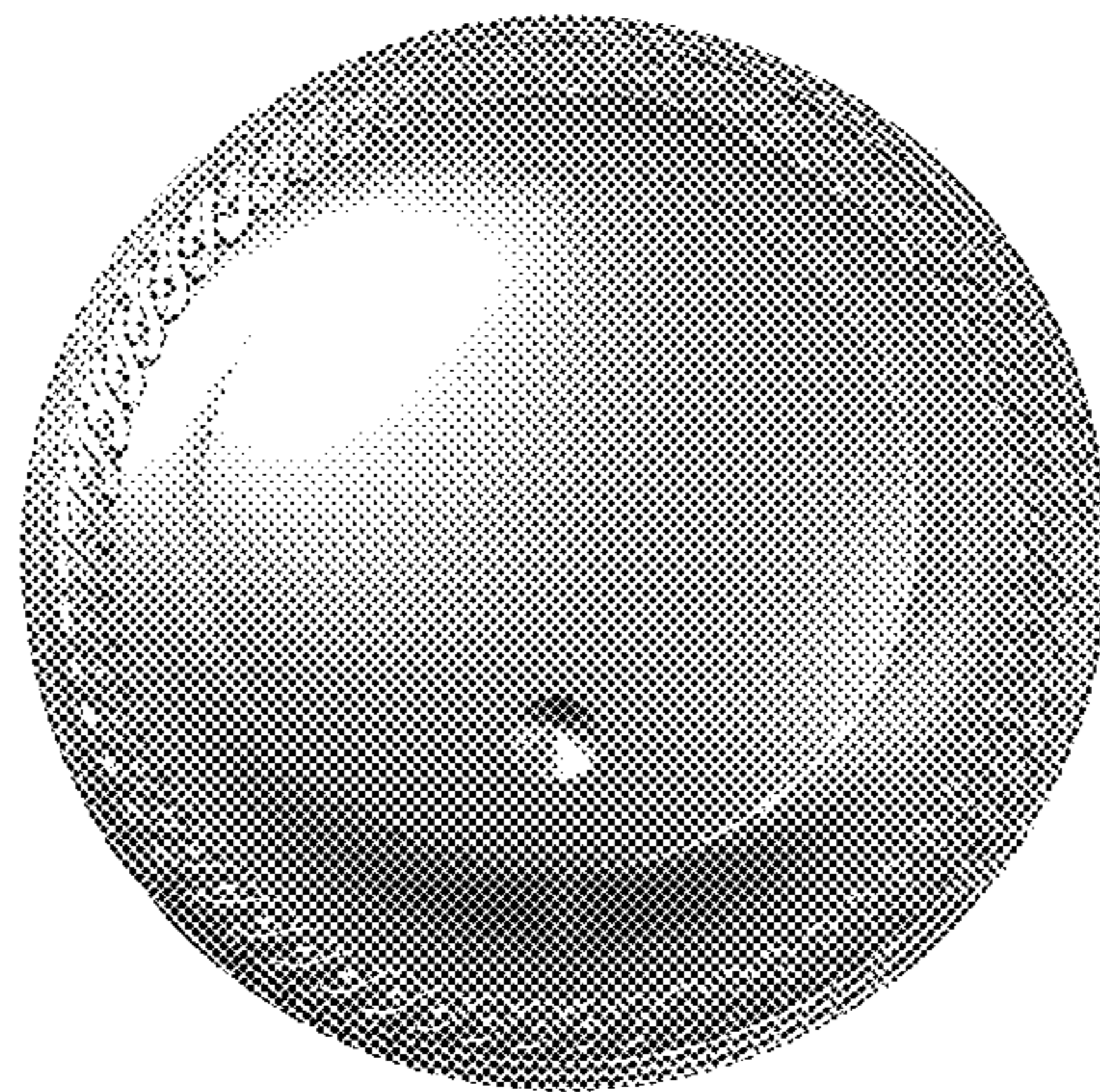

FIG.7

