



US00D909861S

(12) **United States Design Patent**
Nelson et al.

(10) **Patent No.:** **US D909,861 S**

(45) **Date of Patent:** **** Feb. 9, 2021**

(54) **GIFT AND GIFT CARD PACKAGING**

(71) Applicant: **American Greetings Corporation,**
Cleveland, OH (US)

(72) Inventors: **Gary Nelson,** Avon, OH (US); **Terry Flores,** Oberlin, OH (US)

(73) Assignee: **American Greetings Corporation,**
Cleveland, OH (US)

(**) Term: **15 Years**

(21) Appl. No.: **29/755,933**

(22) Filed: **Oct. 23, 2020**

Related U.S. Application Data

(62) Division of application No. 29/631,947, filed on Jan. 4, 2018.

(51) **LOC (13) Cl.** **09-03**

(52) **U.S. Cl.**
USPC **D9/415; D9/423**

(58) **Field of Classification Search**
USPC D9/414, 415, 416, 420, 423, 432, 433,
D9/658, 722, 737; D3/201, 203.1, 273,
D3/294, 298, 299, 300, 304, 314; D19/1,
D19/10
CPC .. B42D 15/045; B42D 15/022; B42D 15/027;
B42D 15/042; A63H 3/18
See application file for complete search history.

(56) **References Cited**

U.S. PATENT DOCUMENTS

2,314,721 A * 3/1943 Lowenstein A63J 13/00
428/13
2,417,982 A * 3/1947 Histed B42D 5/028
229/92.8

4,433,780 A * 2/1984 Ellis B42D 15/022
206/232
6,050,415 A * 4/2000 Lind B65D 73/0092
206/462
6,260,703 B1 * 7/2001 Morton B42D 15/045
206/387.1

(Continued)

Primary Examiner — Lauren R Calve

(74) *Attorney, Agent, or Firm* — Christine Flanagan

(57) **CLAIM**

The ornamental design for a gift and gift card packaging, as shown and described.

DESCRIPTION

FIG. 1 is a perspective view of the gift and gift card packaging of the present invention, with box in a closed position.

FIG. 2 is a bottom up view of the gift and gift card packaging of FIG. 1.

FIG. 3 is a top down view of the gift and gift card packaging of FIG. 1.

FIG. 4 is a right side view of the gift and gift card packaging of FIG. 1, the left side view being a mirror image thereof.

FIG. 5 is a front view of the gift and gift card packaging of FIG. 1.

FIG. 6 is a rear view of the gift and gift card packaging of FIG. 1.

FIG. 7 is a perspective view of the gift and gift card packaging of FIG. 1, with box in an open position.

FIG. 8 is a bottom up view of the gift and gift card packaging of FIG. 7.

FIG. 9 is a top down view of the gift and gift card packaging of FIG. 7.

FIG. 10 is a right side view of the gift and gift card packaging of FIG. 7, the left side view being a mirror image thereof.

FIG. 11 is a front view of the gift and gift card packaging of FIG. 7; and,

FIG. 12 is a rear view of the gift and gift card packaging of FIG. 7.

1 Claim, 6 Drawing Sheets

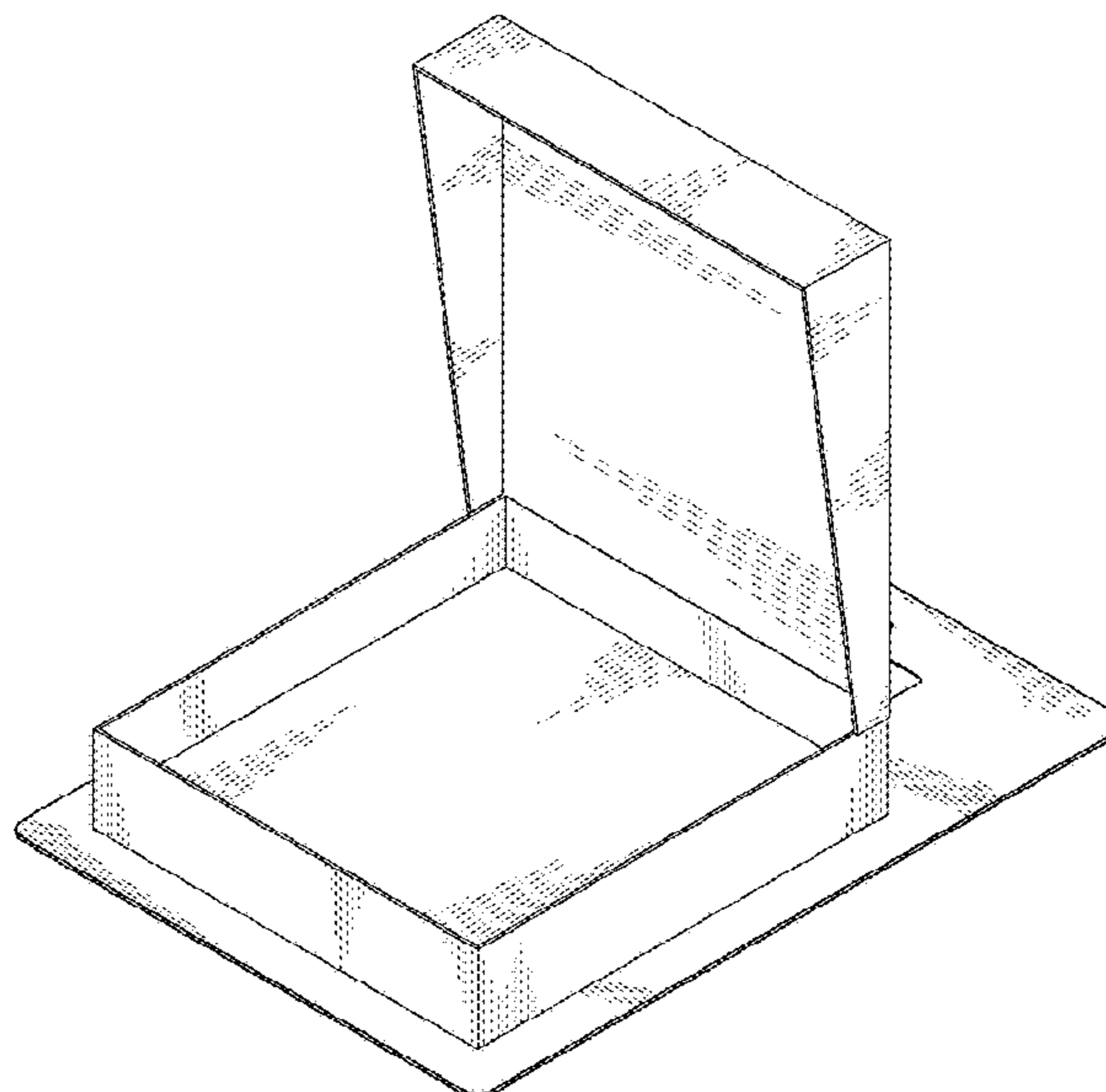
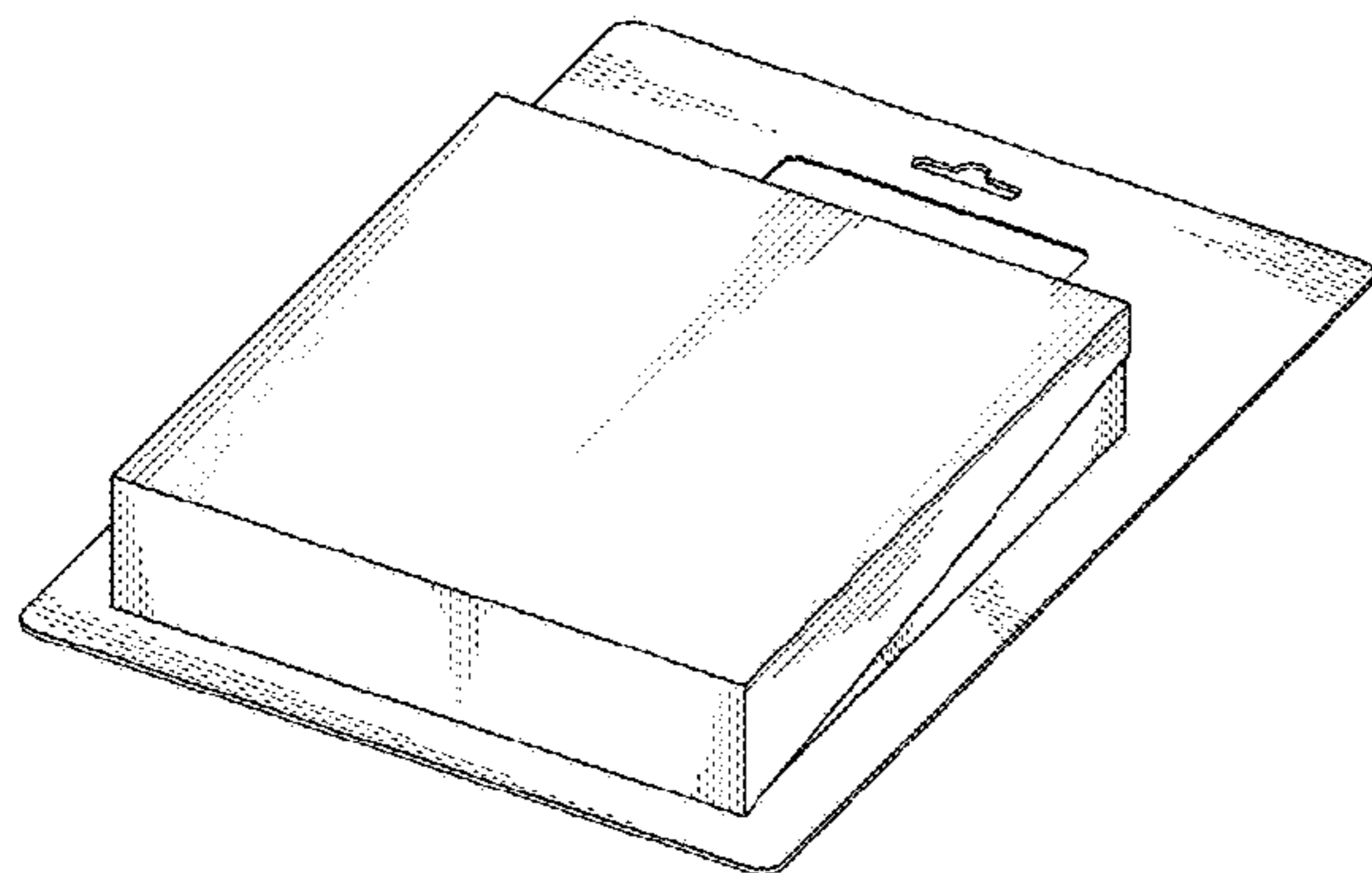

(56)

References Cited

U.S. PATENT DOCUMENTS

D461,121 S * 8/2002 DiMartino D9/415
6,957,737 B1 * 10/2005 Frederickson G06Q 20/3437
206/449
D632,955 S * 2/2011 Smith, III D9/415
D675,109 S * 1/2013 Stahl D9/732
8,448,360 B2 * 5/2013 Guo B42D 15/022
40/124.03
D687,293 S * 8/2013 Glass D9/415
D699,107 S * 2/2014 Streich D9/457
8,672,129 B2 * 3/2014 Glass B65D 5/4208
206/461
D720,399 S * 12/2014 Ehrlich D19/10
9,216,608 B1 * 12/2015 Nelson B42D 15/022
D759,162 S * 6/2016 Menzies D20/19
D797,574 S * 9/2017 Dascoli D9/732
9,907,374 B2 * 3/2018 Canaday A45C 11/182
D842,707 S * 3/2019 Nelson D9/722
D843,827 S * 3/2019 Nelson D9/415
D856,146 S * 8/2019 McKenzie D9/456
10,625,530 B2 * 4/2020 Nelson B42D 15/022
D890,605 S * 7/2020 Nelson D9/423
2002/0036152 A1 * 3/2002 Saiki B65D 5/504
206/485
2013/0036635 A1 * 2/2013 Mayer G06O 30/02
40/124.06
2014/0137445 A1 * 5/2014 Mandelbaum G09F 1/04
40/124.03
2015/0314950 A1 * 11/2015 Lopez B65D 5/422
206/232
2017/0361220 A1 * 12/2017 Mayer A63F 13/00
2018/0339540 A1 * 11/2018 Barnhardt B42D 15/027

* cited by examiner

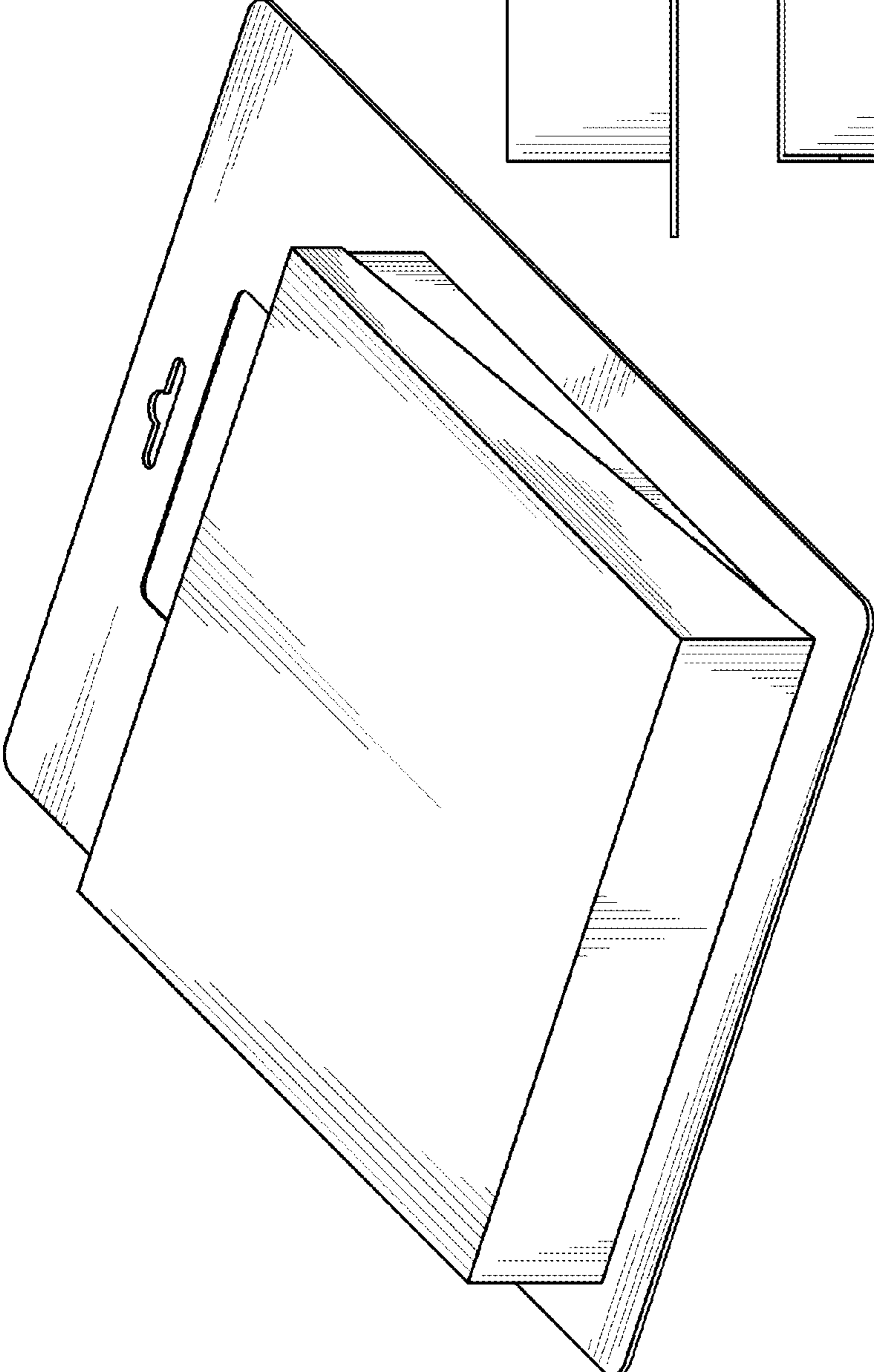

Fig. 1

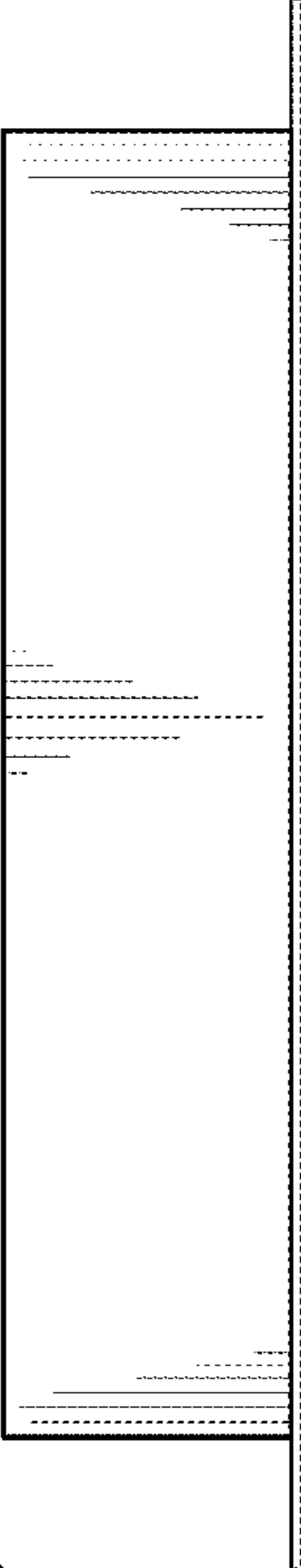

Fig. 2

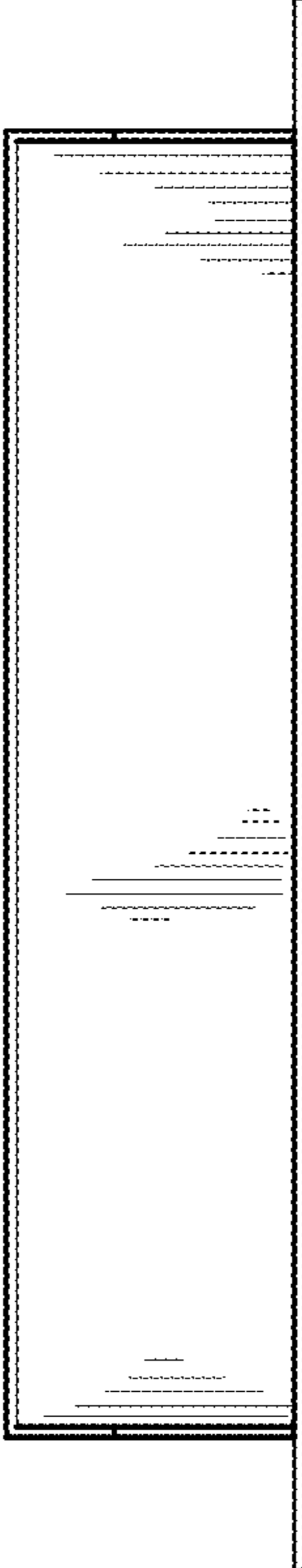

Fig. 3

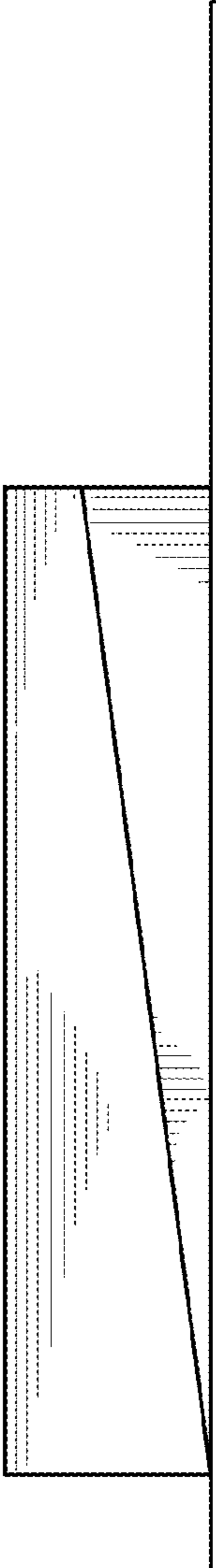

Fig. 4

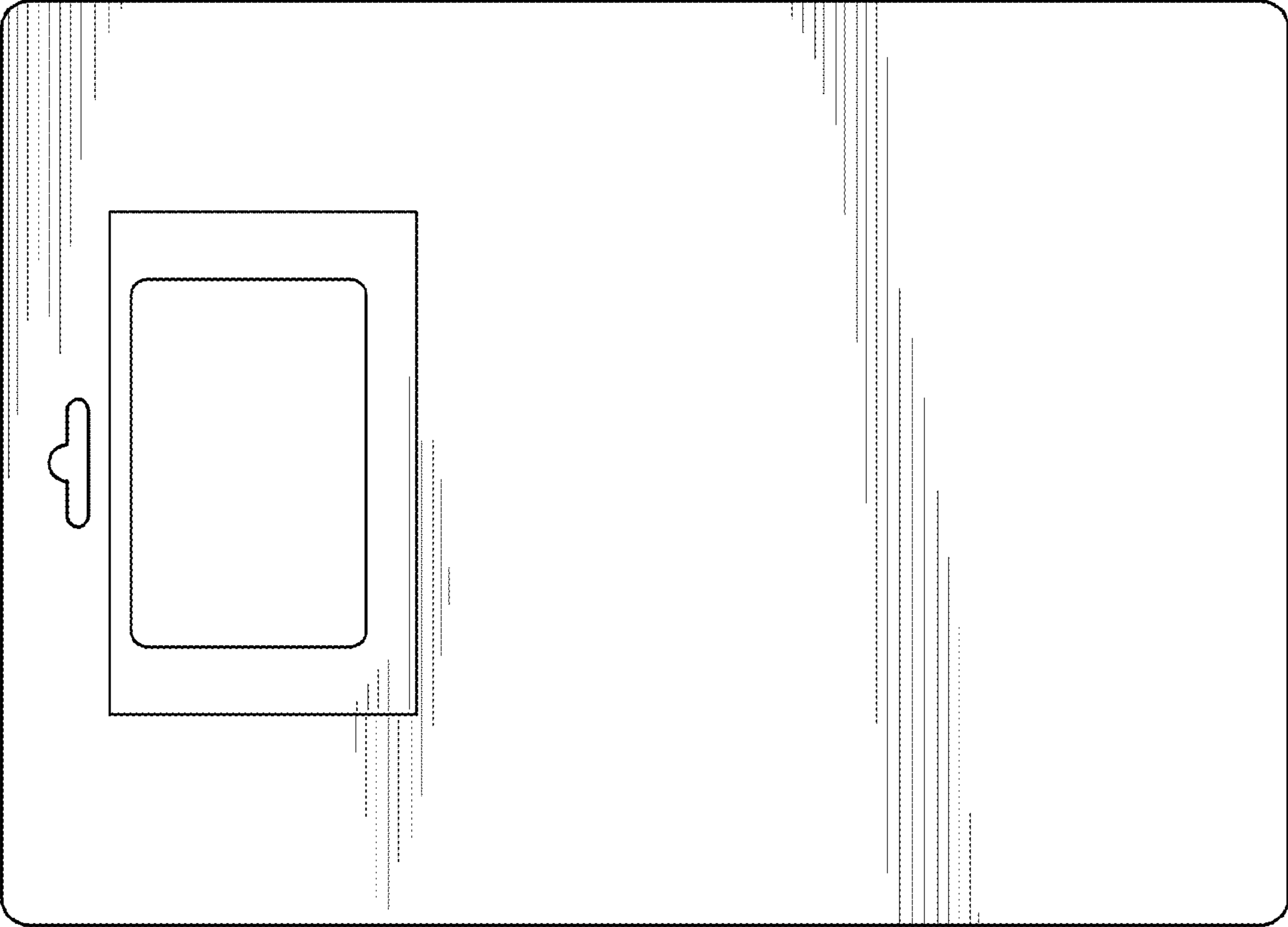

Fig. 6

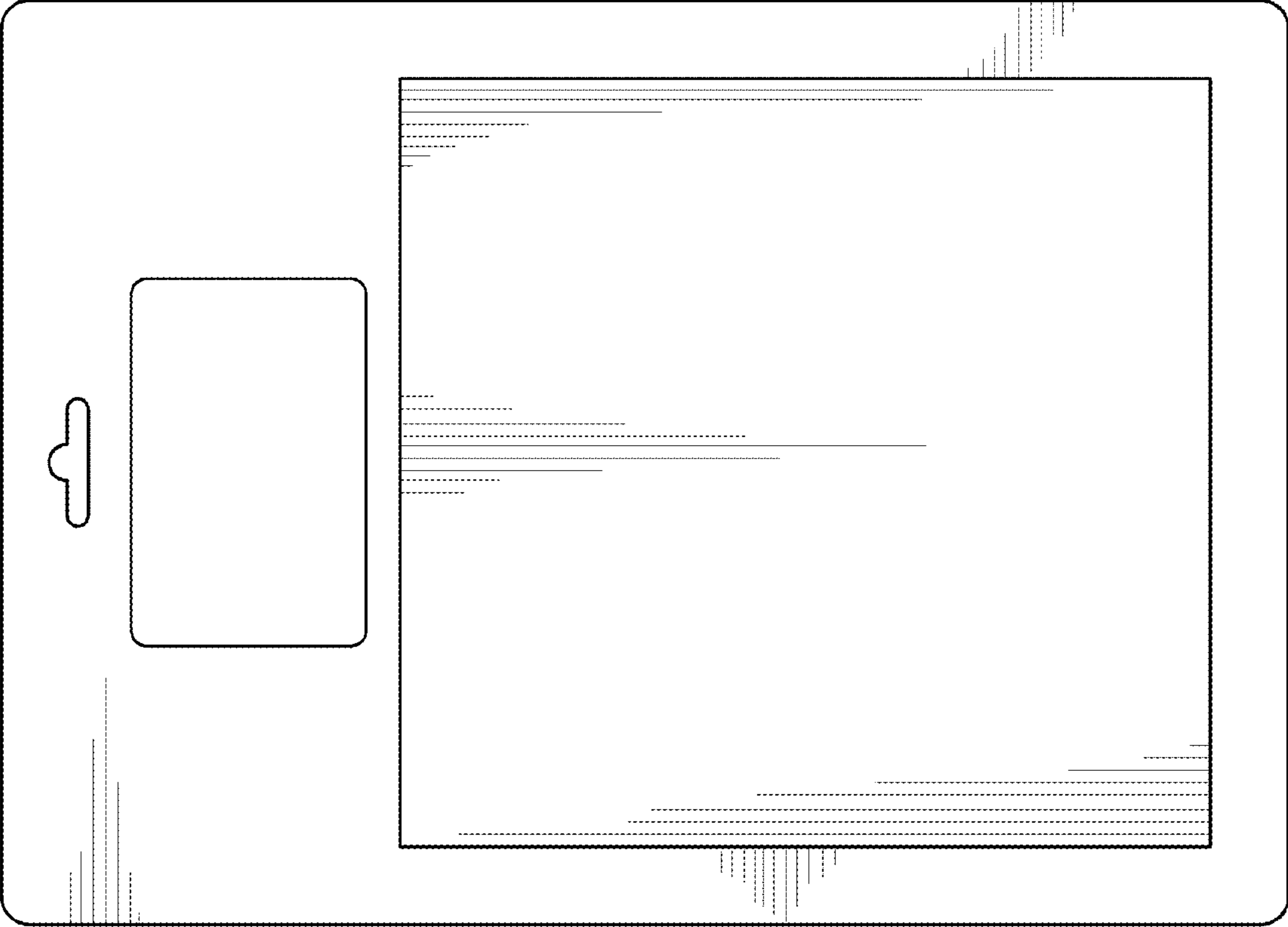

Fig. 5

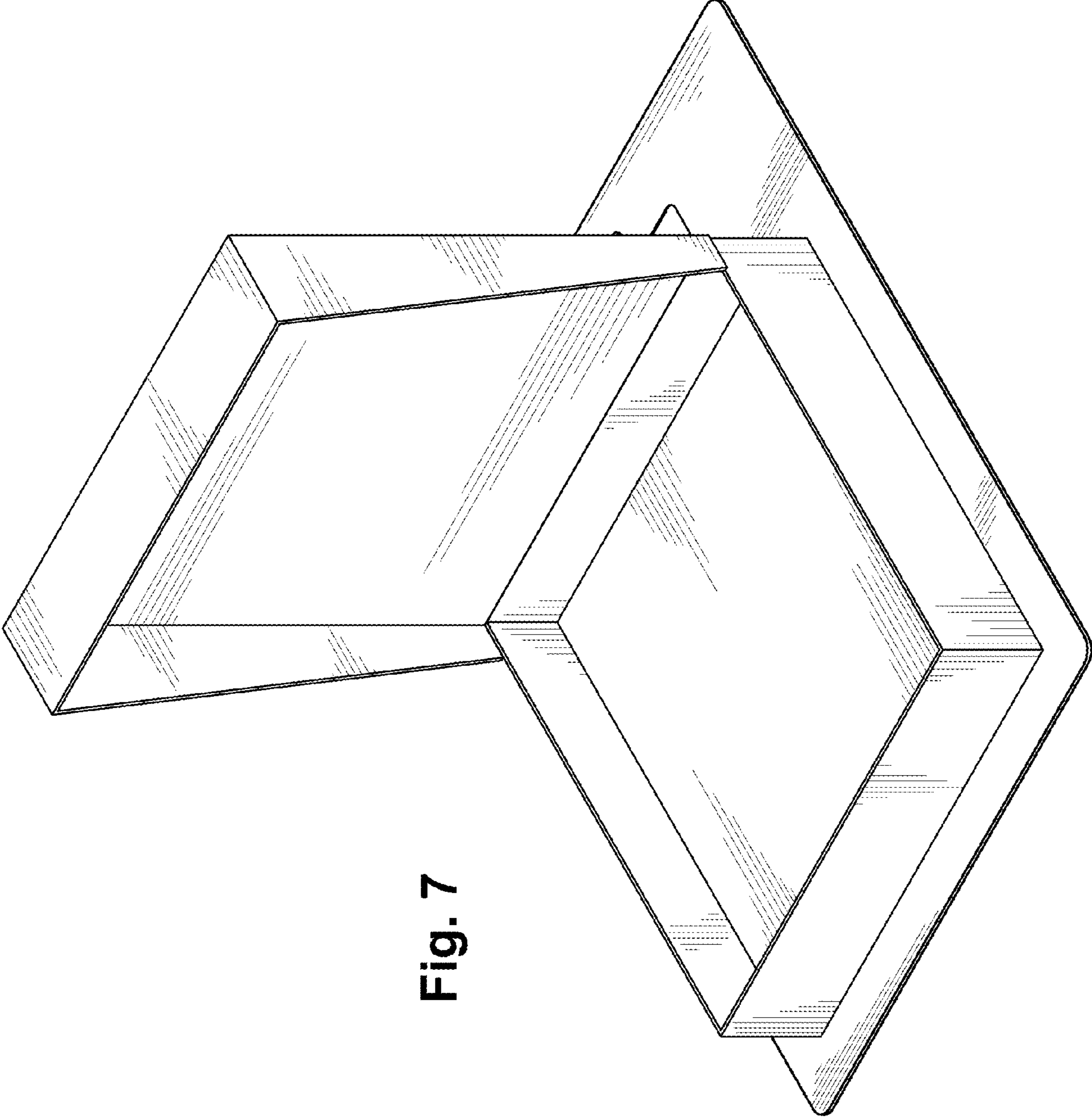

Fig. 7

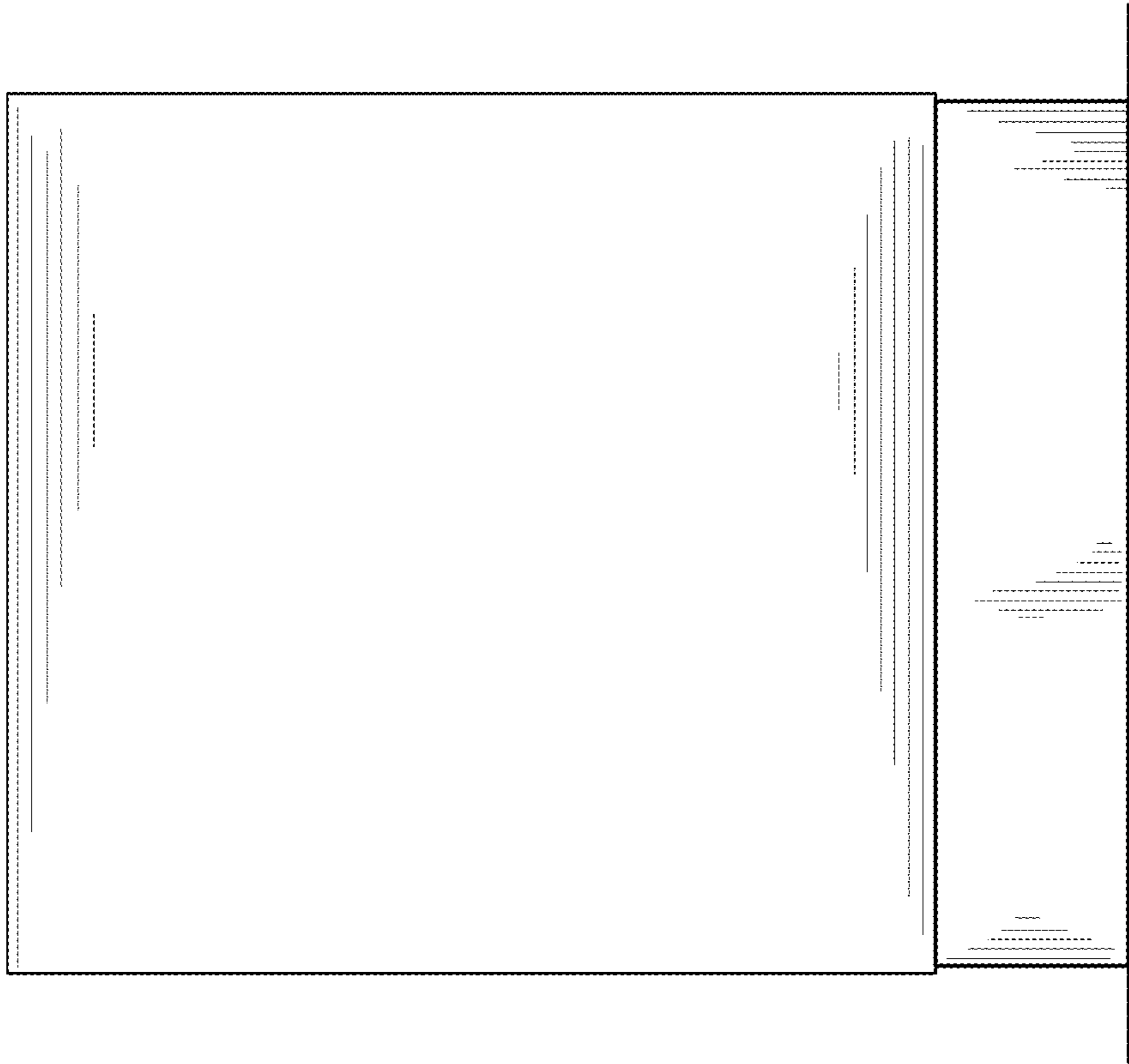

Fig. 9

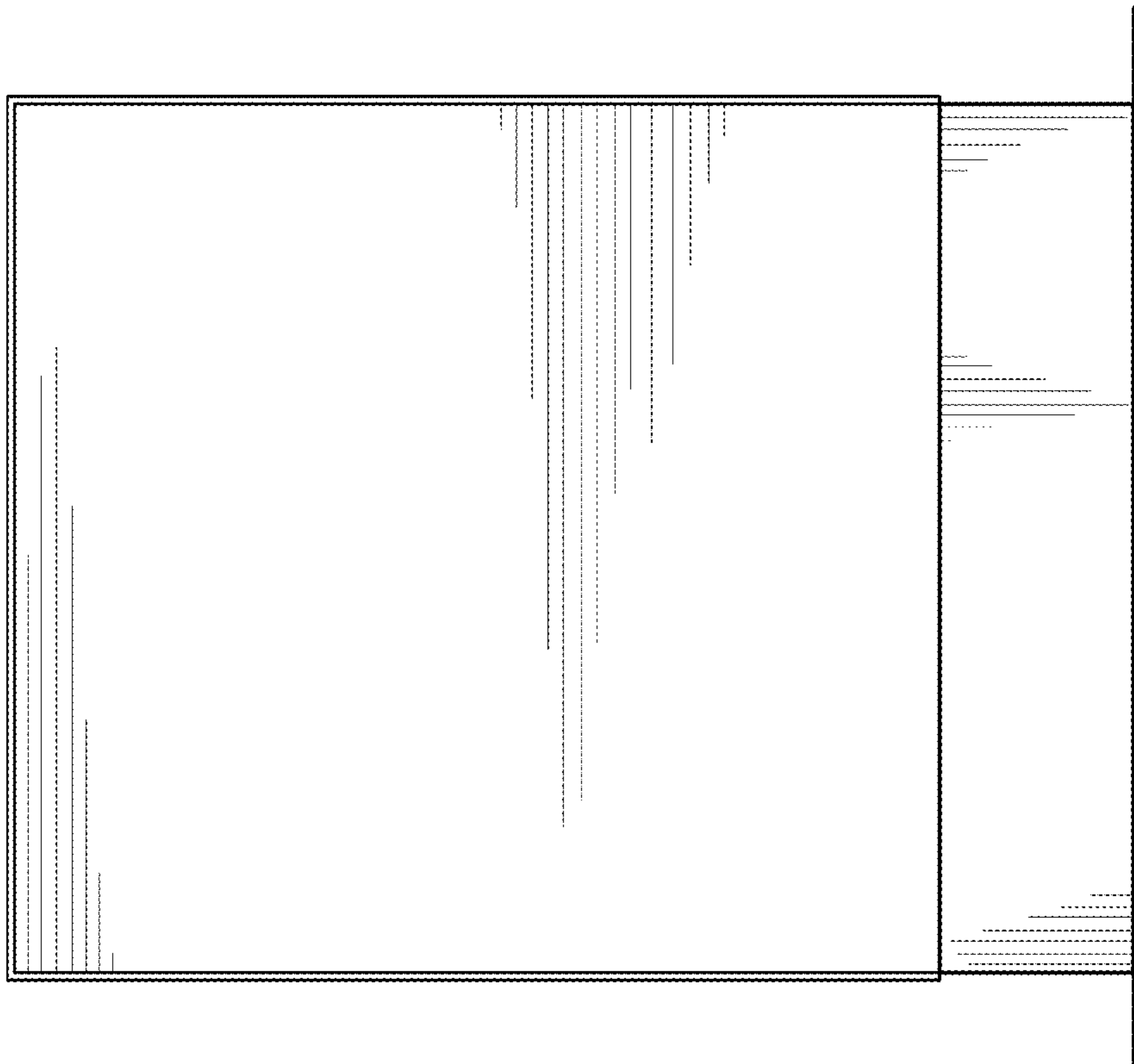

Fig. 8

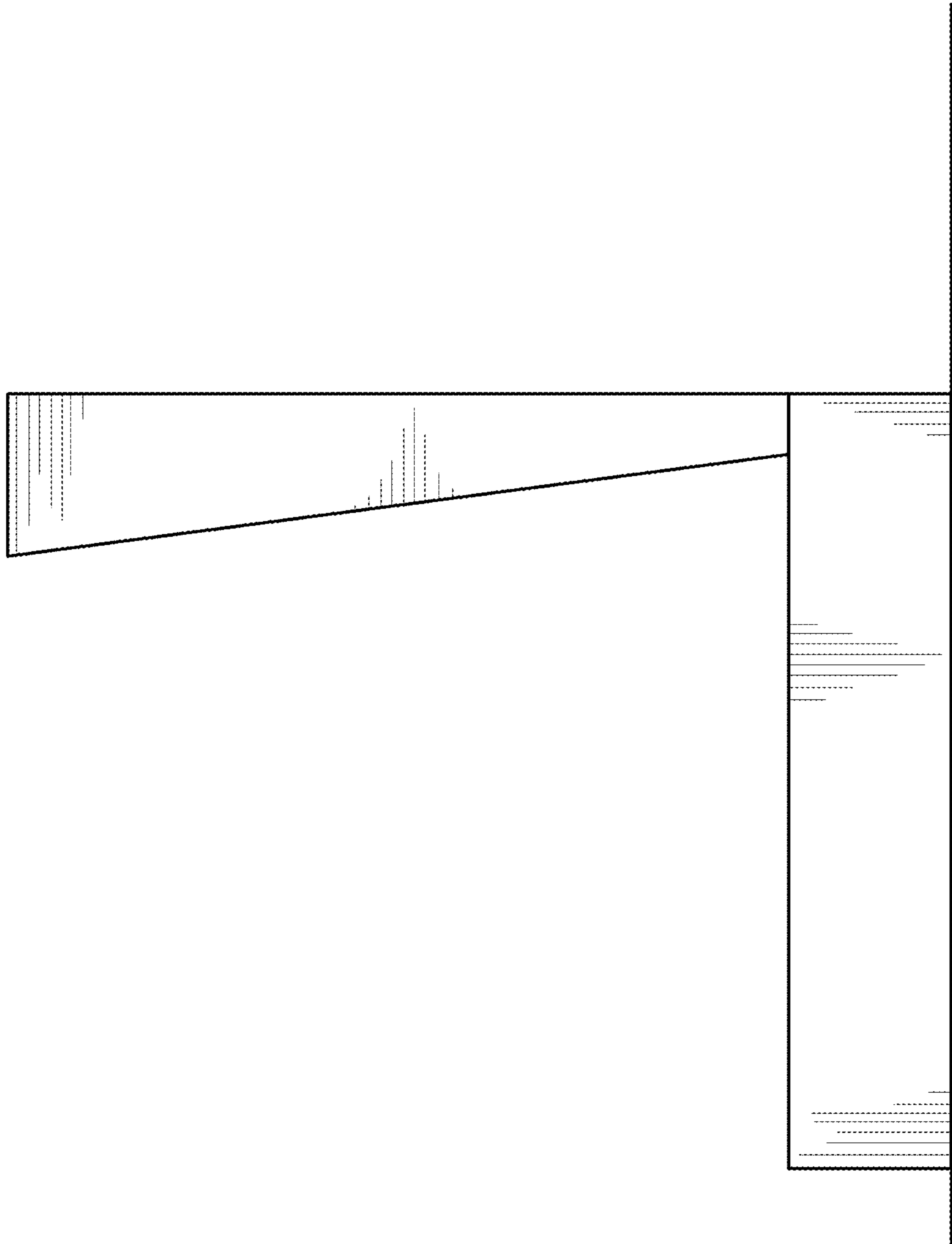

Fig. 10

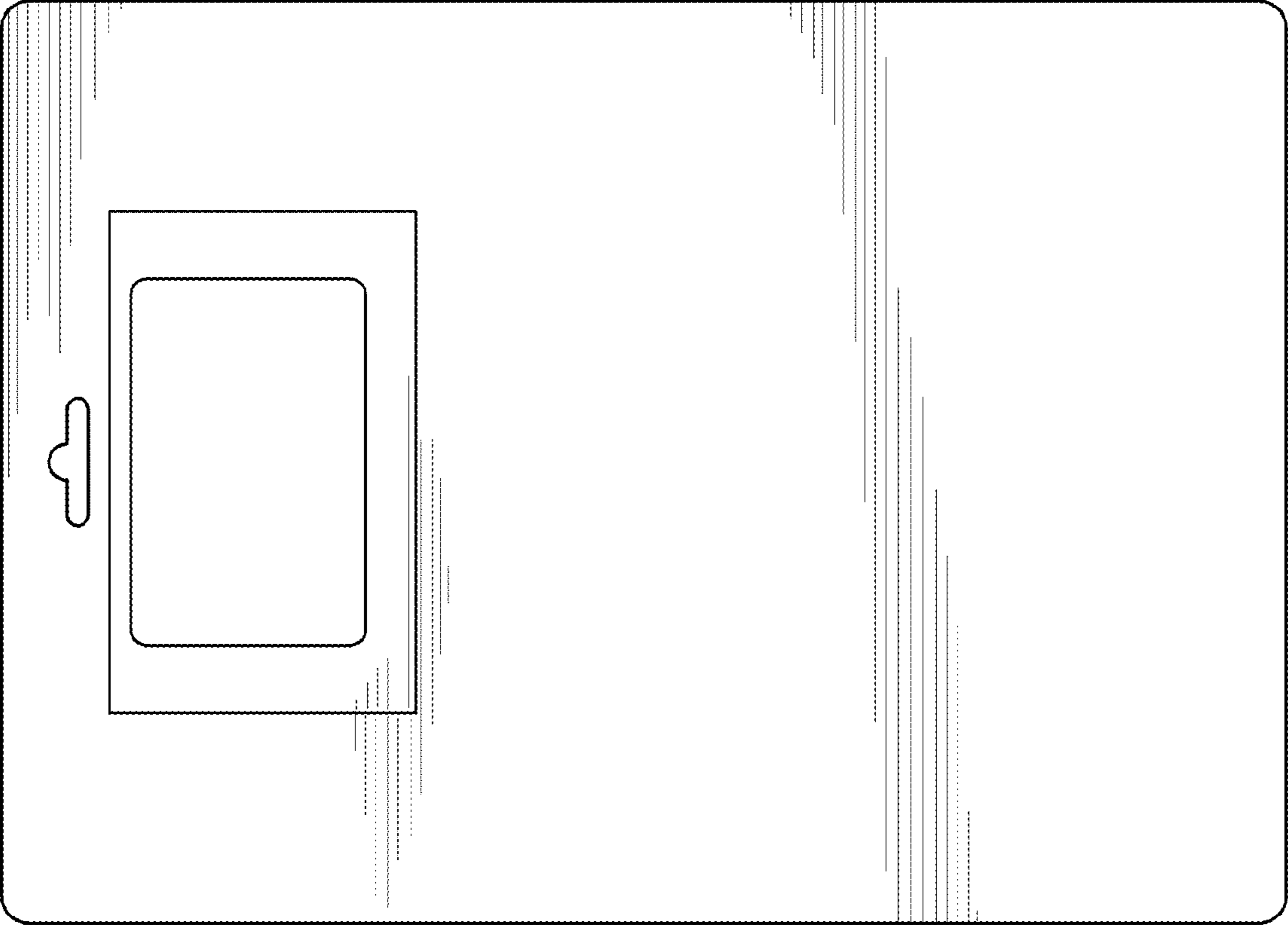

Fig. 12

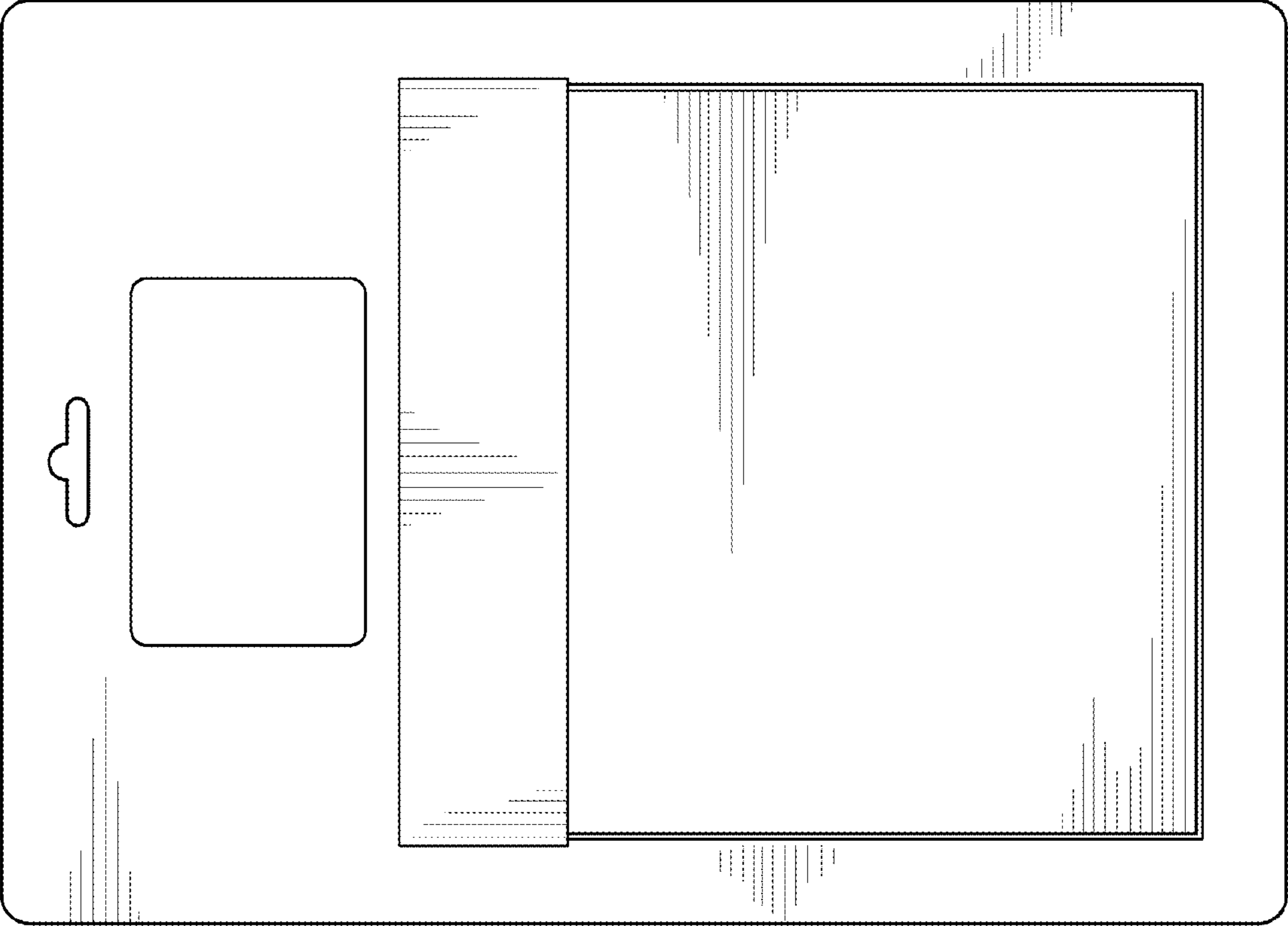

Fig. 11