



US00D909800S

(12) **United States Design Patent** (10) **Patent No.:** **US D909,800 S**
Peng (45) **Date of Patent:** **** Feb. 9, 2021**

(54) **HALL TREE** 4,054,209 A * 10/1977 Solomon A47F 7/24
211/208
(71) Applicant: **EASEPAL ENTERPRISES, LIMITED**, Hong Kong (CN) D247,592 S * 3/1978 Eisen D6/673
D248,915 S * 8/1978 Brandenfels D6/672
D311,099 S * 10/1990 Yau Kee D6/300
(72) Inventor: **Leo Peng**, Xiamen (CN) D382,513 S * 8/1997 Bozzone D11/131
5,685,440 A * 11/1997 Mason A47F 5/13
211/189

(73) Assignee: **EASEPAL ENTERPRISES, LIMITED**, Hong Kong (CN)

(Continued)

(**) Term: **15 Years**

OTHER PUBLICATIONS

(21) Appl. No.: **29/743,283**

Leopard Hall Tree, https://www.amazon.com/Leopard-Entryway-Storage-Organizer-Furniture/dp/B086V1SHM1/ref=sr_1_1?dchild=1&keywords=Leopard+Large+Hall+Trees+with+Bench+and+Coat+Racks+with+Grid+Wall&qid=1605715712&sr=8-1 (Year: 2020).*

(22) Filed: **Jul. 21, 2020**

(Continued)

Related U.S. Application Data

(63) Continuation-in-part of application No. 29/731,260, filed on Apr. 14, 2020.

Primary Examiner — Steven J Czyz

(51) **LOC (13) Cl.** **20-02**

(74) *Attorney, Agent, or Firm* — Bayramoglu Law Offices LLC

(52) **U.S. Cl.**
USPC **D6/672**

(57) **CLAIM**

(58) **Field of Classification Search**
USPC D6/672, 675, 675.1, 675.2, 675.3, 675.4, D6/675.5, 681, 681.1, 681.2, 681.3
CPC .. A47F 1/00; A47F 3/00; A47F 3/0439; A47F 3/06; A47F 5/0018; A47F 5/0081; A47B 96/00; A47B 96/02; A47B 47/00; A47B 47/021

The ornamental design for a hall tree, as shown and described.

See application file for complete search history.

DESCRIPTION

(56) **References Cited**

U.S. PATENT DOCUMENTS

2,798,618 A * 7/1957 Singer A47G 25/0664
211/204
3,561,609 A * 2/1971 Doherty F16B 7/00
211/206
3,565,020 A * 2/1971 Schier A47B 96/028
108/152
3,620,377 A * 11/1971 Holtz A47G 25/0664
211/206
D237,231 S * 10/1975 Wells et al. D6/672

FIG. 1 is a front perspective view of a hall tree showing my new design;
FIG. 2 is a front elevational view thereof;
FIG. 3 is a rear elevational view thereof;
FIG. 4 is a right side elevational view thereof;
FIG. 5 is a top plan view thereof;
FIG. 6 is a bottom plan view thereof;
FIG. 7 is a rear perspective view thereof; and,
FIG. 8 is a partial enlarged view of the indicated area "8" in FIG. 1.

A left side elevational view thereof is omitted since the left side elevational view thereof is a mirror image of the right side elevational view thereof.

1 Claim, 8 Drawing Sheets

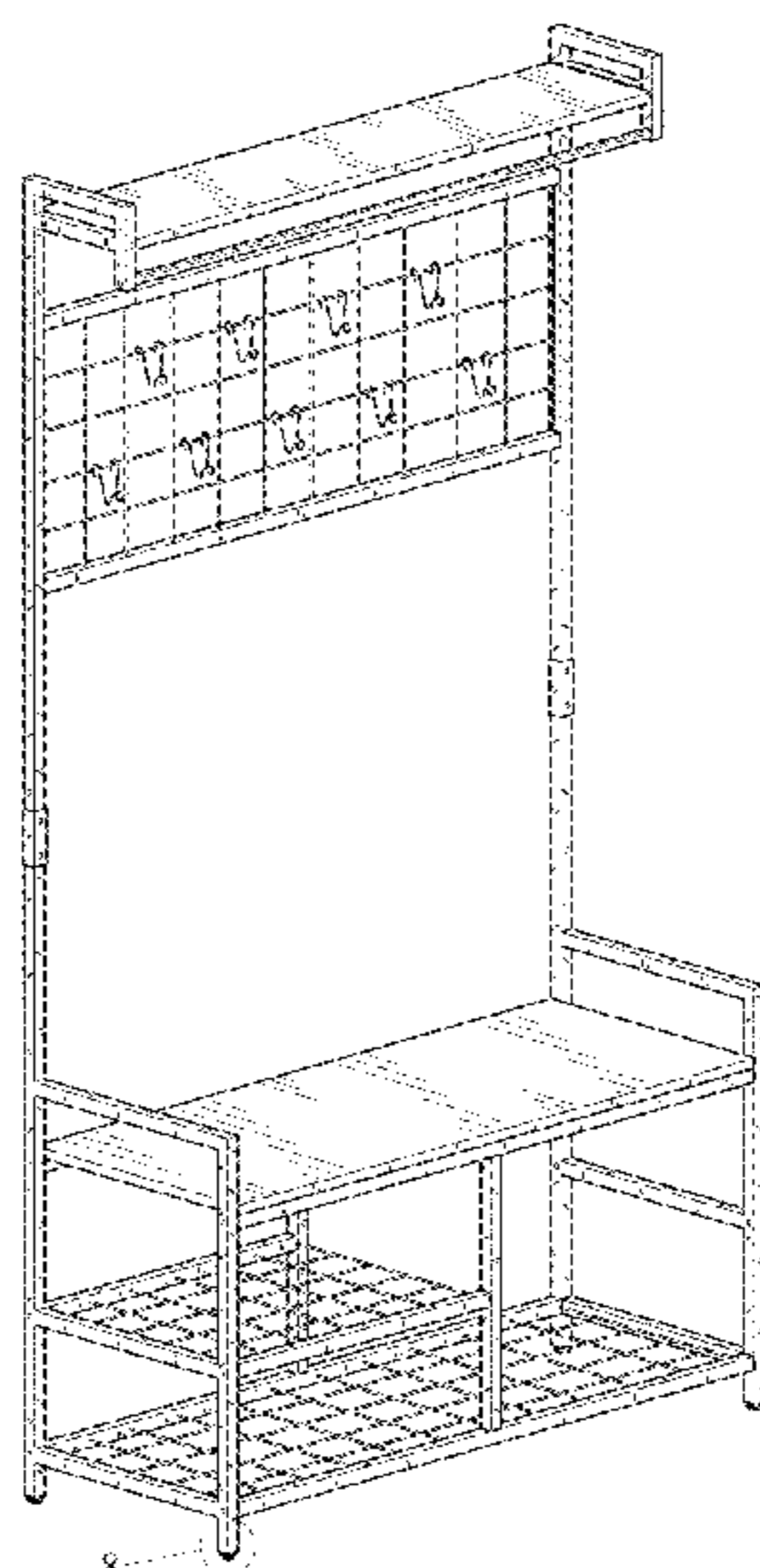

(56)

References Cited

U.S. PATENT DOCUMENTS

D391,421 S * 3/1998 Steelman D6/675.1
 D415,365 S * 10/1999 Nicklas D6/684
 D451,304 S * 12/2001 Felsenthal D6/678.4
 6,401,948 B1 * 6/2002 Huang A47F 5/137
 211/206
 6,644,484 B1 * 11/2003 Sardis A47B 43/00
 211/189
 D491,742 S * 6/2004 Harwanko D6/681.1
 D498,962 S * 11/2004 Moon D6/552
 D512,585 S * 12/2005 Rozenboom D6/675.1
 D546,013 S * 7/2007 Pong D32/58
 D582,188 S * 12/2008 Martin D6/552
 D591,533 S * 5/2009 Karsson D6/675.3
 D613,965 S * 4/2010 Tertel D6/675.5
 D617,576 S * 6/2010 Lin D6/681.1
 D624,200 S * 9/2010 Kieffer D25/65
 7,946,434 B1 * 5/2011 Greenspon A47G 25/0685
 211/85.3
 D643,232 S * 8/2011 Wagner D6/675.3
 D716,080 S * 10/2014 Bell D6/675.1
 8,936,166 B2 * 1/2015 Hornsby A47F 5/10
 211/85.3
 D736,548 S * 8/2015 Hornsby D6/681.1
 D749,879 S * 2/2016 Wall D6/680.3
 D750,401 S * 3/2016 Ruiz D6/681
 D753,940 S * 4/2016 Ruiz D6/681
 9,648,949 B1 * 5/2017 Penaflo A47B 81/00
 D790,892 S * 7/2017 Chung D6/681
 D808,200 S * 1/2018 Davis D6/675.1
 D808,203 S * 1/2018 Davis D6/675.3
 D809,835 S * 2/2018 Greenspon D6/681
 D817,039 S * 5/2018 Adolph D6/657
 D819,374 S * 6/2018 Kuehn D6/681.2

D827,342 S * 9/2018 Stukenberg D6/681
 D829,473 S * 10/2018 Mical D6/681
 10,264,878 B1 * 4/2019 Liu A47B 88/40
 D853,762 S * 7/2019 Tucker D6/672
 10,337,136 B1 * 7/2019 Fallah A47B 61/02
 D860,689 S * 9/2019 Davis D6/672
 D864,625 S * 10/2019 Rockwell D6/675
 D864,627 S * 10/2019 Rockwell D6/675
 D871,116 S * 12/2019 Li D6/675.1
 D874,191 S * 2/2020 Qi D6/664
 D883,719 S * 5/2020 Li D6/675.1
 D885,806 S * 6/2020 Rockwell D6/675
 D887,188 S * 6/2020 Felsenthal D6/681.2
 10,689,793 B2 * 6/2020 Glass A47B 61/003
 D889,171 S * 7/2020 Cao D6/681.2
 D898,492 S * 10/2020 Edgerton D6/684
 2007/0163974 A1 * 7/2007 Lai A47G 25/0664
 211/85.3
 2007/0272642 A1 * 11/2007 Baptiste A47B 43/00
 211/201
 2008/0029473 A1 * 2/2008 Hu A47G 25/0664
 211/206
 2015/0008201 A1 * 1/2015 Qiang D06F 57/06
 211/85.3
 2018/0160801 A1 * 6/2018 Felsenthal A47B 47/00

OTHER PUBLICATIONS

Puppykitty Hall Tree, https://www.amazon.com/puppykitty-Entryway-ShelfWood-Furniture-Garments/dp/B08HY7R8FG/ref=sr_1_2?dchild=1&keywords=puppykitty+modern+style+coat+rack&qid=1605716483&sr=8-2 (Year: 2020).*
 Jed Hall Tree, <https://www.wayfair.com/furniture/pdp/mistana-jed-hall-tree-w003426949.html> (Year: 2020).*

* cited by examiner

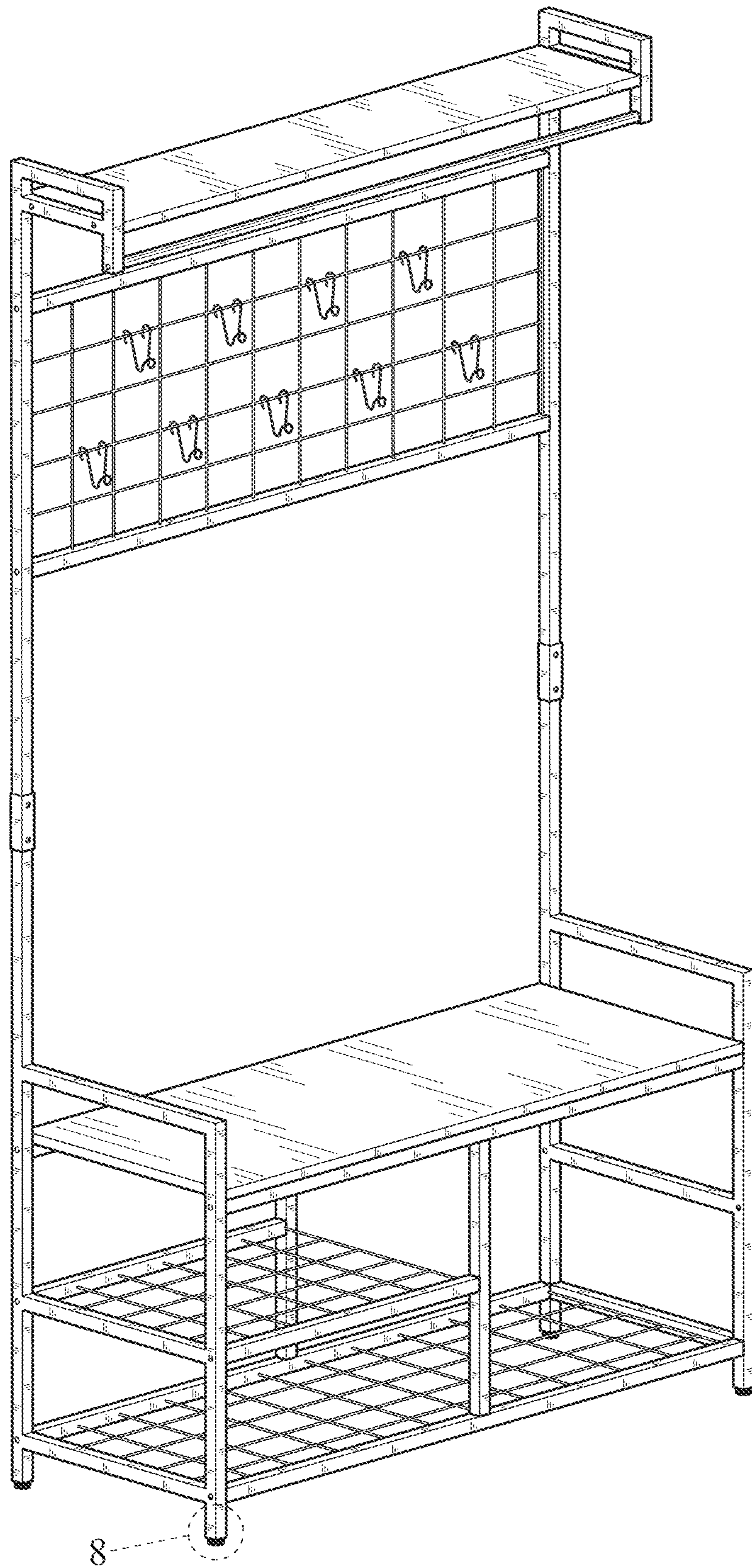

Fig. 1

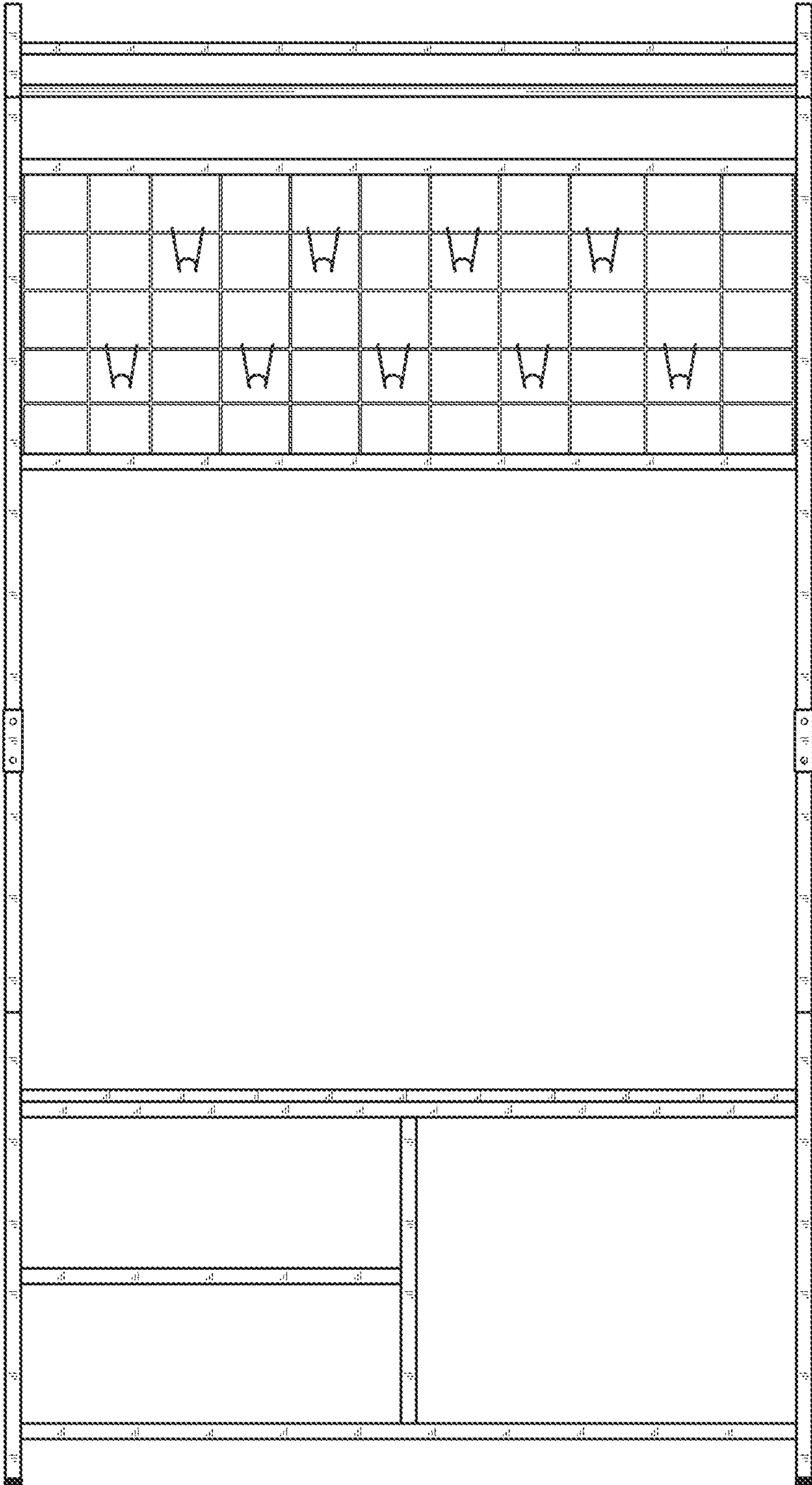

Fig. 2

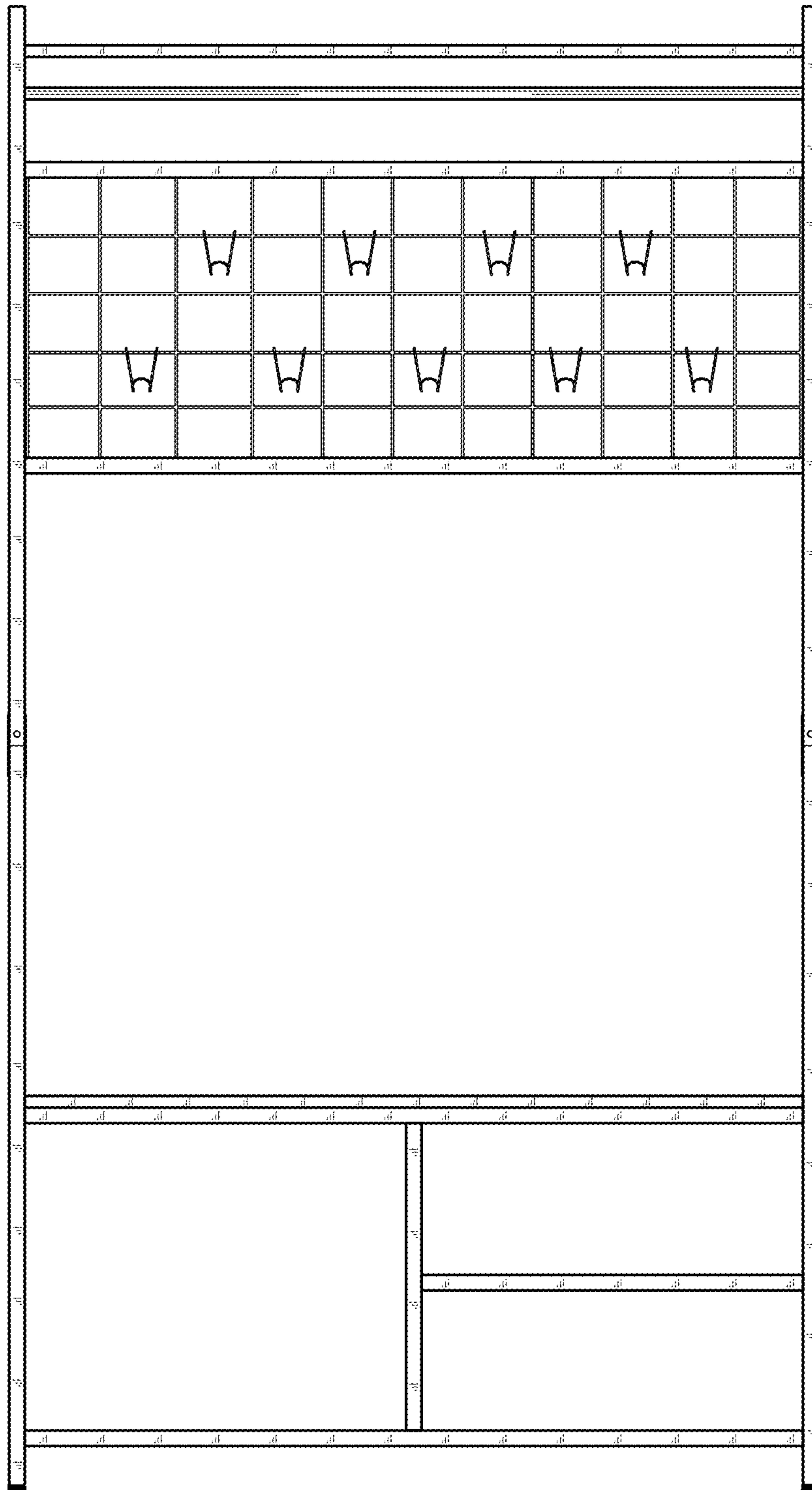

Fig. 3

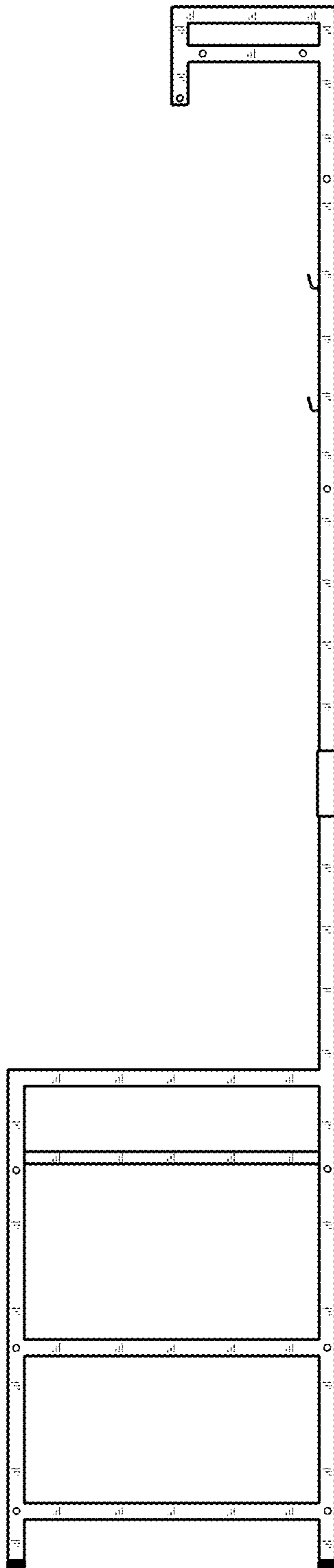

Fig. 4

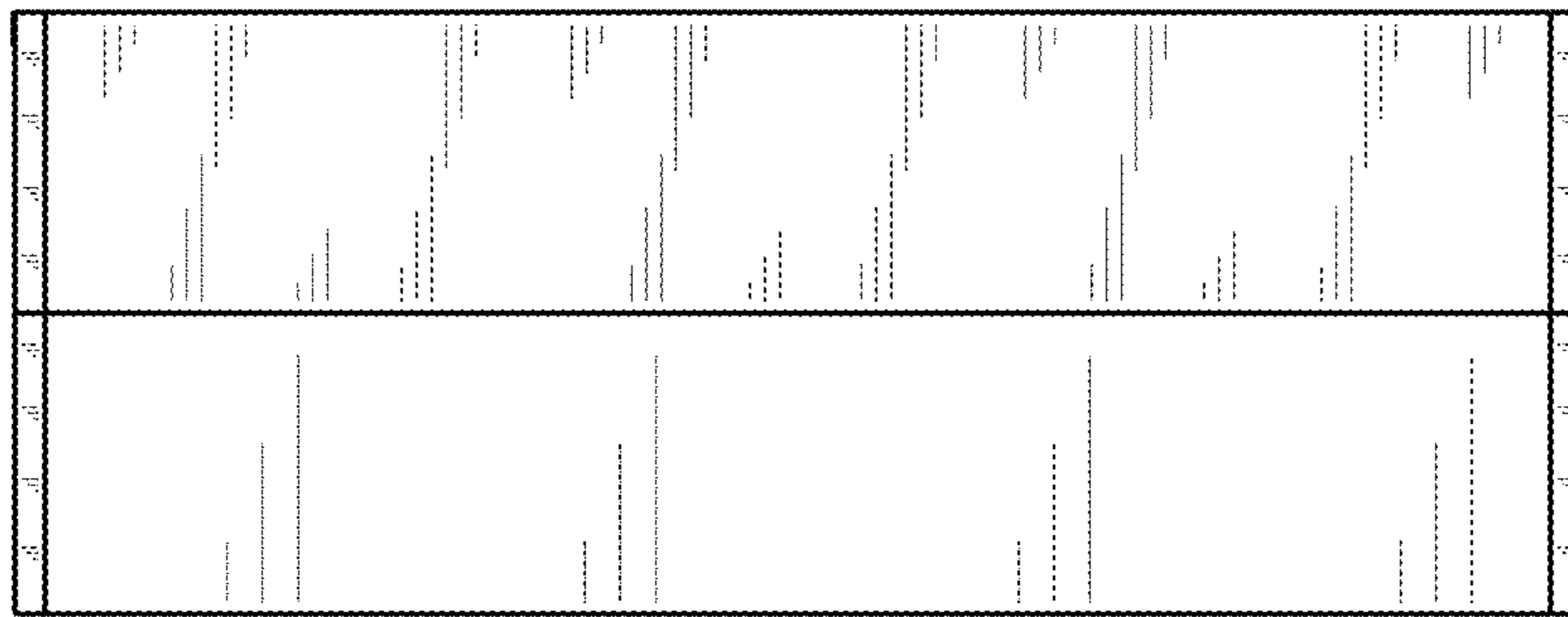

Fig. 5

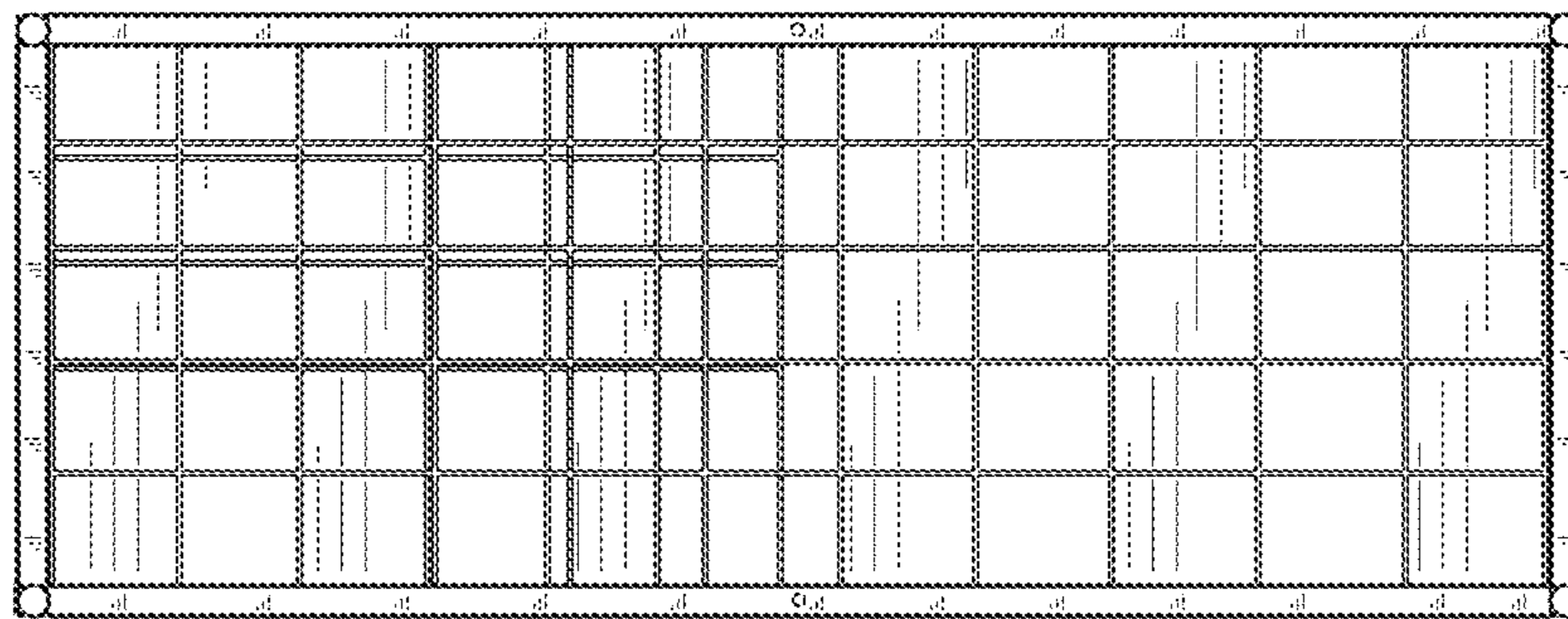

Fig. 6

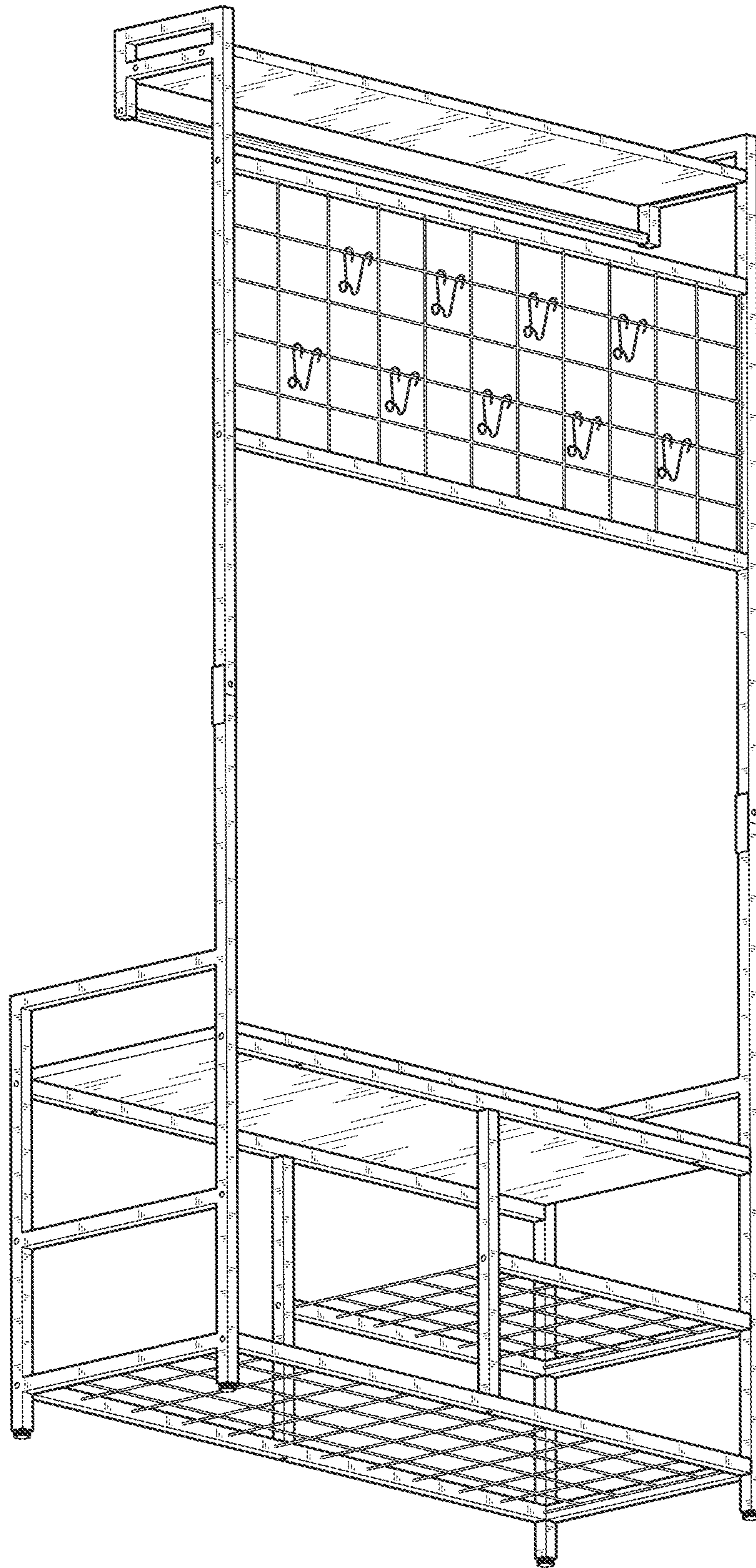

Fig. 7

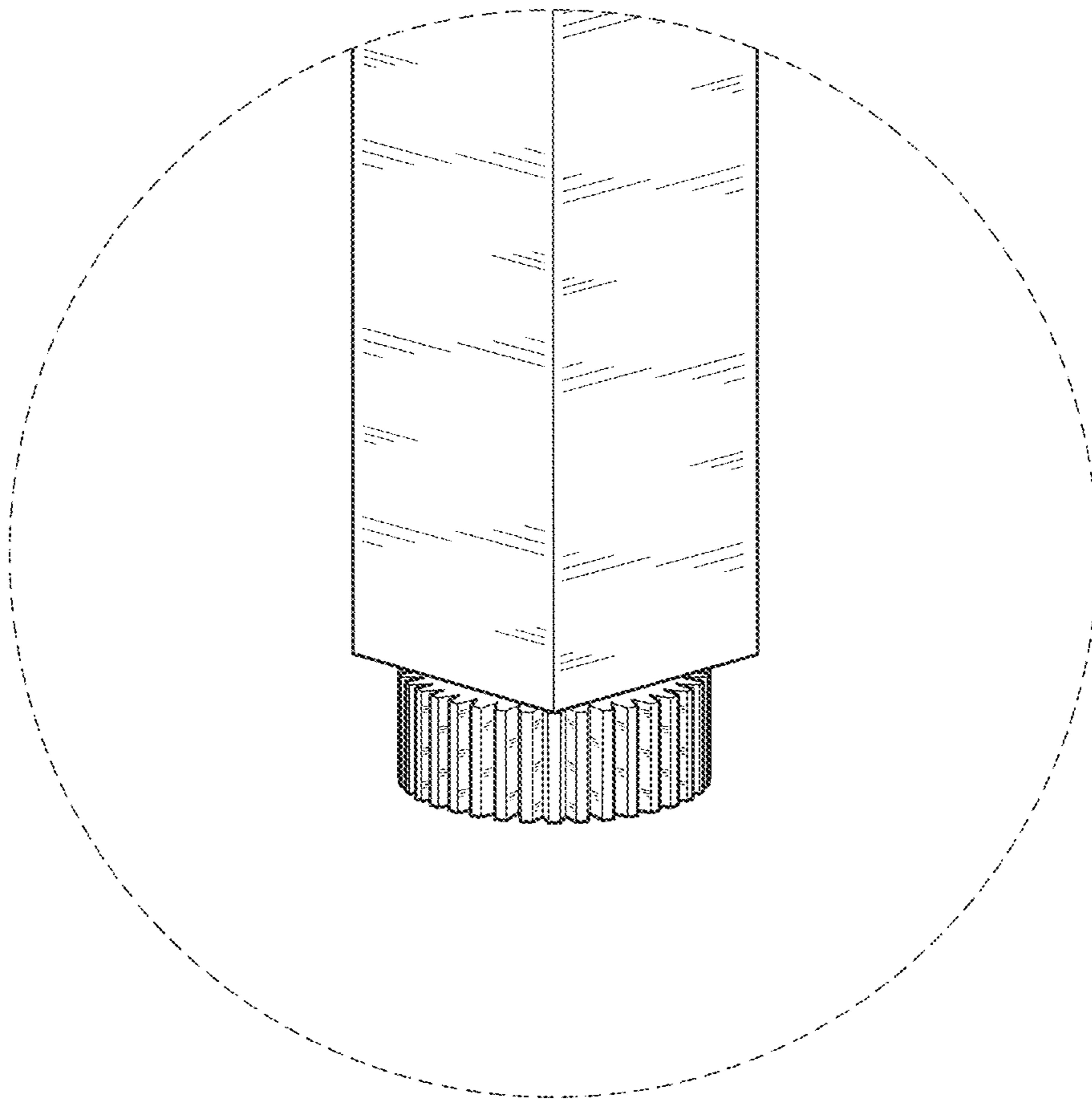

Fig. 8