



US00D909745S

(12) **United States Design Patent**
Dastmalchi

(10) **Patent No.:** **US D909,745 S**

(45) **Date of Patent:** **** Feb. 9, 2021**

(54) **FACIAL BRUSH CASE**

(71) Applicant: **Dastmalchi, LLC**, Newport Beach, CA
(US)

(72) Inventor: **Arash Dastmalchi**, Newport Beach, CA
(US)

(73) Assignee: **Dastmalchi, LLC**, Newport Beach, CA
(US)

(**) Term: **15 Years**

(21) Appl. No.: **29/686,983**

(22) Filed: **Apr. 9, 2019**

(51) **LOC (13) Cl.** **03-03**

(52) **U.S. Cl.**
USPC **D3/205**

(58) **Field of Classification Search**
USPC D3/205, 206
CPC A45C 11/00; A45C 11/008; A45C 11/26;
A45C 2011/007; A45C 9/00; A45D 44/18
See application file for complete search history.

(56) **References Cited**

U.S. PATENT DOCUMENTS

| | | | | |
|--------------|---------|------------|-------|-----------|
| D367,558 S * | 3/1996 | Lai | | D3/281 |
| D370,557 S * | 6/1996 | Ferris | | D3/201 |
| D484,305 S * | 12/2003 | Eldon, III | | D3/205 |
| D778,503 S * | 2/2017 | Teller | | D28/85 |
| D811,723 S * | 3/2018 | Chen | | D3/206 |
| D829,120 S * | 9/2018 | Mitchell | | D10/104.1 |
| D839,586 S * | 2/2019 | Li | | D3/205 |

D853,113 S * 7/2019 Wang D3/276

* cited by examiner

Primary Examiner — Charles D Hanson

(74) *Attorney, Agent, or Firm* — Avyno Law P.C.

(57) **CLAIM**

I claim the ornamental design for a facial brush case, as shown and described.

DESCRIPTION

FIG. 1 is a top front perspective view of a facial brush case. FIG. 2 is a top view of the facial brush case of FIG. 1. FIG. 3 is a bottom view of the facial brush case of FIG. 1. FIG. 4 is a front view of the facial brush case of FIG. 1. FIG. 5 is a rear view of the facial brush case of FIG. 1. FIG. 6 is a side view of the right side of the facial brush case of FIG. 1. FIG. 7 is a side view of the left side of the facial brush case of FIG. 1. FIG. 8 is an exploded rear perspective view of the facial brush case of FIG. 1. FIG. 9 is a top view of the lower portion of the facial brush case of FIG. 1. FIG. 10 is a rear view of the view lower portion of the facial brush case of FIG. 1. FIG. 11 is a front view of the lower portion of the facial brush case of FIG. 1. FIG. 12 is a side view of the right side of the lower portion of the facial brush case of FIG. 1; and, FIG. 13 is a side view of the left side of the lower portion of the facial brush case of FIG. 1. In the drawings, the broken lines depict portions of the facial brush case that form no part of the claimed design.

1 Claim, 7 Drawing Sheets

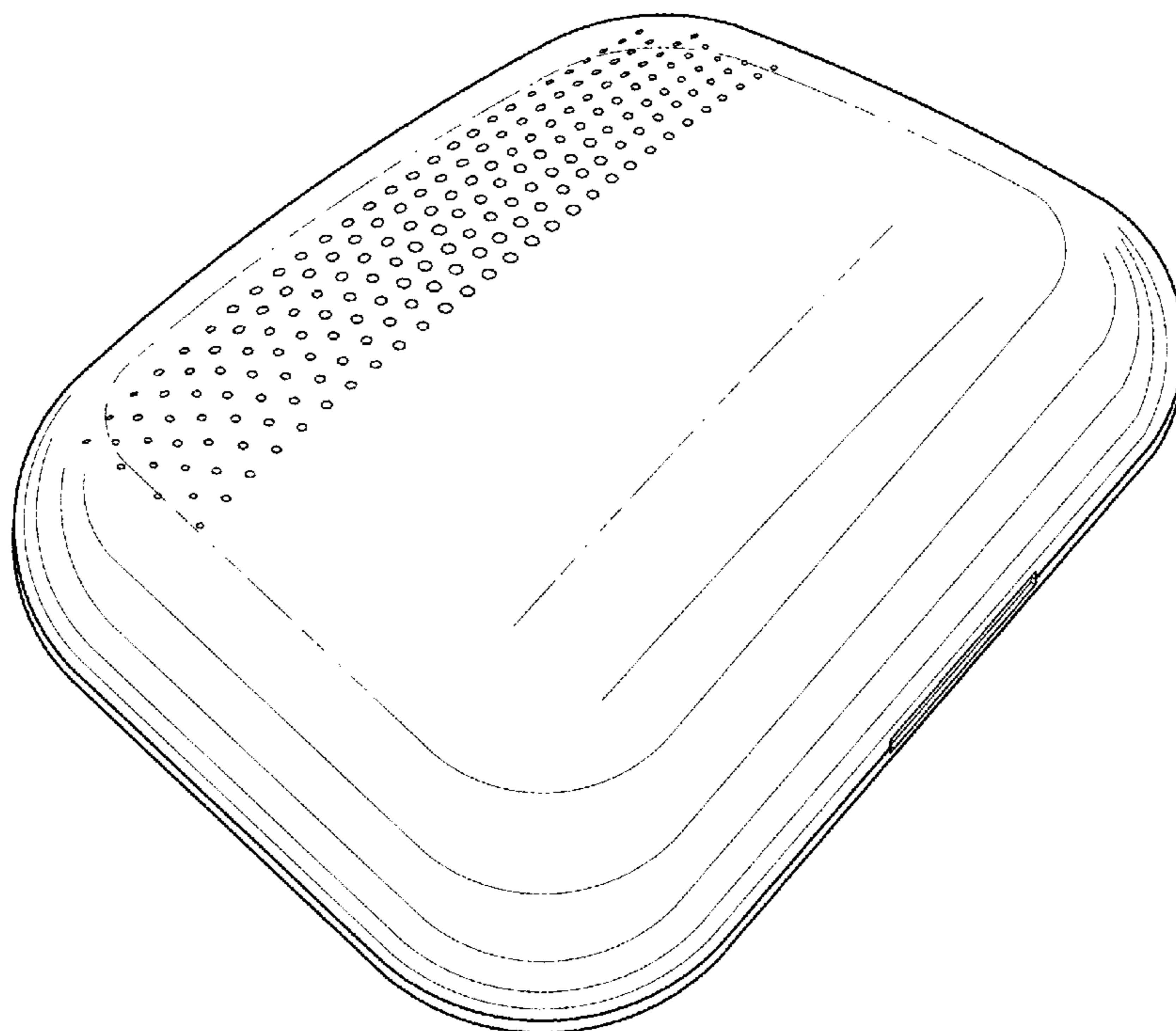

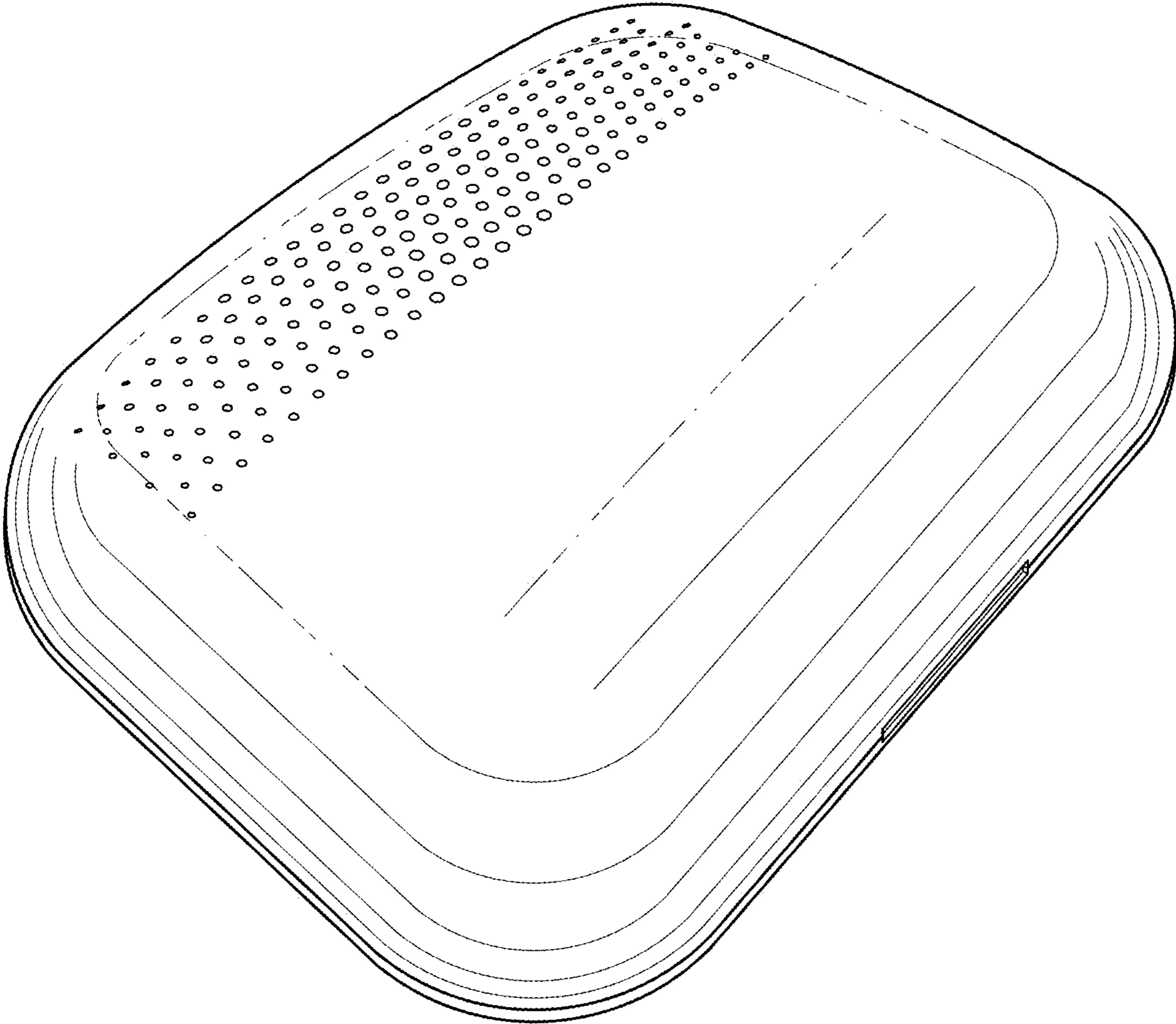

FIG. 1

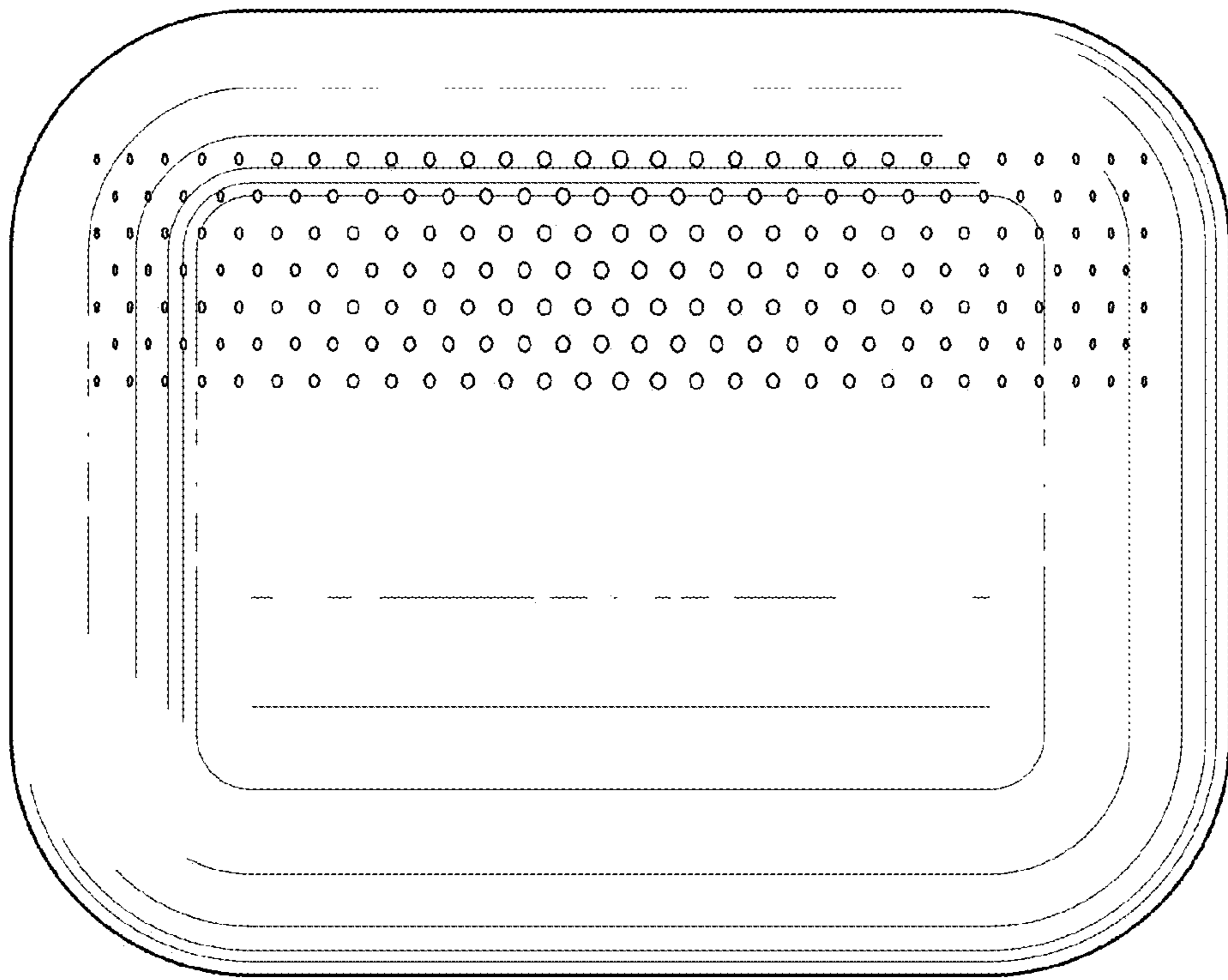

FIG. 2

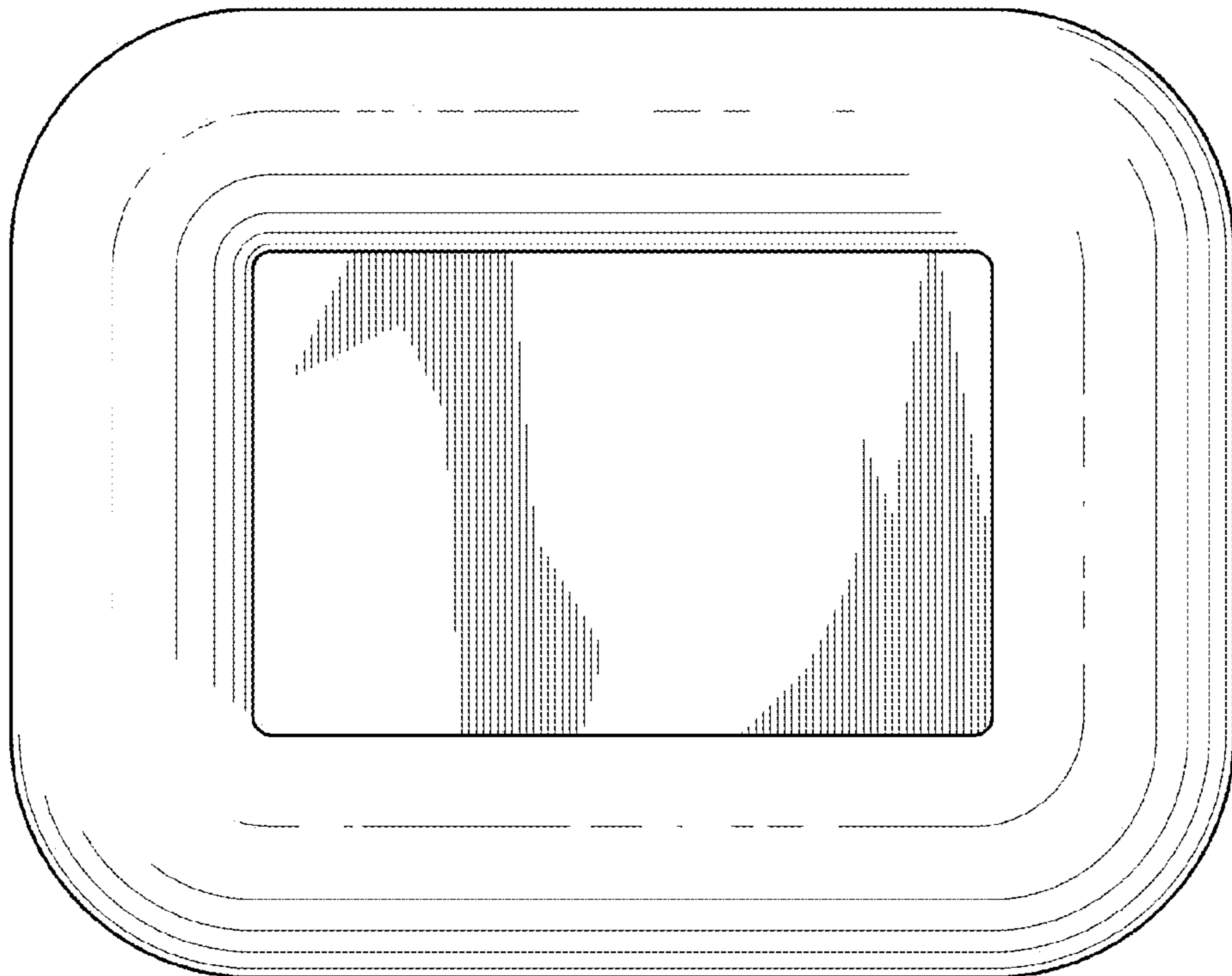

FIG. 3

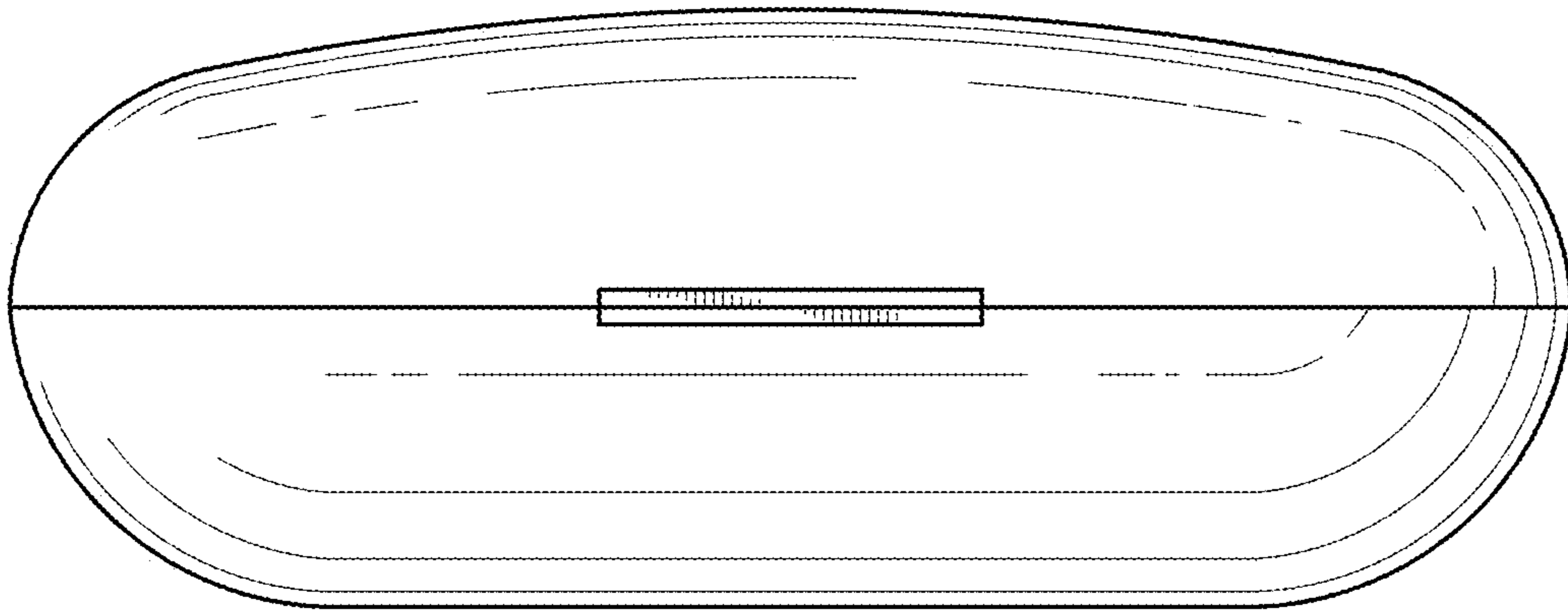

FIG. 4

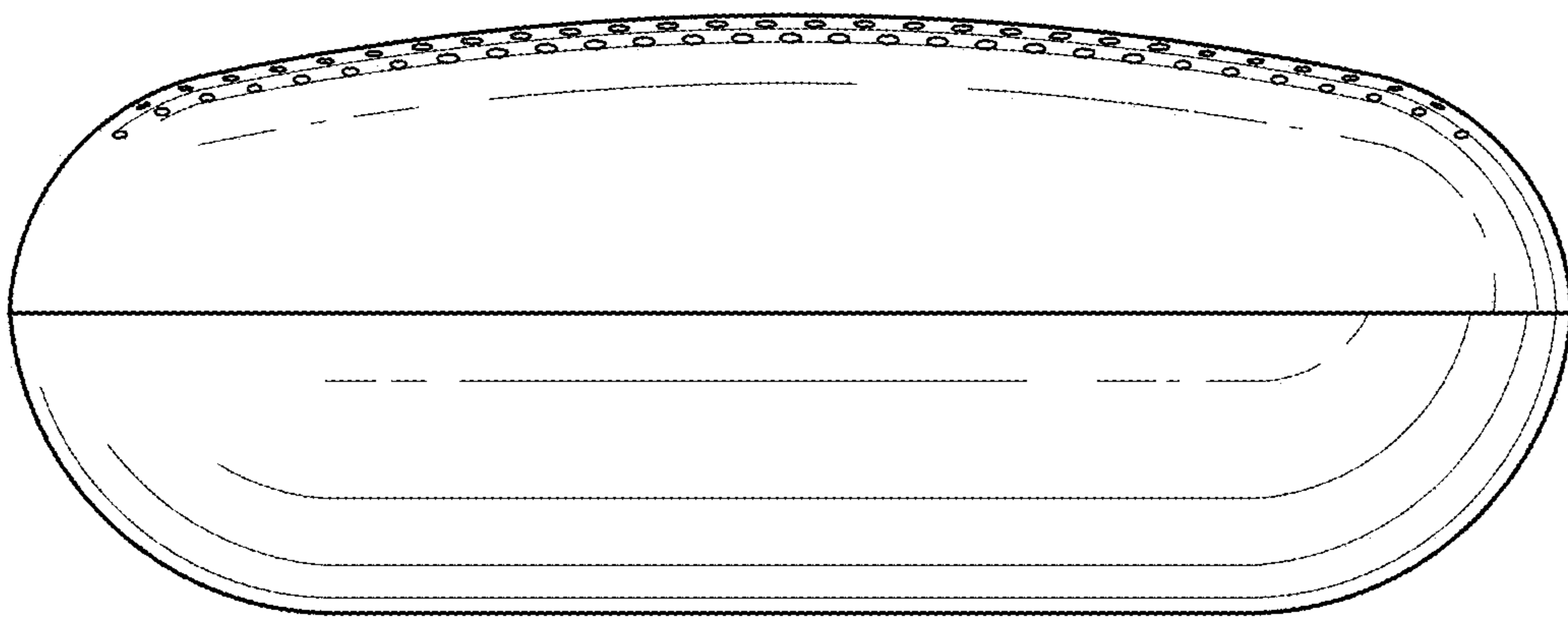

FIG. 5

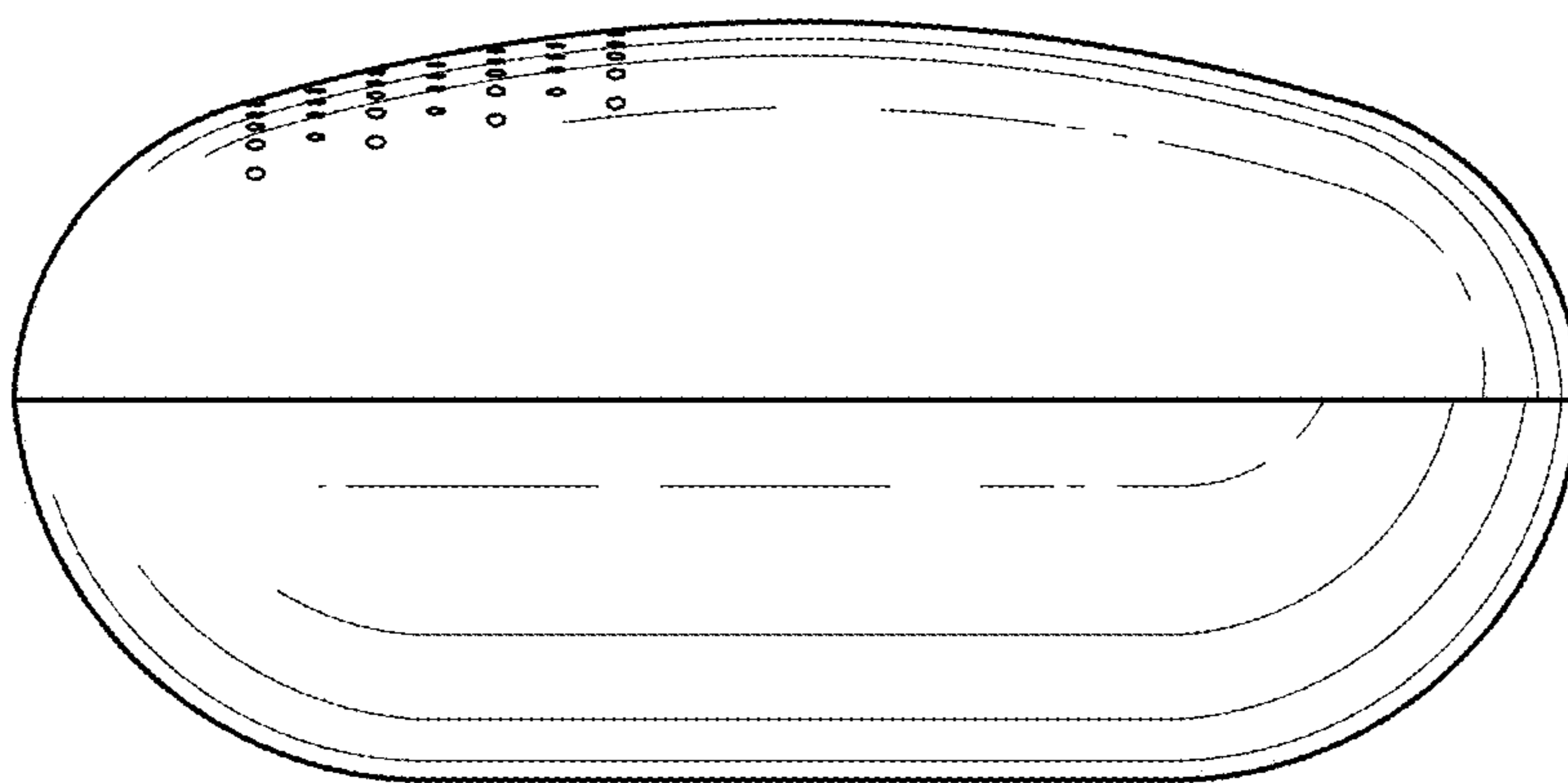

FIG. 6

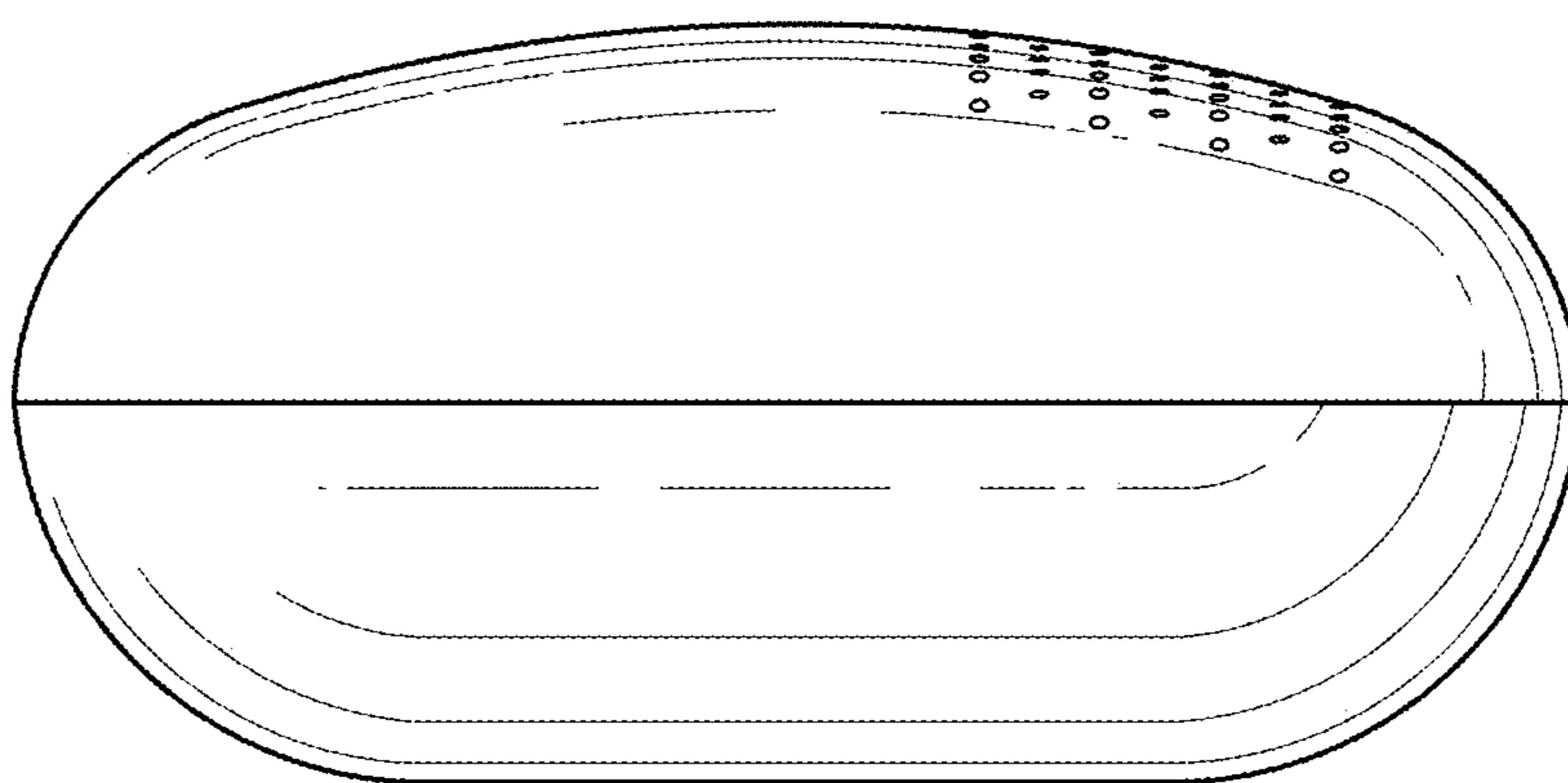
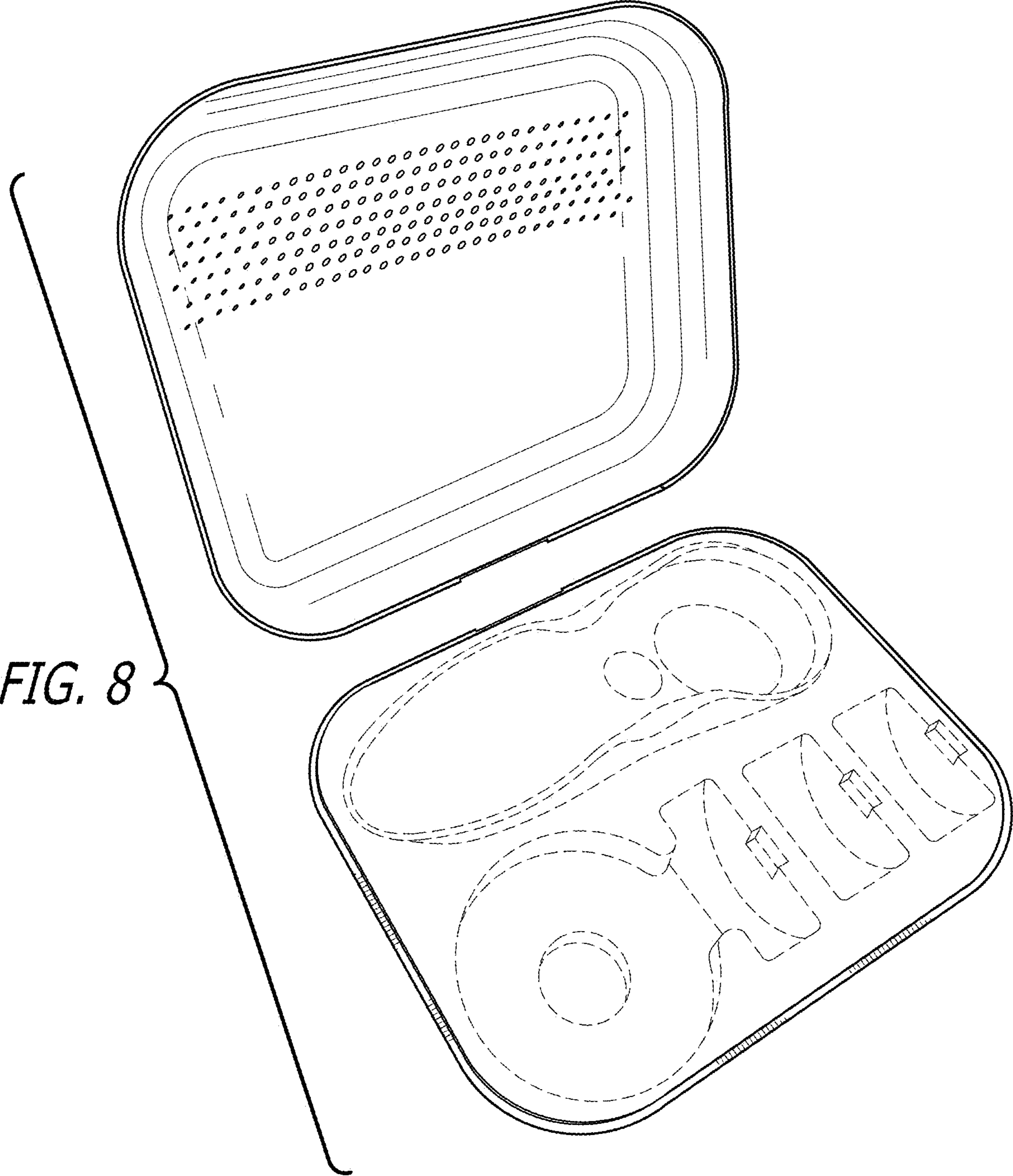

FIG. 7



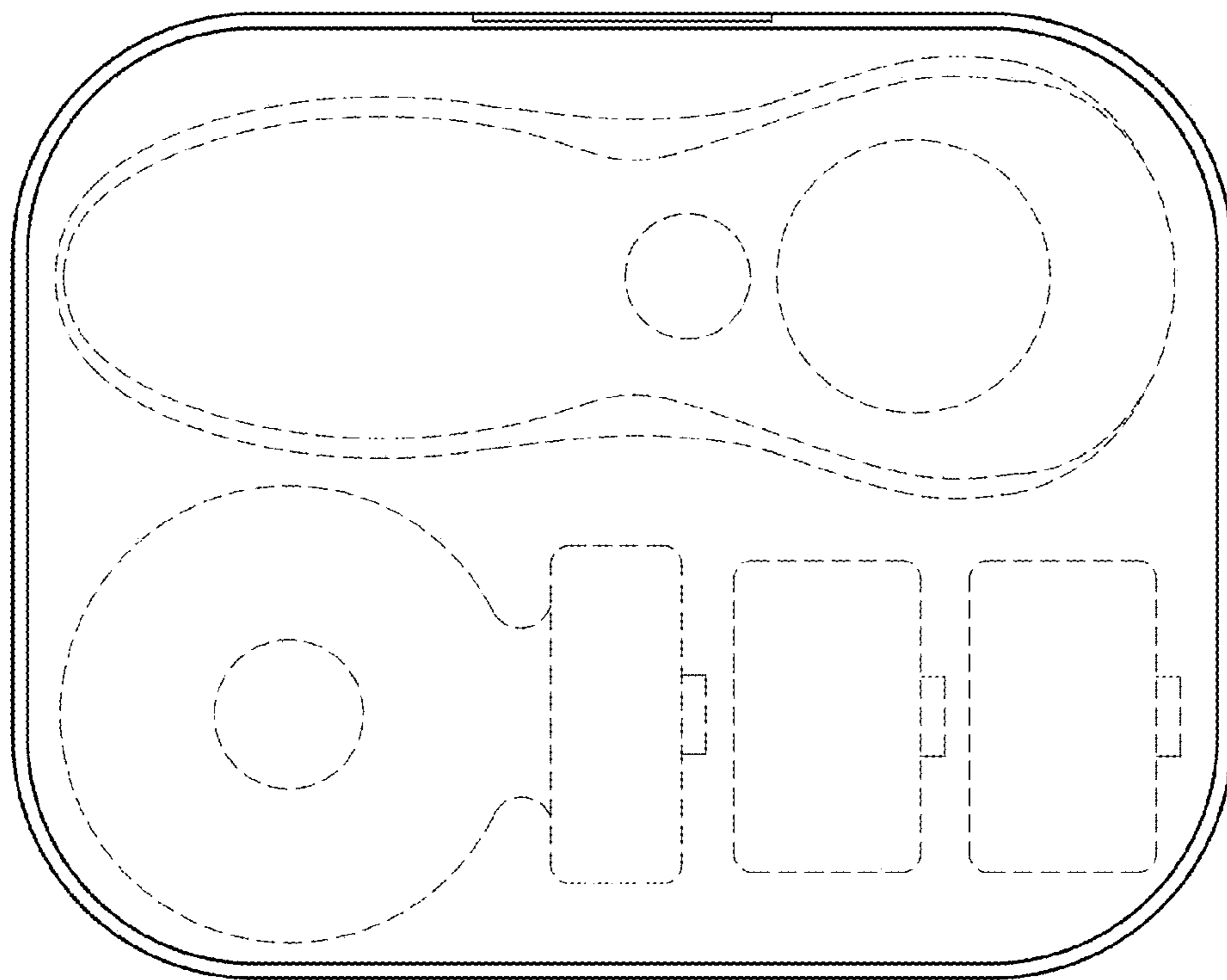

FIG. 9

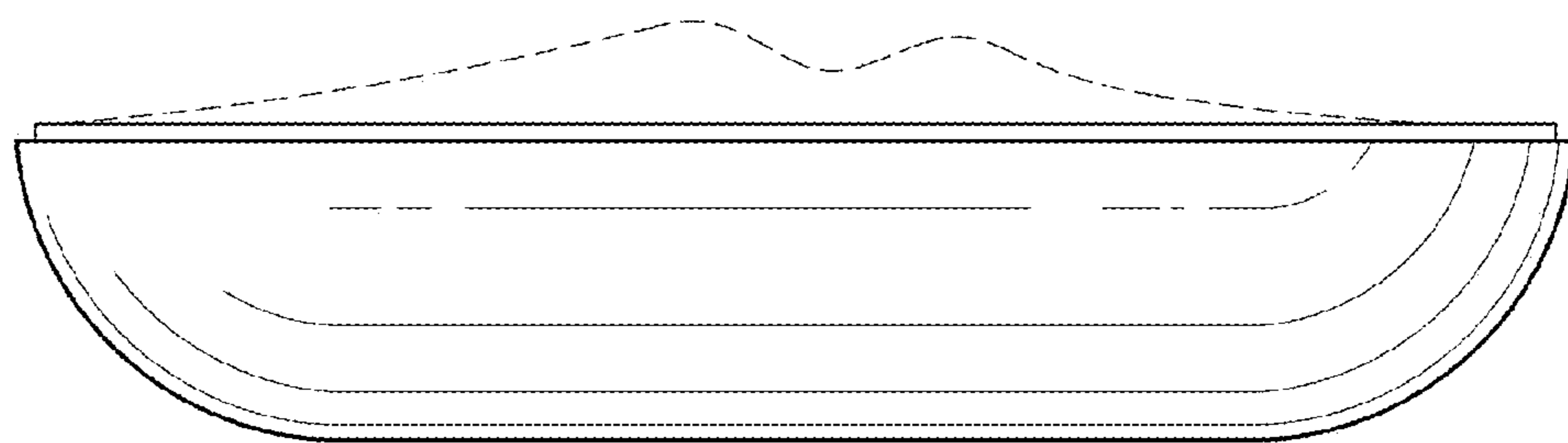

FIG. 10

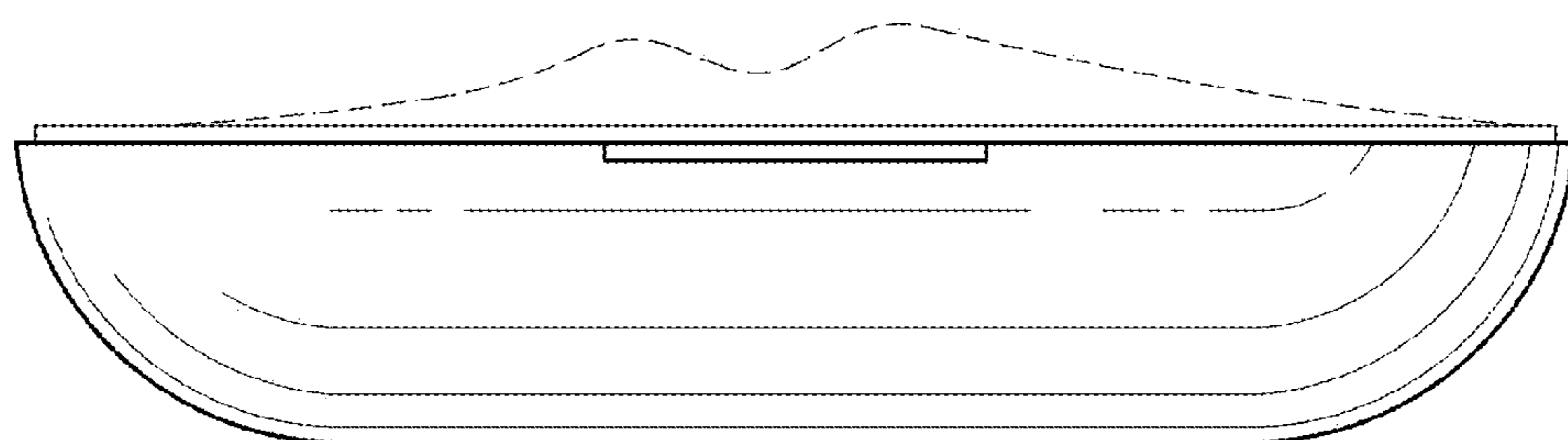

FIG. 11

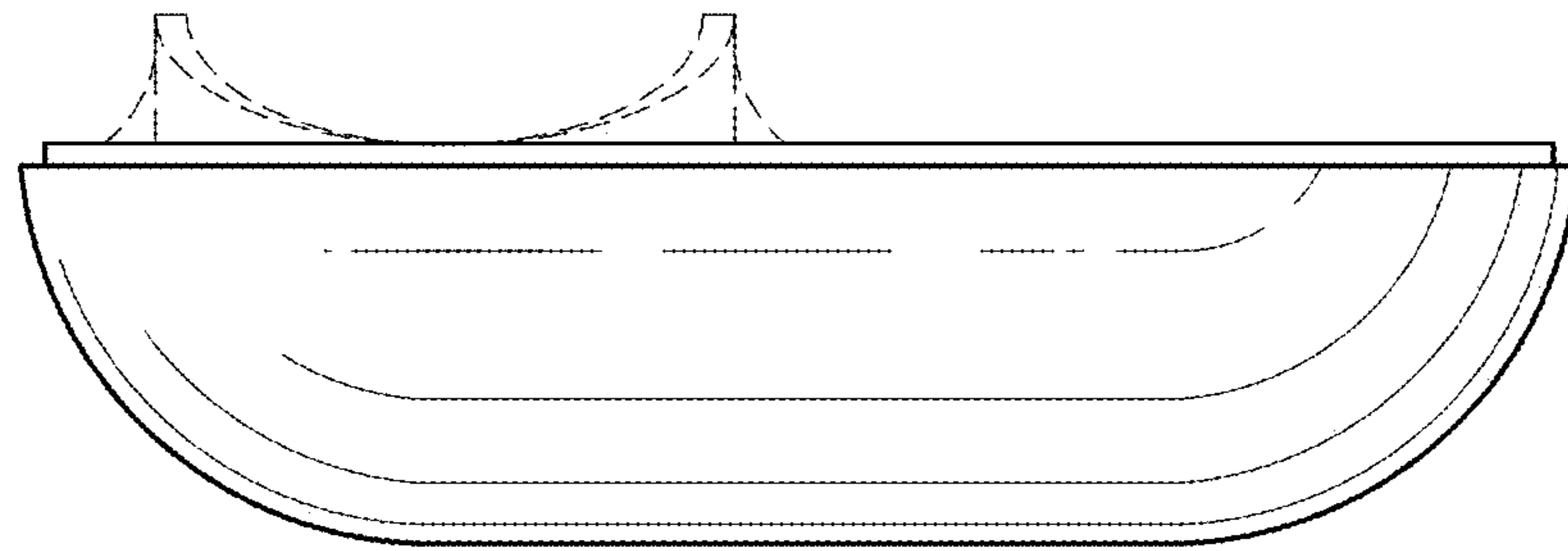

FIG. 12

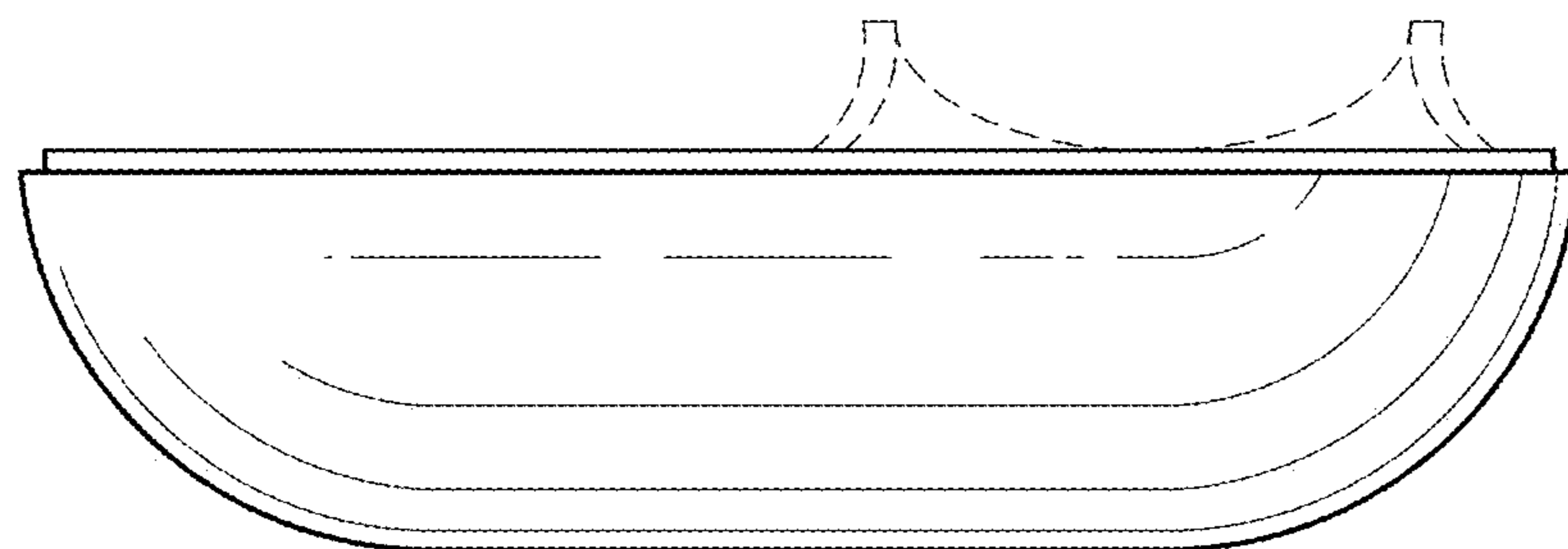

FIG. 13