



US00D909694S

(12) **United States Design Patent** (10) **Patent No.:** **US D909,694 S**
Ayers et al. (45) **Date of Patent:** **** Feb. 2, 2021**

(54) **FABRIC CARE APPLIANCE**

FOREIGN PATENT DOCUMENTS

(71) Applicant: **WHIRLPOOL CORPORATION**,
Benton Harbor, MI (US)

CN 302497340 * 7/2013
EP 0406115 A1 1/1991

(Continued)

(72) Inventors: **Kevin B. Ayers**, St. Joseph, MI (US);
Andrew C. Kubasiak, St. Joseph, MI
(US); **Anna C. Schelling**, Stevensville,
MI (US); **Mark W. Schulz**, Benton
Harbor, MI (US)

OTHER PUBLICATIONS

Dishwashers | Stainless Steel & Energy Efficient, Samsung
website 2020, <https://www.samsung.com/us/home-appliances/dishwashers/all-dishwashers/>, site visited Jun. 11, 2020.*

(73) Assignee: **Whirlpool Corporation**, Benton
Harbor, MI (US)

Primary Examiner — John R Yeh

(**) Term: **15 Years**

(74) *Attorney, Agent, or Firm* — Price Heneveld LLP

(21) Appl. No.: **29/682,855**

(57) **CLAIM**

(22) Filed: **Mar. 8, 2019**

The ornamental design for a fabric care appliance, as shown
and described.

(51) **LOC (13) Cl.** **15-05**

(52) **U.S. Cl.**
USPC **D32/6**

(58) **Field of Classification Search**
USPC D32/2-3, 5-7, 12-13, 25-29.1
CPC A47L 15/42; A47L 15/00; B65D 47/06;
D06F 23/06; D06F 37/26
See application file for complete search history.

DESCRIPTION

FIG. 1 is a front perspective view of a fabric care appliance
according to the design in a first configuration;
FIG. 2 is a front elevation view thereof;
FIG. 3 is a rear elevation view thereof;
FIG. 4 is a left side elevation view thereof;
FIG. 5 is a right side elevation view thereof;
FIG. 6 is a top plan view thereof;
FIG. 7 is a bottom plan view thereof;
FIG. 8 is a front perspective view of the fabric care appliance
of the design in a second configuration;
FIG. 9 is a front elevation view thereof;
FIG. 10 is a rear elevation view thereof;
FIG. 11 is a left side elevation view thereof;
FIG. 12 is a right side elevation view thereof;
FIG. 13 is a top plan view thereof; and,
FIG. 14 is a bottom plan view thereof.
The portions of the article shown in broken line form no part
of the claimed design.

(56) **References Cited**

U.S. PATENT DOCUMENTS

5,365,959 A * 11/1994 Favaro A47L 15/4257
134/113
5,453,586 A * 9/1995 Stottmann H01H 13/70
200/302.2
5,496,104 A 3/1996 Arnold et al.
D493,582 S * 7/2004 Ott D32/3
D493,583 S * 7/2004 Kaczmarek D32/3
D510,781 S * 10/2005 Seo D32/2
D518,249 S * 3/2006 Seo D32/2
7,201,175 B2 * 4/2007 Deboer A47L 15/0086
134/115 R
D543,321 S * 5/2007 Jeon D32/2

(Continued)

1 Claim, 14 Drawing Sheets

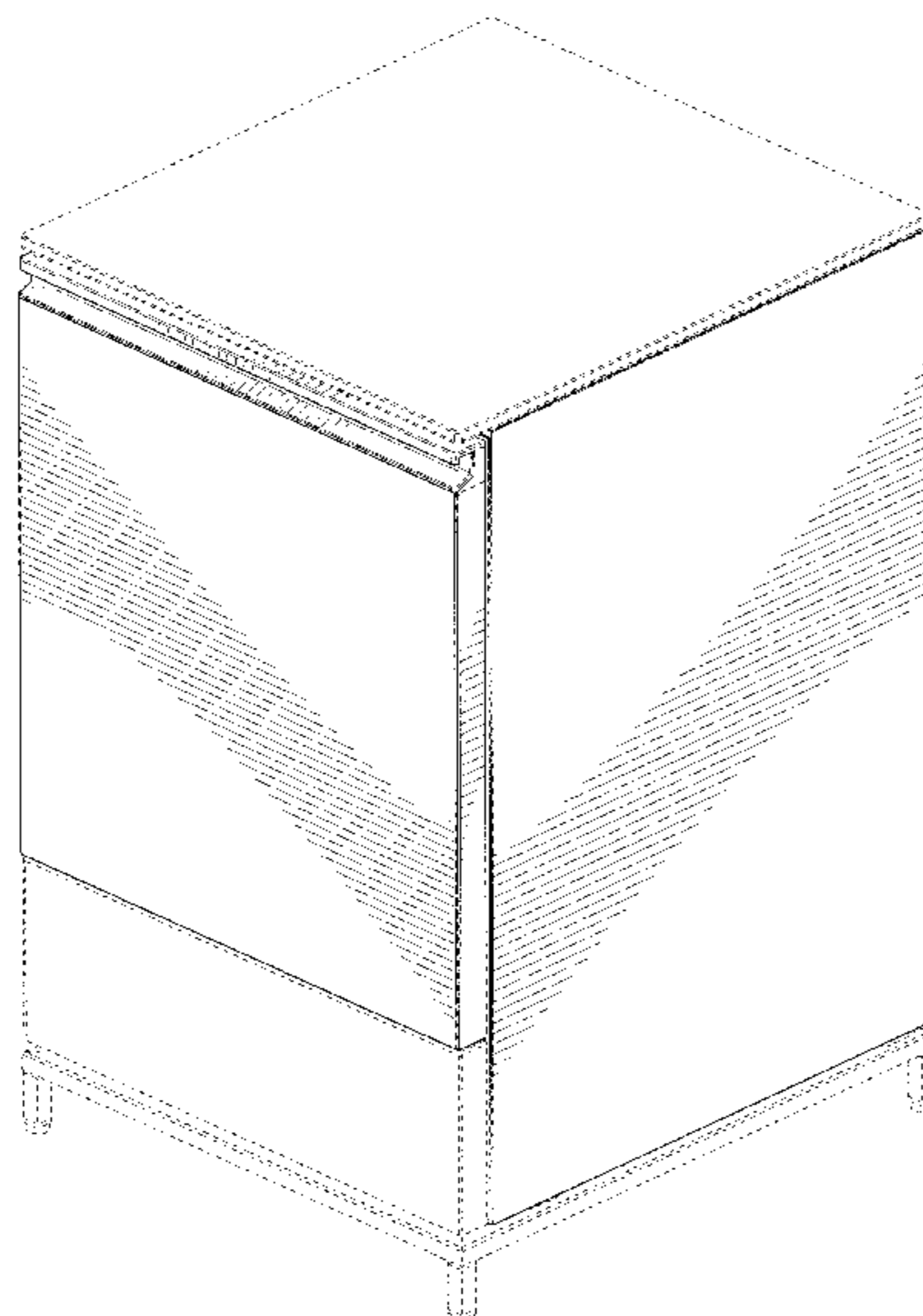

(56)

References Cited

U.S. PATENT DOCUMENTS

D549,404	S *	8/2007	Jeon	D32/2
D627,937	S *	11/2010	Kim	D32/2
7,928,857	B2 *	4/2011	Olesen	A47L 15/4293
					340/686.1
D656,692	S *	3/2012	Kim	D32/2
D658,828	S *	5/2012	Kim	D32/2
D673,742	S *	1/2013	Eng	D32/2
D677,023	S *	2/2013	Borjesson	D32/2
D682,491	S *	5/2013	Kim	D32/2
8,622,487	B2	1/2014	Jung		
8,876,228	B2	11/2014	Laible et al.		
9,303,916	B2	4/2016	Ozyuksel et al.		
D806,960	S *	1/2018	Tong	D32/2
D827,224	S *	8/2018	Lee	D32/3
D827,225	S *	8/2018	Lee	D32/3
2008/0011342	A1 *	1/2008	Ryu	A47L 15/4257
					134/57 DL

FOREIGN PATENT DOCUMENTS

EP	1741822	A1	1/2000
EP	2108729	A1	4/2008
FR	2521182	A3	8/1983
GB	2114432	A	8/1983
WO	2017133782	A1	8/2017
WO	2017212373	A1	12/2017

* cited by examiner

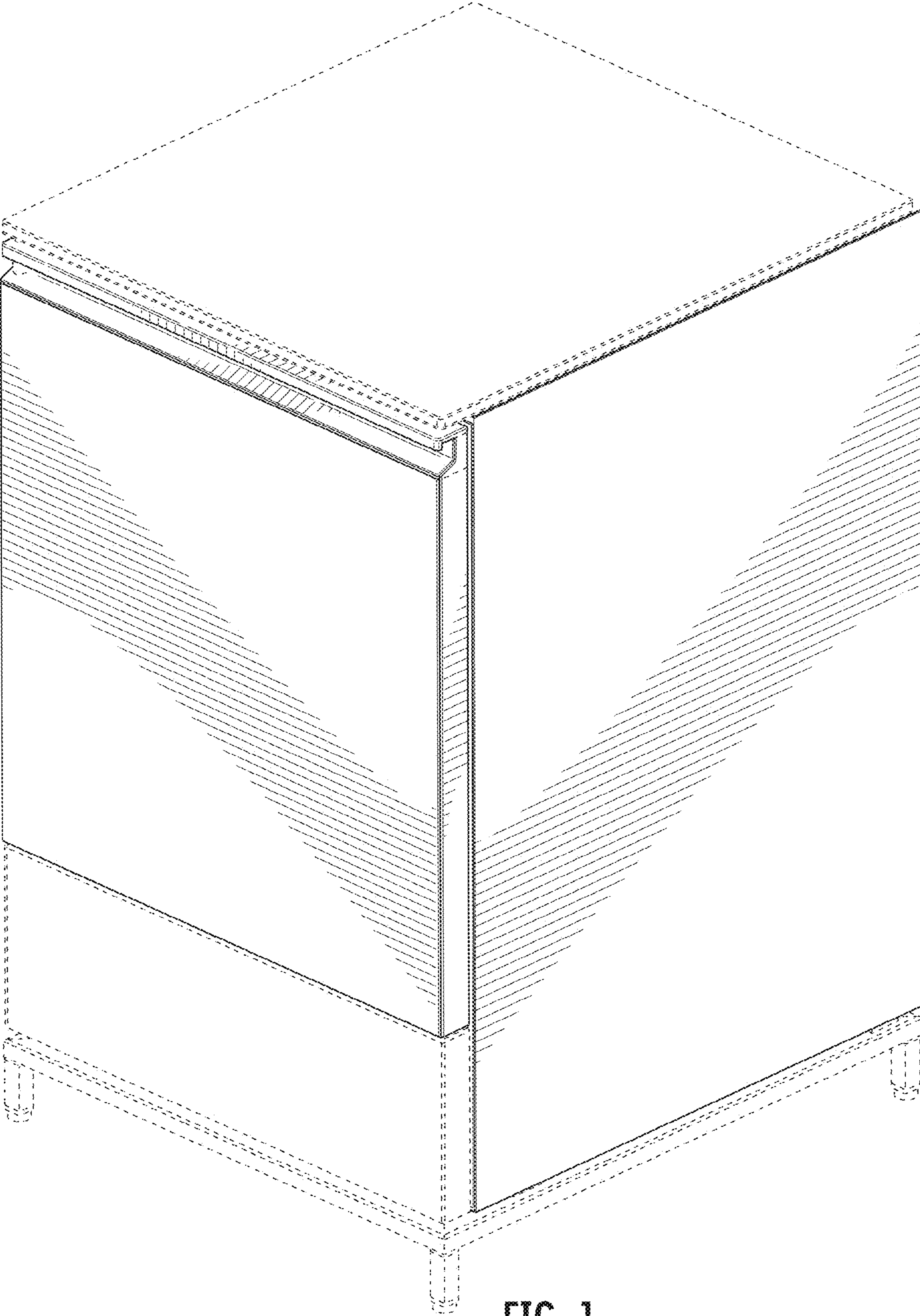

FIG. 1

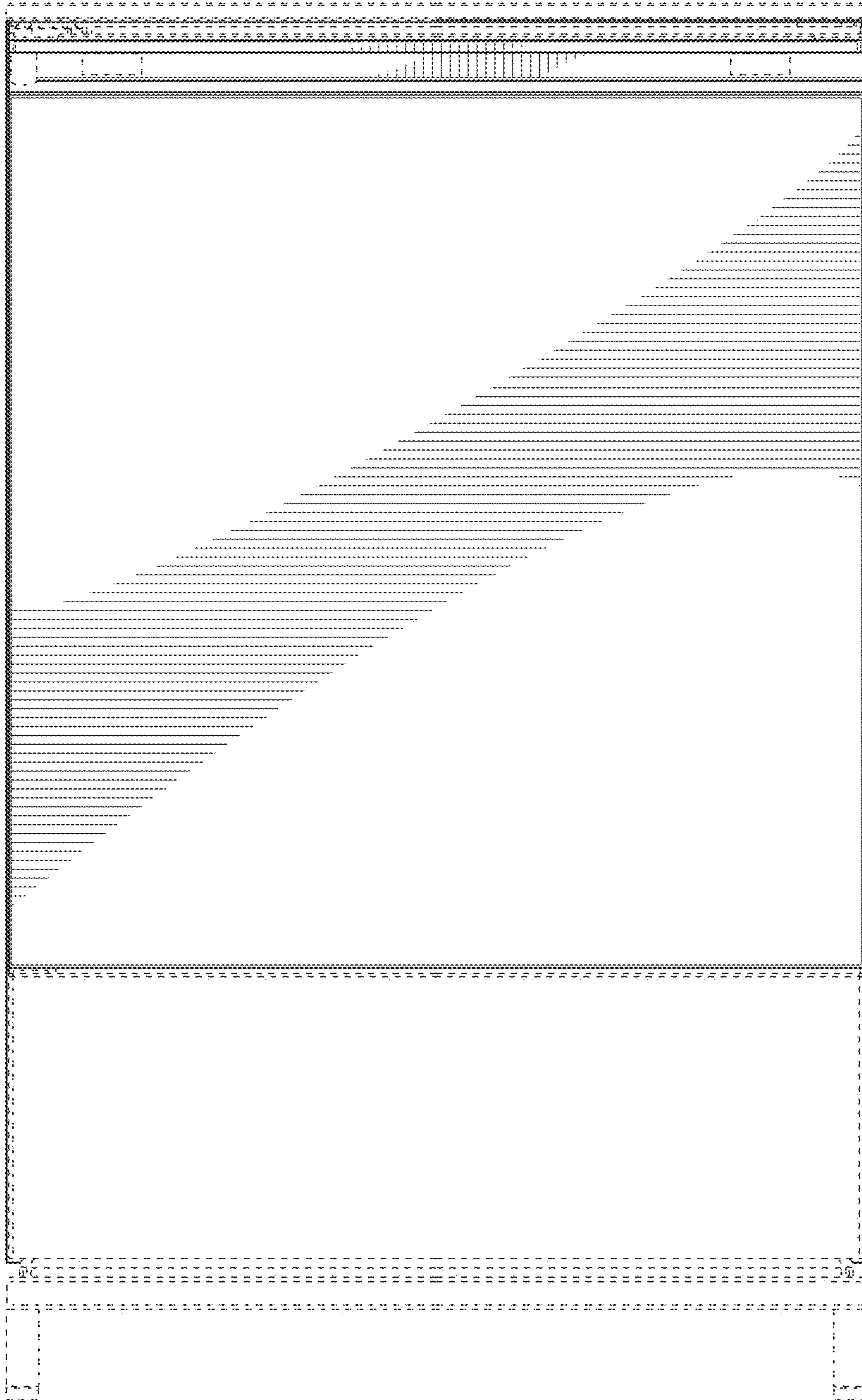

FIG. 2

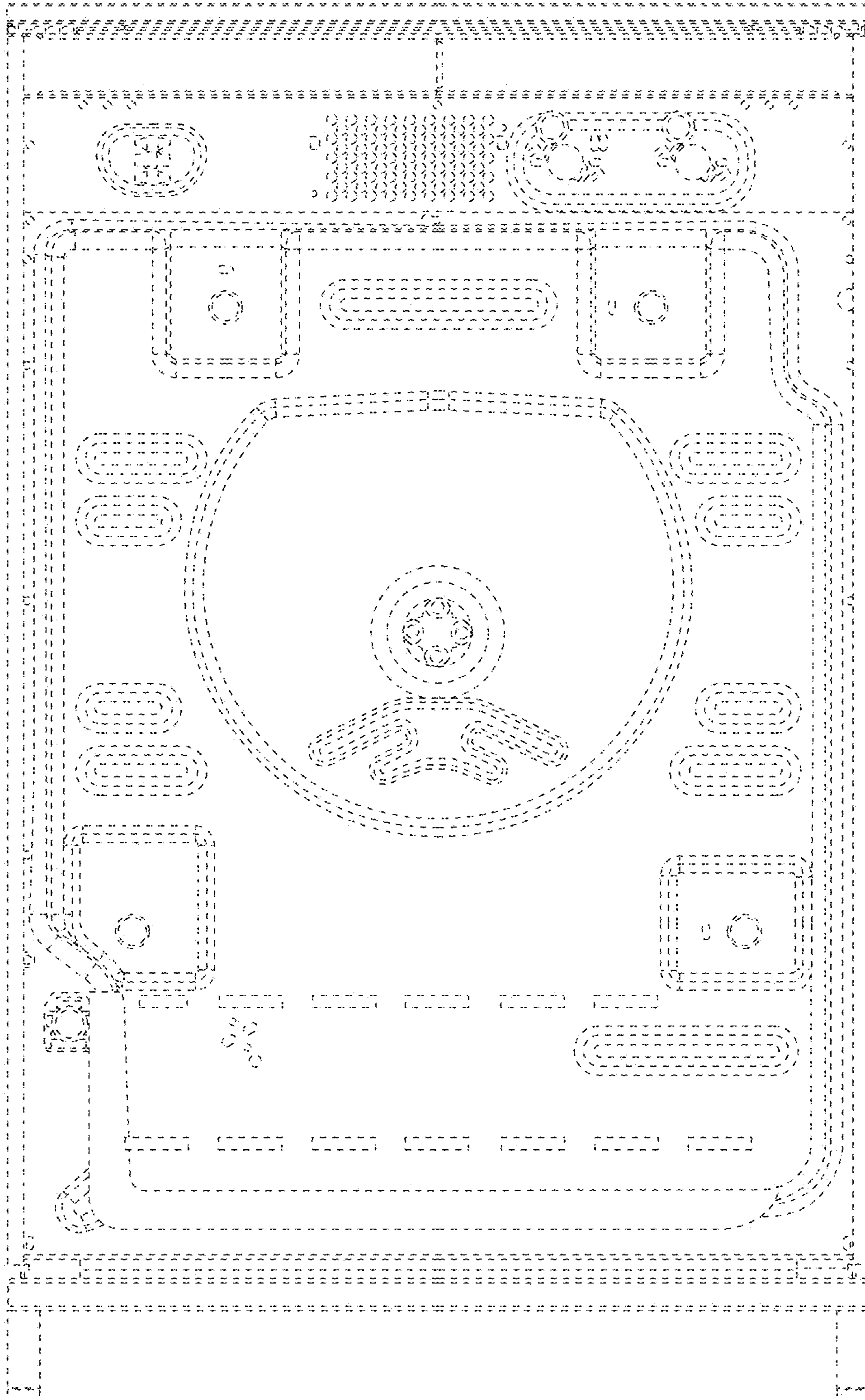

FIG. 3

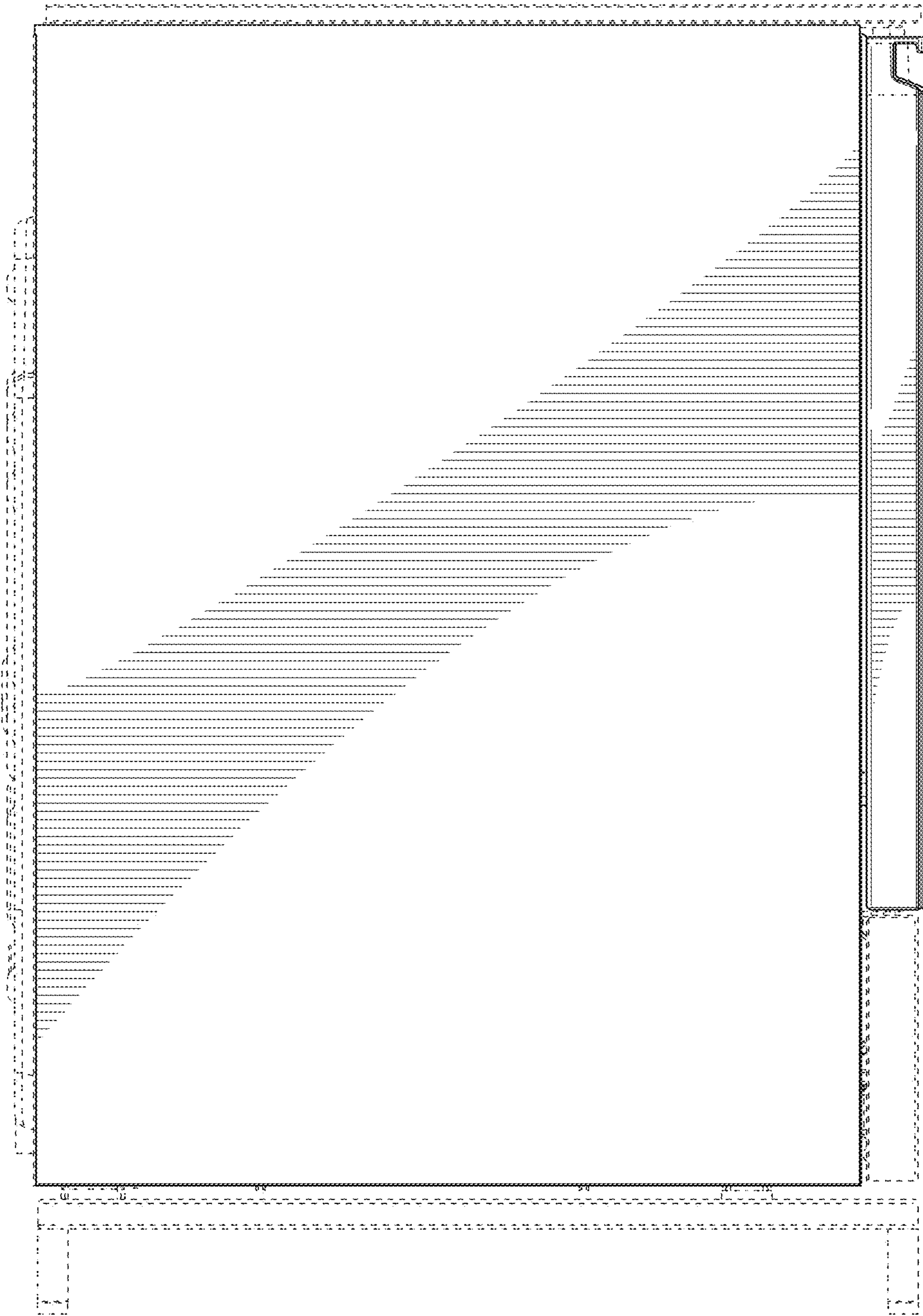

FIG. 4

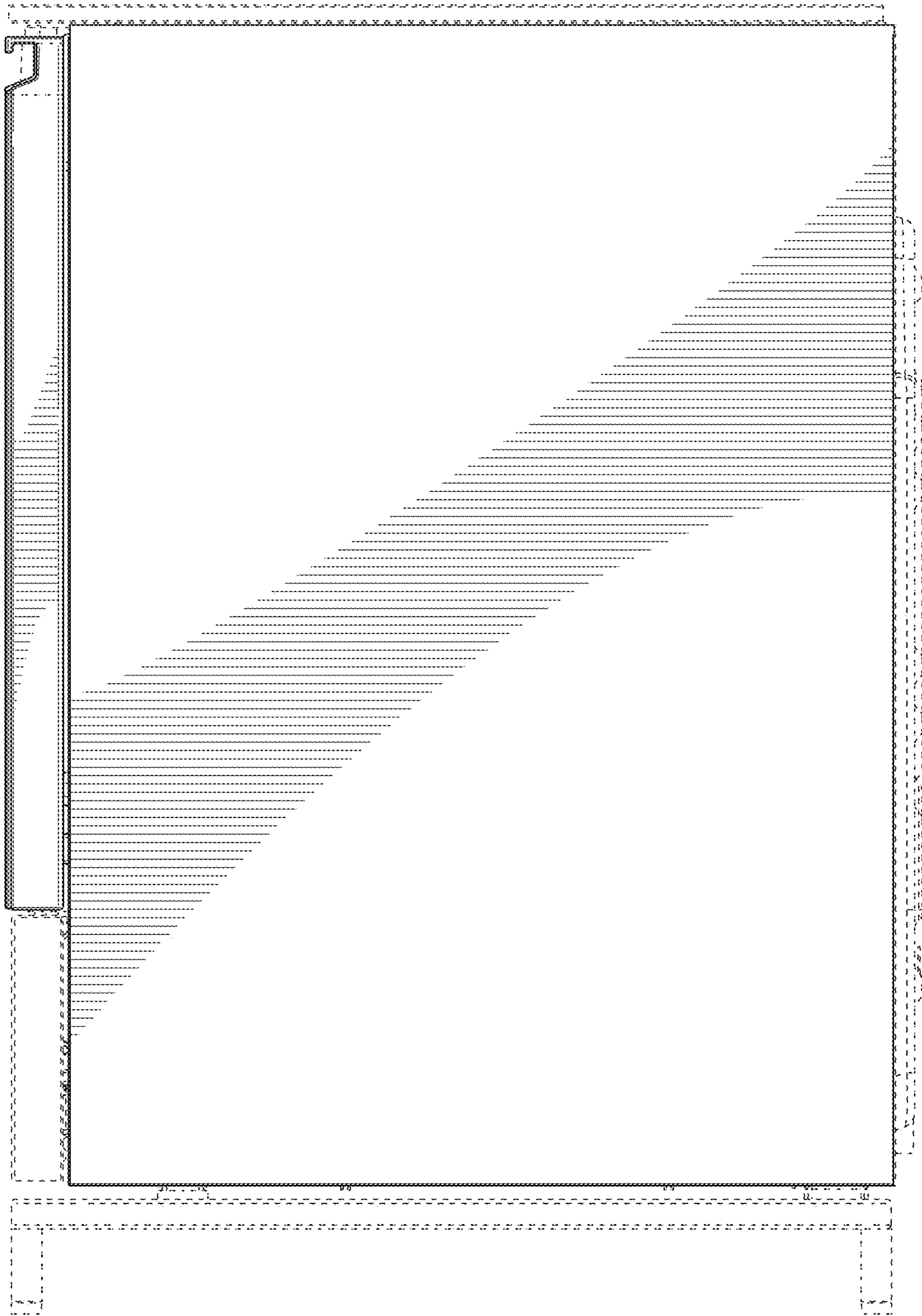

FIG. 5



FIG. 6

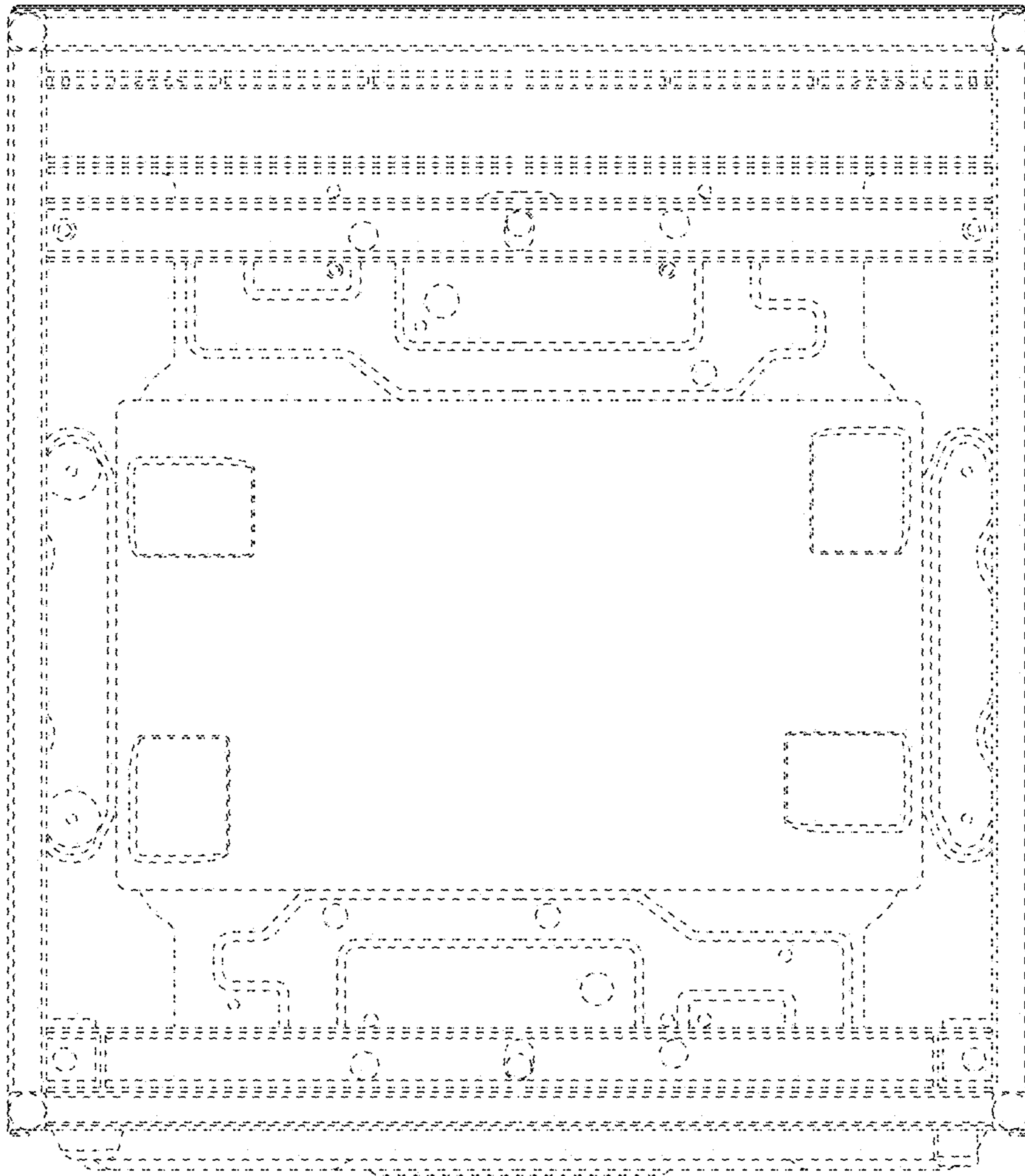

FIG. 7

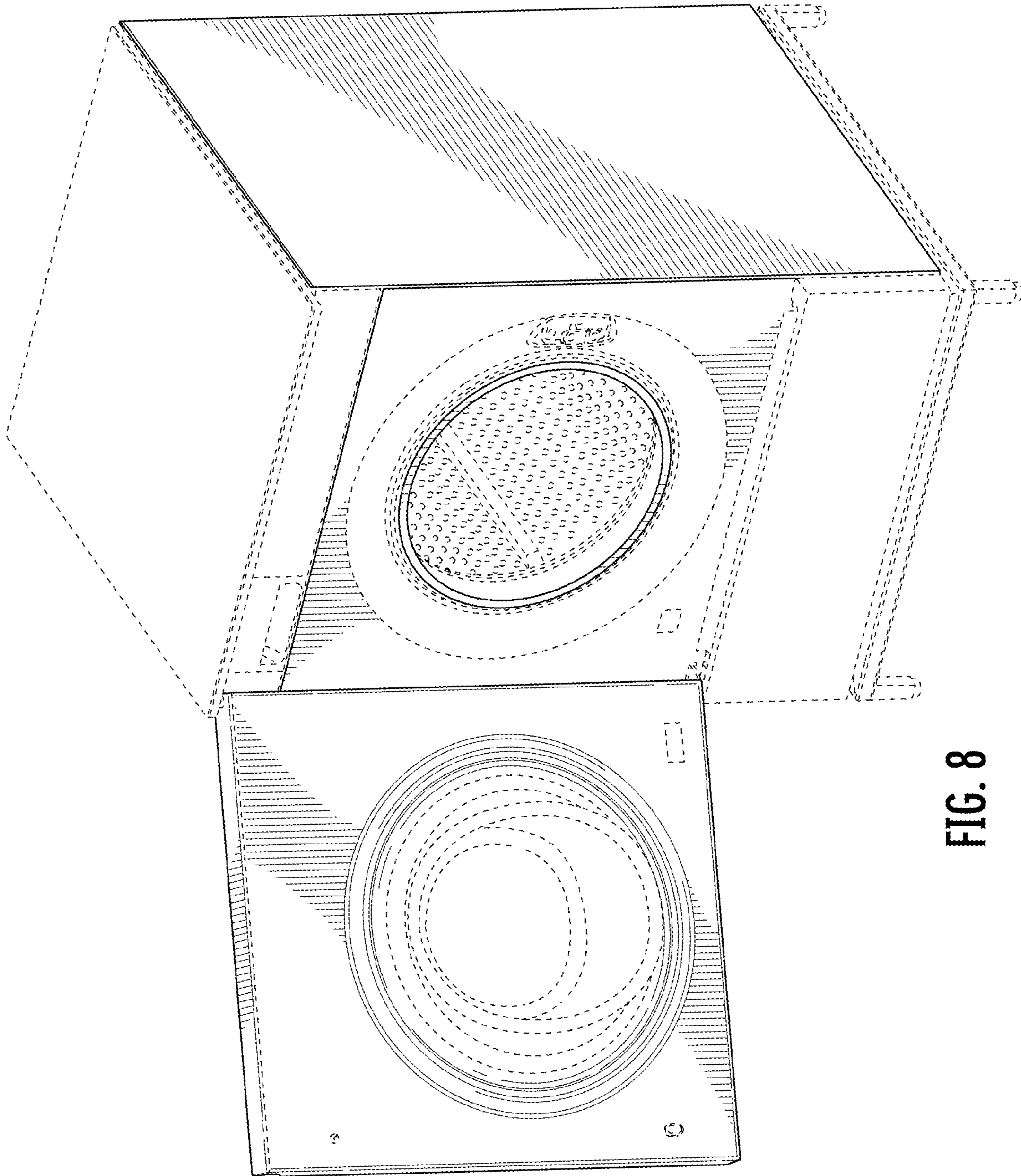

FIG. 8

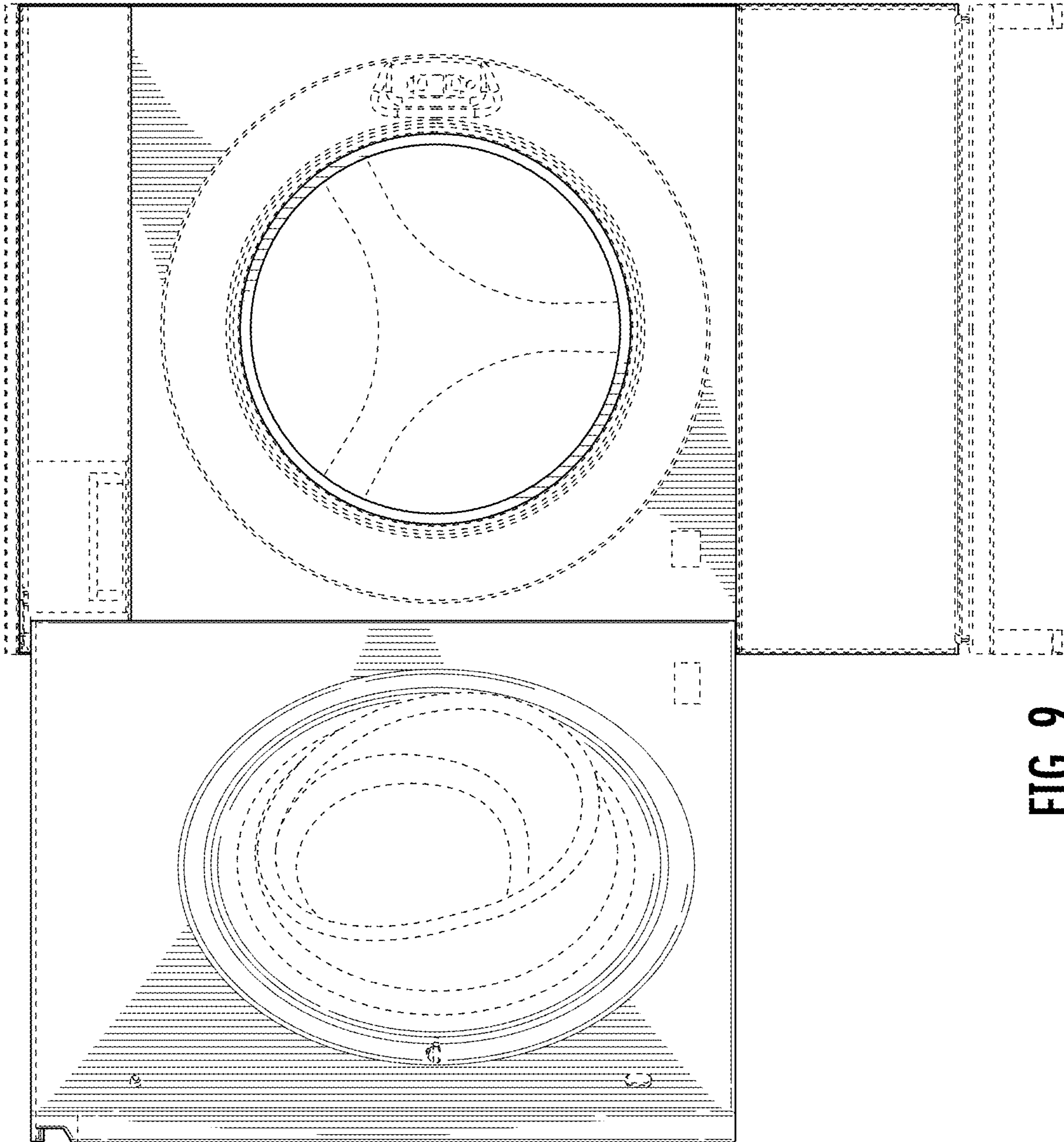

FIG. 9

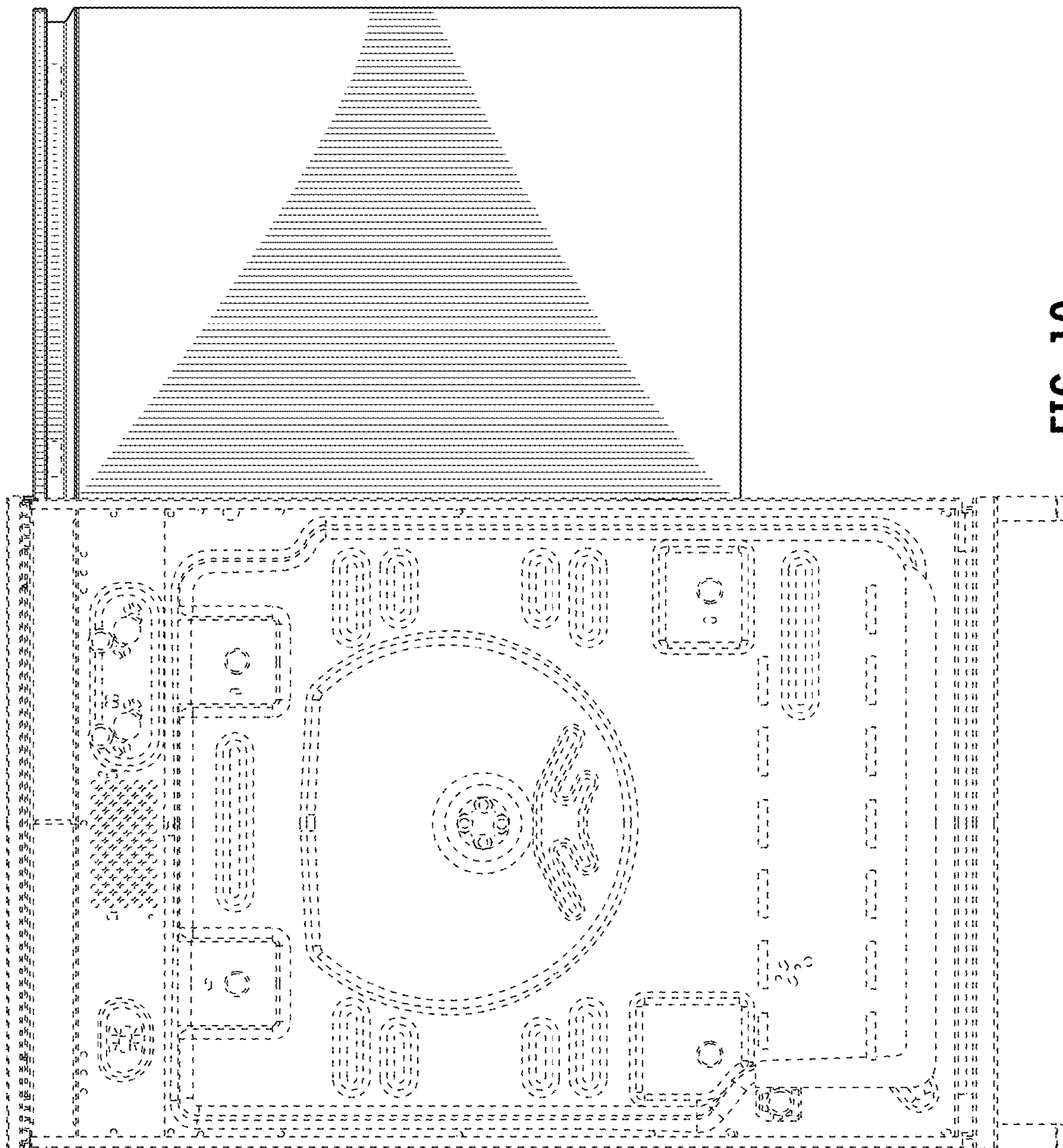

FIG. 10

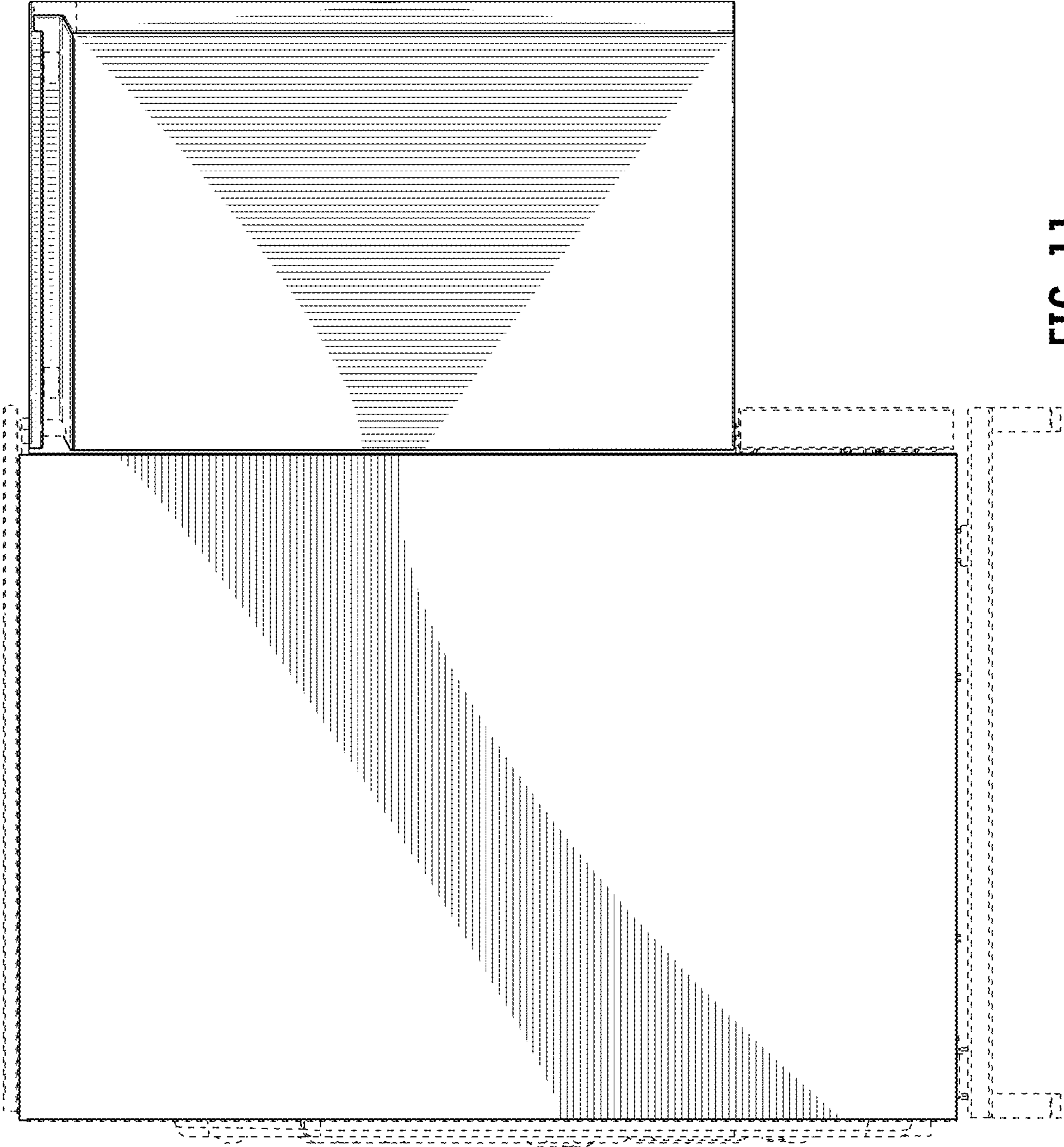

FIG. 11

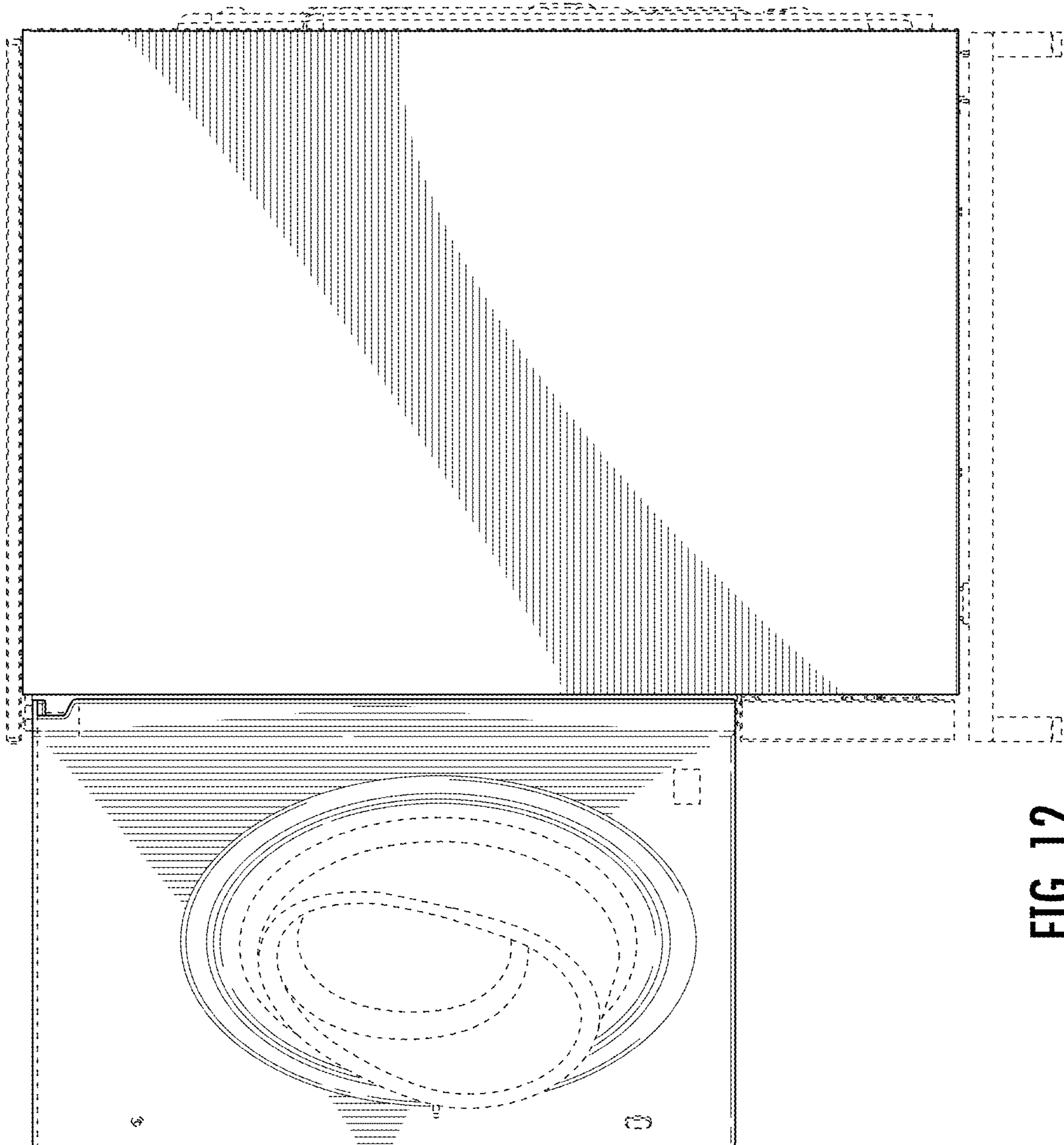

FIG. 12

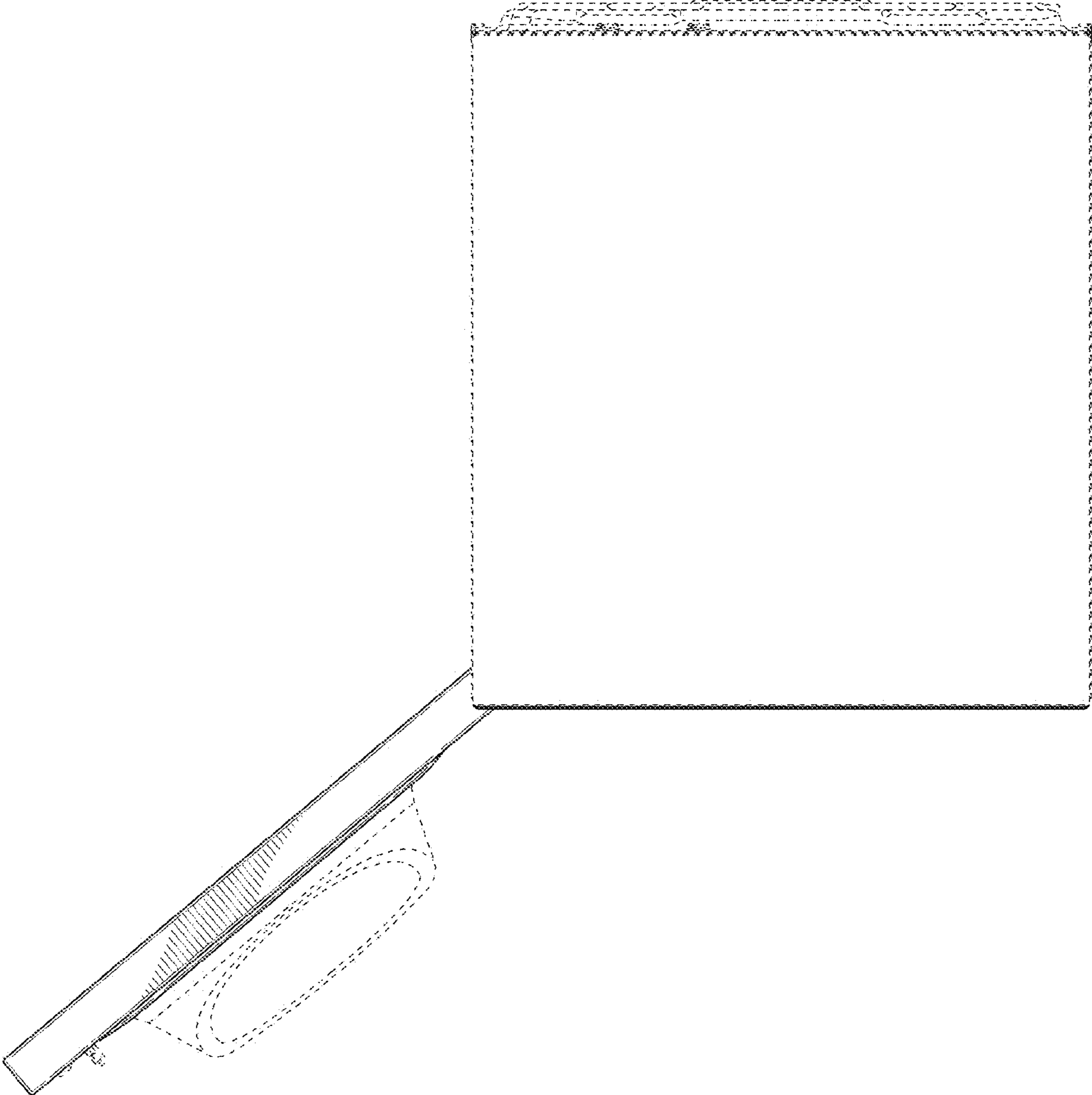

FIG. 13

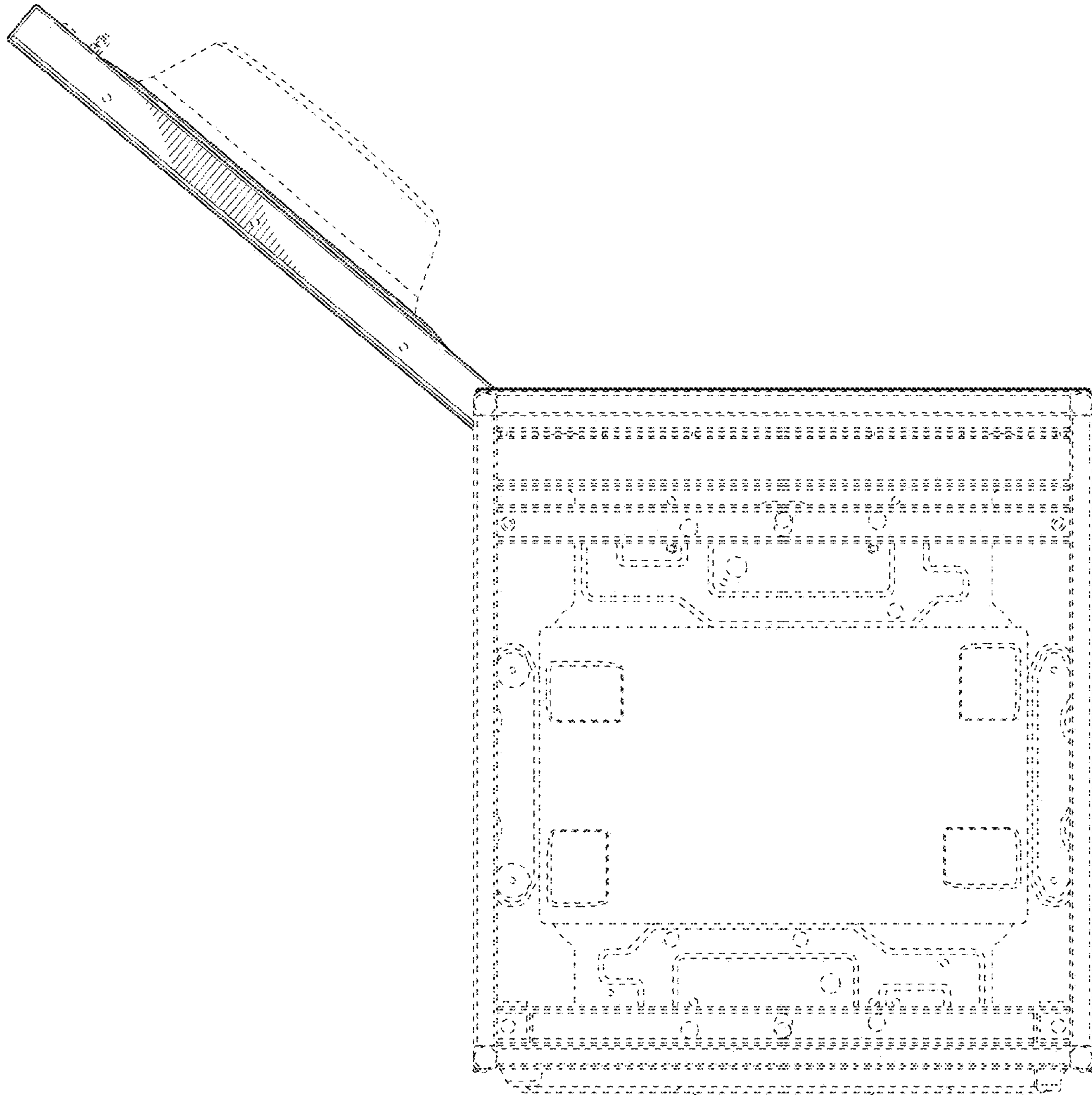

FIG. 14