



US00D909693S

(12) **United States Design Patent** (10) **Patent No.:** **US D909,693 S**  
**Yoon et al.** (45) **Date of Patent:** **\*\* Feb. 2, 2021**

(54) **CLOTHING CARE MACHINE**

<<http://www.ddaily.co.kr>>, <http://www.ddaily.co.kr/news/article.html?no=112004>.

(71) Applicant: **Samsung Electronics Co., Ltd.**,  
Suwon-si (KR)

(Continued)

(72) Inventors: **Hyunwoo Yoon**, Seongnam-si (KR);  
**Sanghun Yoon**, Seoul (KR); **Jinsook Park**,  
Uiwang-si (KR); **Sodam Park**, Seoul (KR);  
**Kangkyung Lee**, Seoul (KR)

*Primary Examiner* — Michelle E. Wilson  
(74) *Attorney, Agent, or Firm* — NSIP Law

(73) Assignee: **Samsung Electronics Co., Ltd.**,  
Suwon-si (KR)

(57) **CLAIM**

We claim the ornamental design for a clothing care machine,  
as shown and described.

(\*\*) Term: **15 Years**

**DESCRIPTION**

(21) Appl. No.: **29/680,225**

(22) Filed: **Feb. 14, 2019**

(30) **Foreign Application Priority Data**

Aug. 16, 2018 (KR) ..... 30-2018-0038061

(51) **LOC (13) Cl.** ..... **15-05**

(52) **U.S. Cl.**  
USPC ..... **D32/6**

(58) **Field of Classification Search**  
USPC ..... D32/1-3, 5-6, 10, 25

(Continued)

(56) **References Cited**

**U.S. PATENT DOCUMENTS**

D197,085 S \* 12/1963 Bequette ..... D32/8  
D532,563 S \* 11/2006 Kim ..... D32/6

(Continued)

**FOREIGN PATENT DOCUMENTS**

KR 30-2009-0002526 7/2010  
KR 30-2009-0056236 3/2011

(Continued)

**OTHER PUBLICATIONS**

Lee Soo-hwan, "LG Electronics apparel manager 'styler' worried  
about . . . Become a B2B business", [2013], Dec. 12, 2013,

FIG. 1 is a front perspective view of a clothing care machine showing our new design;  
 FIG. 2 is a front view thereof;  
 FIG. 3 is a rear view thereof;  
 FIG. 4 is a left-side view thereof;  
 FIG. 5 is a right-side view thereof;  
 FIG. 6 is a top view thereof;  
 FIG. 7 is a bottom view thereof;  
 FIG. 8 is a cross-sectional view thereof taken through line 8-8 of FIG. 2;  
 FIG. 9 is a cross-sectional view thereof taken through line 9-9 of FIG. 2;  
 FIG. 10 is a front view showing the claimed design isolated from the article in which it is embodied to allow for enlargement;  
 FIG. 11 is a bottom perspective view thereof;  
 FIG. 12 is a right-side view thereof;  
 FIG. 13 is a bottom view thereof;  
 FIG. 14 is another bottom perspective view thereof, shown in an example state of use; and,  
 FIG. 15 is a cross-sectional view of the clothing care machine taken along line 9-9 in FIG. 2 shown in an example state of use.

The broken lines in the figures showing portions of the clothing care machine form no part of the claimed design. The broken lines in FIGS. 14 and 15 showing the hanger depict environment structure and form no part of the claimed design.

**1 Claim, 15 Drawing Sheets**

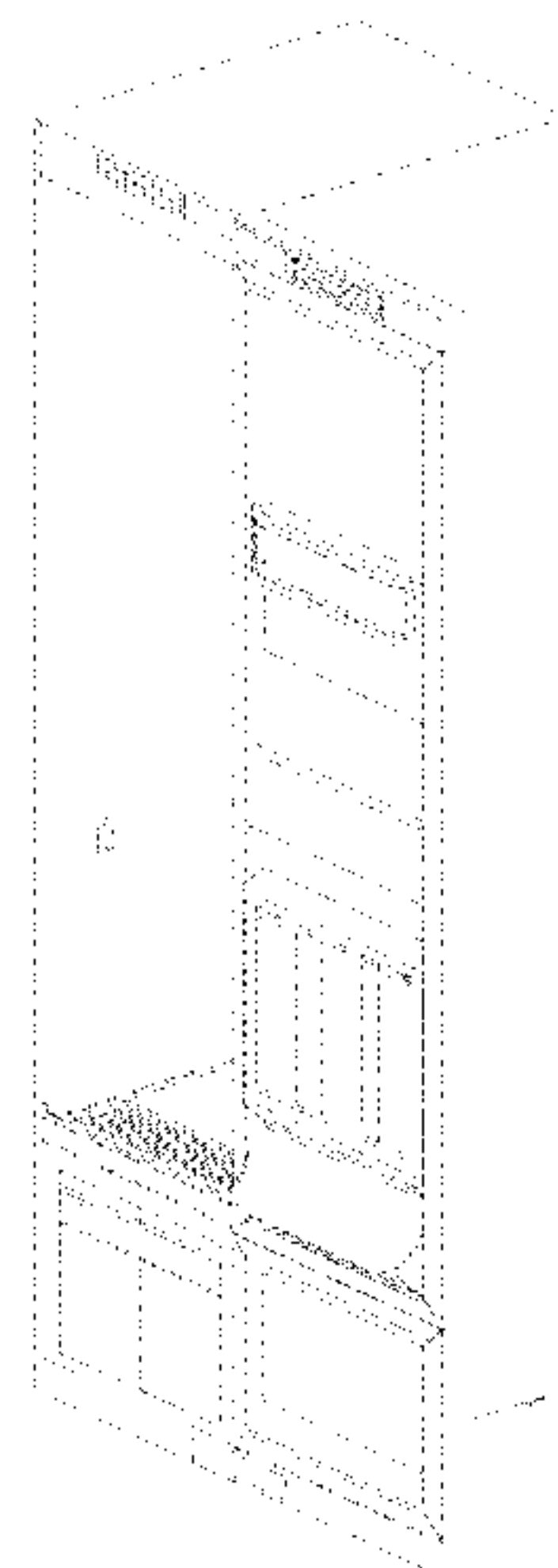

(58) **Field of Classification Search**

CPC ..... D06F 58/20; D06F 73/02; D06F 58/10;  
D06F 58/12; D06F 58/203

See application file for complete search history.

(56) **References Cited**

U.S. PATENT DOCUMENTS

D640,430	S *	6/2011	Jee	.....	D32/6
D643,165	S *	8/2011	Song	.....	D32/8
8,037,626	B2 *	10/2011	Moon	.....	D06F 58/10 38/14
D663,495	S *	7/2012	Song	.....	D32/8
8,215,133	B2 *	7/2012	Kim	.....	D06F 58/203 68/5 C
8,424,141	B2 *	4/2013	Yoo	.....	D06F 58/203 8/149.3
8,484,868	B2 *	7/2013	Kim	.....	D06F 58/12 38/14
8,505,340	B2 *	8/2013	Kim	.....	D06F 58/10 68/5 C
D732,769	S *	6/2015	Chung	.....	D32/25
D732,770	S *	6/2015	Choi	.....	D32/25
D732,771	S *	6/2015	Chung	.....	D32/25
D732,772	S *	6/2015	Chung	.....	D32/25
D732,773	S *	6/2015	Chung	.....	D32/25
D732,774	S *	6/2015	Chung	.....	D32/25
D732,775	S *	6/2015	Chung	.....	D32/25
D743,127	S *	11/2015	Chung	.....	D32/25
D743,128	S *	11/2015	Chung	.....	D32/25
D743,129	S *	11/2015	Chung	.....	D32/25
D743,130	S *	11/2015	Choi	.....	D32/25
D743,652	S *	11/2015	Chung	.....	D32/25

D743,653	S *	11/2015	Chung	.....	D32/25
D743,654	S *	11/2015	Chung	.....	D32/25
D824,124	S *	7/2018	Lee	.....	D32/6
D827,236	S *	8/2018	Chung	.....	D32/25
D828,656	S *	9/2018	Chung	.....	D32/6
D836,271	S *	12/2018	Chung	.....	D32/6
D839,515	S *	1/2019	Chung	.....	D32/25
D897,058	S *	9/2020	Kim	.....	D32/6
2001/0037590	A1 *	11/2001	MacGregor	.....	D06F 3/02 38/3
2008/0136295	A1 *	6/2008	Aizpuru Borda	.....	D06F 58/10 312/31
2010/0058813	A1 *	3/2010	Moon	.....	D06F 73/02 68/6
2012/0240425	A1 *	9/2012	Park	.....	D06F 58/20 34/202

FOREIGN PATENT DOCUMENTS

KR	30-2013-0046969	6/2014
KR	30-2013-0046963	8/2014
KR	30-2014-0001615	2/2015
KR	30-2015-0047007	1/2016

OTHER PUBLICATIONS

NST GreenGuard, “[Coway] 2018 CES Standing rental rental product ‘Clothing cleaner FWSS’”, [2018], Apr. 6, 2018, <<http://blog.naver.com>>, <http://blog.naver.com/miron333/221246764331>.  
Kim Seunggho, “Pakeco Produce Clothes Dryer Samsung Electronics Trademark Release”, [2010], May 5, 2010, <[news.v.daum.net](http://news.v.daum.net)>, <http://v.media.daum.net/v/20100516172017689>.

\* cited by examiner

FIG. 1

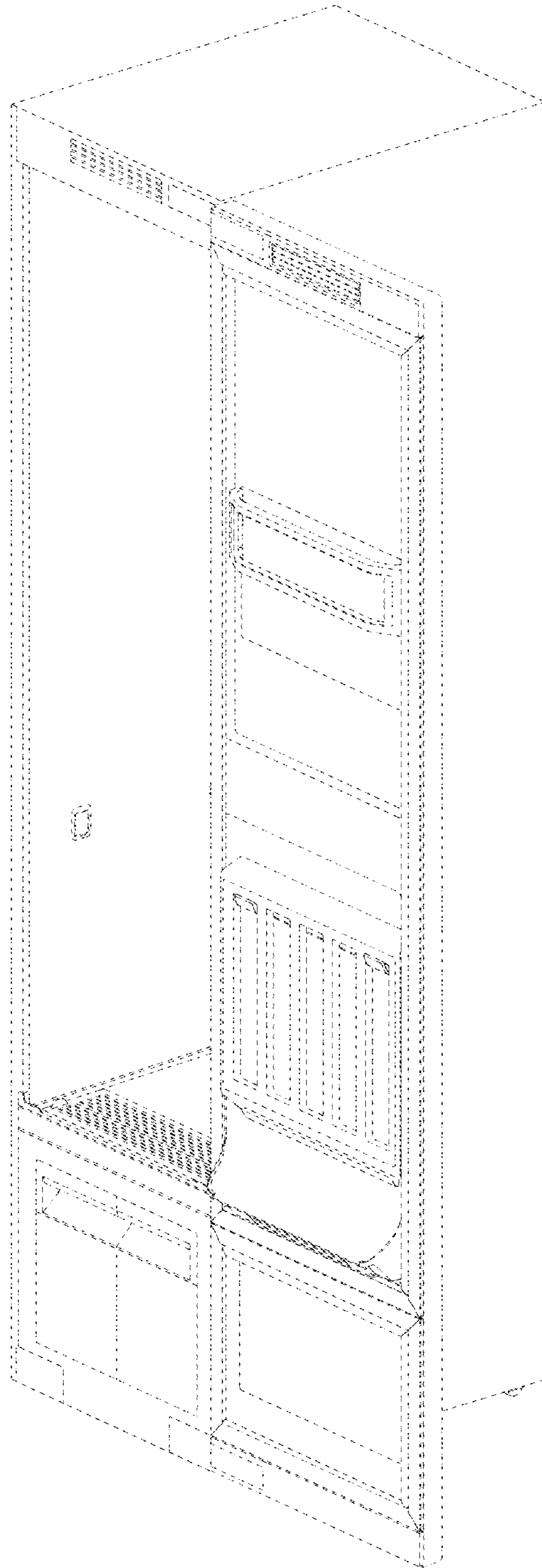



FIG. 2

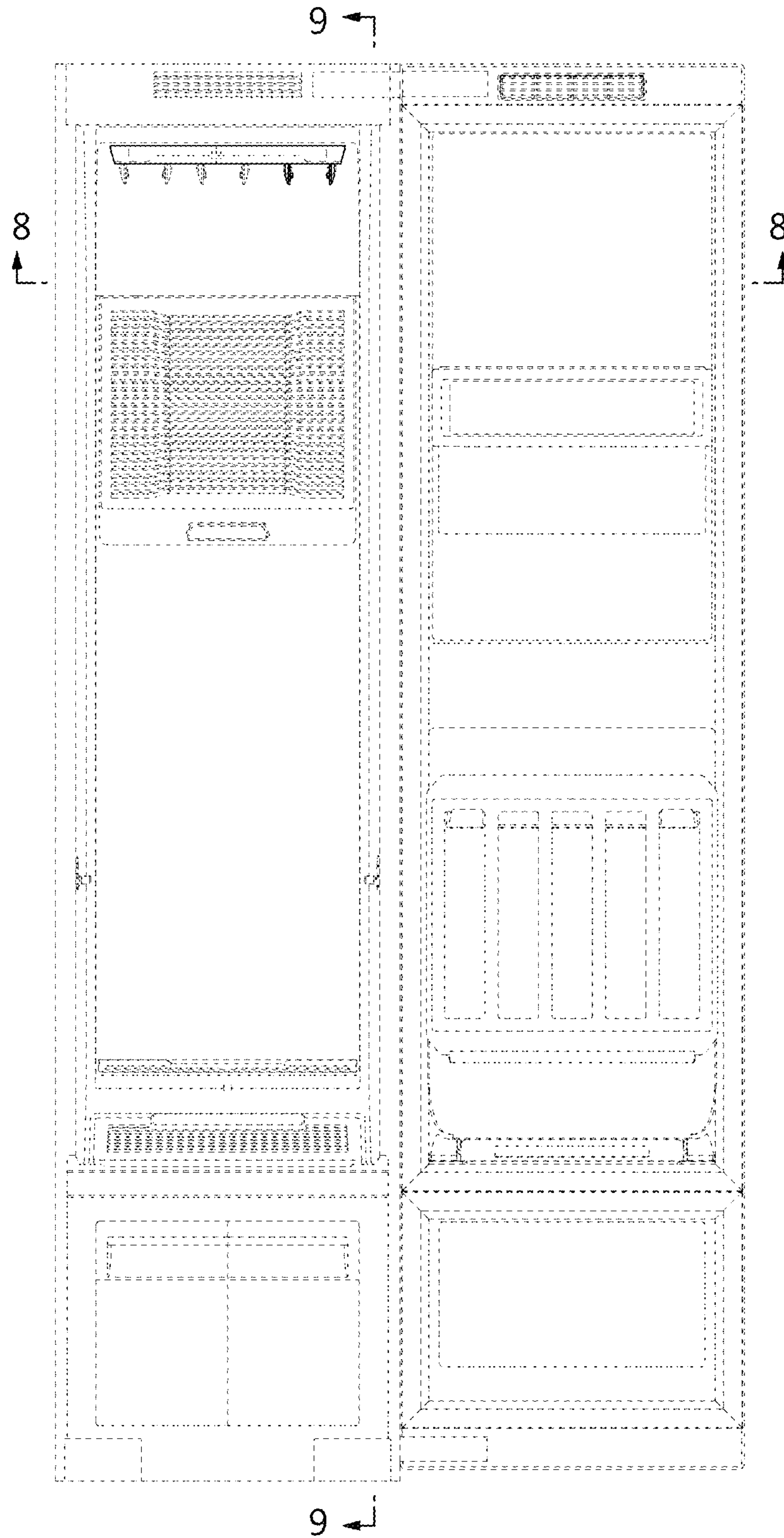

FIG. 3



FIG. 4

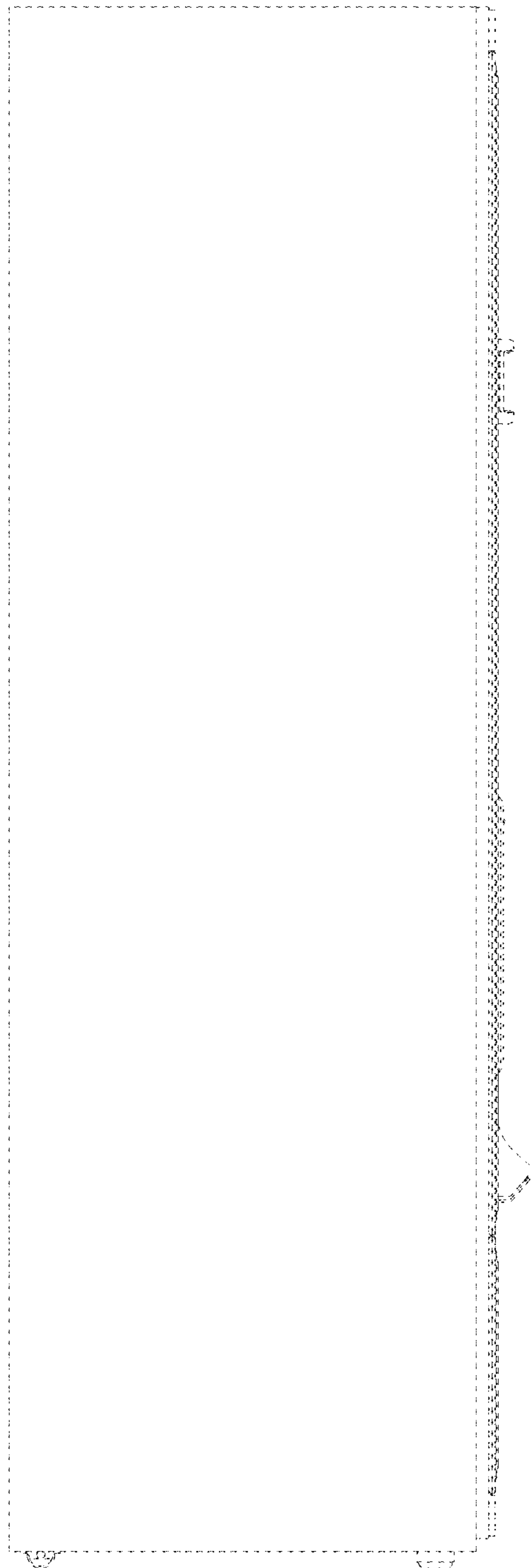

FIG. 5

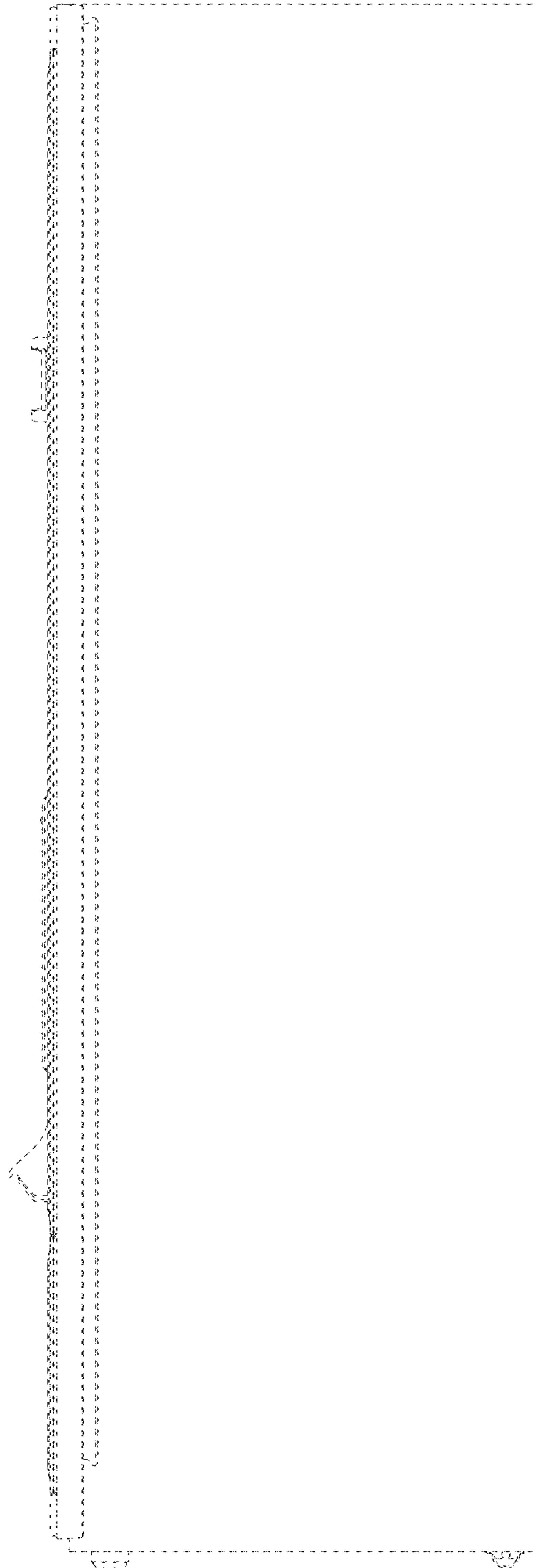

FIG. 6

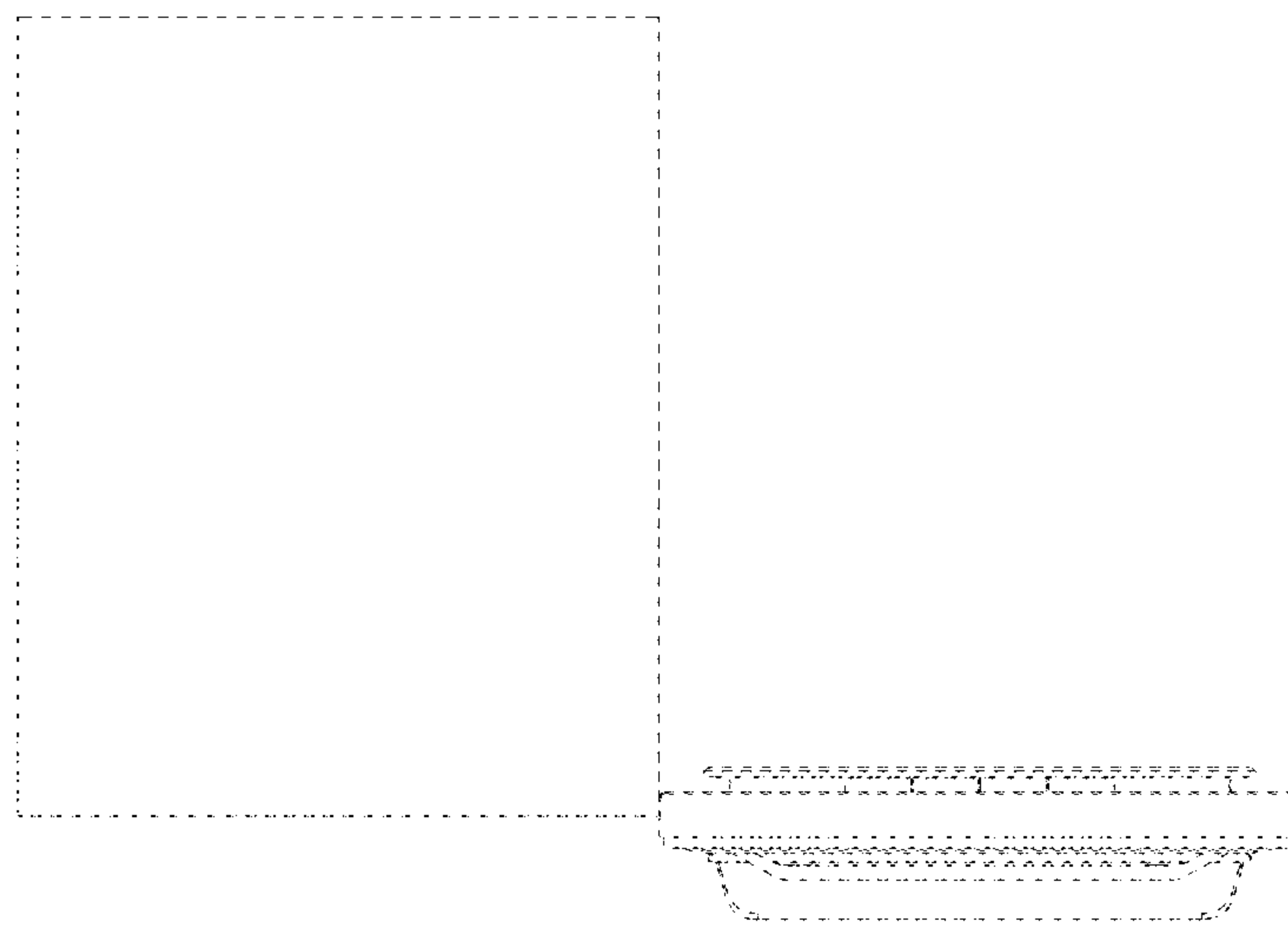



FIG. 7

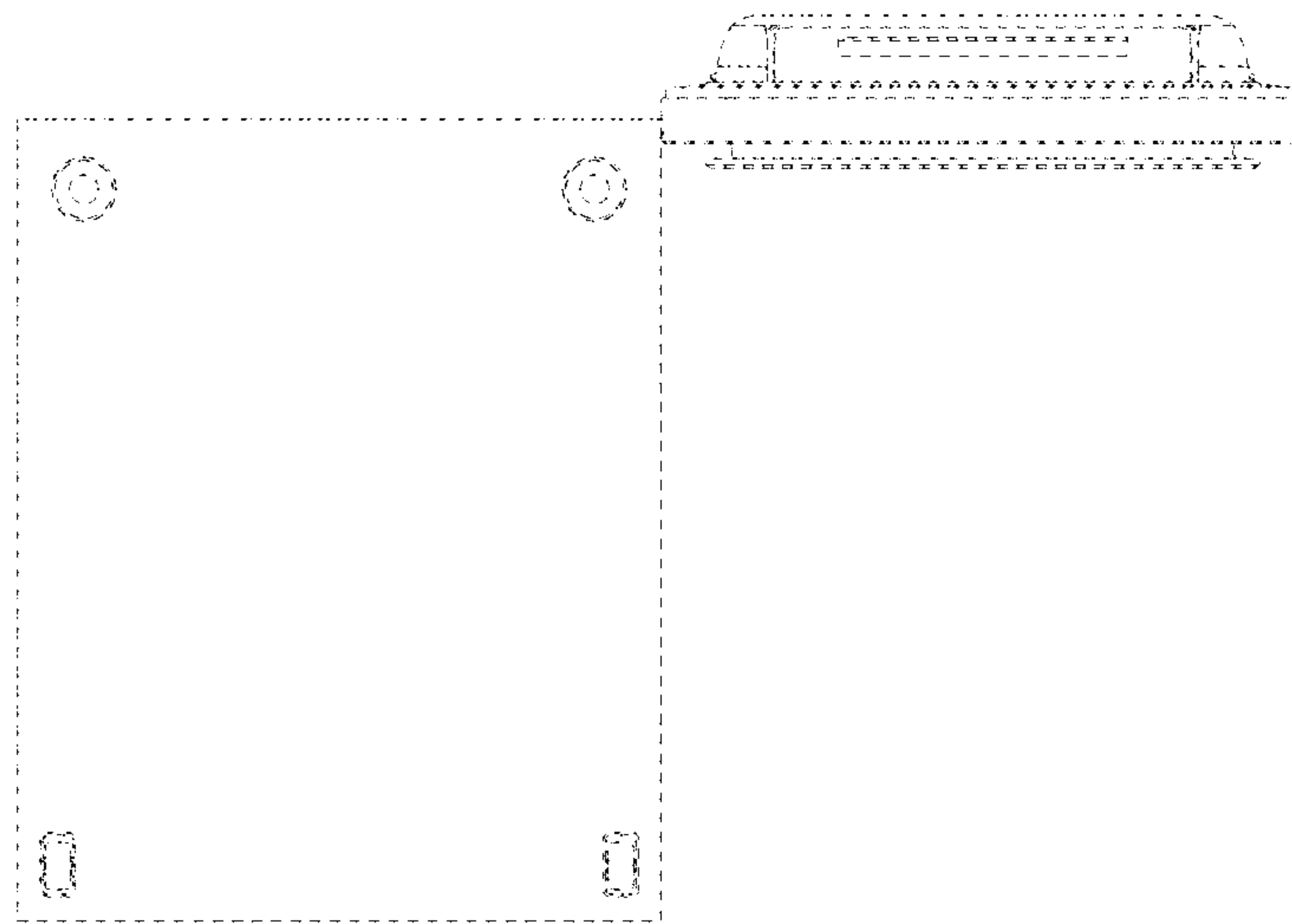

FIG. 8

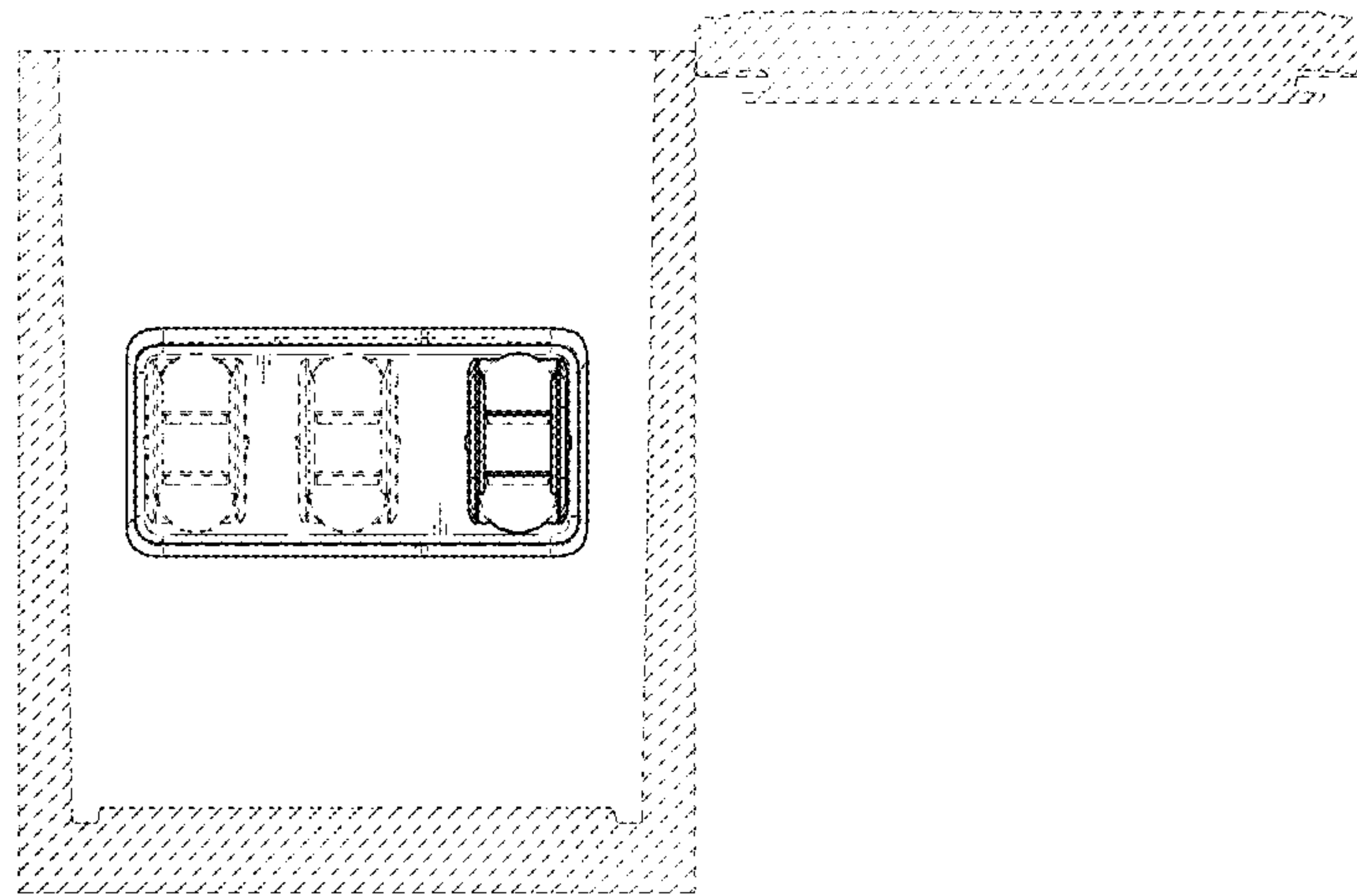

FIG. 9

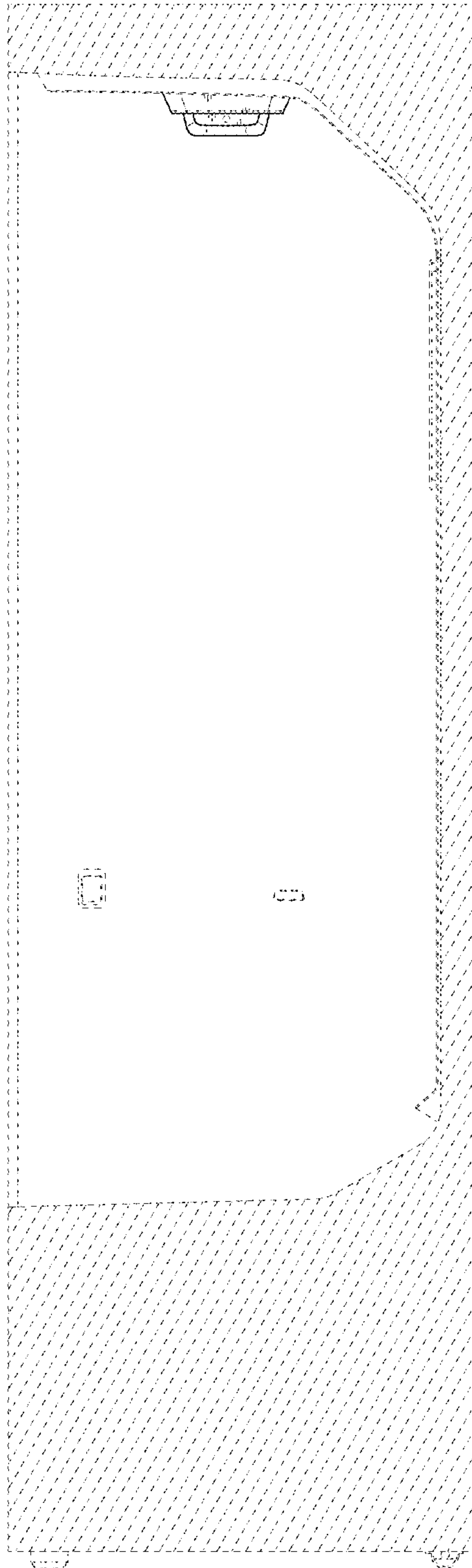

FIG. 10

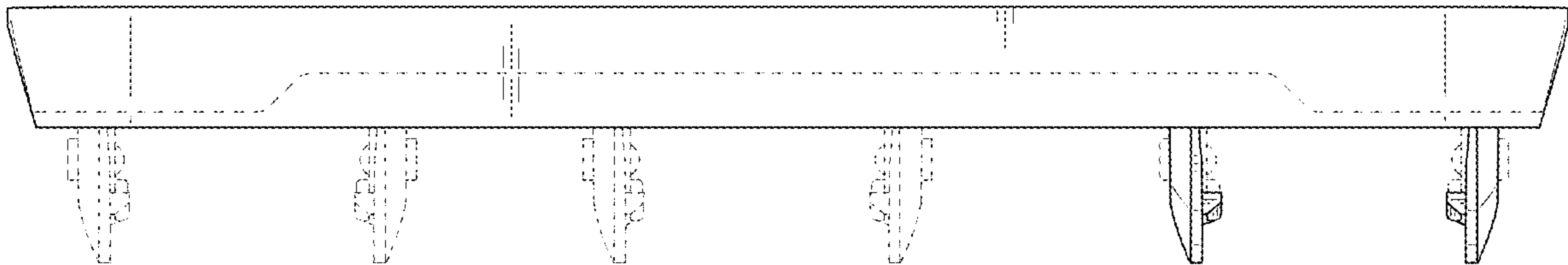

FIG. 11

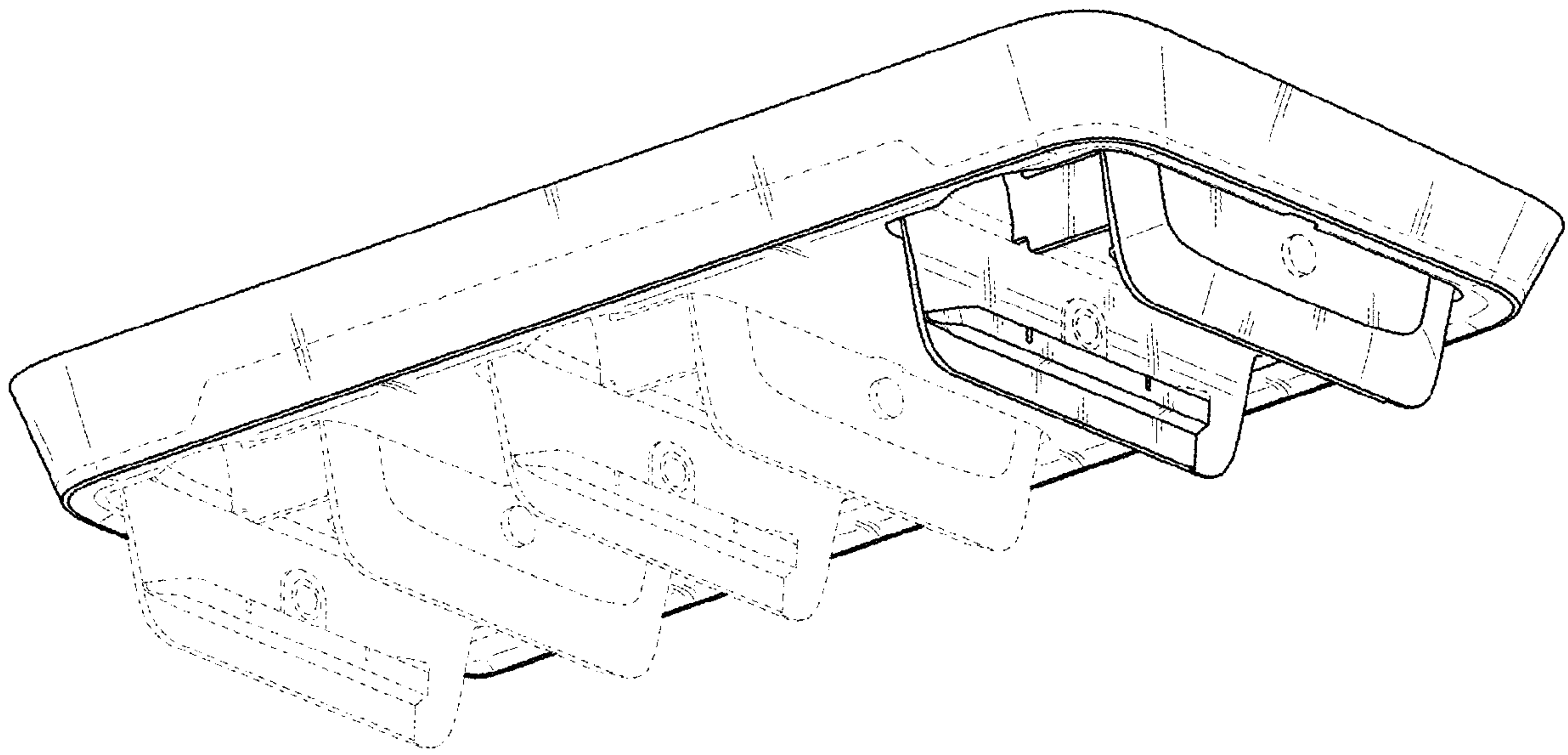

FIG. 12

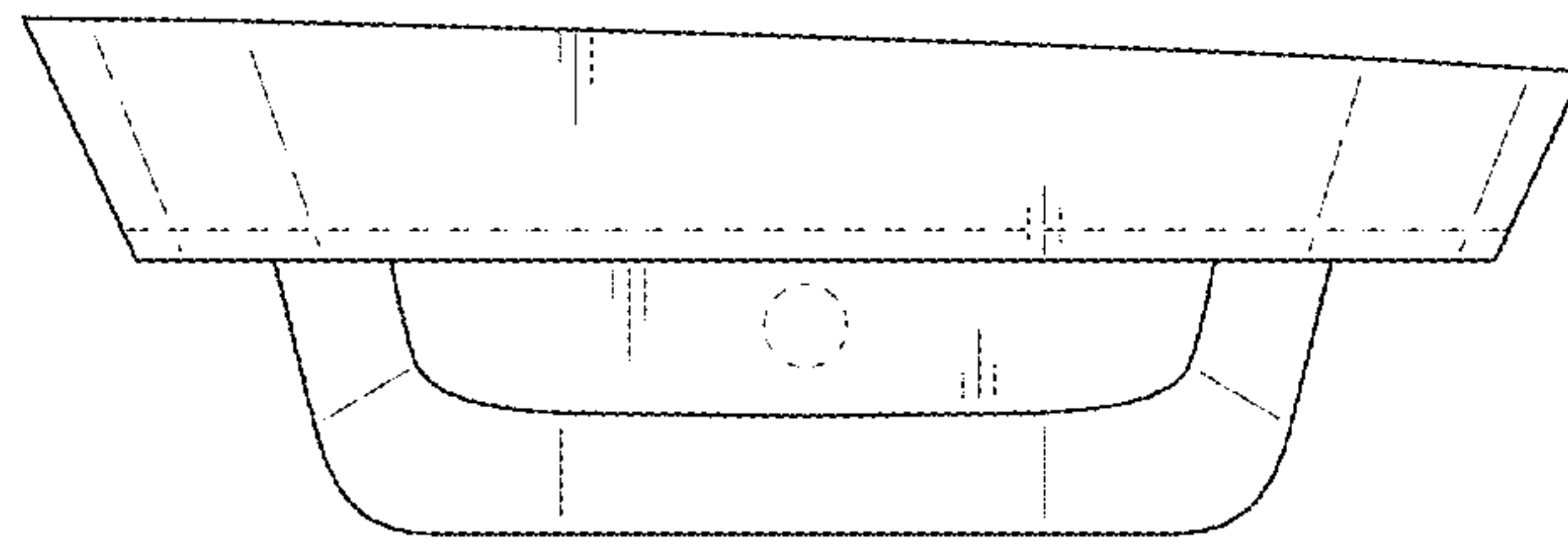



FIG. 13

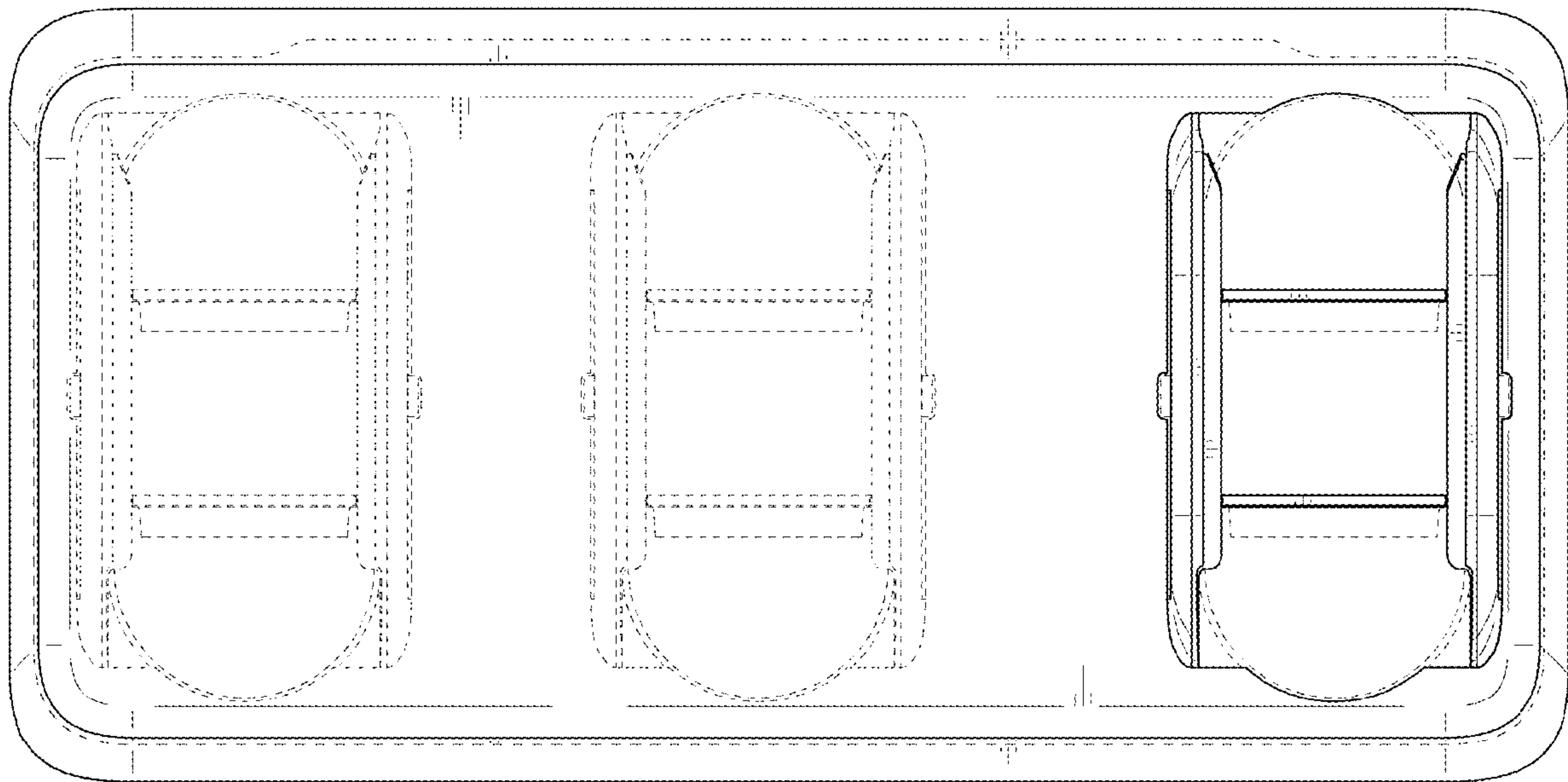

FIG. 14

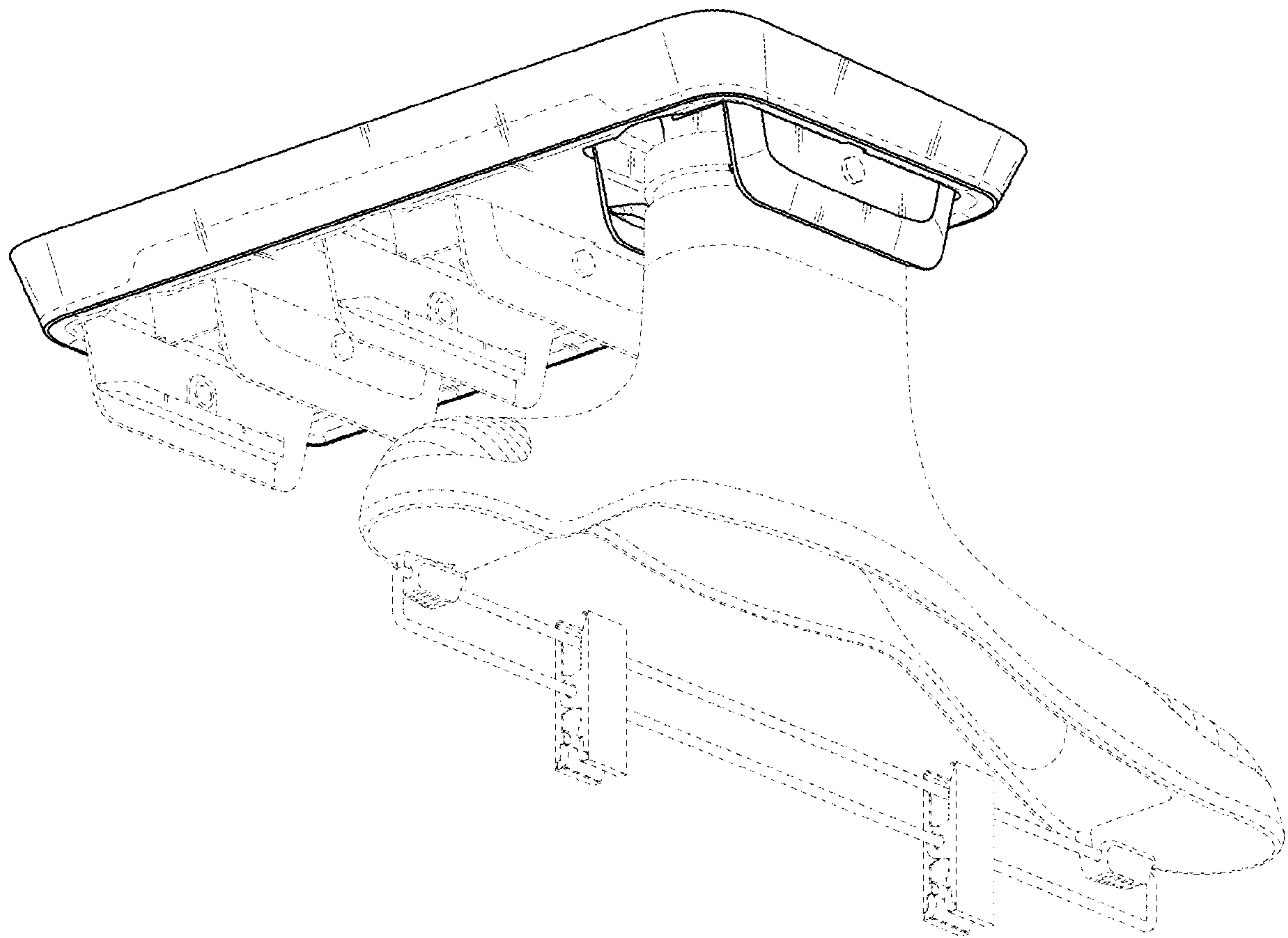

FIG. 15

