

US00D909689S

(12) **United States Design Patent** (10) **Patent No.:** **US D909,689 S**
Xu (45) **Date of Patent:** **** Feb. 2, 2021**

(54) **PET NAIL GRINDER**

(71) Applicant: **Wuhan canyiXunJie trading co., ltd,**
Wuhan (CN)

(72) Inventor: **Wanqing Xu,** Putian (CN)

(**) Term: **15 Years**

(21) Appl. No.: **29/751,067**

(22) Filed: **Sep. 18, 2020**

(51) **LOC (13) Cl.** **30-99**

(52) **U.S. Cl.**

USPC **D30/158**

(58) **Field of Classification Search**

USPC D30/158, 199; 119/600, 468, 607-611,
119/627, 633, 663, 601; D28/59, 36, 58,
D28/44, 49, 50, 53, 85, 44.1, 51, 63;
D8/61, 62, 82, DIG. 7; D24/147, 146,
D24/214, 215, 200, 111, 133, 144, 156,
D24/186; D4/100-102, 137, 119, 120;
132/73.6, 75.8, 76.4, 73.5, 75.3, 75.6,
132/118, 119.1, 75.4, 75.5, 75; 30/26,
30/29.5, 43, 43.4-43.6, 41.5, 206, 133,
30/276, 29, 277.4, 240, 210, 43.92, 392,
30/167, 329, 169; 15/23, 28, 22.1, 101,
15/65, 104.04, 88, 104.095, 97.1, 179;
451/356, 162-164; 452/98; 81/3.42,
81/177.7, 57.26, 57.11, 58.3; 606/85,
606/131; 83/698.11, 520; 362/120;
206/368; 392/380, 384; 173/29, 217,
173/216; 310/50; 464/53; 601/70;
D15/132; 433/133, 130, 125, 127, 166,
433/126, 132; 279/51, 147; D26/49, 37;
D9/723, 529, 530, 548

CPC A01K 13/00; A01K 13/001; A45D 29/05;
A45D 29/06; A45D 29/11; A45D 29/14;
A45D 29/00

See application file for complete search history.

(56) **References Cited**

U.S. PATENT DOCUMENTS

3,613,696	A *	10/1971	Paule	A45D 29/14 132/73.6
D249,565	S *	9/1978	Levin	D28/58
D253,675	S *	12/1979	Rakocy	D28/58
D256,171	S *	7/1980	Tomaro	D28/50
D264,679	S *	6/1982	Funkhouser	D19/901
D266,111	S *	9/1982	Doyel	D28/58
D295,601	S *	5/1988	Svetlik	D8/61
4,848,946	A *	7/1989	Goncalves	A46B 7/02 401/131
D303,205	S *	9/1989	Gierke	D8/61
D304,543	S *	11/1989	Somers	D8/61
D305,806	S *	1/1990	Fujisawa	D28/50
D308,622	S *	6/1990	Fushiya	D8/30
D316,216	S *	4/1991	Gierke	D8/61
D319,711	S *	9/1991	Fujisawa	D28/50

(Continued)

Primary Examiner — Susan Moon Lee

(74) *Attorney, Agent, or Firm* — HYIP

(57) **CLAIM**

The ornamental design for a pet nail grinder, as shown and described.

DESCRIPTION

FIG. 1 is a perspective view of a pet nail grinder showing my new design;
FIG. 2 is a front view thereof;
FIG. 3 is a back view thereof;
FIG. 4 is a left side view thereof;
FIG. 5 is a right side view thereof;
FIG. 6 is a top view thereof;
FIG. 7 is a bottom view thereof; and,
FIG. 8 is a perspective view of another state of the pet nail grinder thereof.
The broken lines shown in the drawings depict portions of the pet nail grinder in which the design is embodied that form no part of the claimed design.

1 Claim, 8 Drawing Sheets

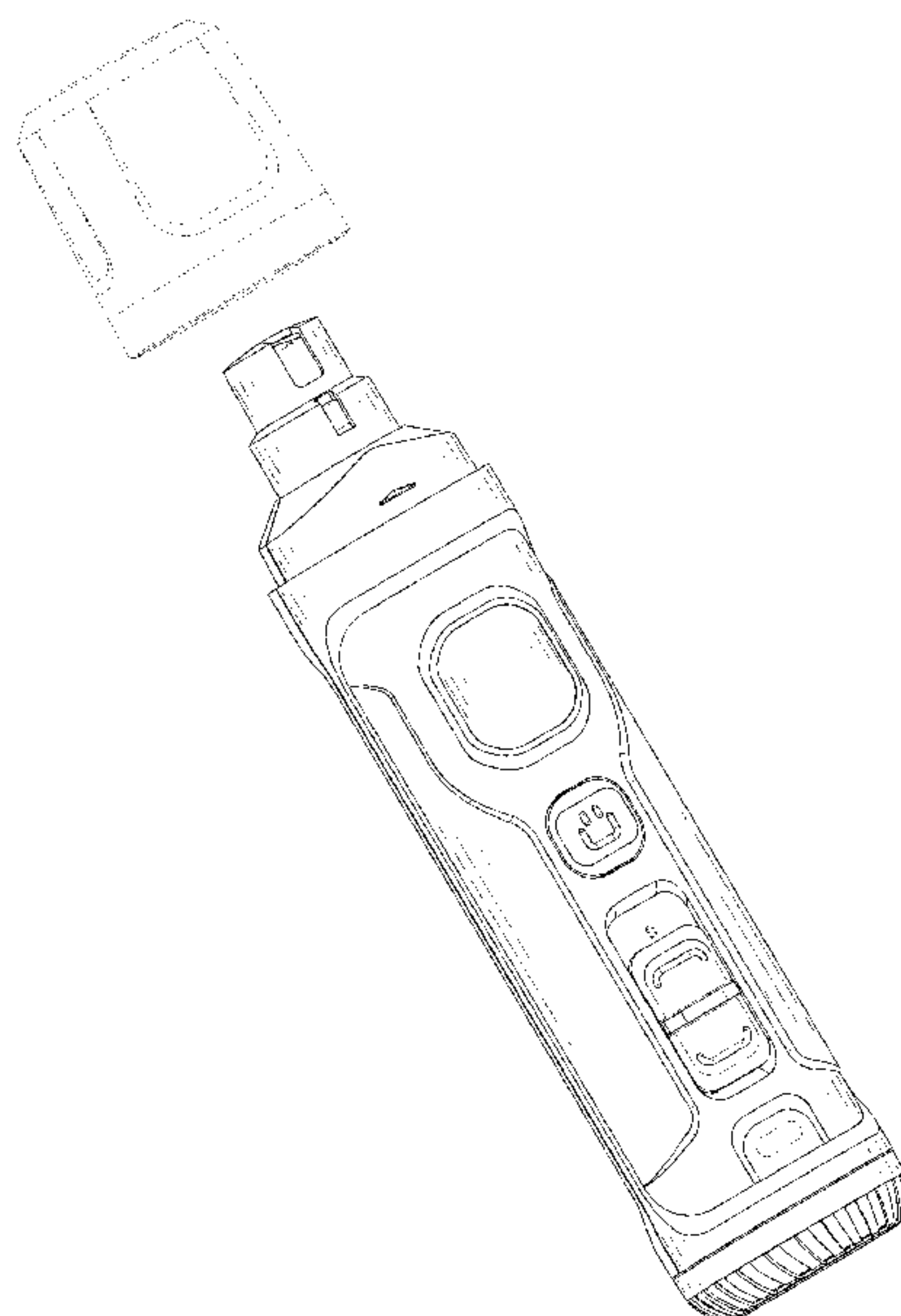

US D909,689 S

(56)

References Cited

U.S. PATENT DOCUMENTS

D320,727 S *	10/1991	Fushiya	D8/62	8,894,312 B2 *	11/2014	Toh	A45D 34/041
D323,274 S *	1/1992	Sasaki	D8/61				401/209
D325,503 S *	4/1992	Kikuchi	D8/61	8,894,313 B2 *	11/2014	Toh	A45D 34/041
5,123,430 A *	6/1992	Davidovitz	A45D 29/02				401/209
			132/73.6	D724,726 S *	3/2015	Prokop	D24/133
D330,091 S *	10/1992	Anema	D28/58	D736,999 S *	8/2015	Yiu	D28/58
5,251,706 A *	10/1993	Evans	B25B 13/46	D747,464 S *	1/2016	Taylor	A61C 17/0202
			173/217				D24/111
D343,561 S *	1/1994	McCambridge	D8/61	D748,784 S *	2/2016	Weitkamp	D24/133
D347,283 S *	5/1994	Von Winckler	D24/200	D756,034 S *	5/2016	Yiu	D28/58
5,310,010 A *	5/1994	Lo	B23P 19/065	D766,508 S *	9/2016	Wang	D28/58
			173/178	D768,334 S *	10/2016	Langberg	D28/58
D368,984 S *	4/1996	Nakashima	D28/53	D768,931 S *	10/2016	Langberg	D28/58
5,525,889 A *	6/1996	Chan	B25B 21/00	D768,932 S *	10/2016	Langberg	D28/58
			173/217	D769,529 S *	10/2016	Langberg	D28/58
D376,048 S *	12/1996	Gerhart	D4/114	D778,433 S *	2/2017	Li	D24/111
D380,658 S *	7/1997	Bruno	D24/146	D781,496 S *	3/2017	Butler	D28/58
D391,820 S *	3/1998	Bunyea	D8/61	D786,643 S *	5/2017	Valentini	D8/62
D418,729 S *	1/2000	Snider	D8/61	D787,083 S *	5/2017	Ely	D24/209
D423,897 S *	5/2000	Cooper	D8/61	D788,980 S *	6/2017	Yiu	D28/58
6,067,714 A *	5/2000	Taylor	B26B 19/148	D788,982 S *	6/2017	Yiu	D28/58
			30/29.5	D788,983 S *	6/2017	Yiu	D28/62
6,102,134 A *	8/2000	Alsrue	B25F 5/02	D828,925 S *	9/2018	Levi	D24/214
			173/170	10,070,624 B2 *	9/2018	Davis	B25F 5/02
D434,181 S *	11/2000	Watanabe	D28/9	D842,987 S *	3/2019	Theobald	D24/133
6,257,351 B1 *	7/2001	Ark	A61B 17/1626	D843,800 S *	3/2019	Jiang	D8/61
			173/178	D846,738 S *	4/2019	Kalina, Jr.	D24/133
D452,589 S *	12/2001	Lie	D28/58	D847,333 S *	4/2019	Theobald	D24/133
D458,679 S *	6/2002	Thompson	D24/133	D847,360 S *	4/2019	Levi	D24/214
D462,896 S *	9/2002	Crawford	D9/693	D850,638 S *	6/2019	Cha	D24/200
D466,776 S *	12/2002	Hsiao	D8/62	D854,257 S	7/2019	Hollinger	
D467,146 S *	12/2002	Chunn	D8/61	D860,470 S *	9/2019	Li	D24/214
D470,374 S *	2/2003	Murray	D8/61	D861,864 S *	10/2019	Amano	D24/133
6,523,546 B2 *	2/2003	Jo	A61B 17/54	D866,336 S *	11/2019	Ramsuer	D9/516
			132/75.8	D876,730 S	2/2020	He	
D472,779 S *	4/2003	Chunn	D8/61	D895,210 S	9/2020	Wu	
D472,969 S *	4/2003	Wilden	D24/133	2003/0102002 A1 *	6/2003	Cho	A45D 29/05
D476,444 S *	6/2003	Hara	D28/50				132/73.6
6,640,811 B2 *	11/2003	Cho	A45D 29/05	2004/0074025 A1 *	4/2004	Blaustein	B25F 3/00
			132/73.6				15/23
D489,151 S *	4/2004	Krieger	D32/15	2005/0169693 A1 *	8/2005	Serio	B05C 17/0357
D503,495 S *	3/2005	Maeda	D28/53				401/219
D508,414 S *	8/2005	Lamb	D9/504	2006/0150992 A1 *	7/2006	Nevakshonoff	B24B 23/02
D510,158 S *	9/2005	Cheung	D24/147				132/73.6
7,152,323 B1 *	12/2006	Lin	B26B 19/148	2006/0289025 A1 *	12/2006	Nevakshonoff	B24B 23/02
			30/29.5				132/73.6
D549,327 S *	8/2007	Aparici	D24/133	2007/0186867 A1 *	8/2007	Mulloy	A01K 13/00
D551,044 S *	9/2007	Mochida	D8/61				119/601
D565,916 S *	4/2008	Chen	D8/61	2008/0099032 A1 *	5/2008	Jackson	A45D 29/05
D568,473 S *	5/2008	Ashiwa	D24/133				132/200
D575,003 S *	8/2008	Lineberger	D28/58	2008/0255586 A1 *	10/2008	Greenberg	A61B 17/54
D585,987 S *	2/2009	Aparici	D24/133				606/131
D592,527 S *	5/2009	Serio	D9/529	2010/0000557 A1 *	1/2010	Keene	A45D 29/14
D592,746 S *	5/2009	Highley	D24/133				132/73.6
D596,357 S *	7/2009	Rosen	D30/158	2011/0226268 A1 *	9/2011	Filonczuk	A45D 29/05
D600,413 S *	9/2009	Khubani	D30/158				132/73.6
D601,873 S *	10/2009	Lau	D8/62	2011/0226270 A1 *	9/2011	Rivera	A45D 29/05
D611,824 S *	3/2010	Akkermans	D9/529				132/73.6
D619,707 S *	7/2010	East	A61B 17/4241	2015/0051620 A1 *	2/2015	Presser	A61B 17/54
			D24/133				606/131
8,011,521 B2 *	9/2011	Clark	B65D 23/102	2015/0150352 A1 *	6/2015	Yiu	A61B 17/54
			215/11.1				132/75.8
D678,080 S *	3/2013	van Haasteren	D9/725	2015/0150353 A1 *	6/2015	Yiu	A45D 29/14
8,469,039 B2 *	6/2013	Jackson	A45D 29/05				132/75.6
			132/200	2015/0173484 A1 *	6/2015	Fitzsimons	A45D 29/02
D686,510 S *	7/2013	Zerba	D9/726				132/200
D698,248 S *	1/2014	Lambrecht	D9/522	2016/0029768 A1 *	2/2016	Dai	A45D 29/02
D711,714 S *	8/2014	Sawaya	D8/61				30/27
				2020/0260689 A1 *	8/2020	Jacobowitz	A01K 13/00

* cited by examiner

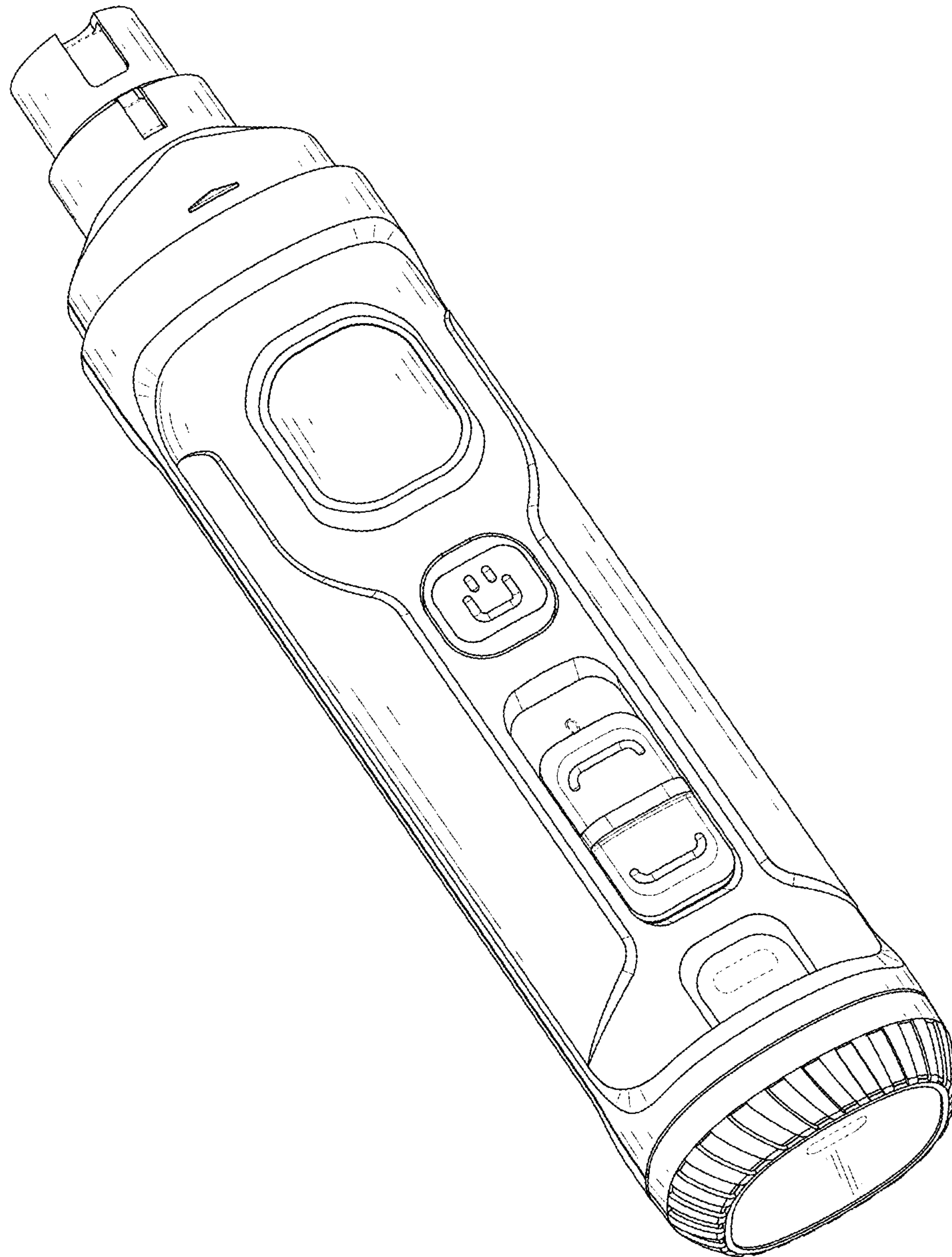

FIG. 1

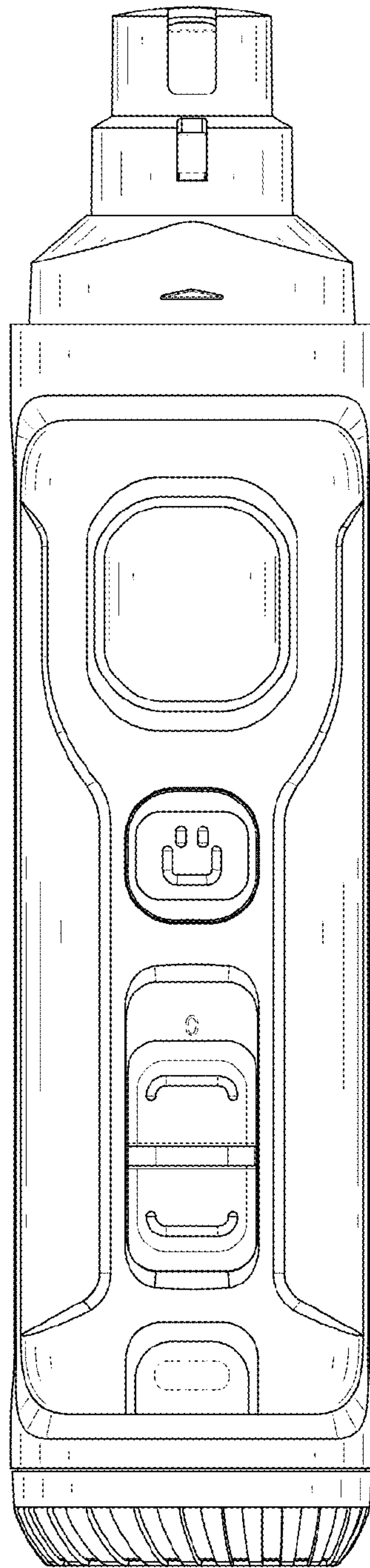

FIG. 2

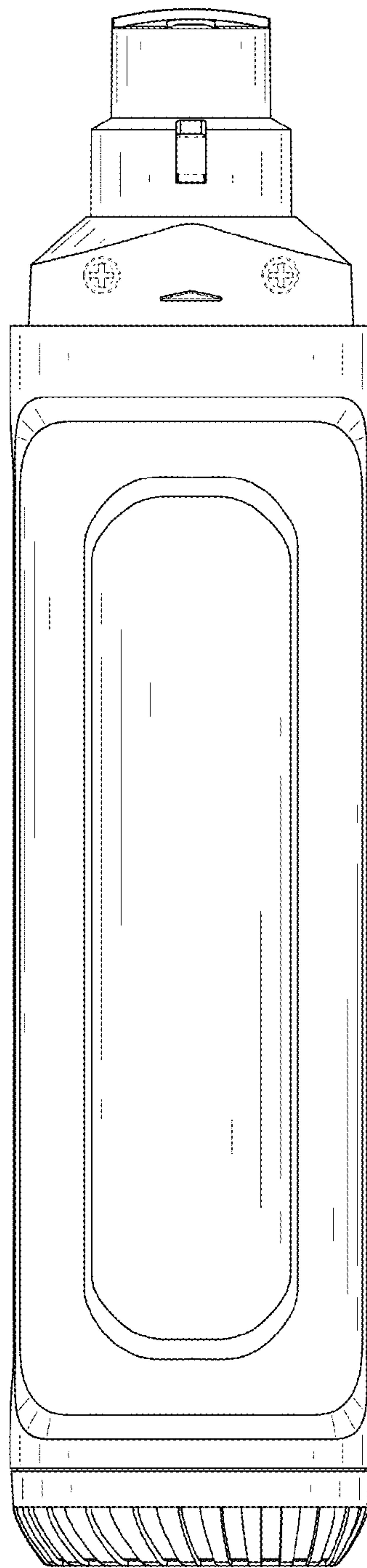

FIG. 3

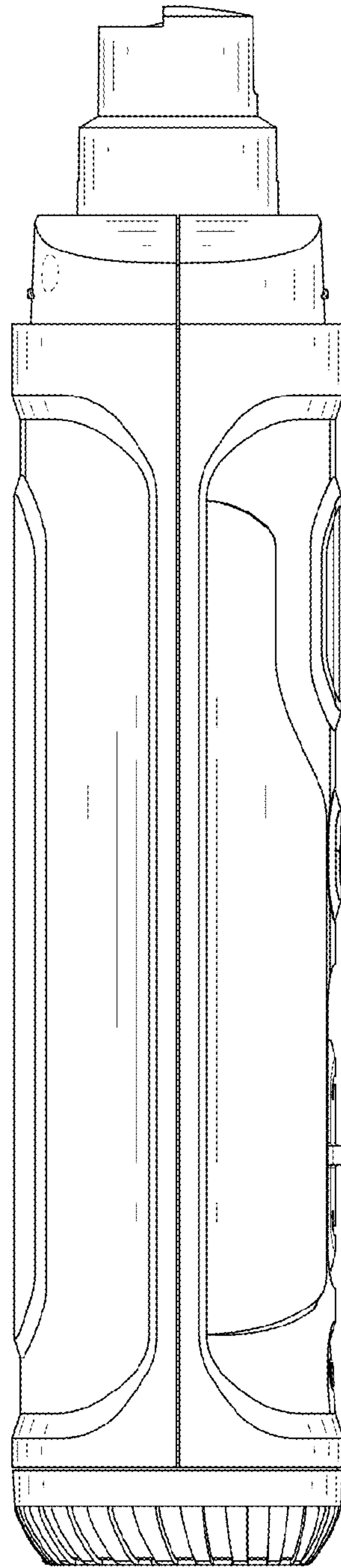

FIG. 4

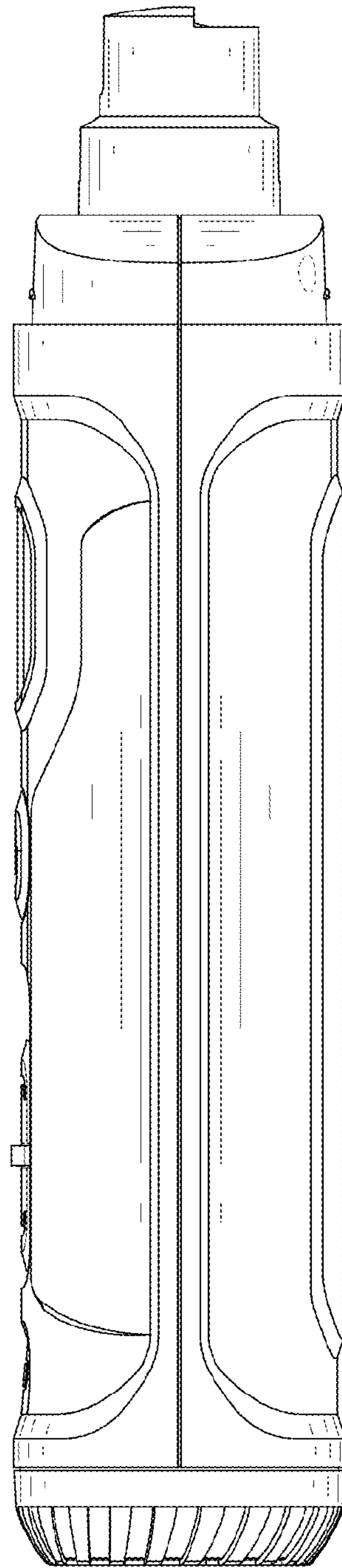

FIG. 5

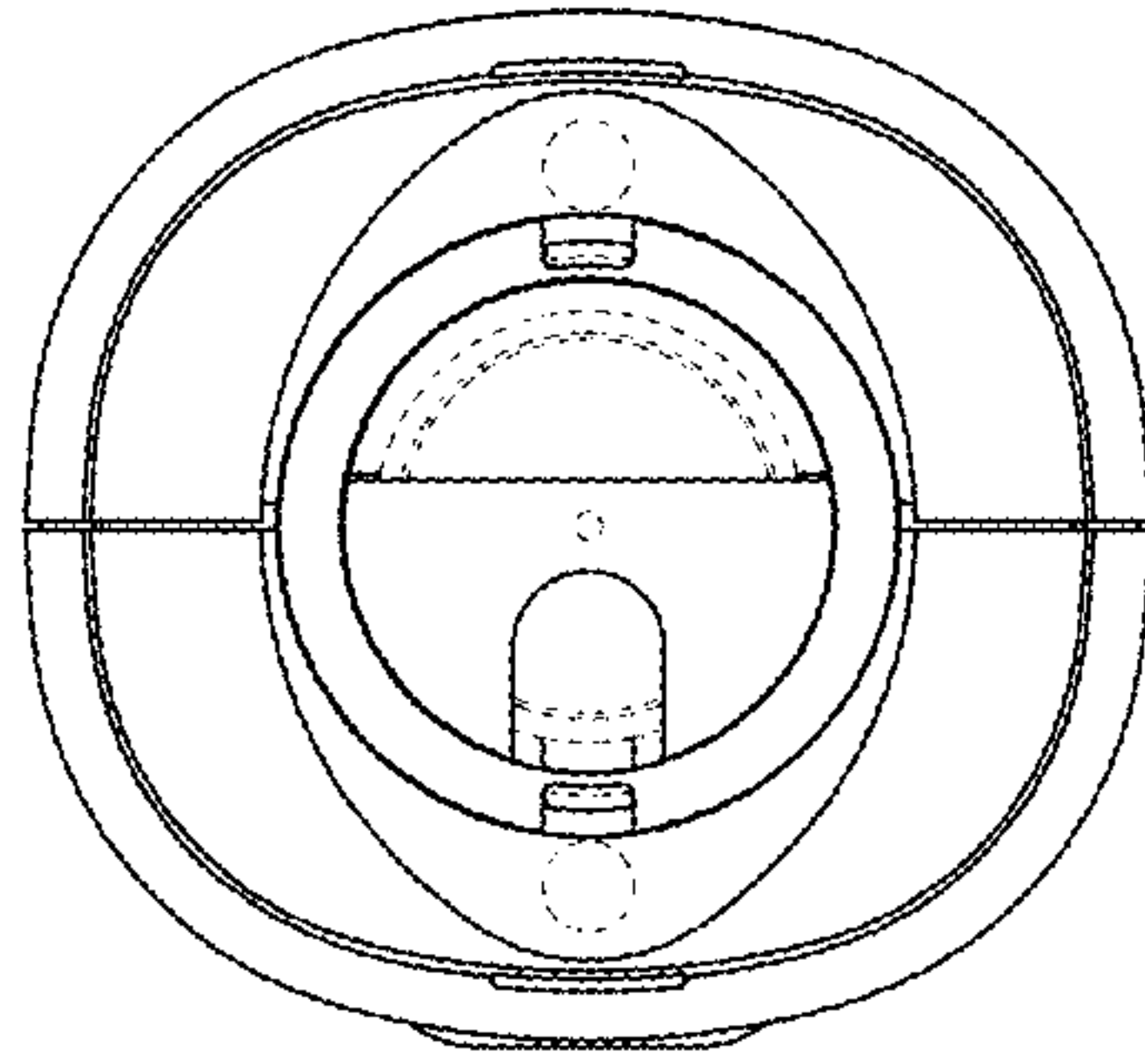

FIG. 6

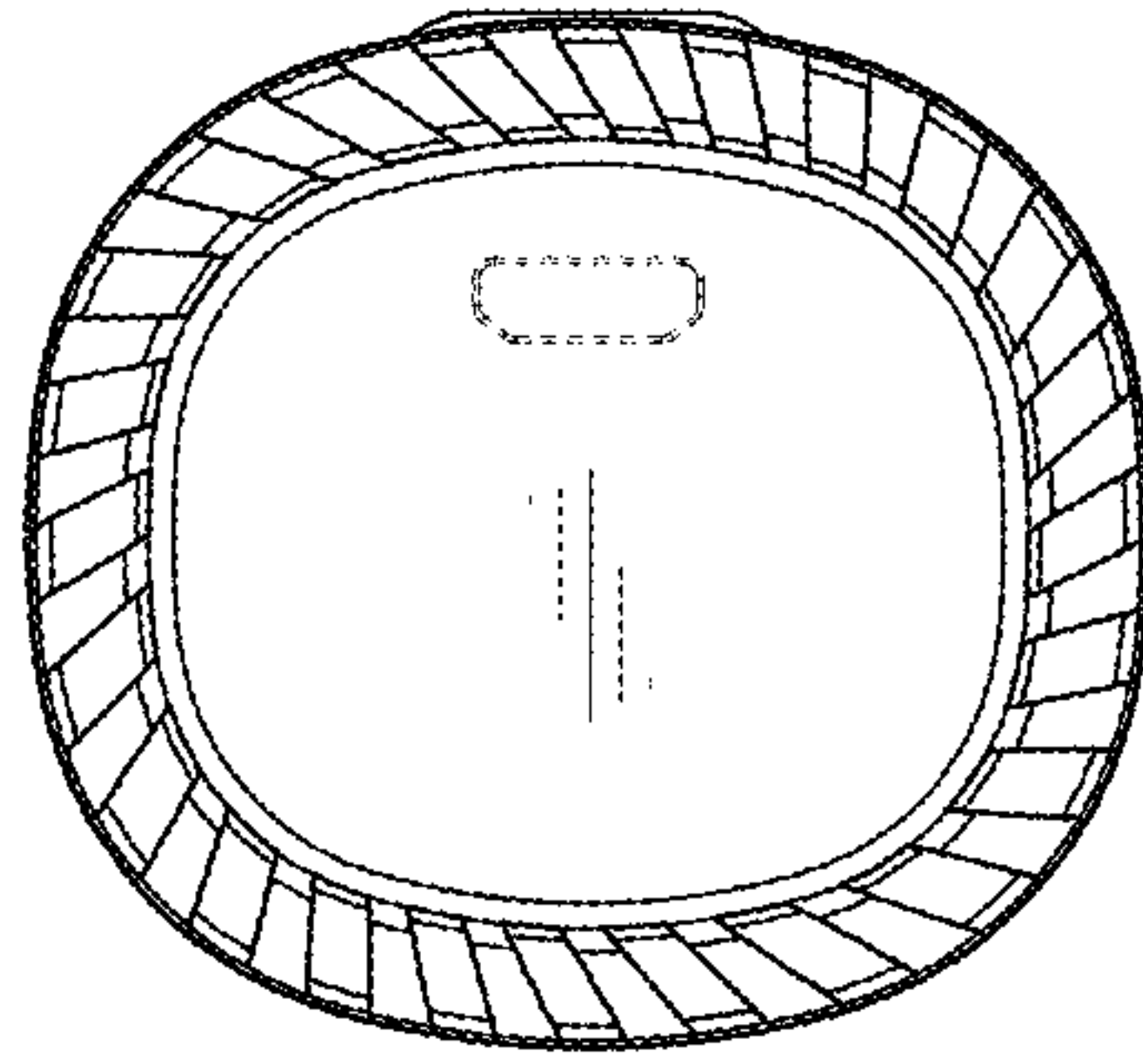

FIG. 7

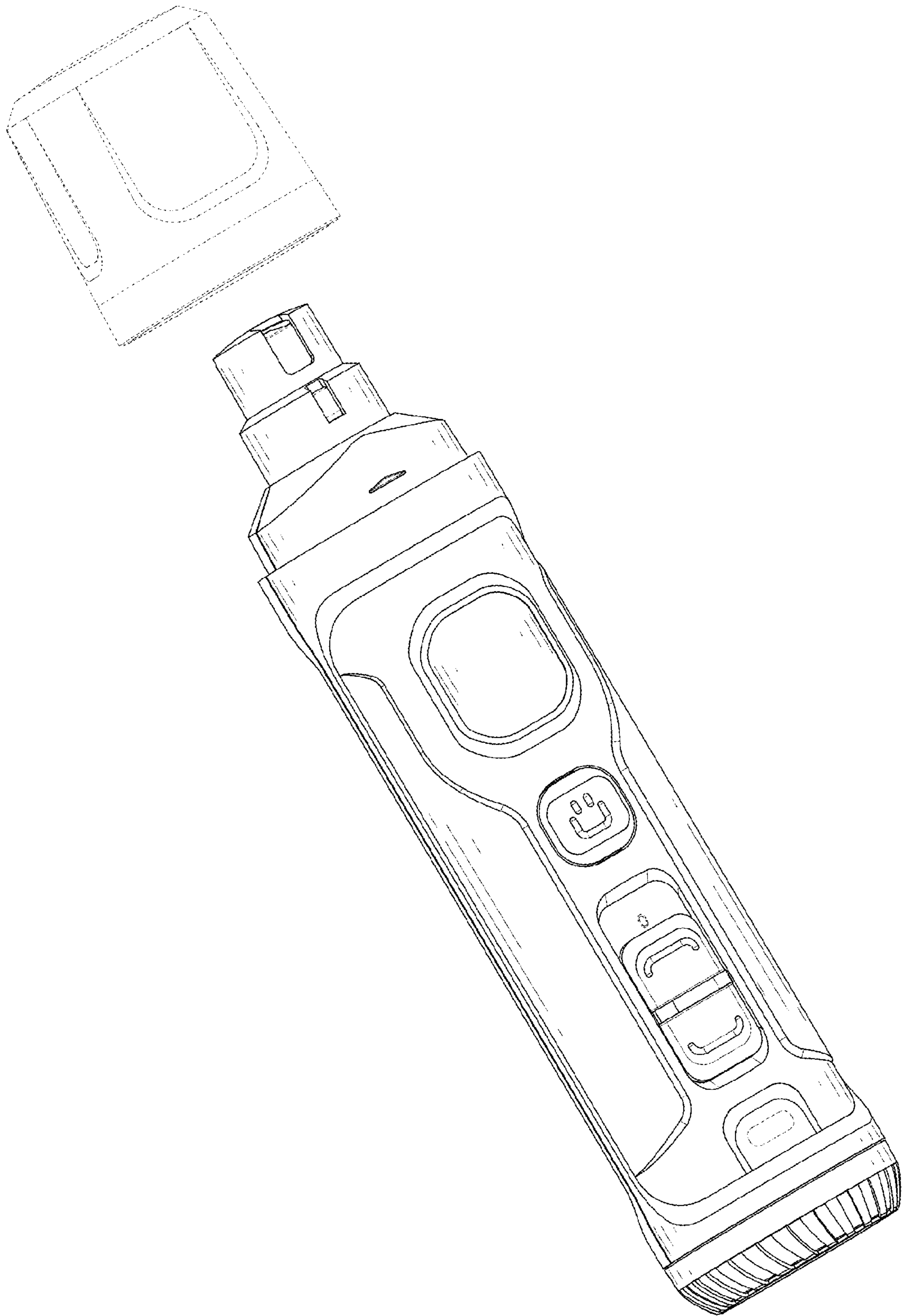

FIG. 8