



US00D909687S

(12) **United States Design Patent**
Hamoignon

(10) **Patent No.:** **US D909,687 S**

(45) **Date of Patent:** **** Feb. 2, 2021**

(54) **STIRRUP**

(71) Applicant: **DECATHLON**, Villeneuve d'Ascq (FR)

(72) Inventor: **Nicolas Hamoignon**, Lille (FR)

(73) Assignee: **Decathlon**, Villeneuve d'Ascq (FR)

(**) Term: **15 Years**

(21) Appl. No.: **29/703,985**

(22) Filed: **Aug. 30, 2019**

(30) **Foreign Application Priority Data**

Mar. 4, 2019 (EM) 006277596-0001

(51) **LOC (13) Cl.** **30-04**

(52) **U.S. Cl.**
USPC **D30/142**

(58) **Field of Classification Search**
USPC D30/134, 135, 142
CPC B68C 3/00; B68C 1/16; B68C 3/02; B68C
2003/0041; B68C 2003/0091; B68C
2003/0083; B68C 2003/0025; B68C
2003/0058; B68C 3/025; B68C
2003/0008; B68C 2003/0066; B68C
2003/005

See application file for complete search history.

(56) **References Cited**

U.S. PATENT DOCUMENTS

D568,549 S * 5/2008 Augsten D30/142
D820,537 S * 6/2018 Barea D30/142
D866,090 S 11/2019 Lee
2009/0260336 A1 * 10/2009 Gottlieb B68C 3/02
54/71
2020/0156928 A1 * 5/2020 Molini B68C 3/0016

OTHER PUBLICATIONS

Images of Samshield Shield'Rup captured from <http://www.samshield.com/en/collection/shieldrup> published at least earlier than 2018.

Images of Freejump Soft'Up Classic captured from <https://www.freejumpsystem.com/en/produit/softup-classic> published at least earlier than 2010—Admitted prior art.

Images of Samshield Shield'Rup captured from <http://www.samshield.com/en/collection/shieldrup> published at least earlier than 2018—Admitted prior art.

Images of Look Rid'Up Stirrups captured from <https://www.rid-up.com/en/products/products-plus> published at least earlier than 2016—Admitted prior art.

* cited by examiner

Primary Examiner — Jennifer L Watkins

(74) *Attorney, Agent, or Firm* — Fross Zelnick Lehrman & Zissu, P.C.; Charles T. J. Weigell, Esq.

(57) **CLAIM**

The ornamental design for a stirrup, as shown and described.

DESCRIPTION

FIG. 1 is a front perspective view of a stirrup showing my new design;

FIG. 2 is a front view thereof;

FIG. 3 is a back side view thereof;

FIG. 4 is a left side view thereof;

FIG. 5 is a right side view thereof;

FIG. 6 is a top view thereof; and,

FIG. 7 is a bottom view thereof.

The broken line showing of the foot surface and indented side pieces below the foot surface of the stirrup show portions of a stirrup and form no part of the claimed design.

1 Claim, 7 Drawing Sheets

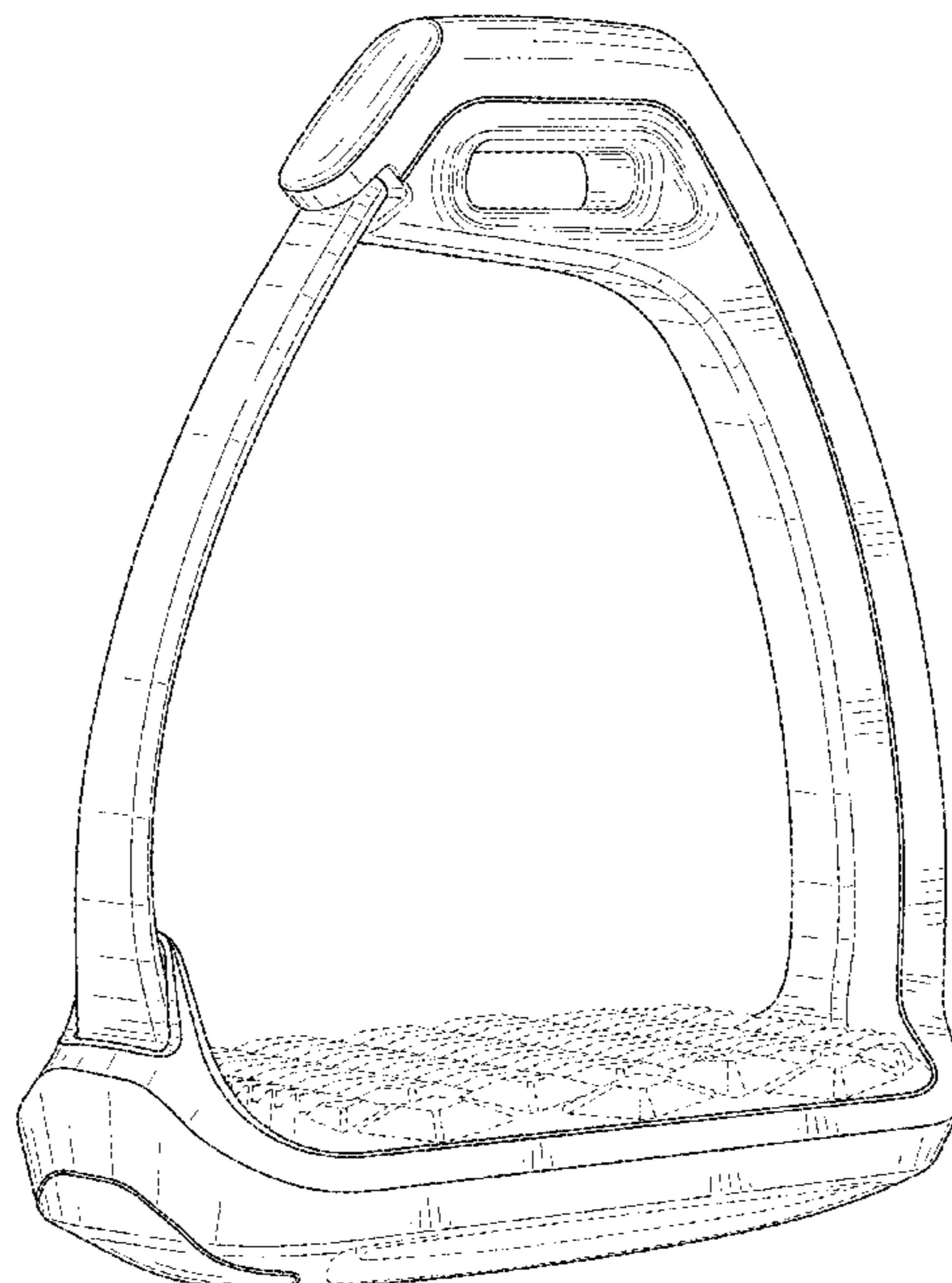

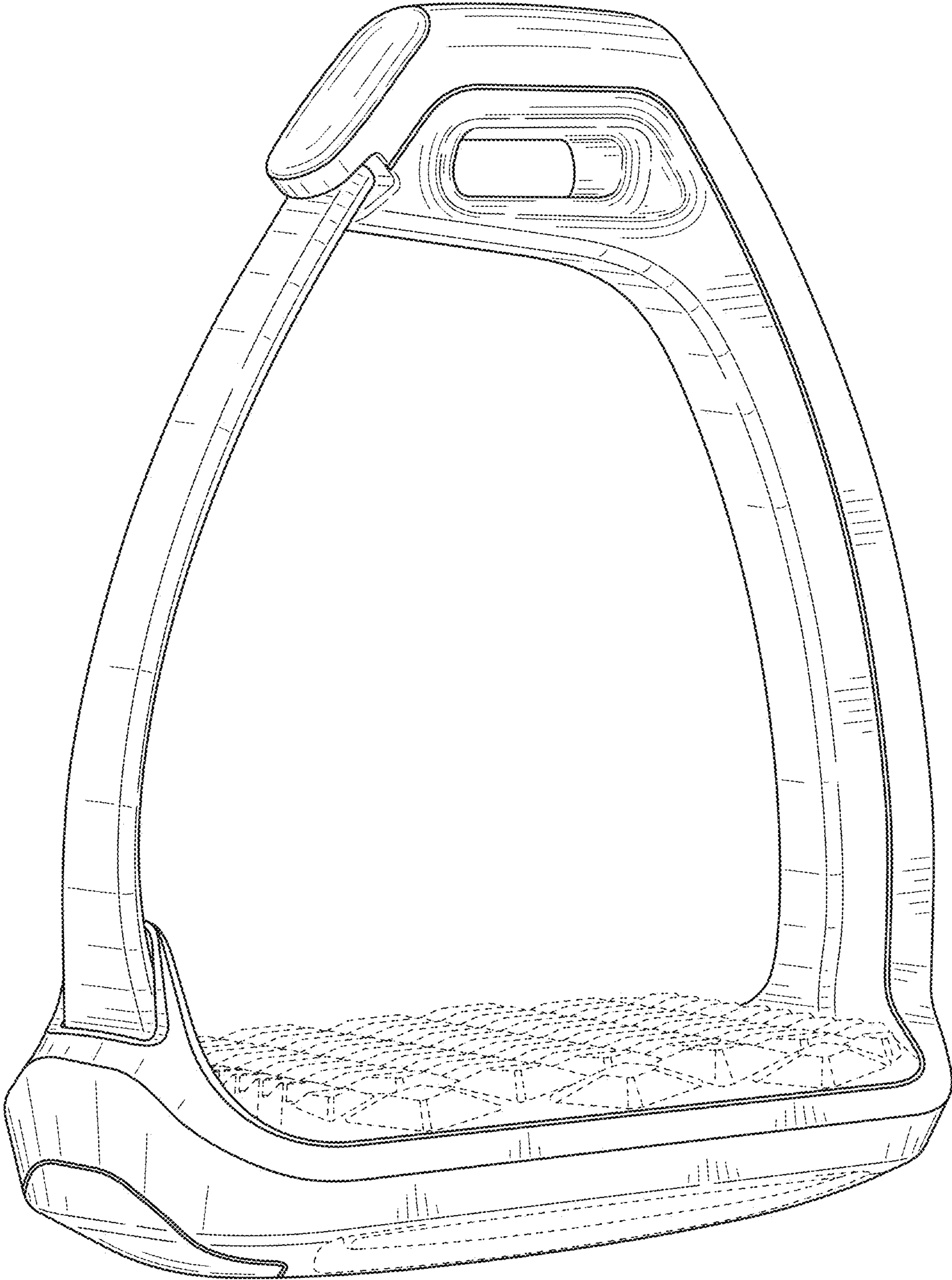

FIG. 1

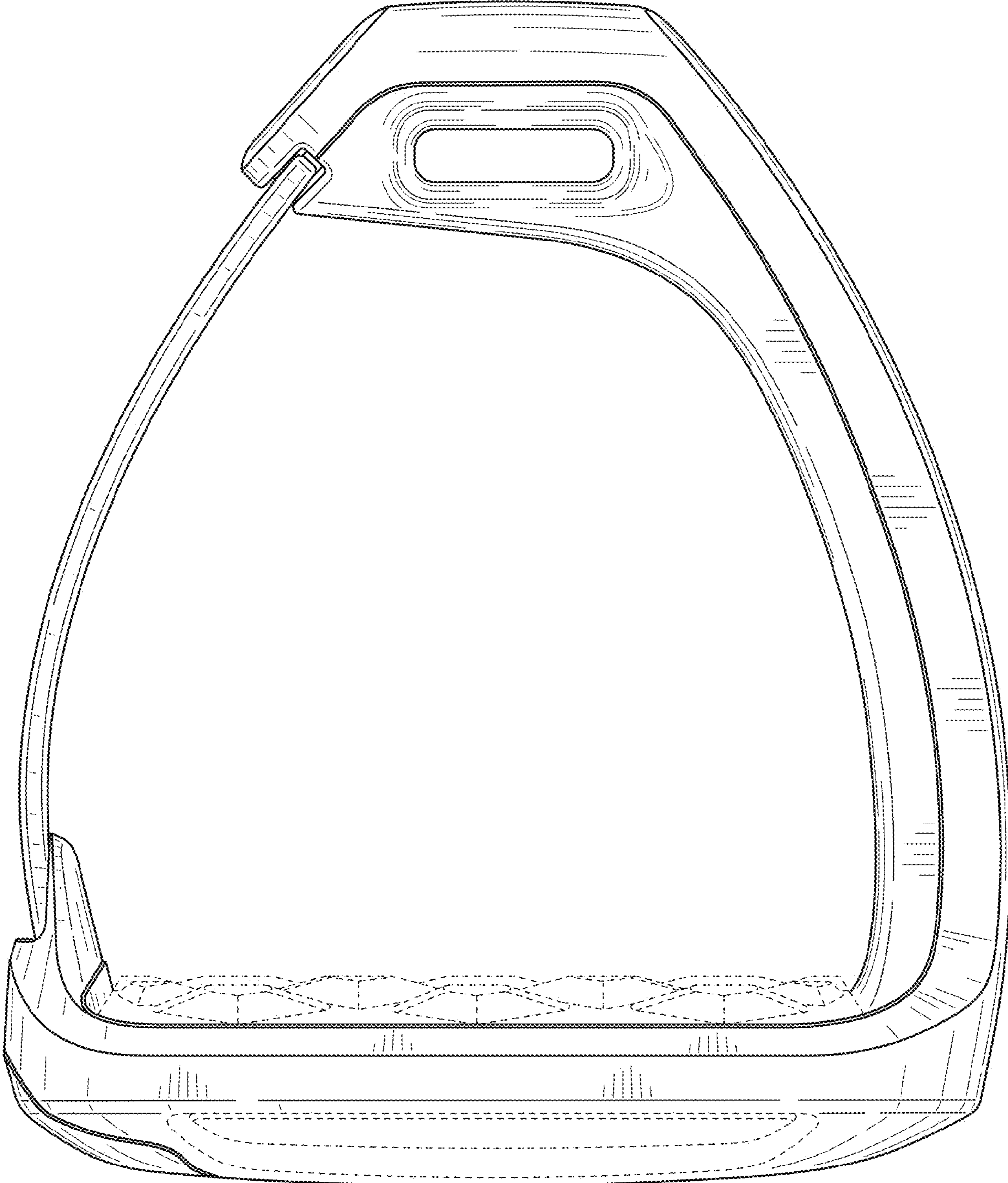

FIG. 2

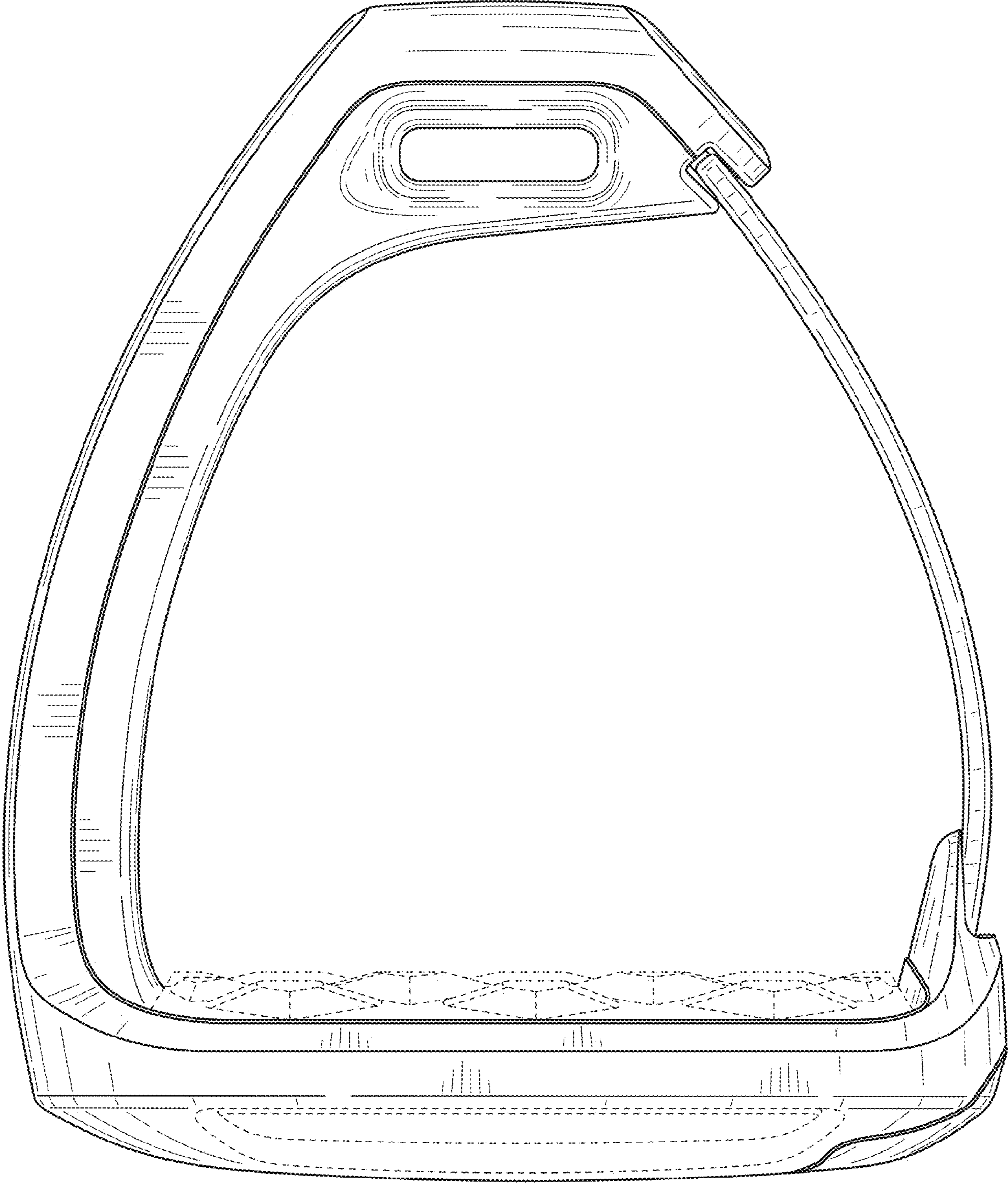

FIG. 3

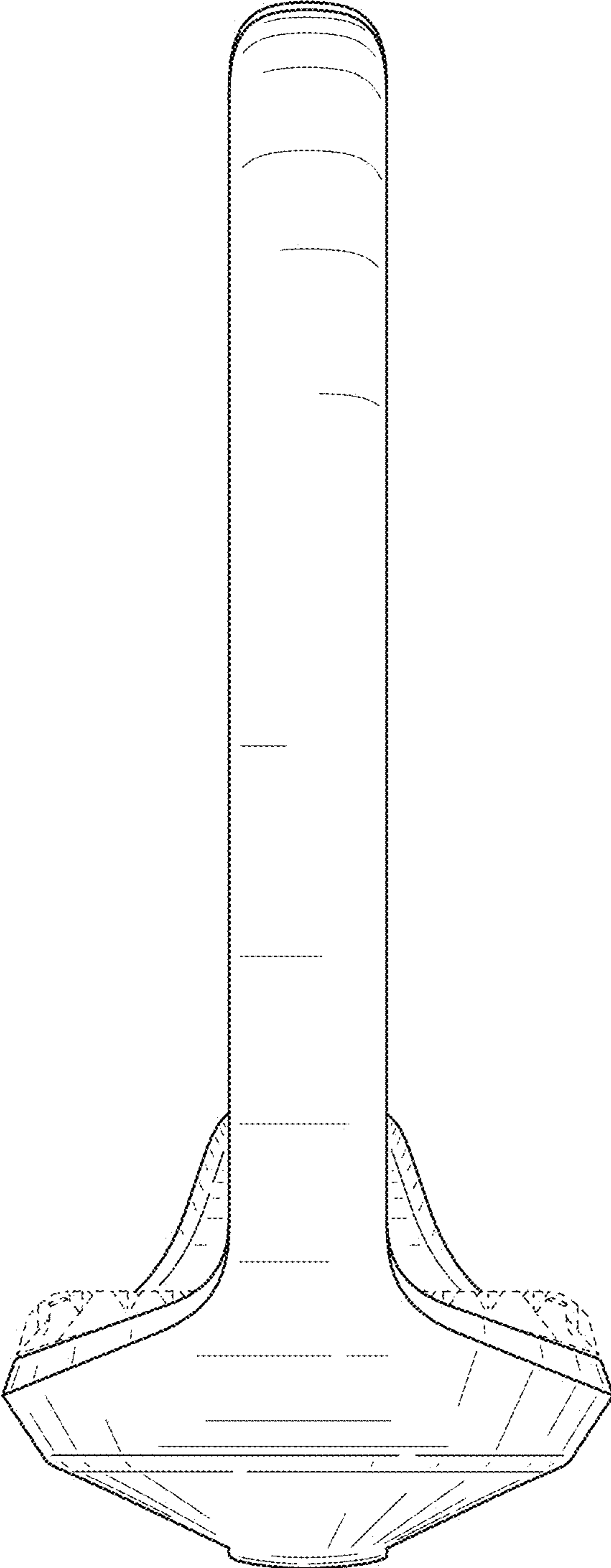

FIG. 4

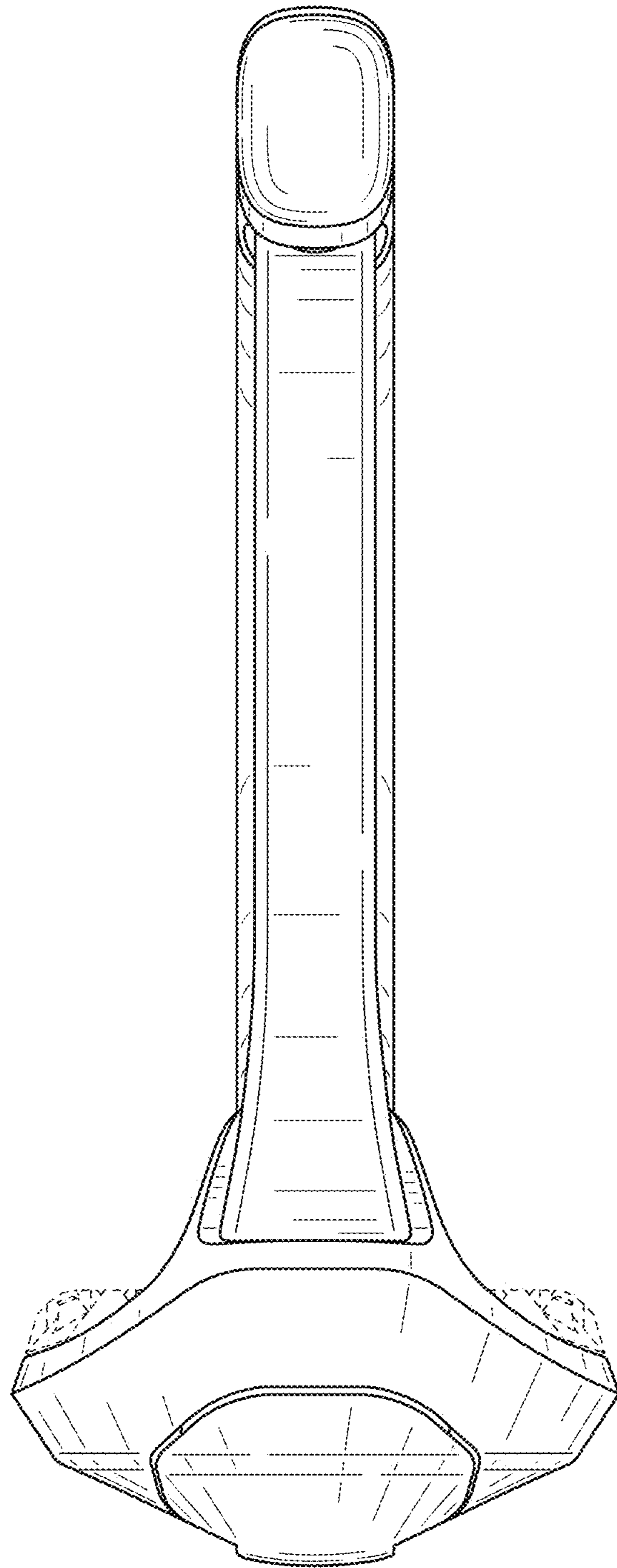

FIG. 5

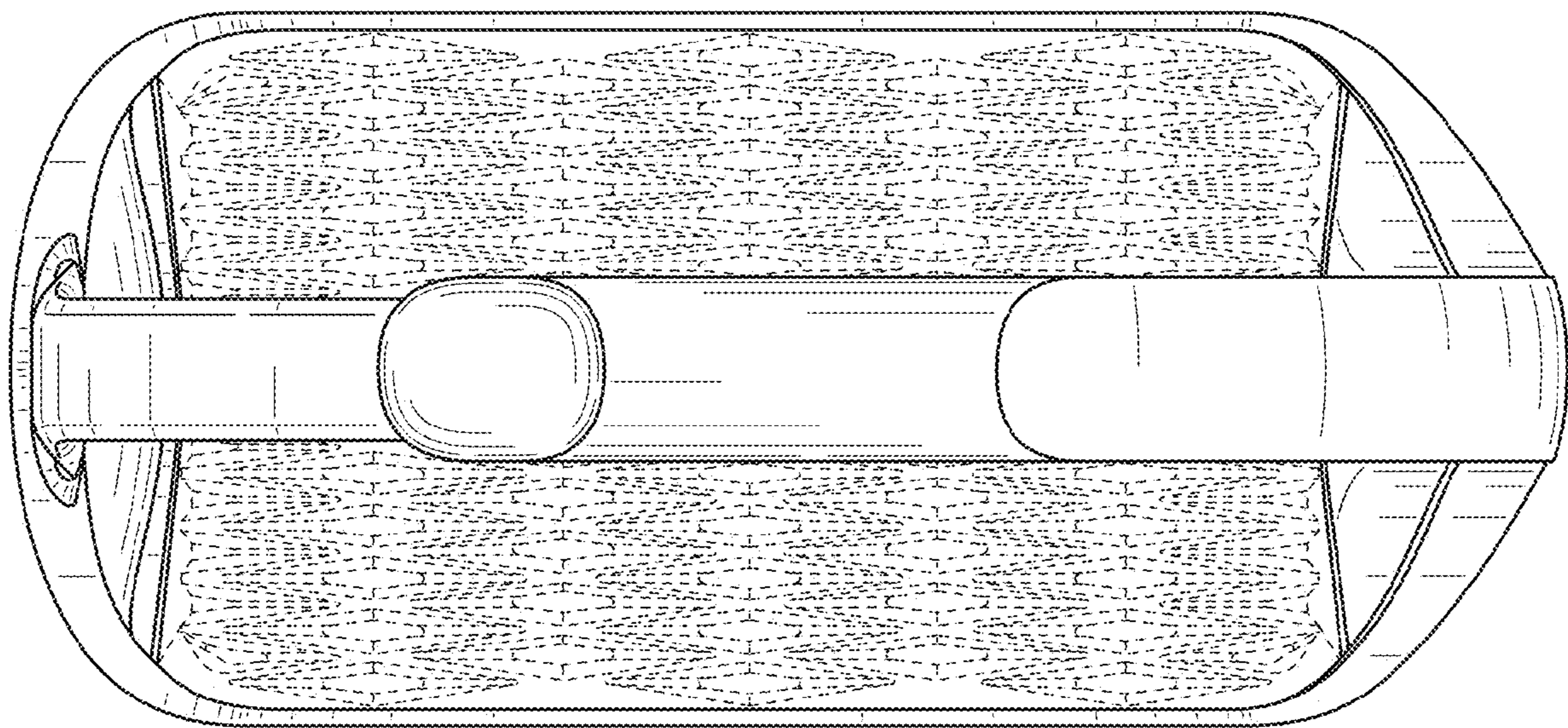

FIG. 6

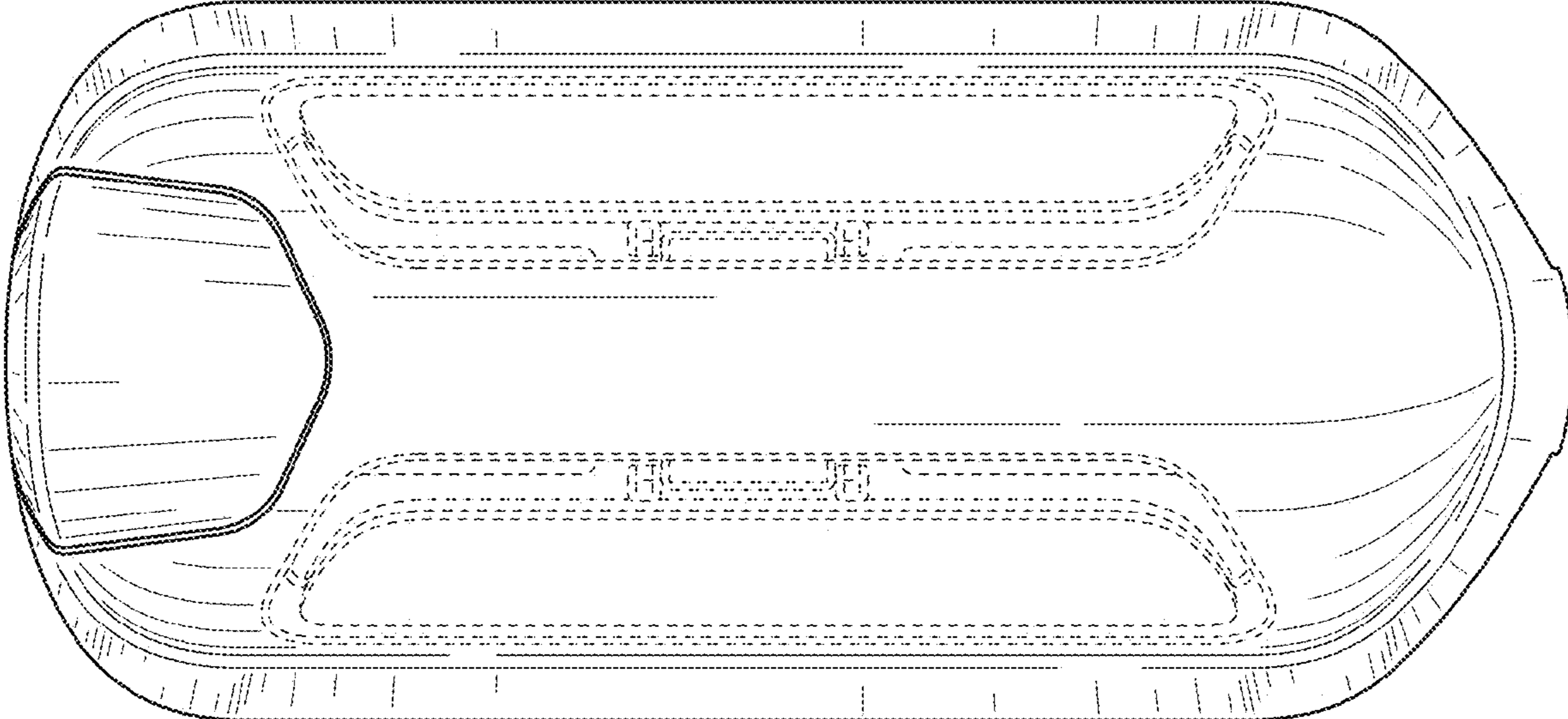

FIG. 7