



US00D909672S

(12) **United States Design Patent** (10) **Patent No.:** **US D909,672 S**
Williams (45) **Date of Patent:** **** Feb. 2, 2021**

(54) **MASCARA SHIELD**

(71) Applicant: **Brandi M. Williams**, Los Angeles, CA (US)

(72) Inventor: **Brandi M. Williams**, Los Angeles, CA (US)

(**) Term: **15 Years**

(21) Appl. No.: **29/652,097**

(22) Filed: **May 12, 2020**

(51) **LOC (13) Cl.** **28-03**

(52) **U.S. Cl.**
USPC **D28/7**

(58) **Field of Classification Search**
USPC D28/4, 7, 99; D24/189, 190; D16/100
CPC A45D 40/30; A45D 44/00; A45D 44/12;
A61F 9/04
See application file for complete search history.

(56) **References Cited**

U.S. PATENT DOCUMENTS

1,850,540	A	3/1932	Erickson	
2,527,947	A *	10/1950	Loos	A61F 9/04 604/294
3,619,815	A	11/1971	Towner, Jr.	
D311,409	S *	10/1990	Goffman	D16/100
5,050,624	A	9/1991	Kobe et al.	
D341,001	S *	11/1993	Pantages	D28/7
D440,660	S *	4/2001	Sternberg	D24/190
6,320,094	B1 *	11/2001	Arnold	A61F 13/124 128/858
D509,024	S *	8/2005	Pimentel	D28/4
D639,441	S *	6/2011	Sferle	D24/189
8,235,060	B2	8/2012	Konrad	
D673,326	S	12/2012	Dunaway	
D703,334	S *	4/2014	Hardin	D24/189
8,925,558	B2	1/2015	Johnson	
D740,952	S *	10/2015	Kawahara	D24/189
D758,009	S *	5/2016	Berkos	D28/7

(Continued)

Primary Examiner — Zenia I Bennett

(74) *Attorney, Agent, or Firm* — Dunlap Bennett & Ludwig, PLLC

(57) **CLAIM**

The ornamental design for a mascara shield, as shown and described.

DESCRIPTION

FIG. 1 is a front right top perspective view of a first embodiment of the makeup shield, showing my new design; FIG. 2 is a front elevation view of the first embodiment of the makeup shield; FIG. 3 is a rear elevation view of the first embodiment of the makeup shield; FIG. 4 is a left elevation view of the first embodiment of the makeup shield; FIG. 5 is a right elevation view of the first embodiment of the makeup shield; FIG. 6 is a top view of the first embodiment of the makeup shield; FIG. 7 is a bottom view of the first embodiment of the makeup shield; FIG. 8 is a front left top perspective view of a second embodiment of the makeup shield; FIG. 9 is a front elevation view of the second embodiment of the makeup shield; FIG. 10 is a rear elevation view of the second embodiment of the makeup shield; FIG. 11 is a left elevation view of the second embodiment of the makeup shield; FIG. 12 is a right elevation view of the second embodiment of the makeup shield; FIG. 13 is a top view of the second embodiment of the makeup shield; and, FIG. 14 is a bottom view of the second embodiment of the makeup shield.

1 Claim, 4 Drawing Sheets

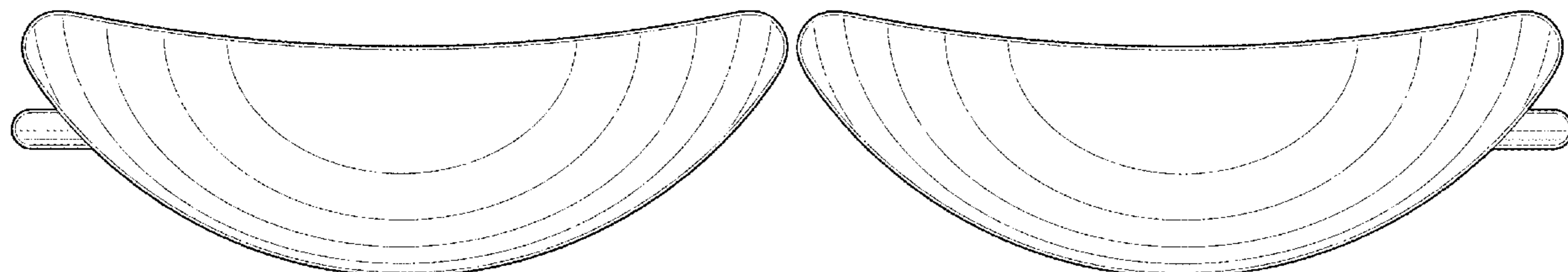

(56)

References Cited

U.S. PATENT DOCUMENTS

D798,460 S * 9/2017 Farley D24/189
D852,412 S 6/2019 Grund et al.
D853,028 S * 7/2019 Hacopian D28/7
D865,183 S * 10/2019 Otani D24/189
D878,609 S * 3/2020 Simmons D24/189
2009/0151744 A1 6/2009 Villanueva
2010/0018542 A1 1/2010 Konrad
2010/0154813 A1 6/2010 Deeds

* cited by examiner

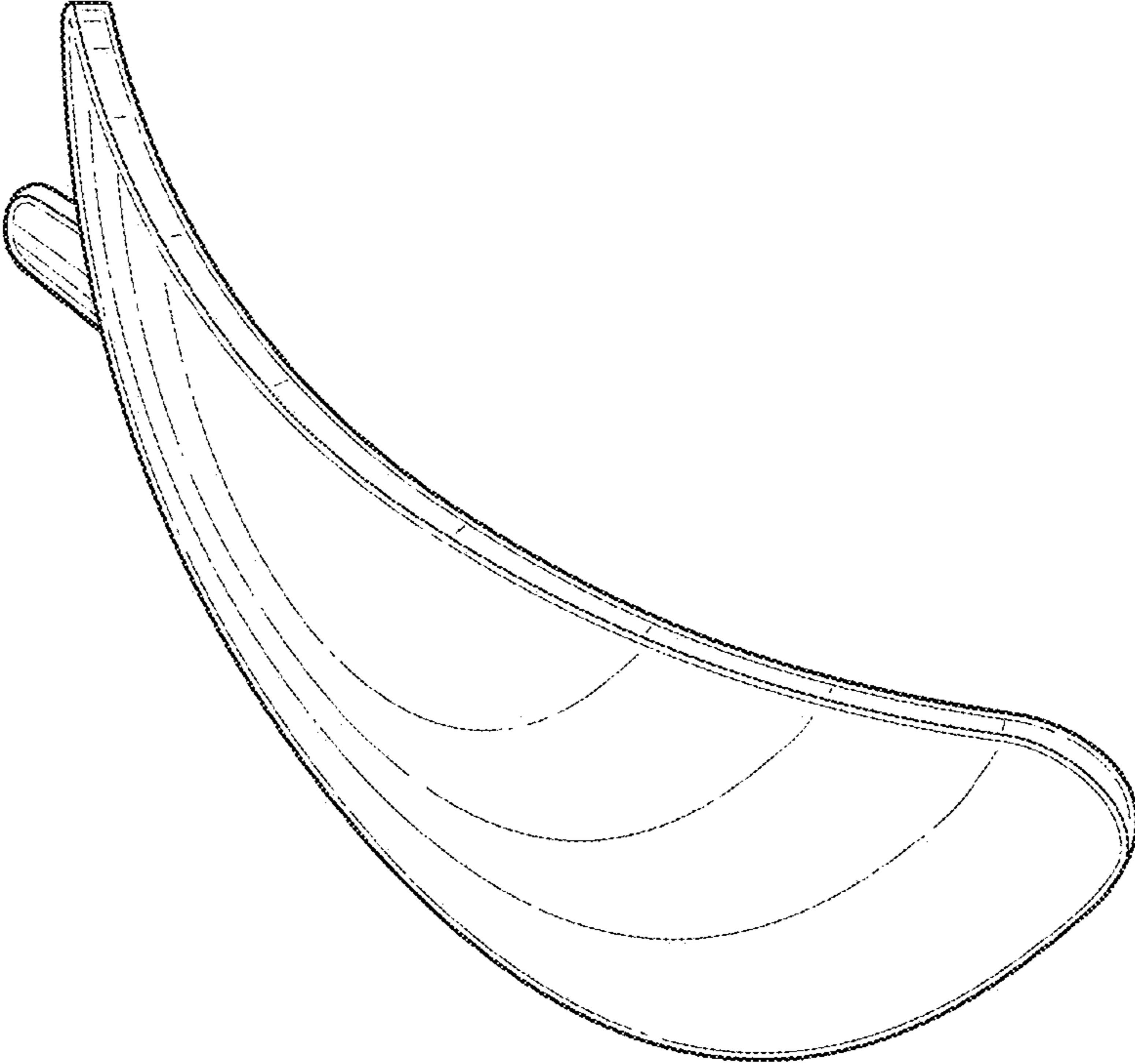

FIG. 1

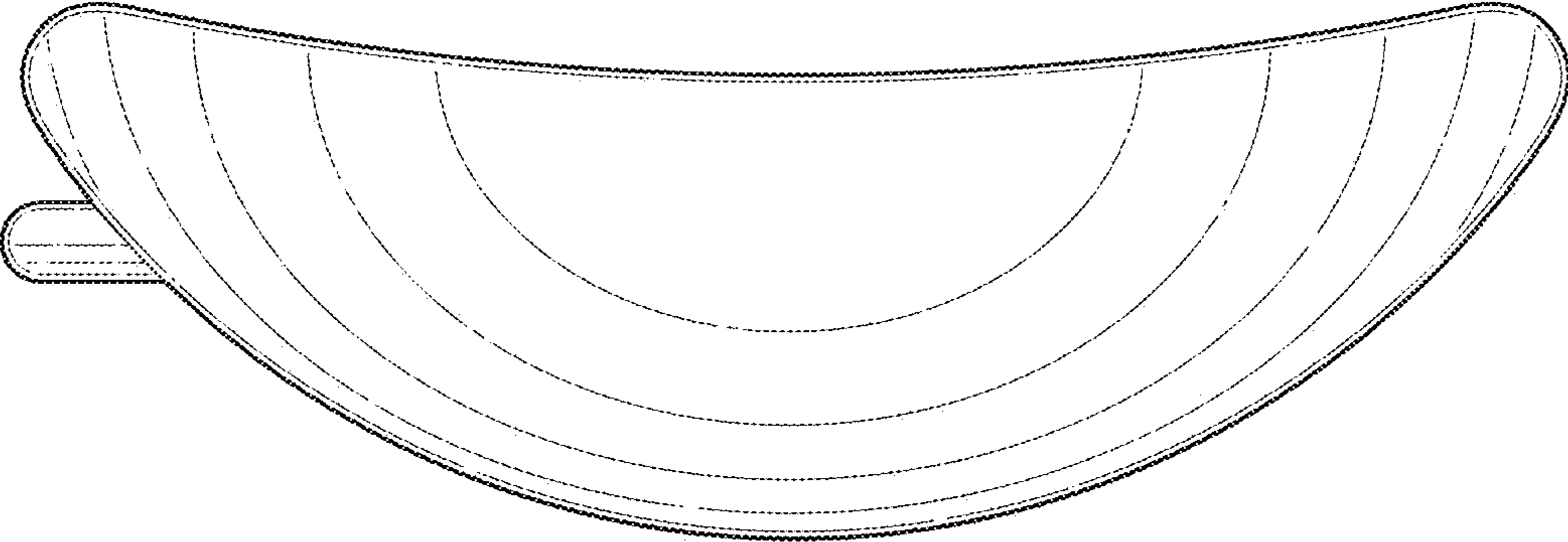

FIG. 2

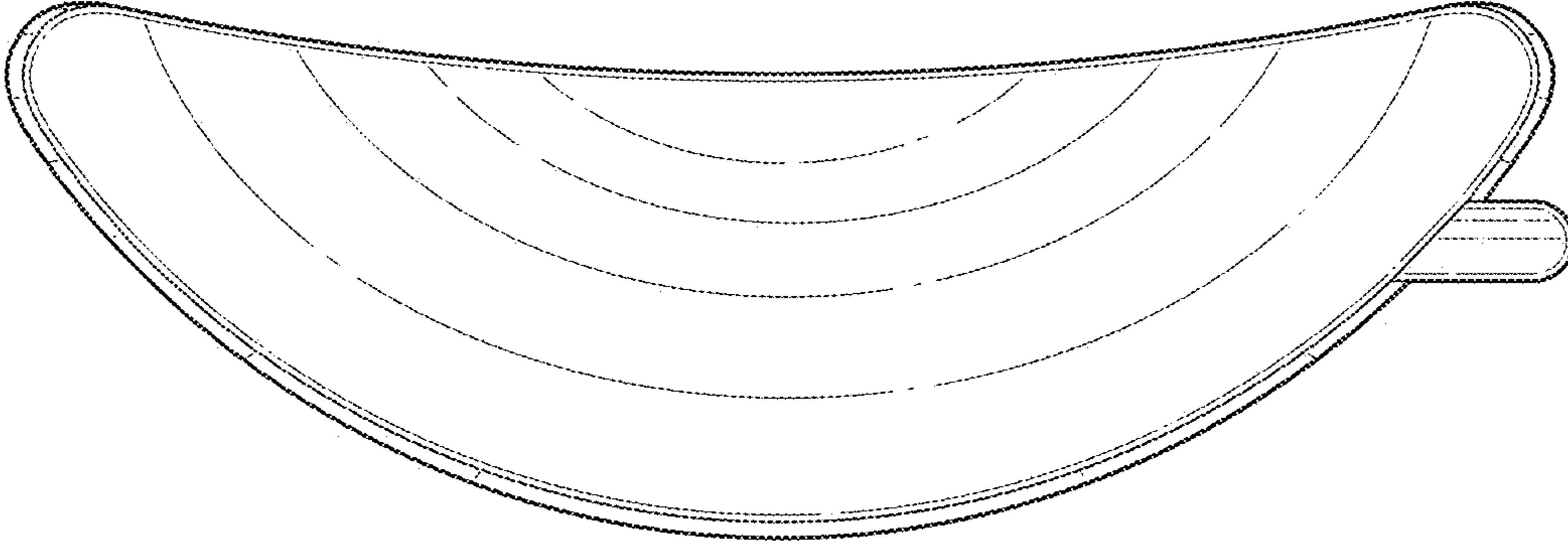

FIG. 3

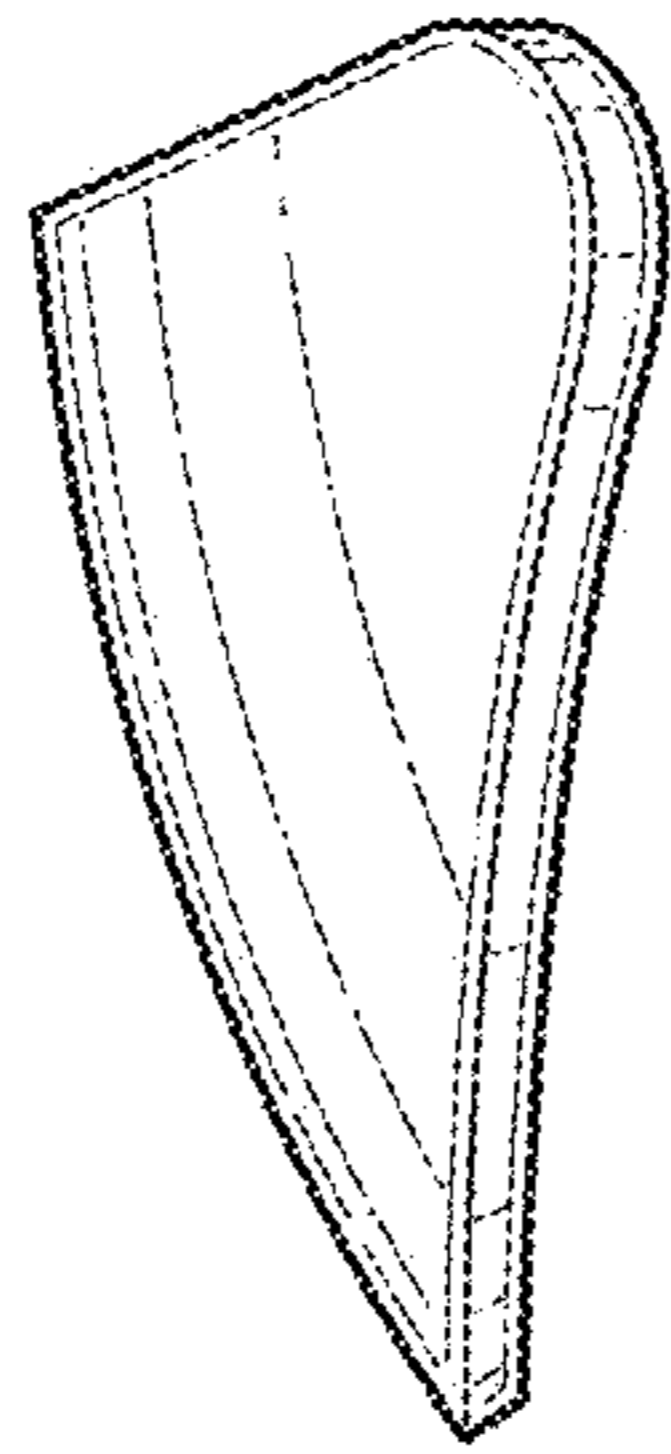

FIG. 5

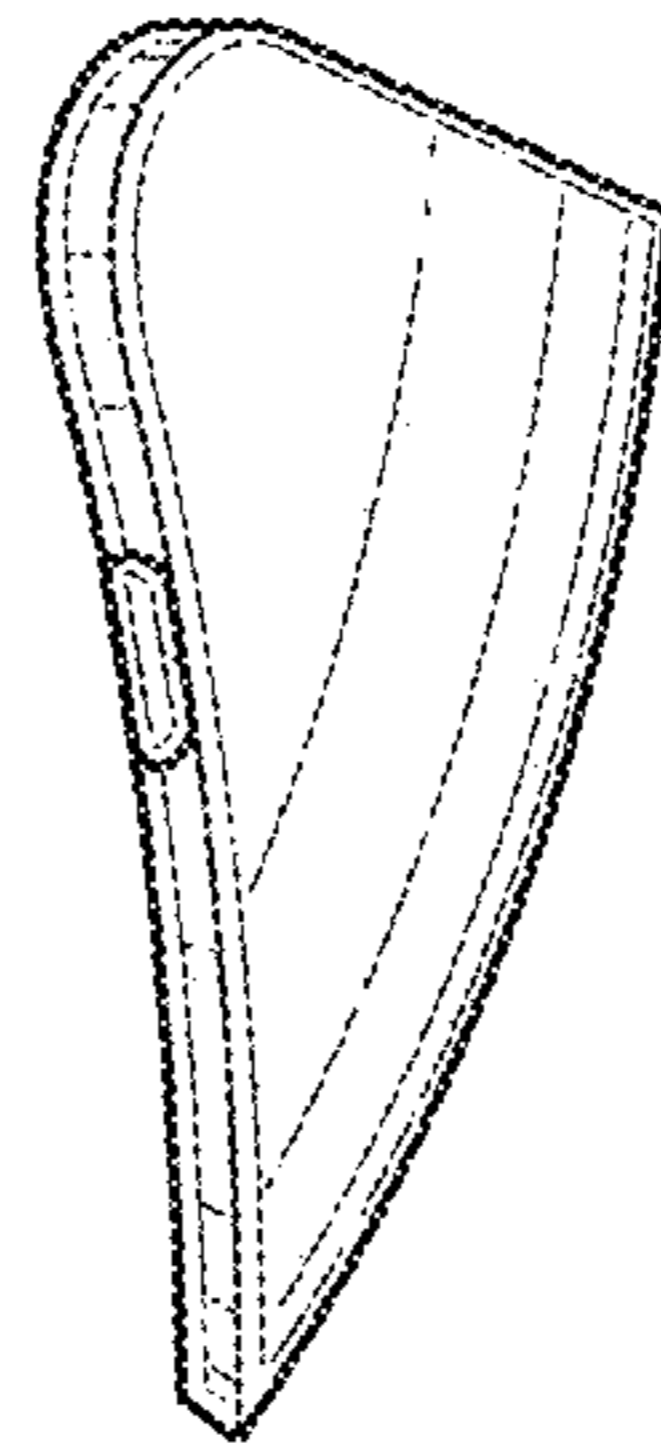

FIG. 4

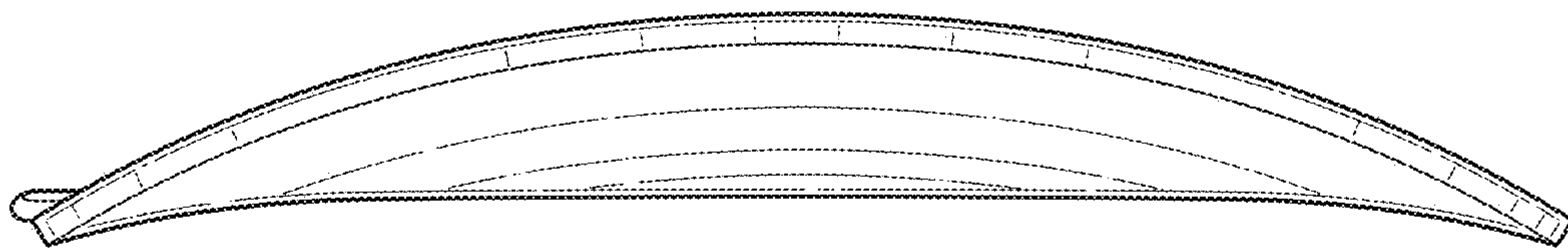

FIG. 6

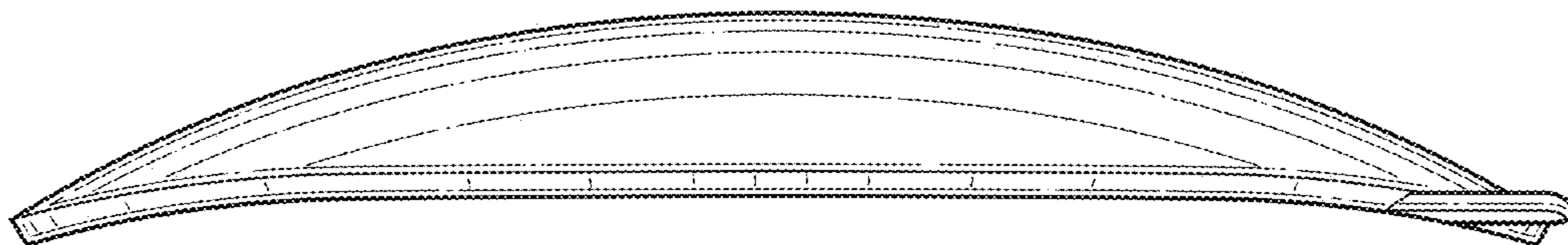

FIG. 7

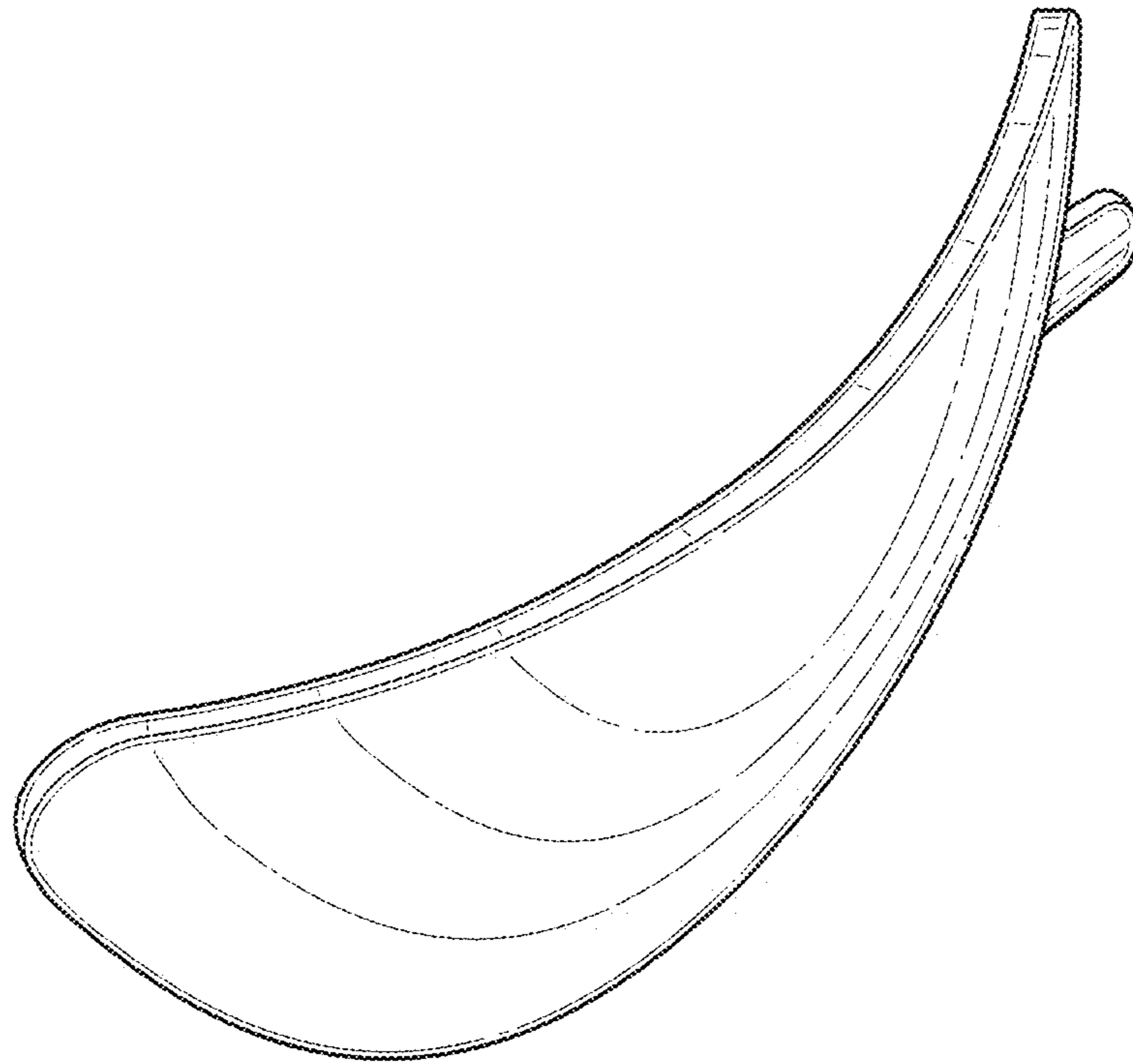

FIG. 8

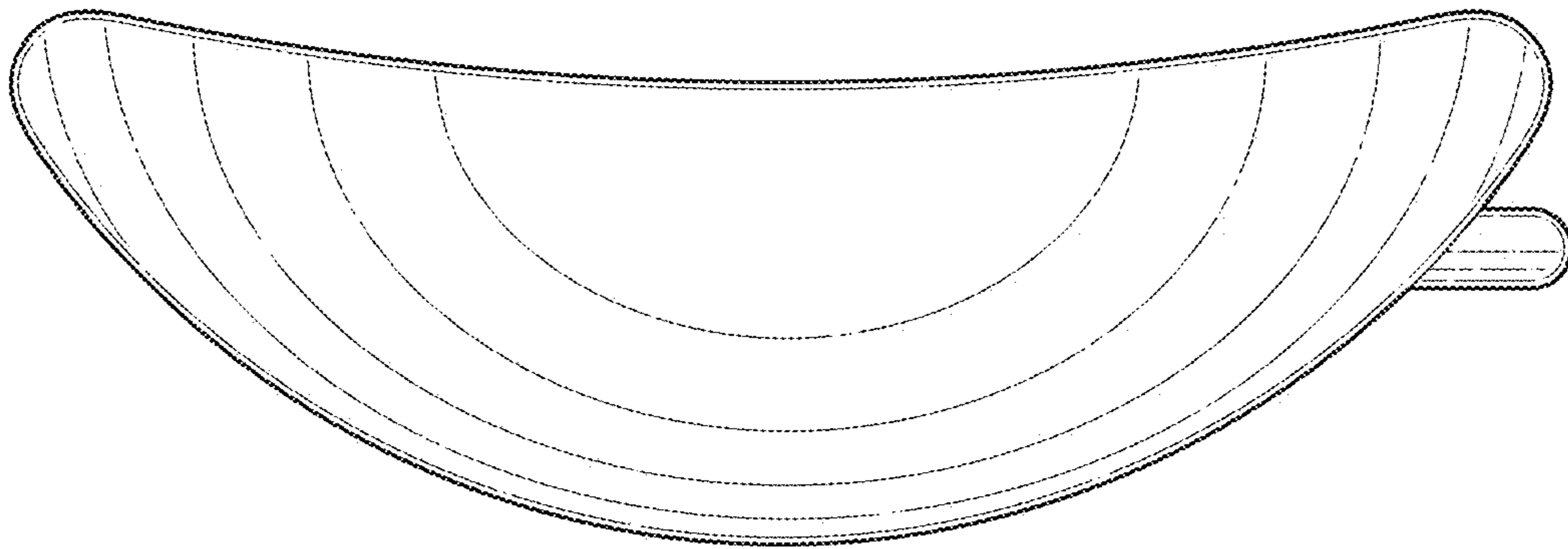

FIG. 9

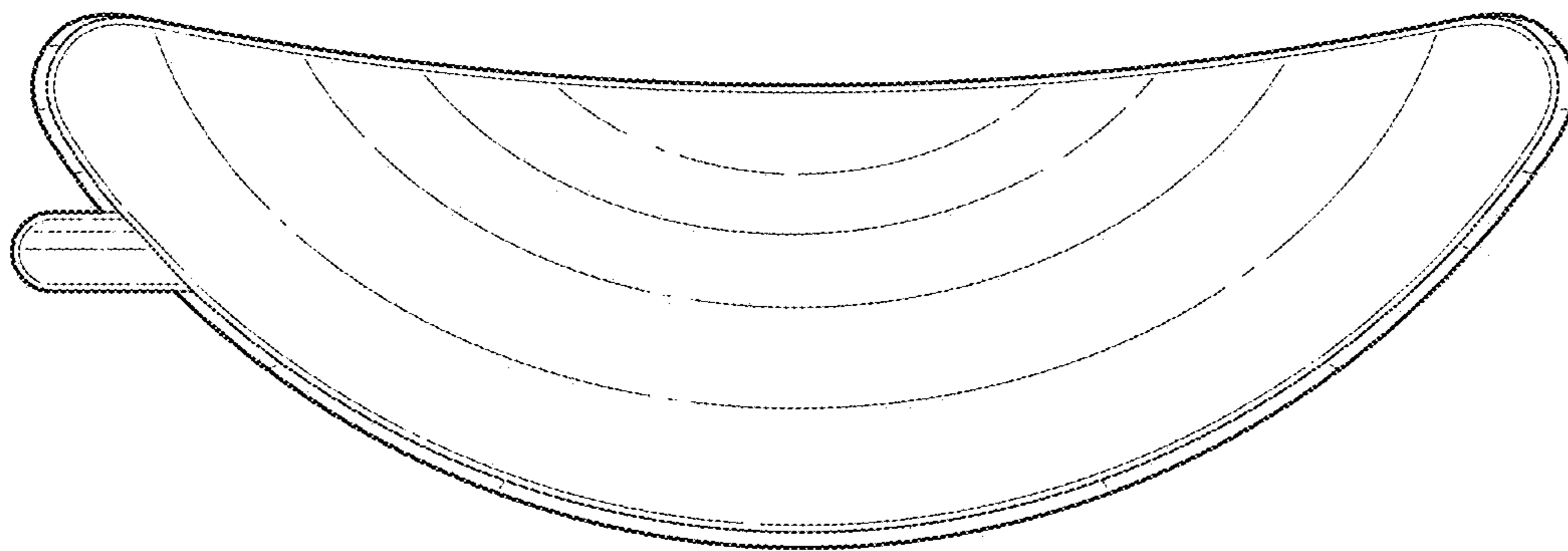

FIG. 10

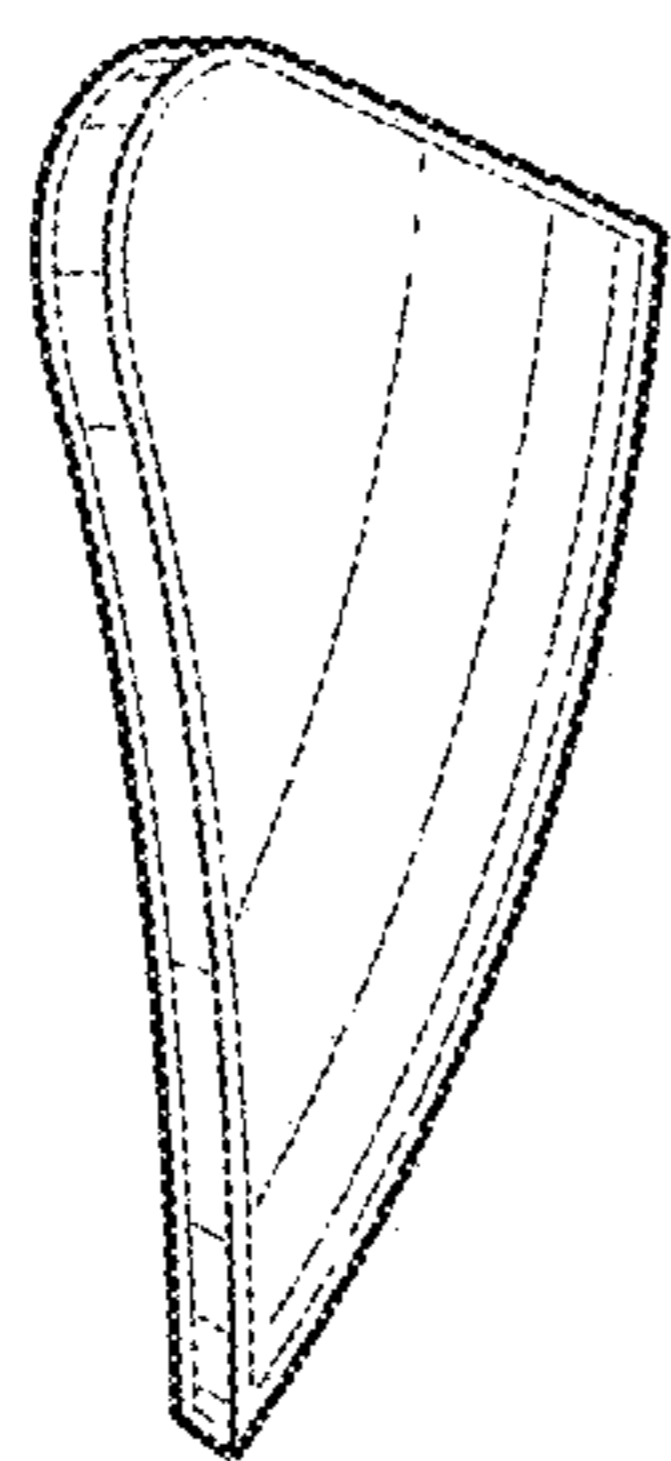

FIG. 11

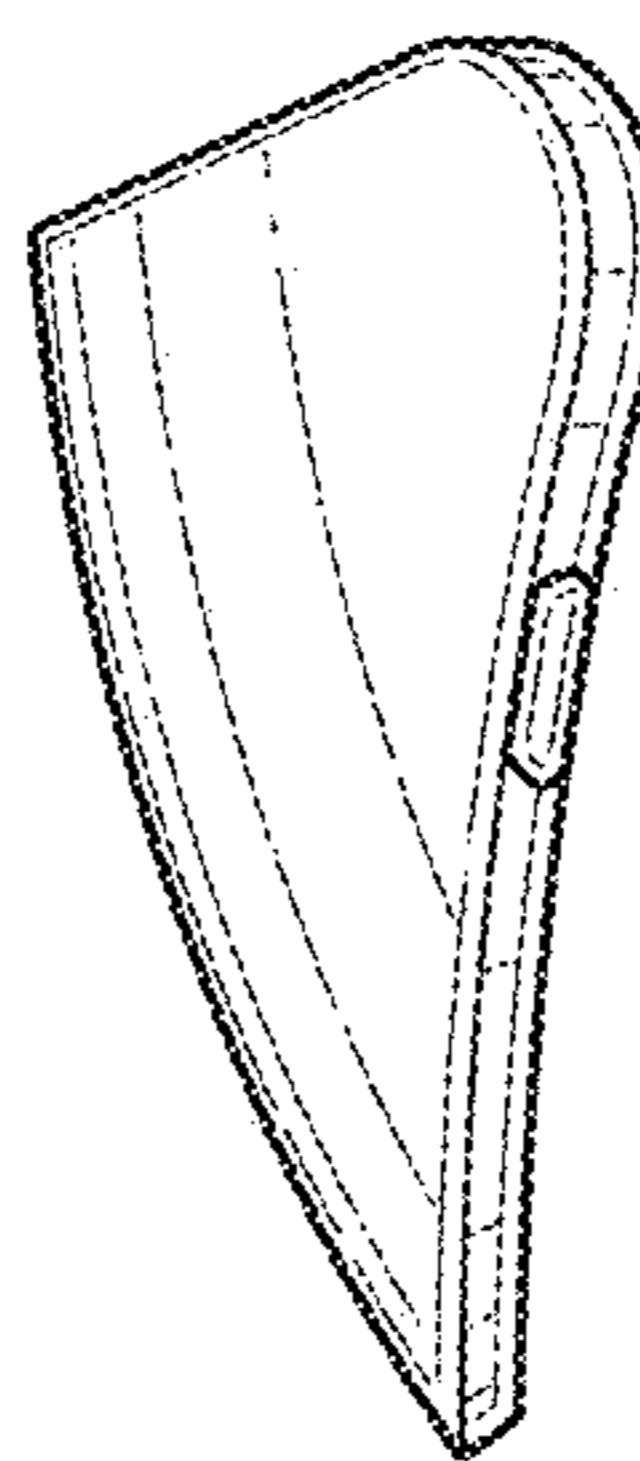

FIG. 12

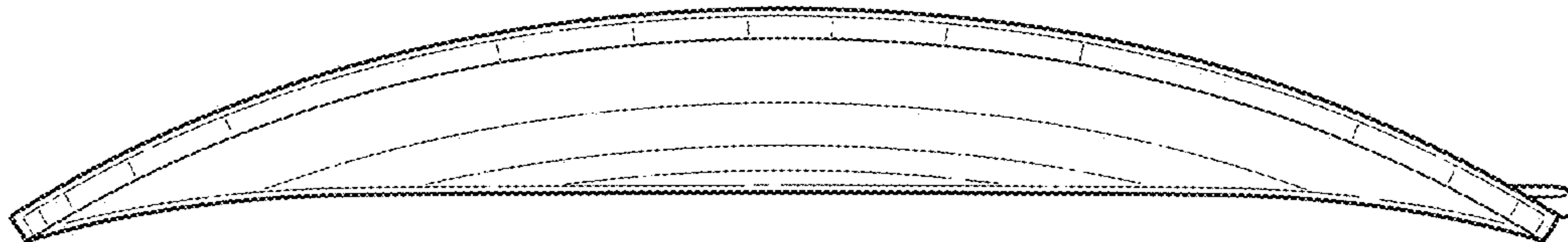

FIG. 13

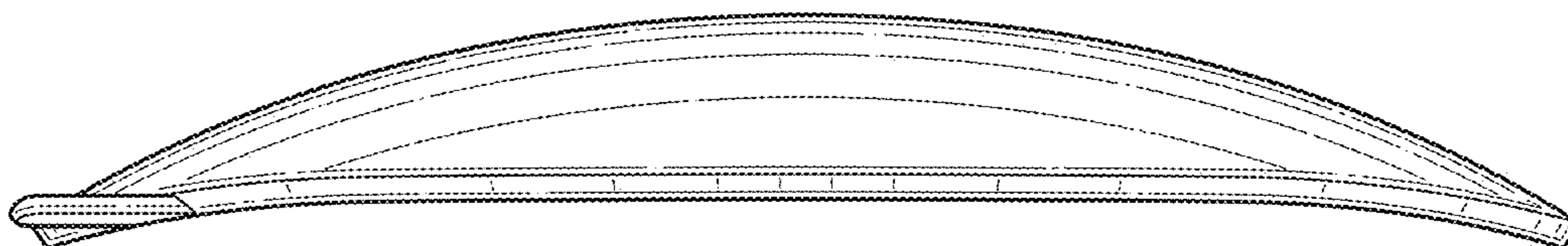

FIG. 14