



US00D909668S

(12) **United States Design Patent** (10) **Patent No.:** **US D909,668 S**
Chen (45) **Date of Patent:** **** Feb. 2, 2021**

(54) **ELECTRONIC CIGARETTE**
(71) Applicant: **Yushui Chen**, Quanzhou (CN)
(72) Inventor: **Yushui Chen**, Quanzhou (CN)
(**) Term: **15 Years**
(21) Appl. No.: **29/695,790**
(22) Filed: **Jun. 21, 2019**
(51) **LOC (13) Cl.** **27-02**
(52) **U.S. Cl.**
USPC **D27/162**
(58) **Field of Classification Search**
USPC D27/162, 100, 101, 163–165, 172, 174,
D27/183, 185–194; D24/110, 110.5;
128/202.21, 203.12; 131/273, 274, 270,
131/191, 328, 329, 330, 360–365;
D23/360, 366
CPC A24F 47/002; A24F 47/006; A24F 47/008;
A61M 15/00; A61M 15/06
See application file for complete search history.

D898,992 S * 10/2020 Chen D27/162
D901,756 S * 11/2020 Chen D27/101
D903,191 S * 11/2020 Li D27/101

* cited by examiner

Primary Examiner — Marissa J Cash
Assistant Examiner — Rebecca Tsehaye
(74) *Attorney, Agent, or Firm* — Novoclaims Patent
Services LLC; Mei Lin Wong

(57) **CLAIM**

The ornamental design for an electronic cigarette, as shown
and described.

DESCRIPTION

FIG. 1 is a perspective view of an electronic cigarette,
showing my new design;
FIG. 2 is another perspective view thereof;
FIG. 3 is a front view thereof;
FIG. 4 is a rear view thereof;
FIG. 5 is a left side view thereof;
FIG. 6 is a right side view thereof;
FIG. 7 is an enlarged top view of FIG. 1;
FIG. 8 is an enlarged bottom view of FIG. 1
FIG. 9 is a perspective view thereof, shown in opened in-use
condition;
FIG. 10 is another perspective view thereof;
FIG. 11 is a front view thereof;
FIG. 12 is a rear view thereof;
FIG. 13 is a left side view thereof;
FIG. 14 is a right side view thereof;
FIG. 15 is an enlarged top view of FIG. 9; and,
FIG. 16 is an enlarged bottom of FIG. 9.
The broken lines in the drawings depict portions of the
electronic cigarette that forms no part of the claimed design.

(56) **References Cited**
U.S. PATENT DOCUMENTS

D759,303 S * 6/2016 Afridi D27/101
D799,110 S * 10/2017 Qiu D27/101
D799,112 S * 10/2017 Qiu D27/101
D799,113 S * 10/2017 Qiu D27/101
D815,341 S * 4/2018 Qiu D27/101
D818,636 S * 5/2018 Qiu D27/101
D829,371 S * 9/2018 Durand D27/101
D829,980 S * 10/2018 Qiu D27/162
D833,064 S * 11/2018 Verleur D27/172
D834,246 S * 11/2018 Qiu D27/162
D861,239 S * 9/2019 Chen D27/101
D864,476 S * 10/2019 Qiu D27/162
D874,059 S * 1/2020 Bailey D27/162
D875,302 S * 2/2020 Pan D27/162

1 Claim, 16 Drawing Sheets

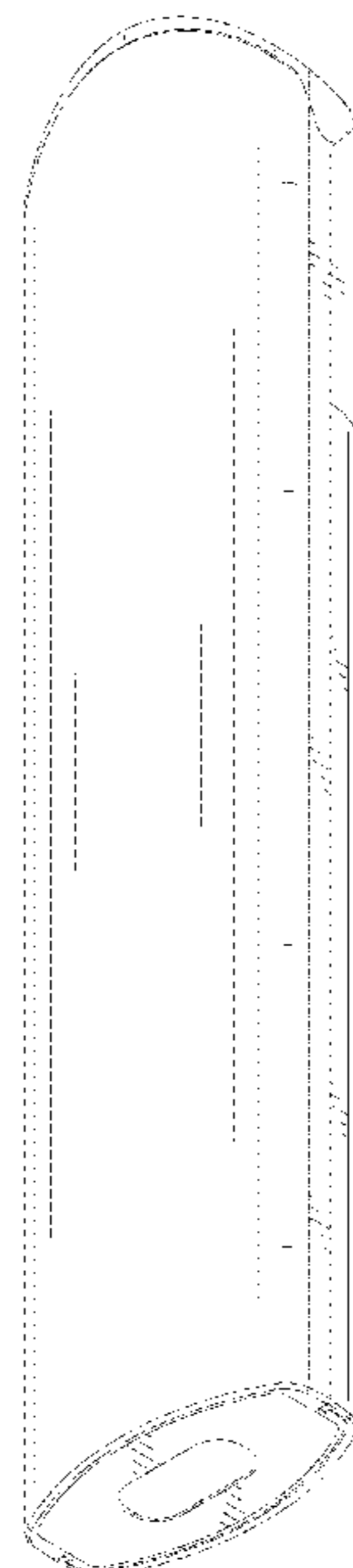

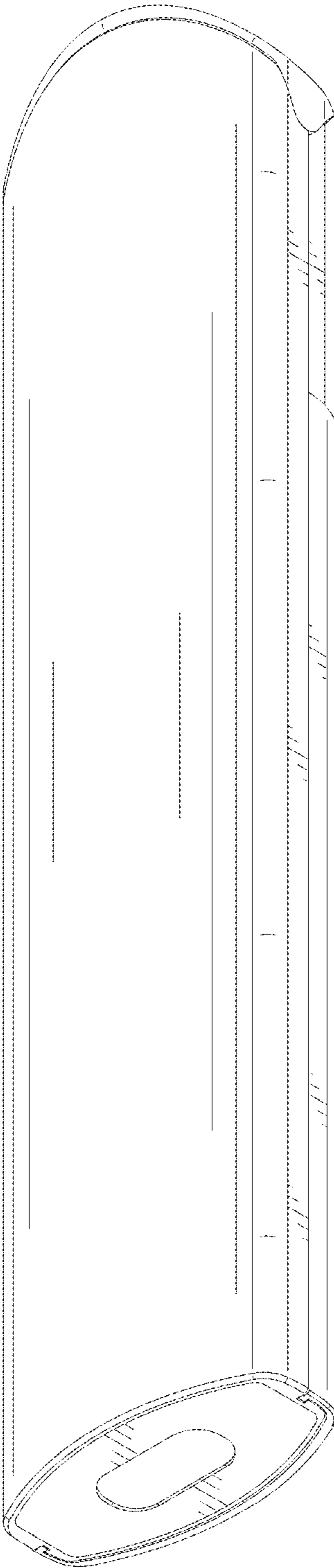

FIG.1

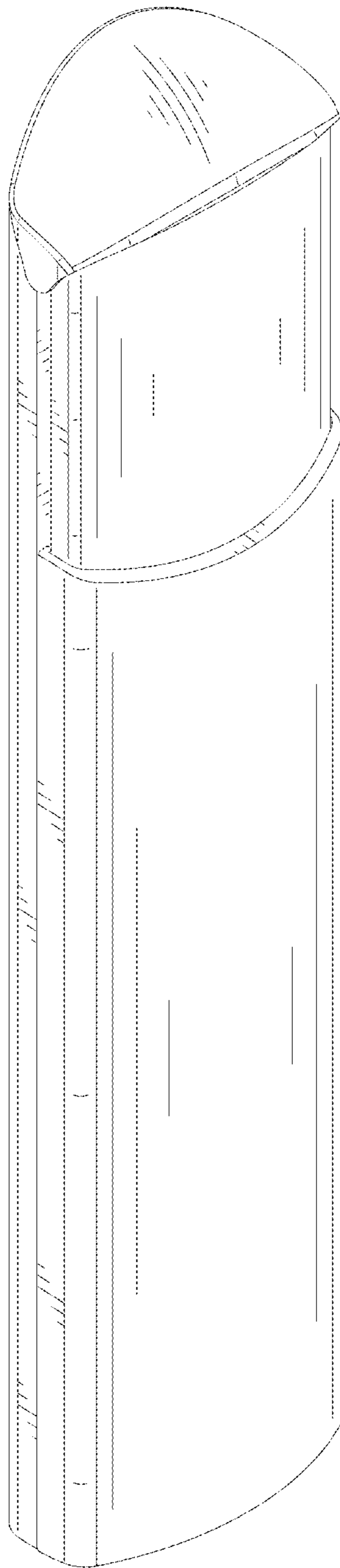

FIG.2

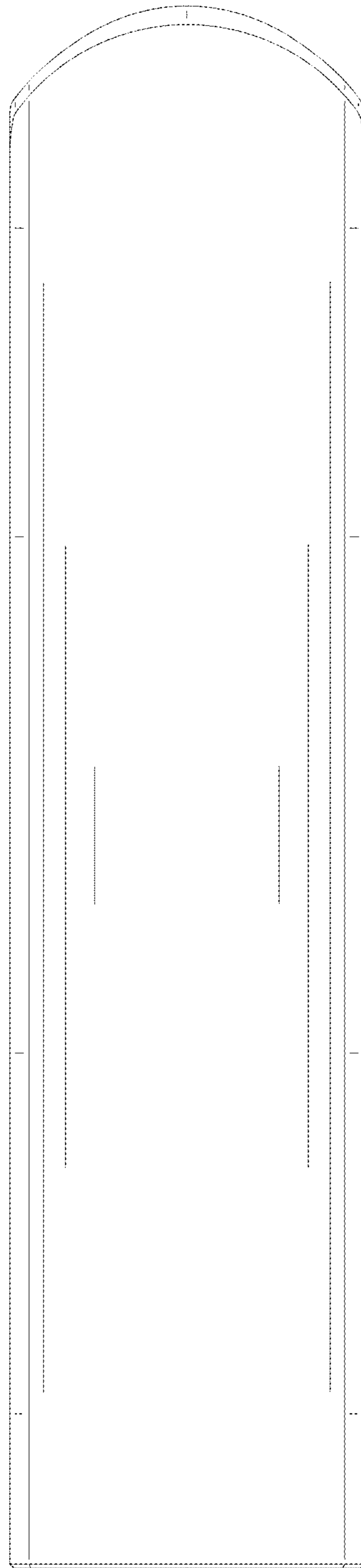

FIG.3

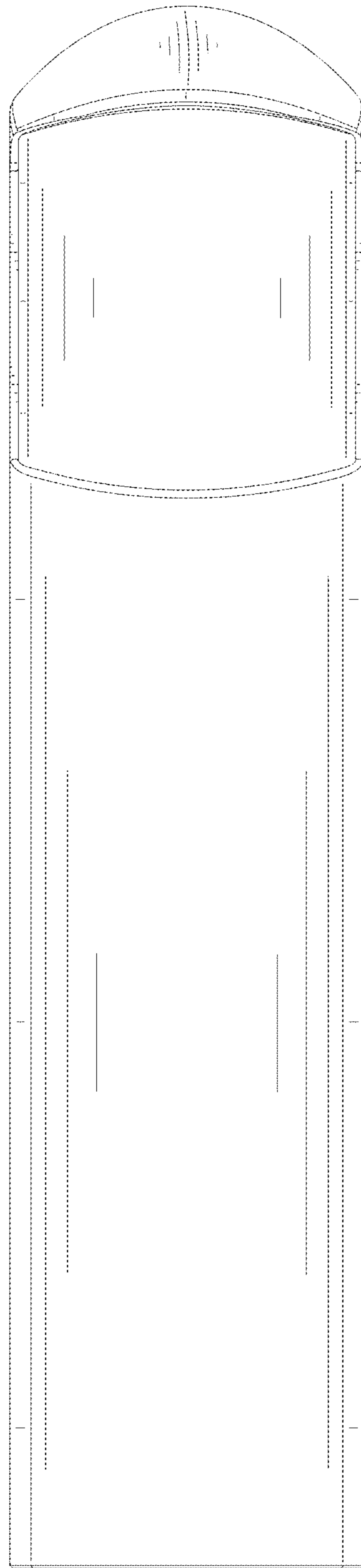

FIG.4

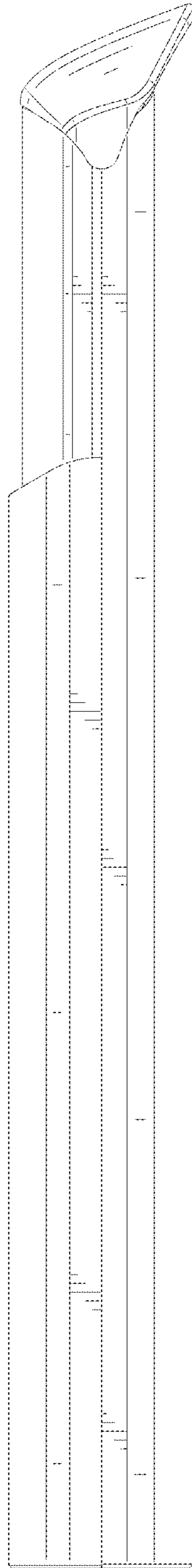

FIG.5

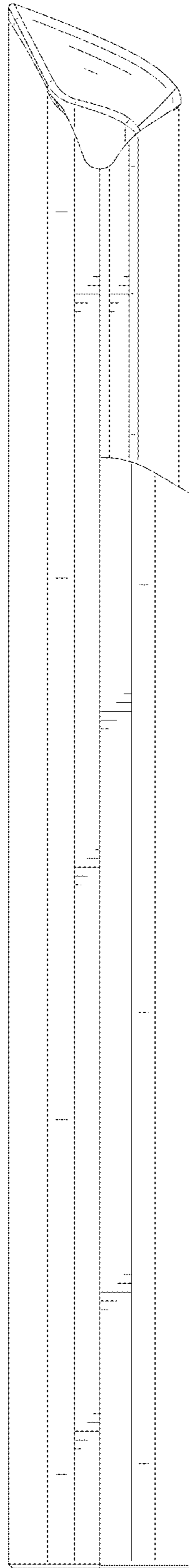

FIG.6

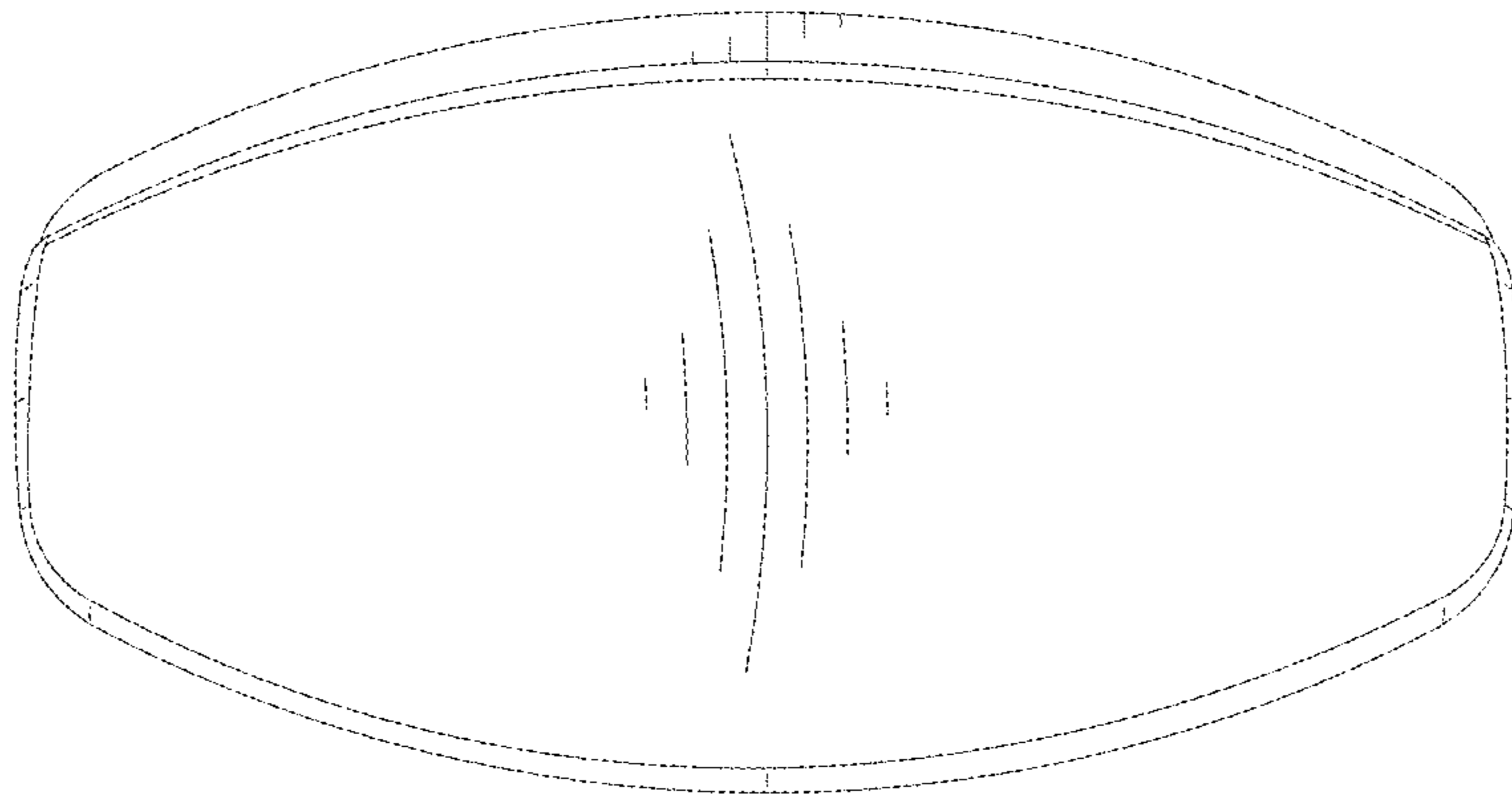

FIG.7

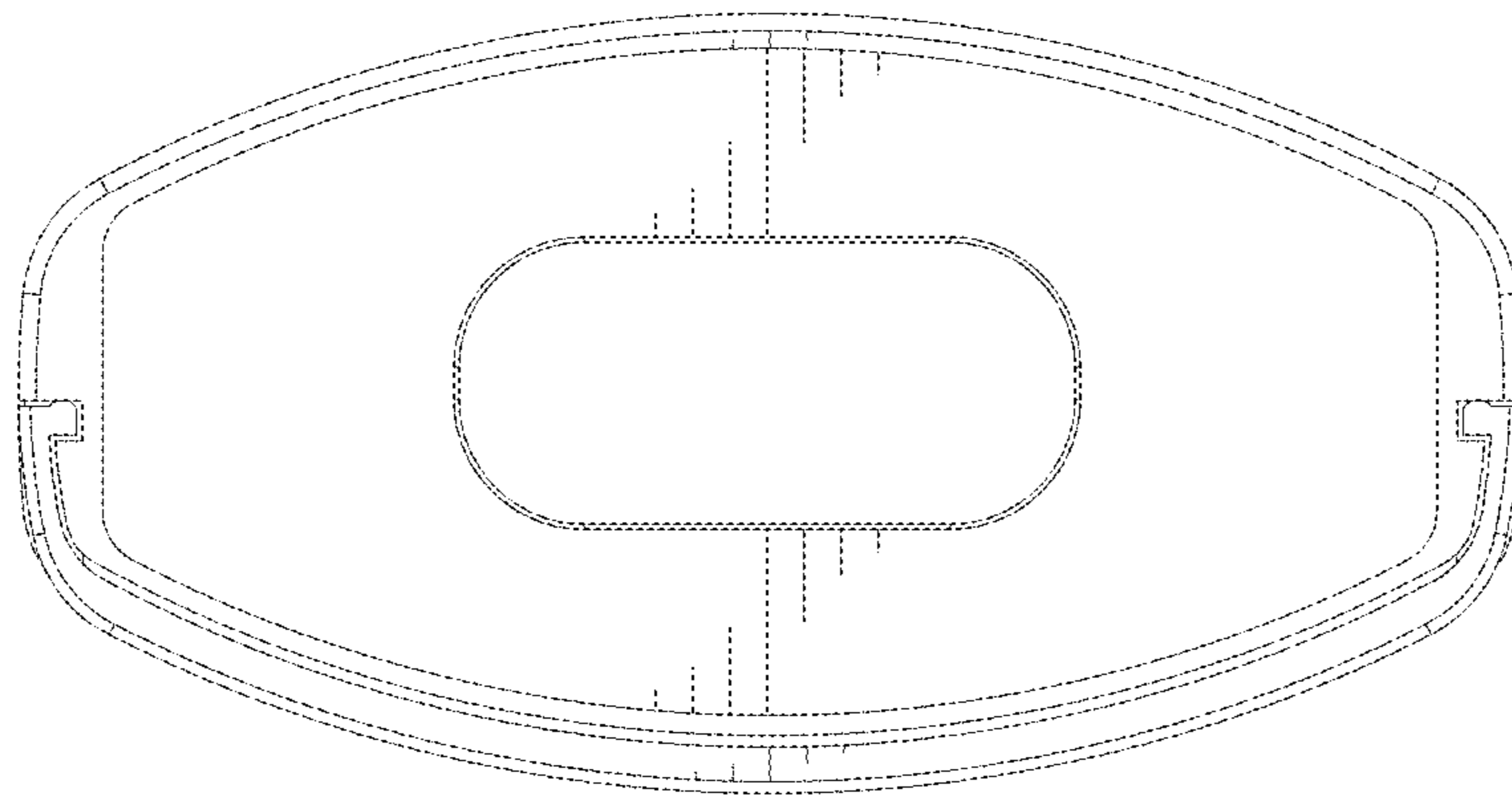

FIG.8

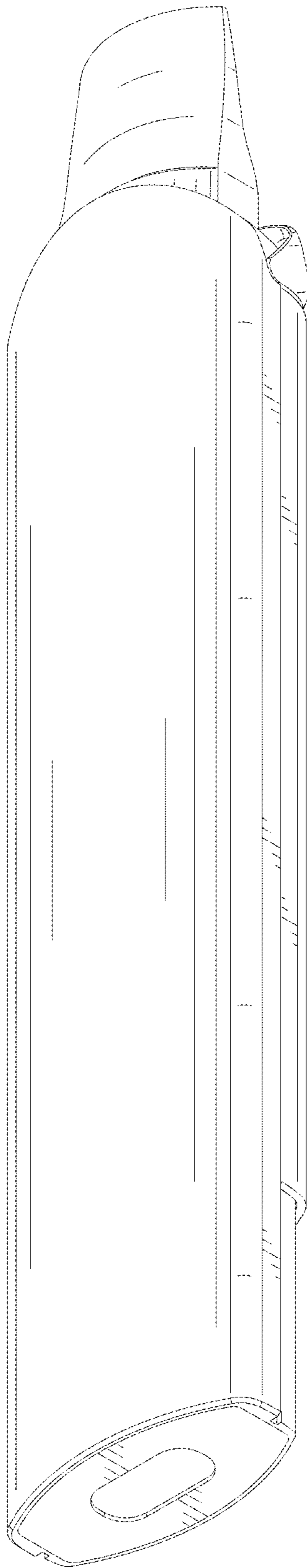

FIG.9

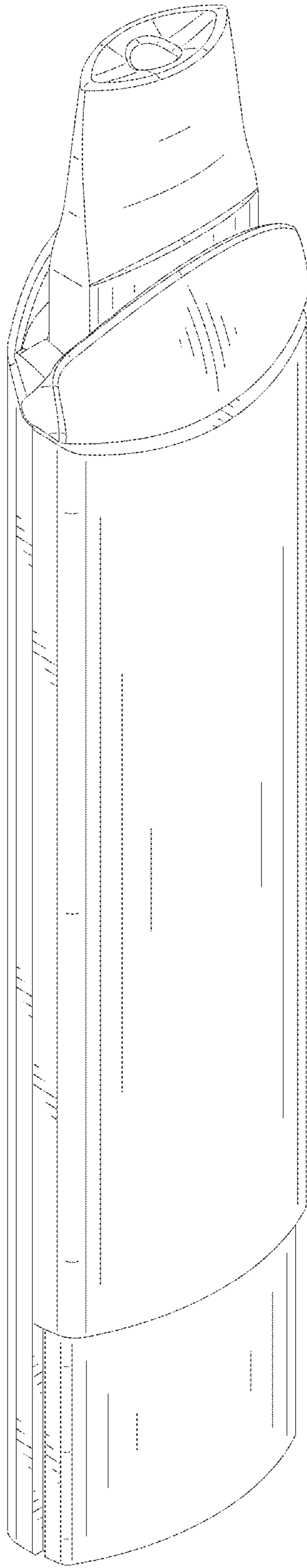

FIG.10

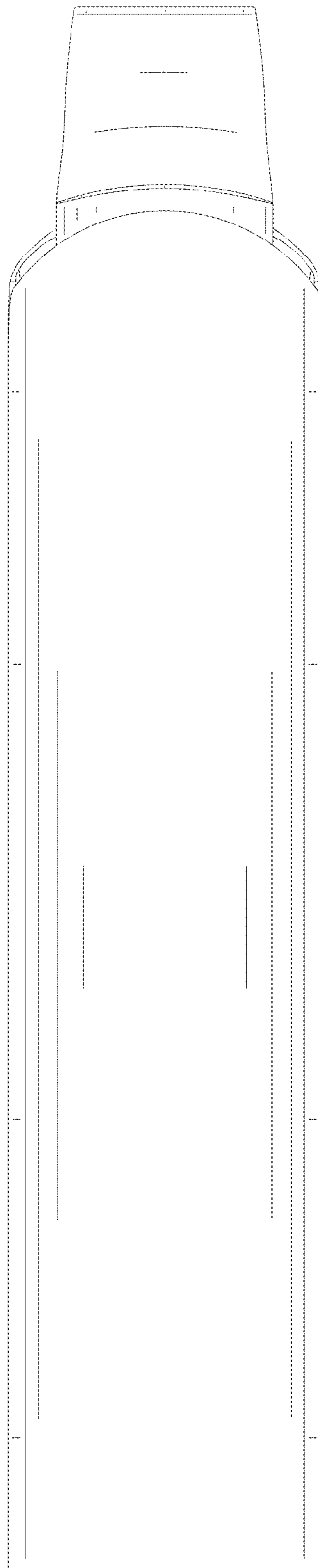

FIG.11

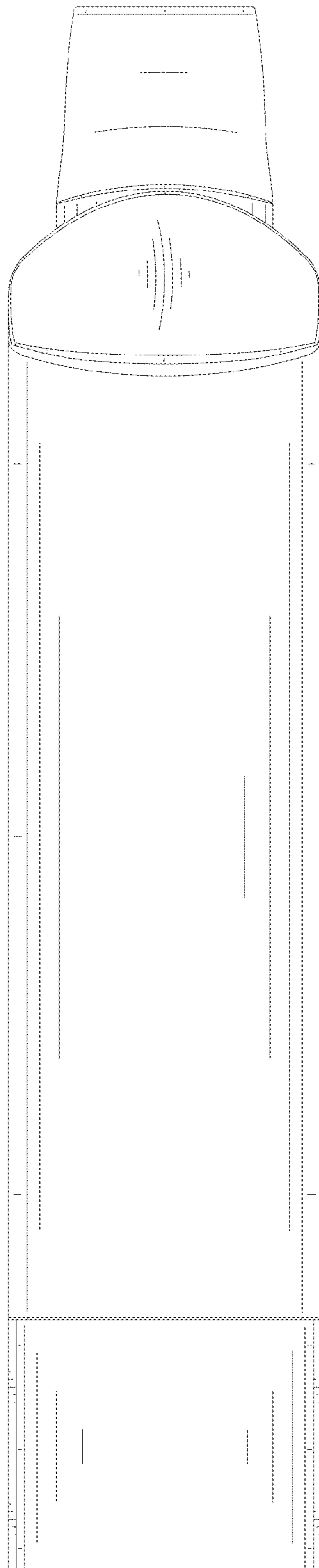

FIG.12

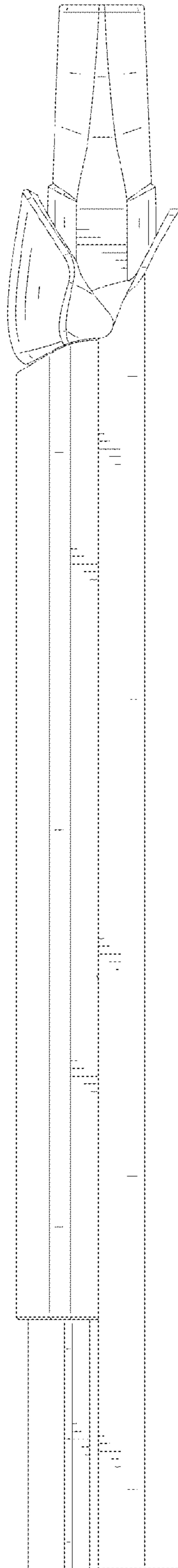

FIG.13

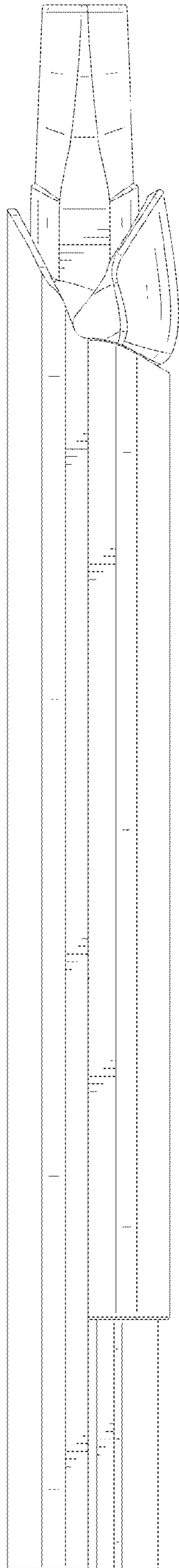

FIG.14

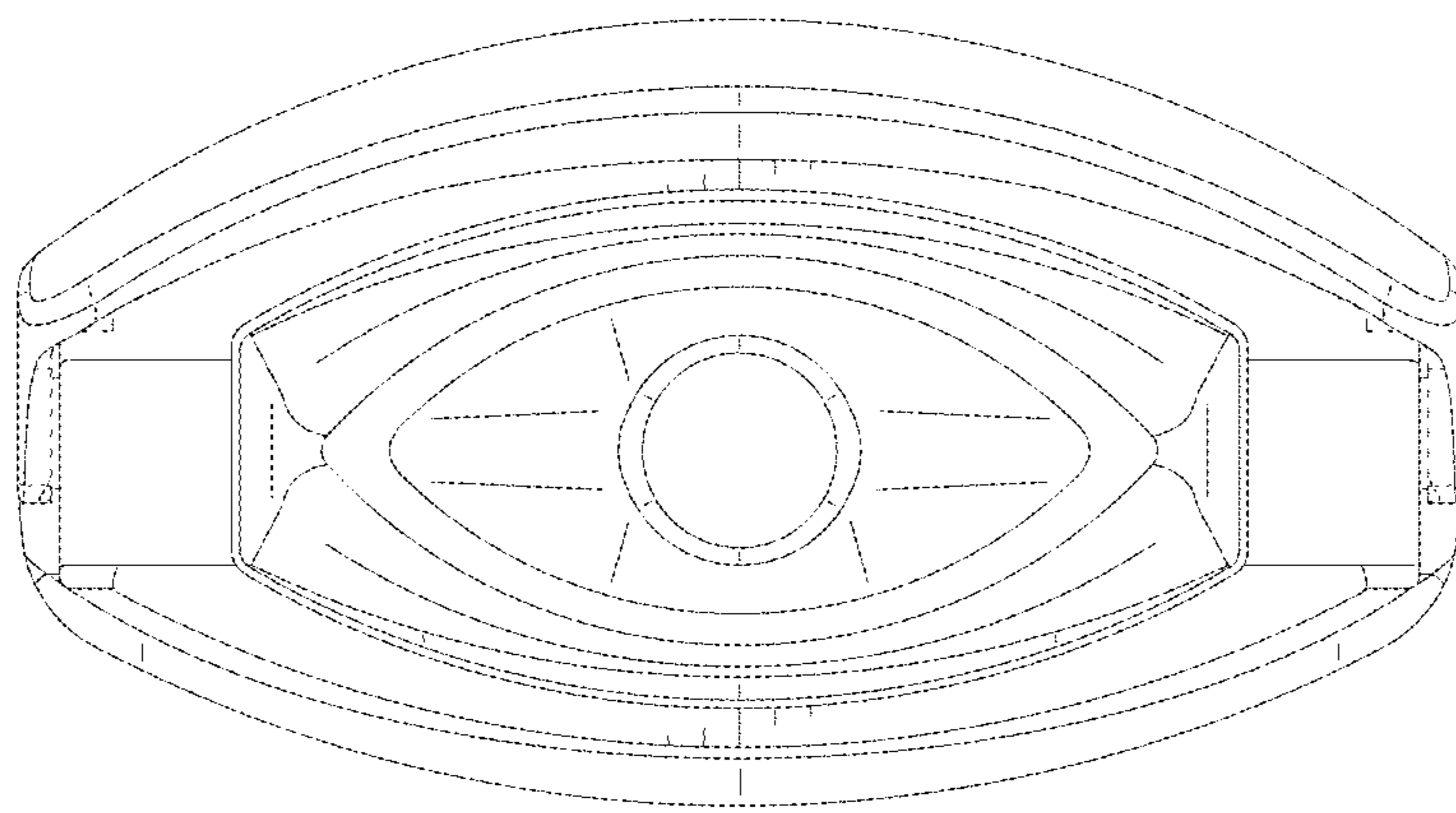

FIG.15

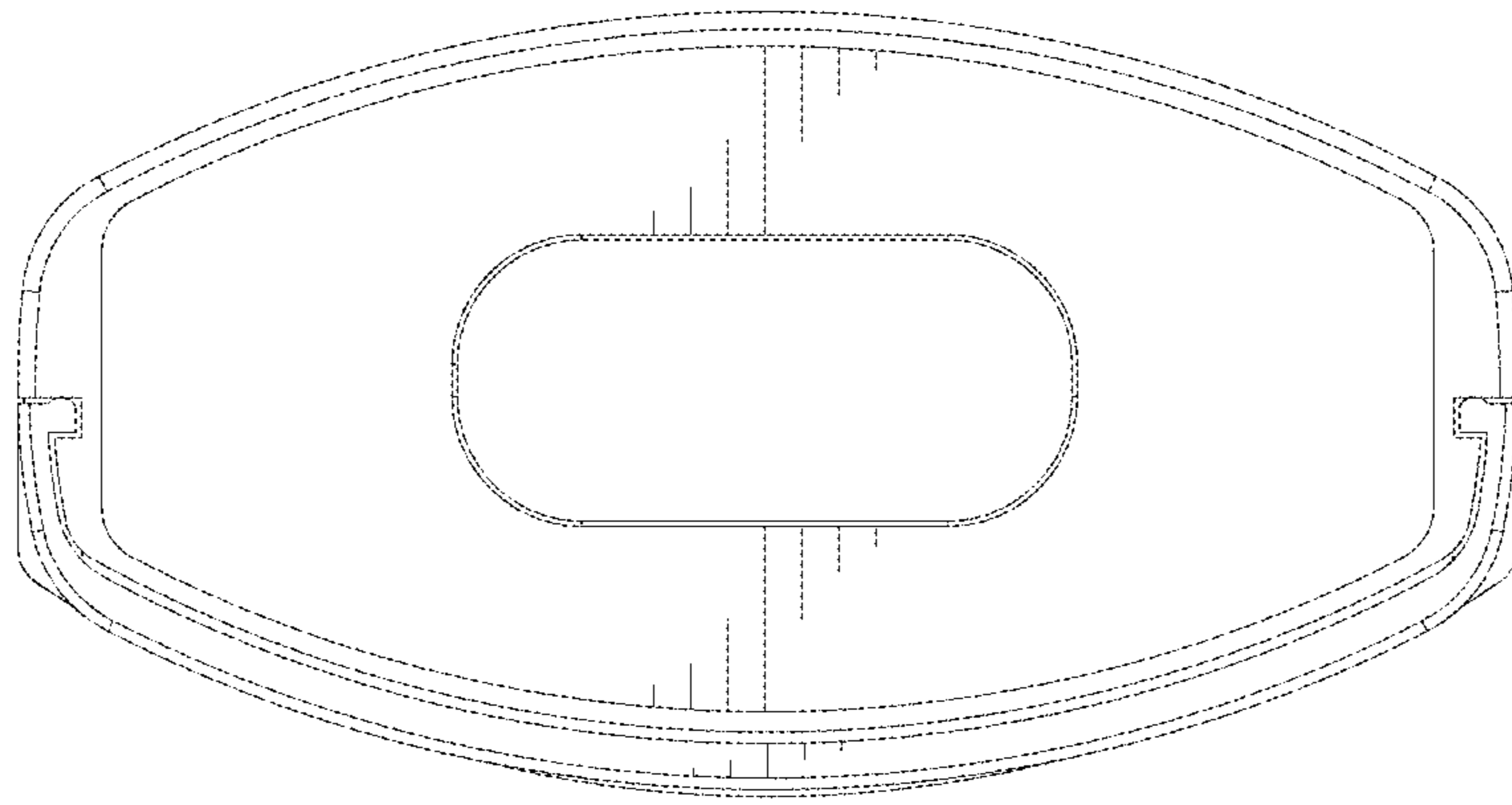

FIG.16