



US00D909496S

(12) **United States Design Patent**
Zou

(10) **Patent No.:** **US D909,496 S**

(45) **Date of Patent:** **** Feb. 2, 2021**

(54) **MOBILE ROBOT**

(71) Applicant: **SHANTOU CITY AHEAD TOYS CO., LTD**, Shantou (CN)

(72) Inventor: **Wei Zou**, Shantou (CN)

(73) Assignee: **SHANTOU CITY AHEAD TOYS CO., LTD**, Shantou (CN)

(**) Term: **15 Years**

(21) Appl. No.: **29/697,354**

(22) Filed: **Jul. 8, 2019**

(51) **LOC (13) Cl.** **21-02**

(52) **U.S. Cl.**
USPC **D21/578**

(58) **Field of Classification Search**
USPC D21/578–583, 621–622; D15/199;
D16/203
CPC B25J 9/0006; B25J 9/0009; B25J 9/0003;
B25J 9/00

See application file for complete search history.

(56) **References Cited**

U.S. PATENT DOCUMENTS

D298,766 S *	11/1988	Tanno	D21/578
D464,090 S *	10/2002	Hornsby	D21/578
D464,382 S *	10/2002	Hornsby	D21/578
D471,243 S *	3/2003	Cioffi	D21/578
7,766,716 B2 *	8/2010	Fong	A63H 3/16 446/99
D639,353 S *	6/2011	Stibolt	D21/578
D695,345 S *	12/2013	Park	D19/59
D713,477 S *	9/2014	Lee	D15/199

D725,167 S *	3/2015	Song	D15/199
D761,894 S *	7/2016	Ho	D15/199
D838,758 S *	1/2019	Kymm	D15/199
D857,117 S *	8/2019	Venancio	D21/533
D868,907 S *	12/2019	Liu	D21/578

OTHER PUBLICATIONS

“Yingtesi Stem Educational Smart Robots Toys for Kids” Oct. 23, 2018, Amazon.com, site visited Jun. 19, 2020: <https://www.amazon.com/dp/B07H7KNT4Z/>(Year: 2018).*

* cited by examiner

Primary Examiner — Michael C Stout

Assistant Examiner — Melvin L Davis

(74) *Attorney, Agent, or Firm* — Muncy, Geissler, Olds & Lowe, P.C.

(57) **CLAIM**

The ornamental design for a mobile robot, as shown and described.

DESCRIPTION

FIG. 1 is a front elevational view of a mobile robot showing my new design;

FIG. 2 is a rear elevational view thereof;

FIG. 3 is a left side view thereof;

FIG. 4 is a right side view thereof;

FIG. 5 is a top plan view thereof;

FIG. 6 is a bottom plan view thereof; and,

FIG. 7 is a perspective view thereof.

The broken lines illustrate environment structure which forms no part of the claimed design.

1 Claim, 7 Drawing Sheets

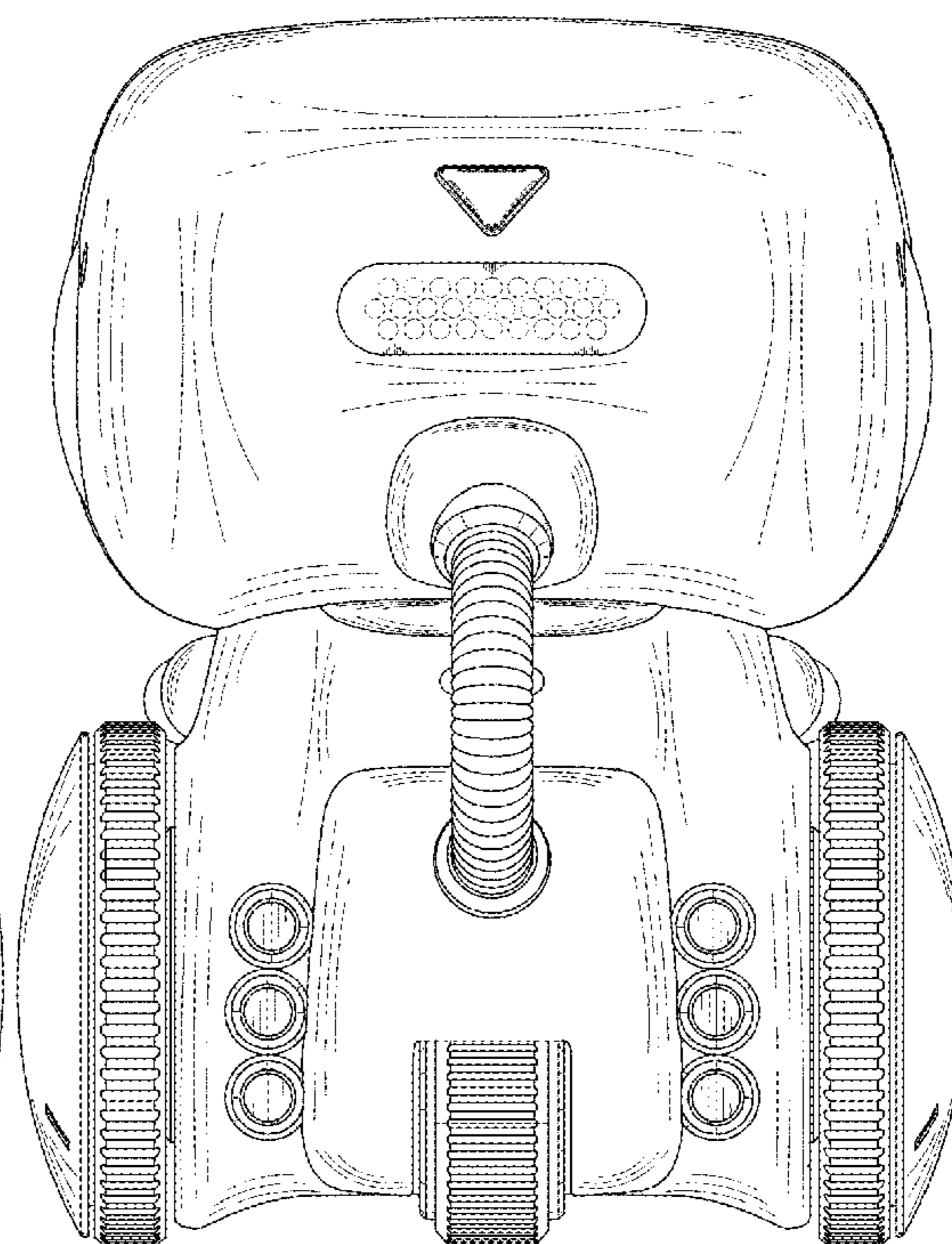
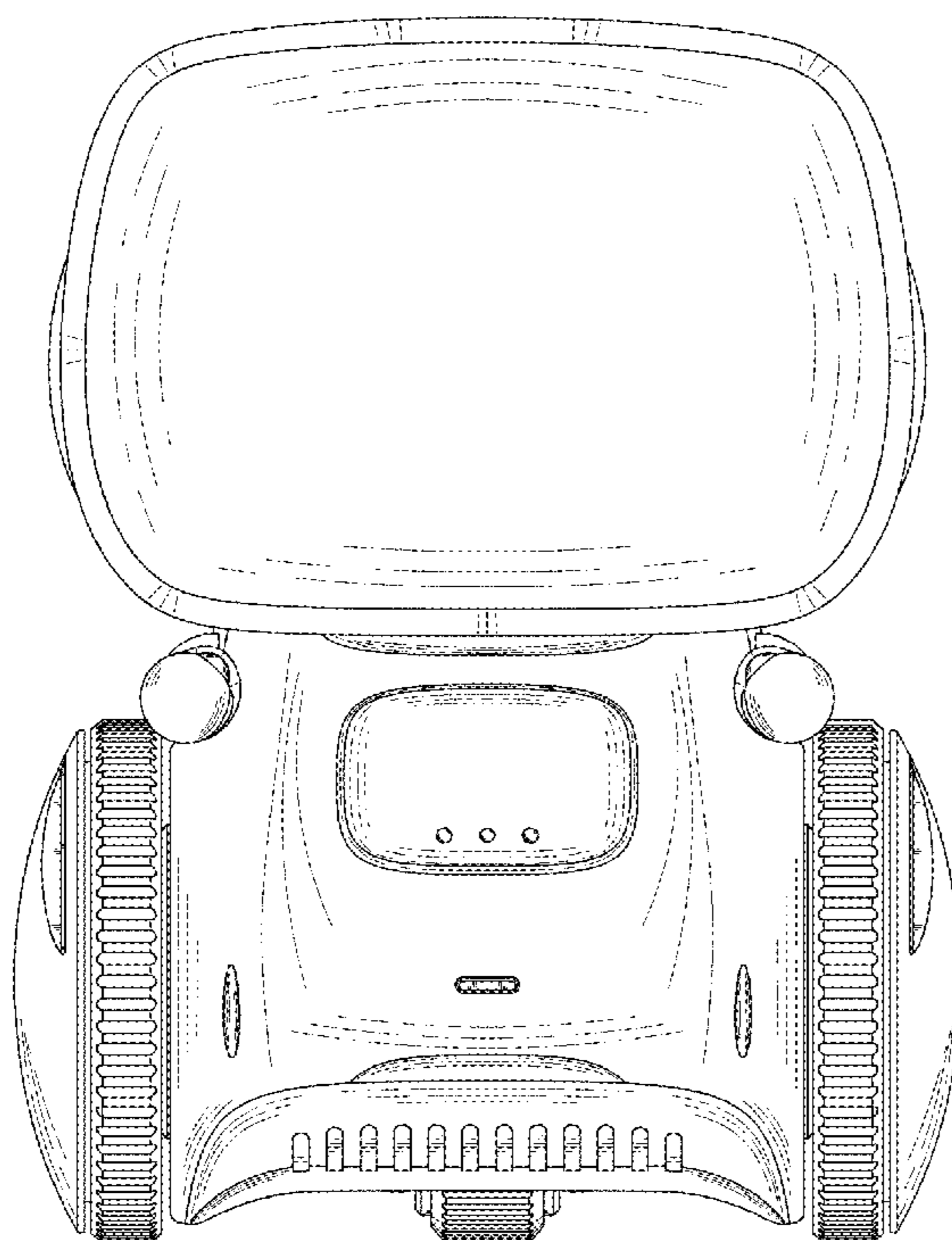

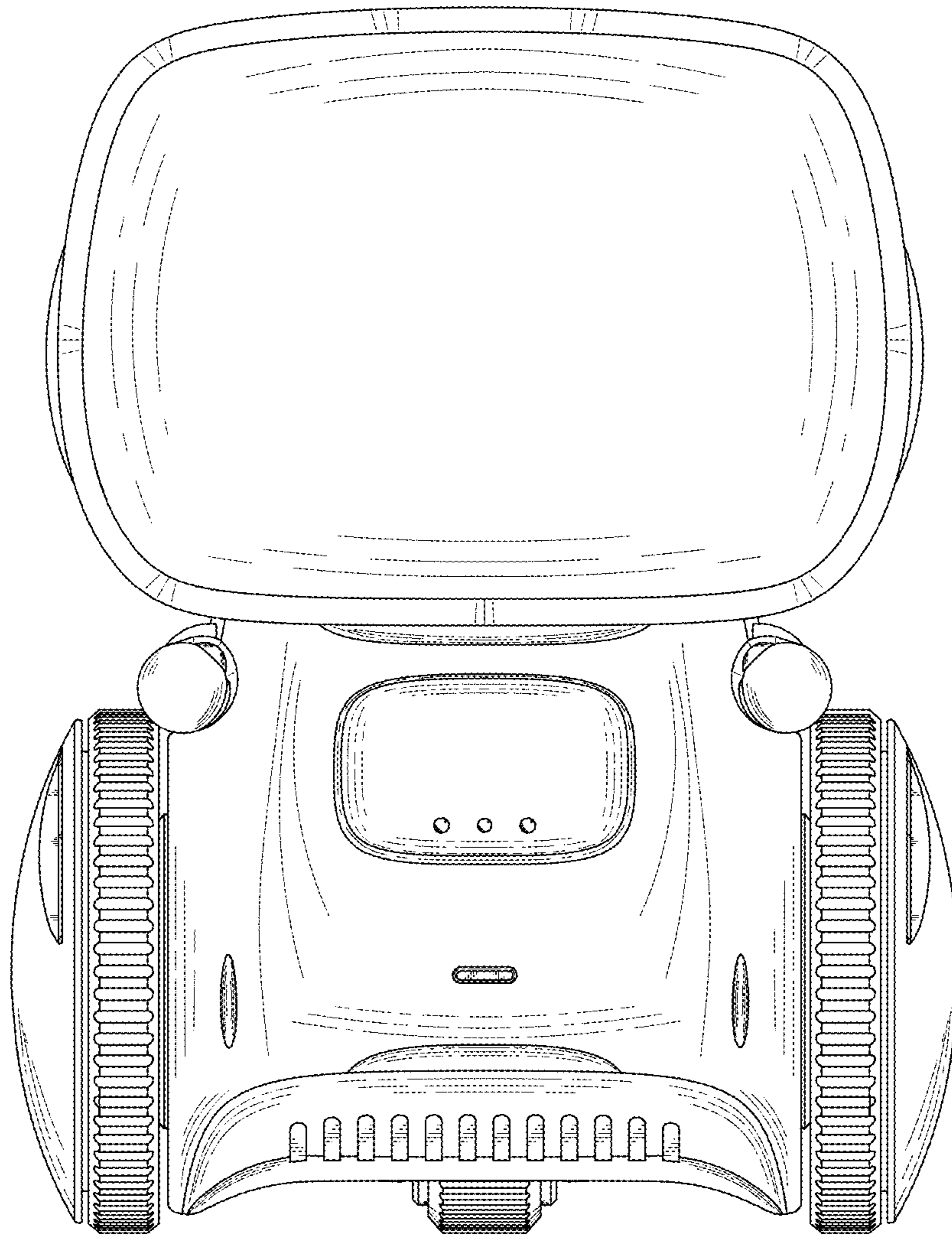

Fig. 1

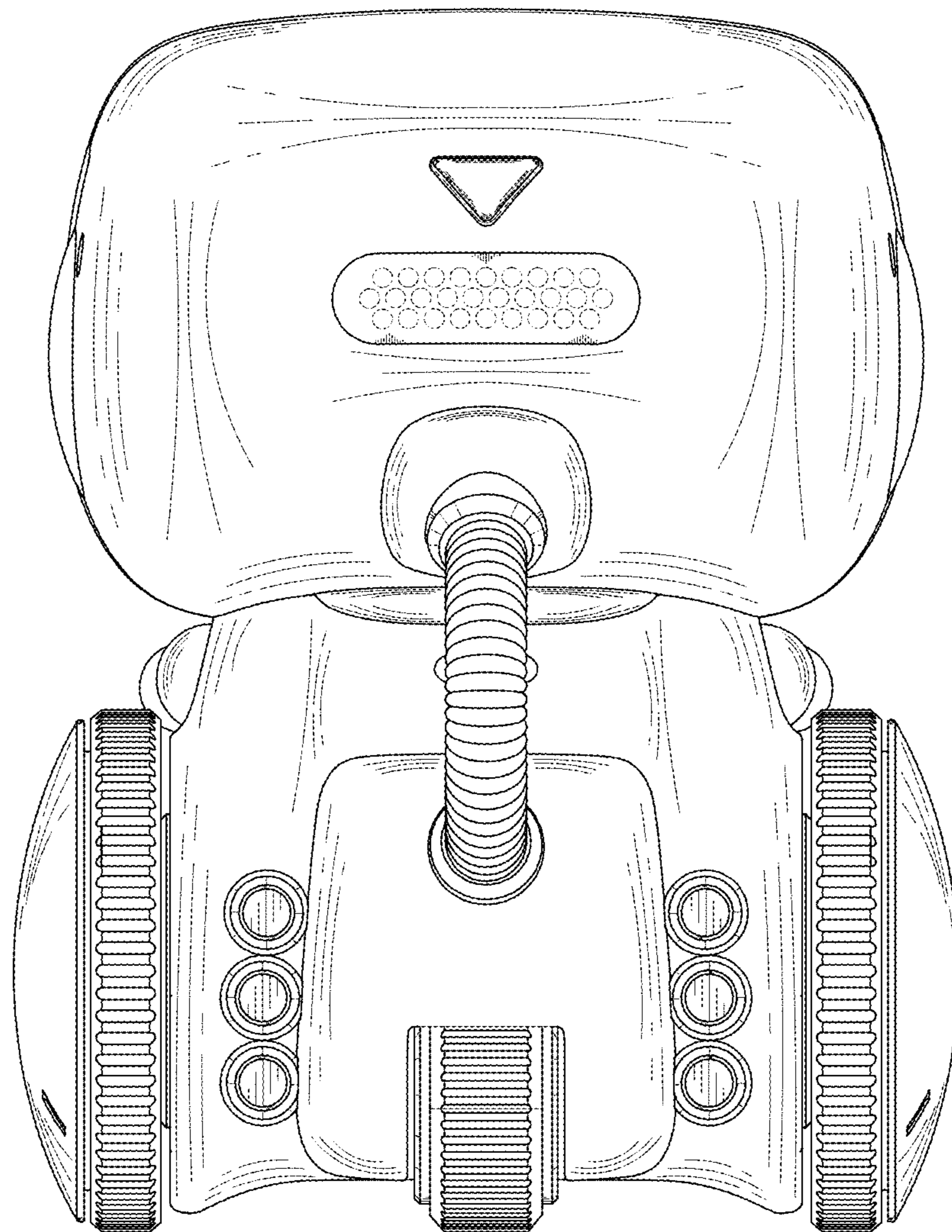

Fig.2

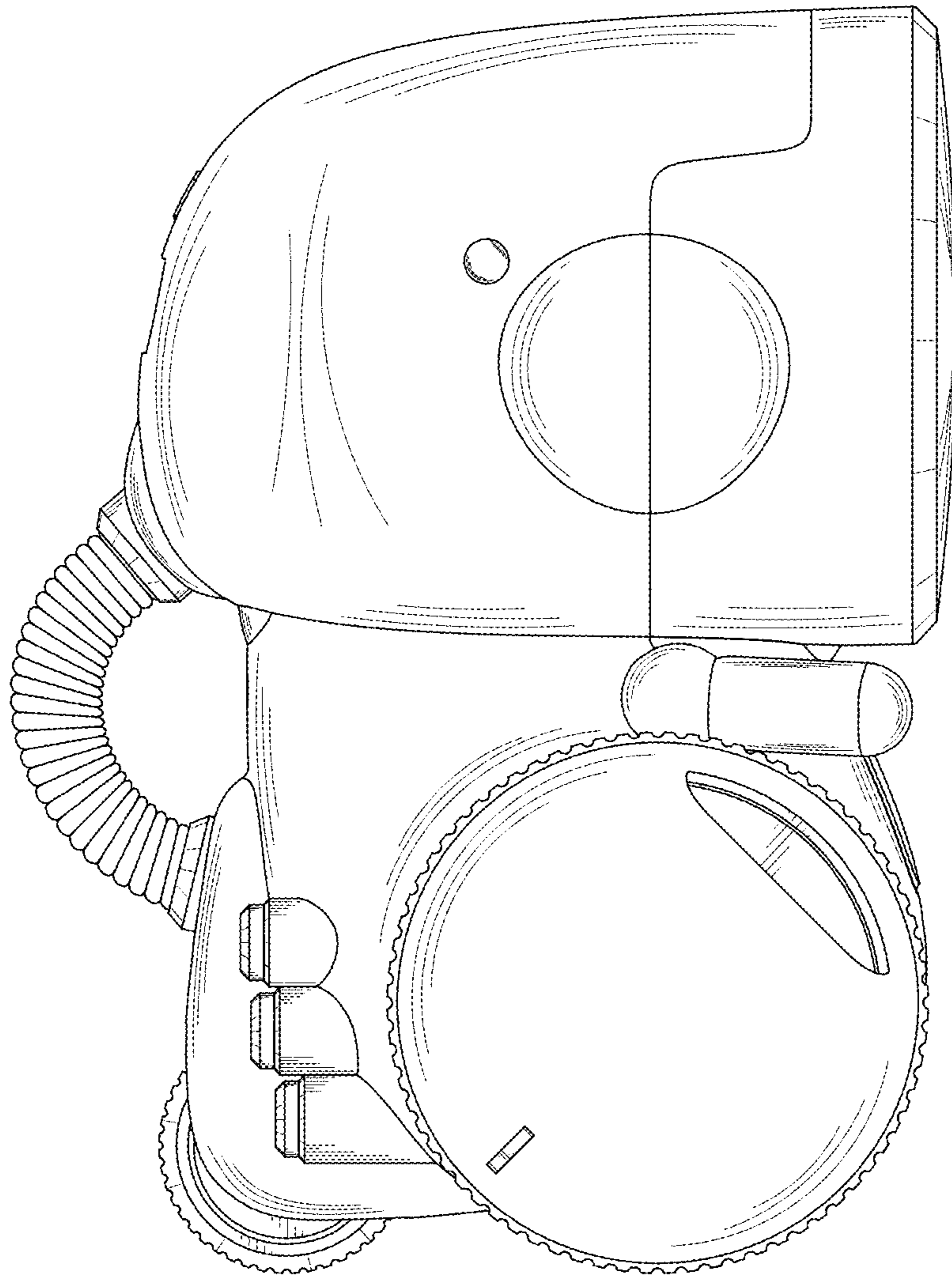

Fig.3

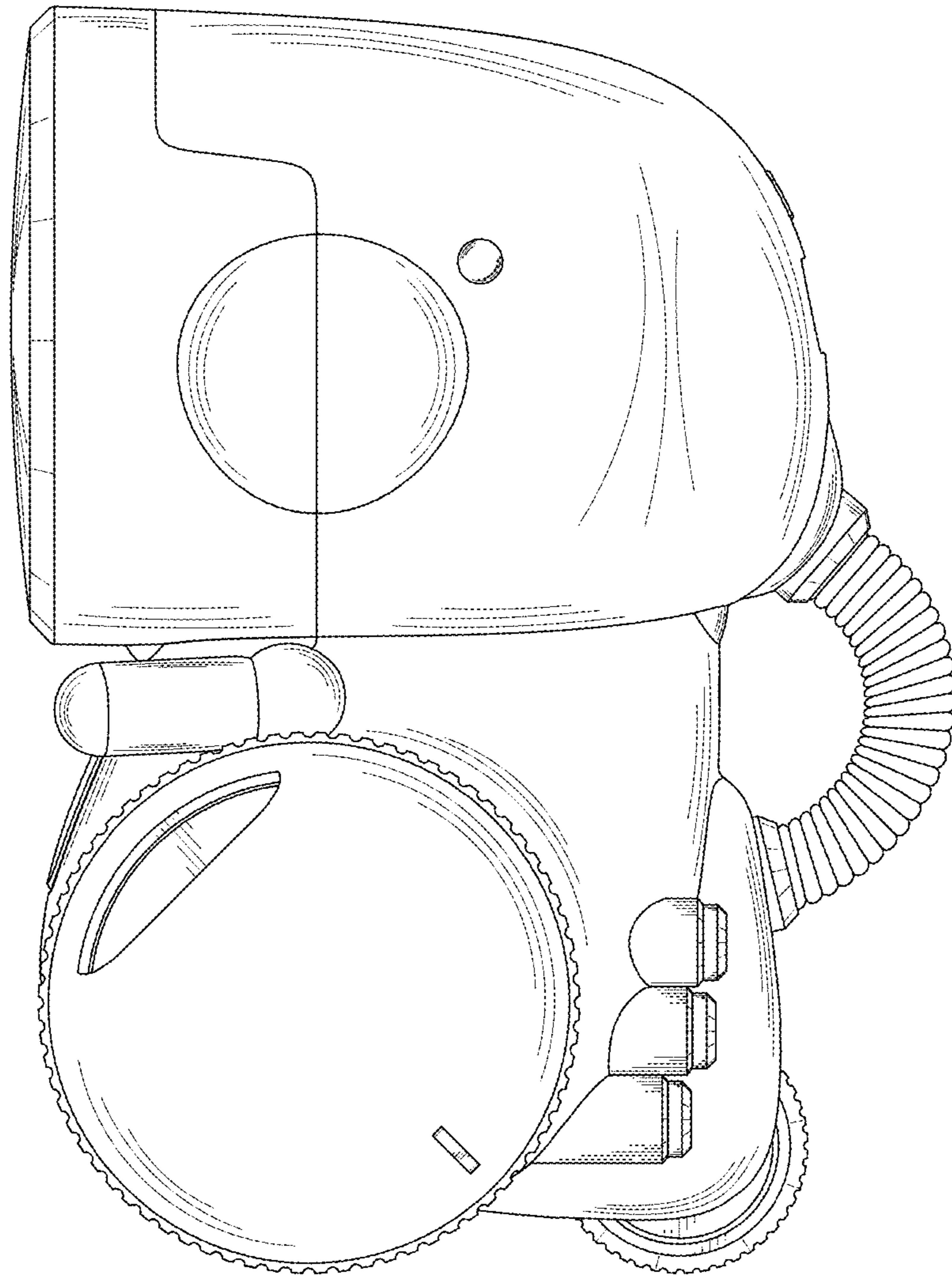

Fig.4

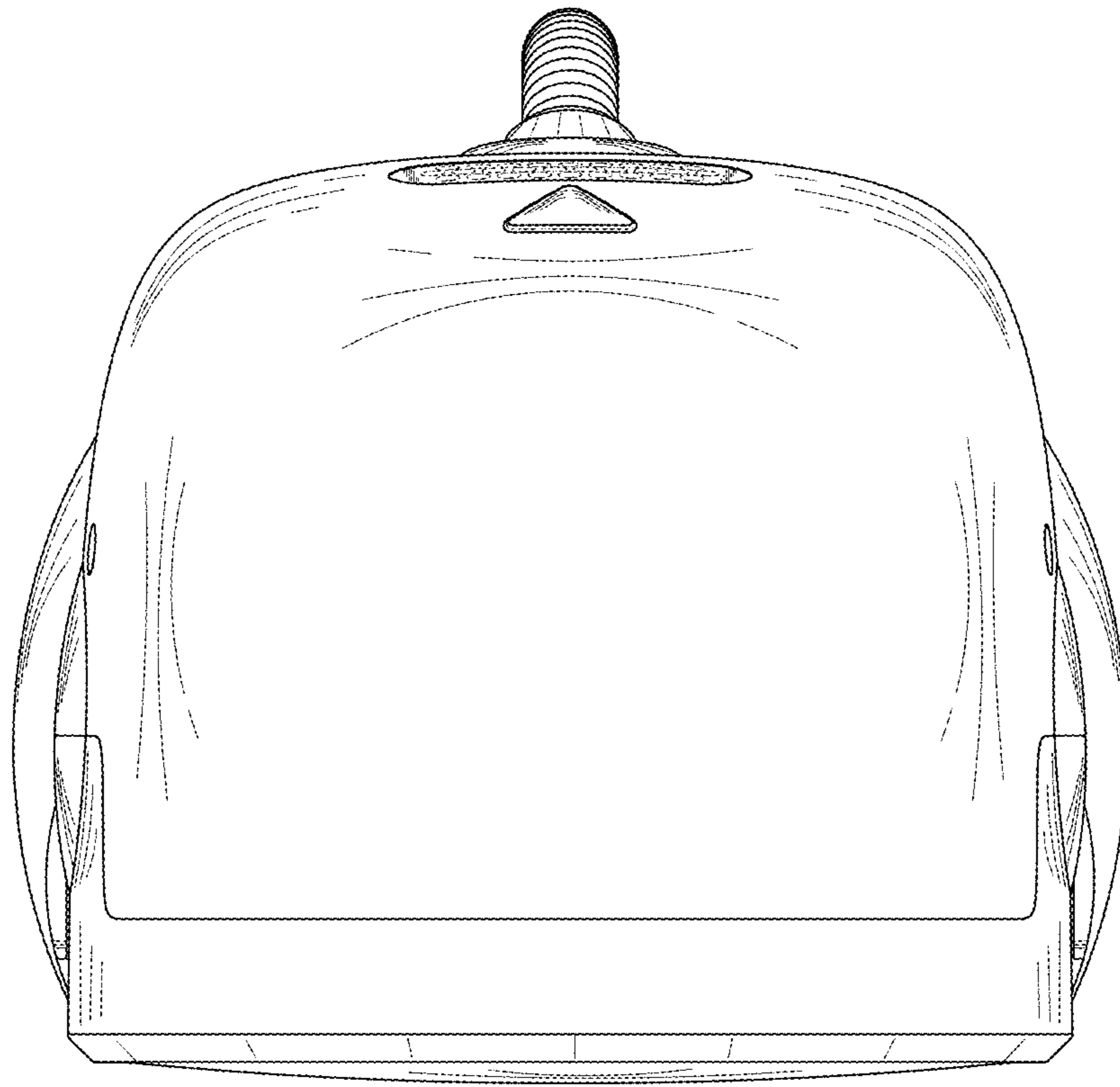

Fig.5

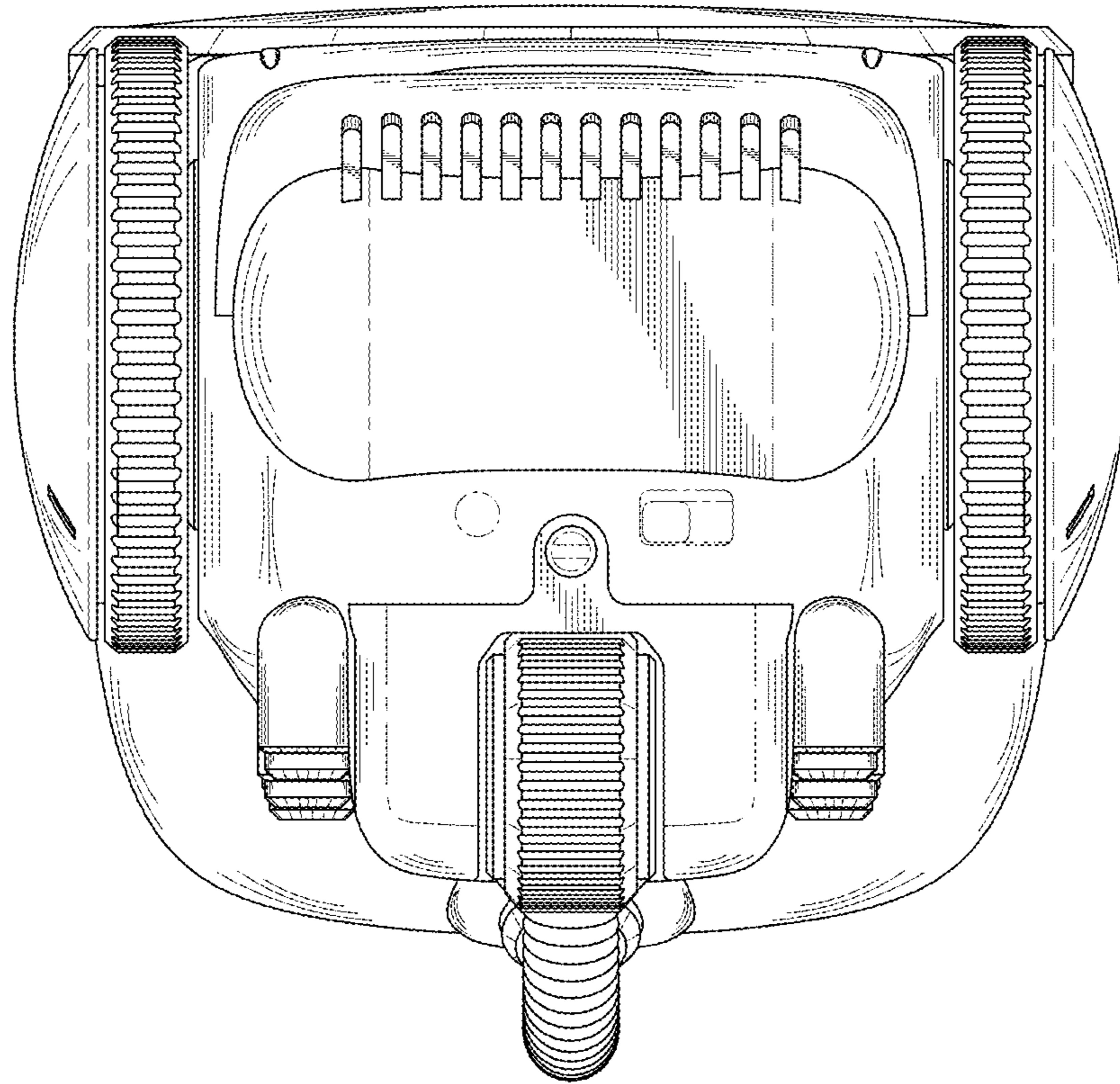

Fig. 6

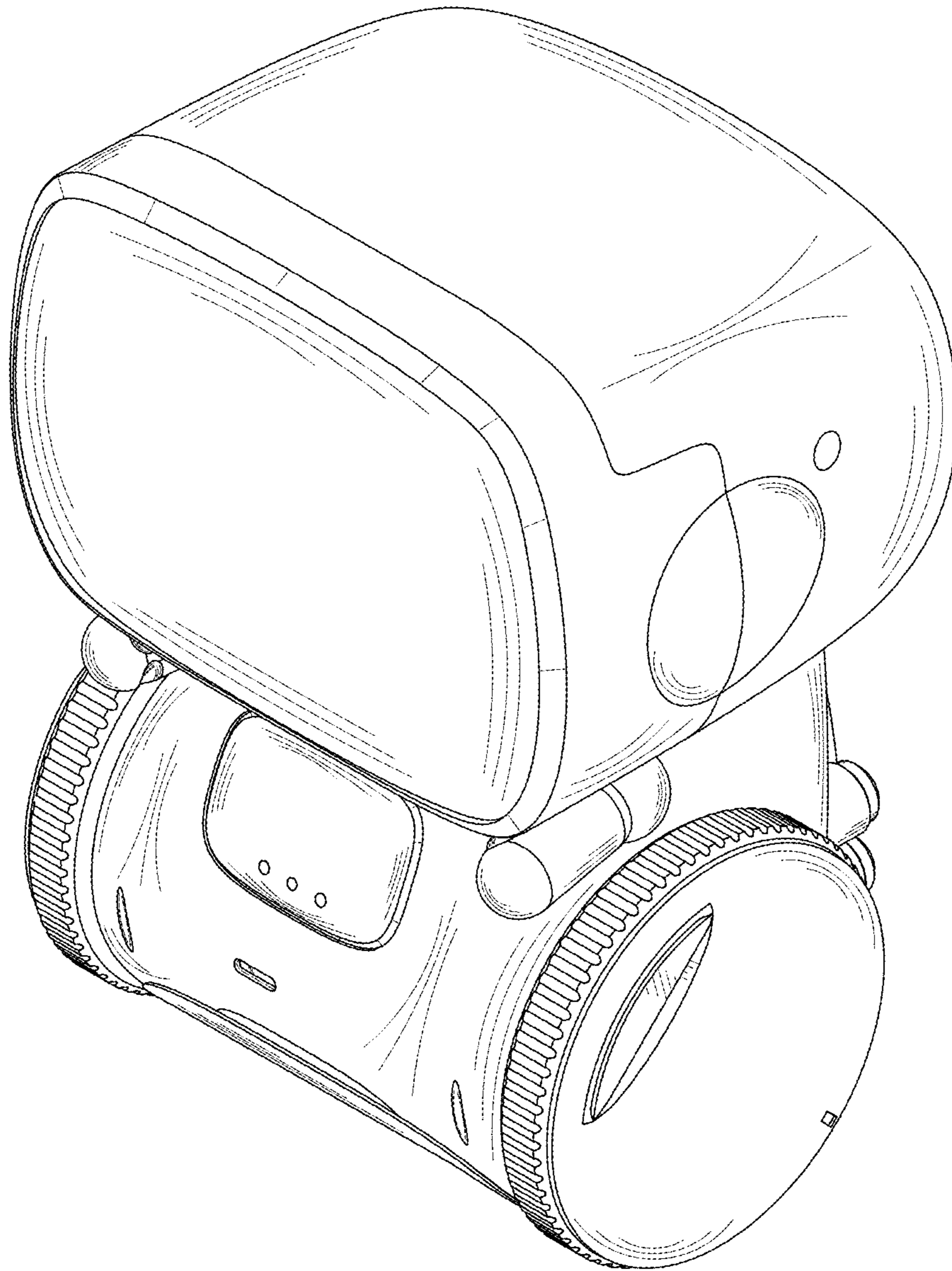

Fig. 7