



US00D909484S

(12) **United States Design Patent**
Whitaker et al.

(10) **Patent No.:** **US D909,484 S**

(45) **Date of Patent:** **** Feb. 2, 2021**

(54) **CONTROLLER**

D784,989 S 4/2017 Kujawski et al.
D794,129 S 8/2017 Kujawski et al.
D872,185 S 1/2020 Chatterjee et al.

(71) Applicant: **Microsoft Corporation**, Redmond, WA
(US)

OTHER PUBLICATIONS

(72) Inventors: **Ryan Eugene Whitaker**, Seattle, WA
(US); **Cory William Bloomquist**,
Vancouver, WA (US)

U.S. Appl. No. 29/716,478, filed Dec. 10, 2019.
U.S. Appl. No. 29/716,442, filed Dec. 10, 2019.
U.S. Appl. No. 29/716,445, filed Dec. 10, 2019.
U.S. Appl. No. 29/716,472, filed Dec. 10, 2019.
U.S. Appl. No. 29/716,462, filed Dec. 10, 2019.
U.S. Appl. No. 29/716,465, filed Dec. 10, 2019.

(73) Assignee: **Microsoft Corporation**, Redmond, WA
(US)

(**) Term: **15 Years**

* cited by examiner

(21) Appl. No.: **29/716,455**

Primary Examiner — Sandra L Morris

(22) Filed: **Dec. 10, 2019**

(74) *Attorney, Agent, or Firm* — Banner & Witcoff, Ltd.

(51) **LOC (13) Cl.** **21-01**

(57) **CLAIM**

(52) **U.S. Cl.**

The ornamental design for a controller, as shown and described.

USPC **D21/333**; D14/401

(58) **Field of Classification Search**

DESCRIPTION

USPC D14/218, 400–401, 417, 454–457;
D21/333

CPC A63F 13/22; A63F 13/24; A63F 13/40;
A63F 13/42; A63F 13/98; G06F 3/0338

See application file for complete search history.

FIG. 1 is a front perspective view of a controller showing our new design;

FIG. 2 is a front view thereof;

FIG. 3 is a rear view thereof;

FIG. 4 is a top view thereof;

FIG. 5 is a bottom view thereof;

FIG. 6 is a left side view thereof; and,

FIG. 7 is a right side view thereof.

The broken lines depicting the remainder of the controller in FIGS. 1-7 show features that form no part of the claimed design.

(56) **References Cited**

U.S. PATENT DOCUMENTS

D522,012 S * 5/2006 Hayes D21/333
D561,190 S * 2/2008 Goto D21/333
D646,275 S * 10/2011 Ikeda D21/333
D709,498 S 7/2014 Morris et al.
D709,499 S 7/2014 Morris et al.
D709,882 S 7/2014 Morris et al.
D784,987 S 4/2017 Kujawski

1 Claim, 7 Drawing Sheets

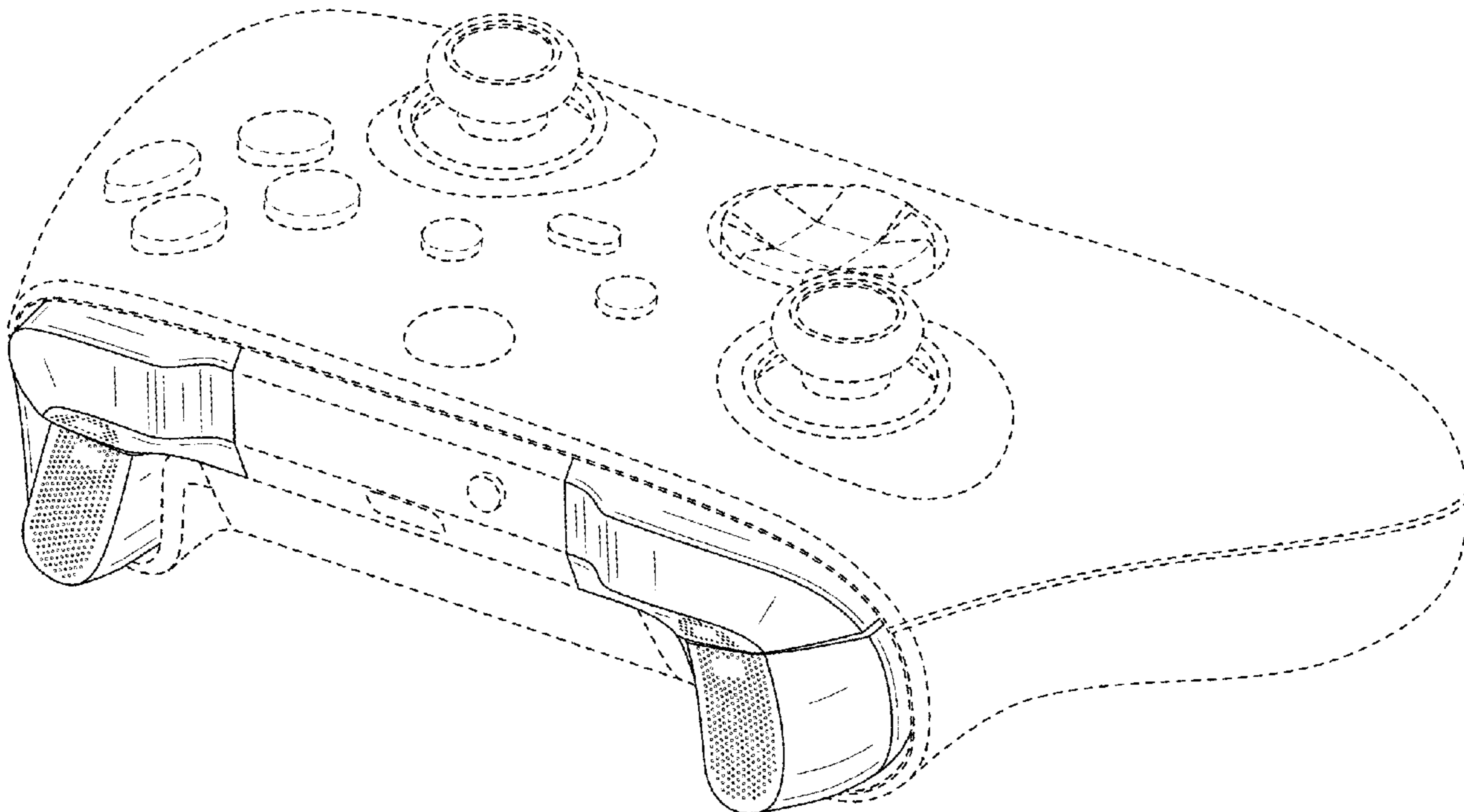

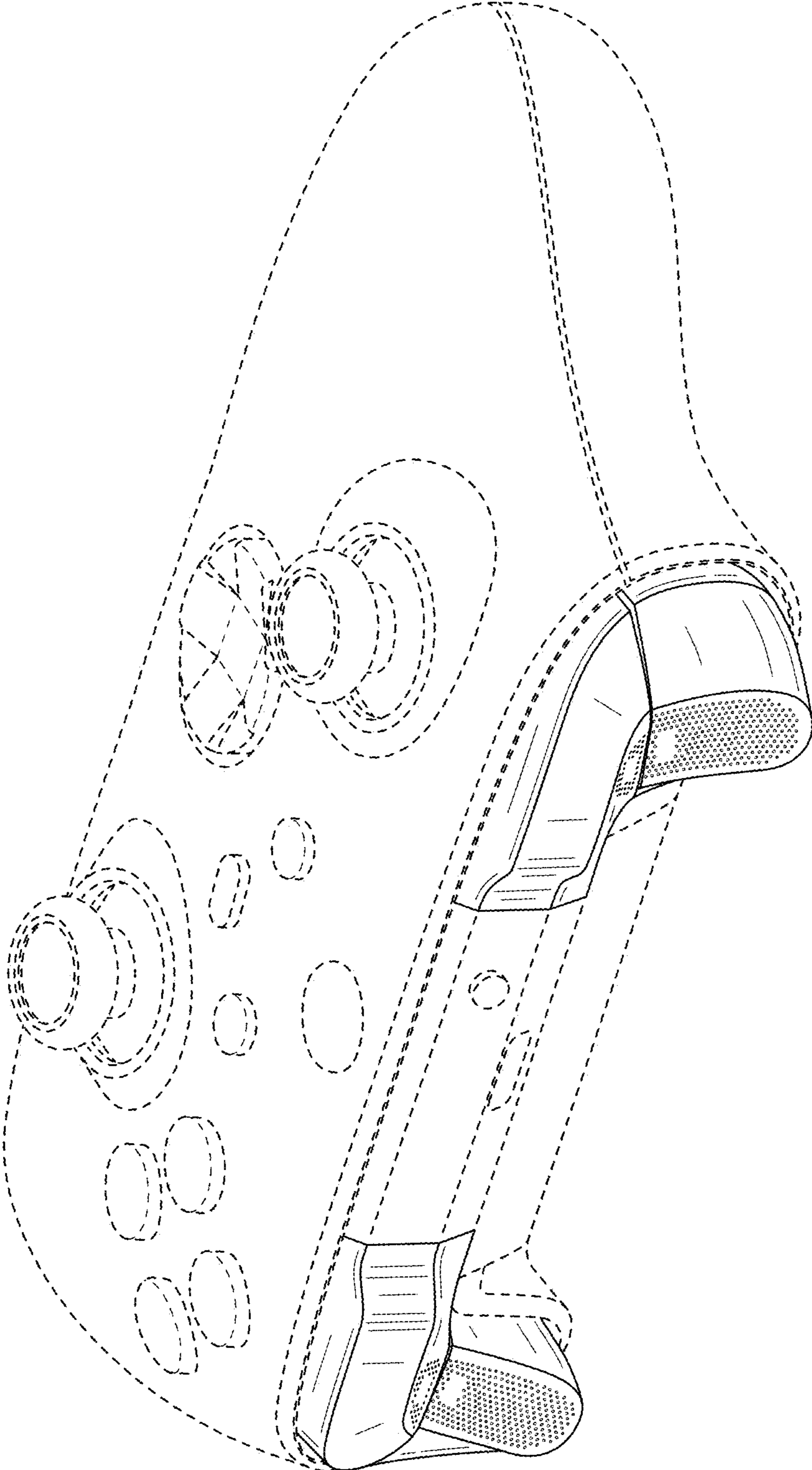

FIG. 1

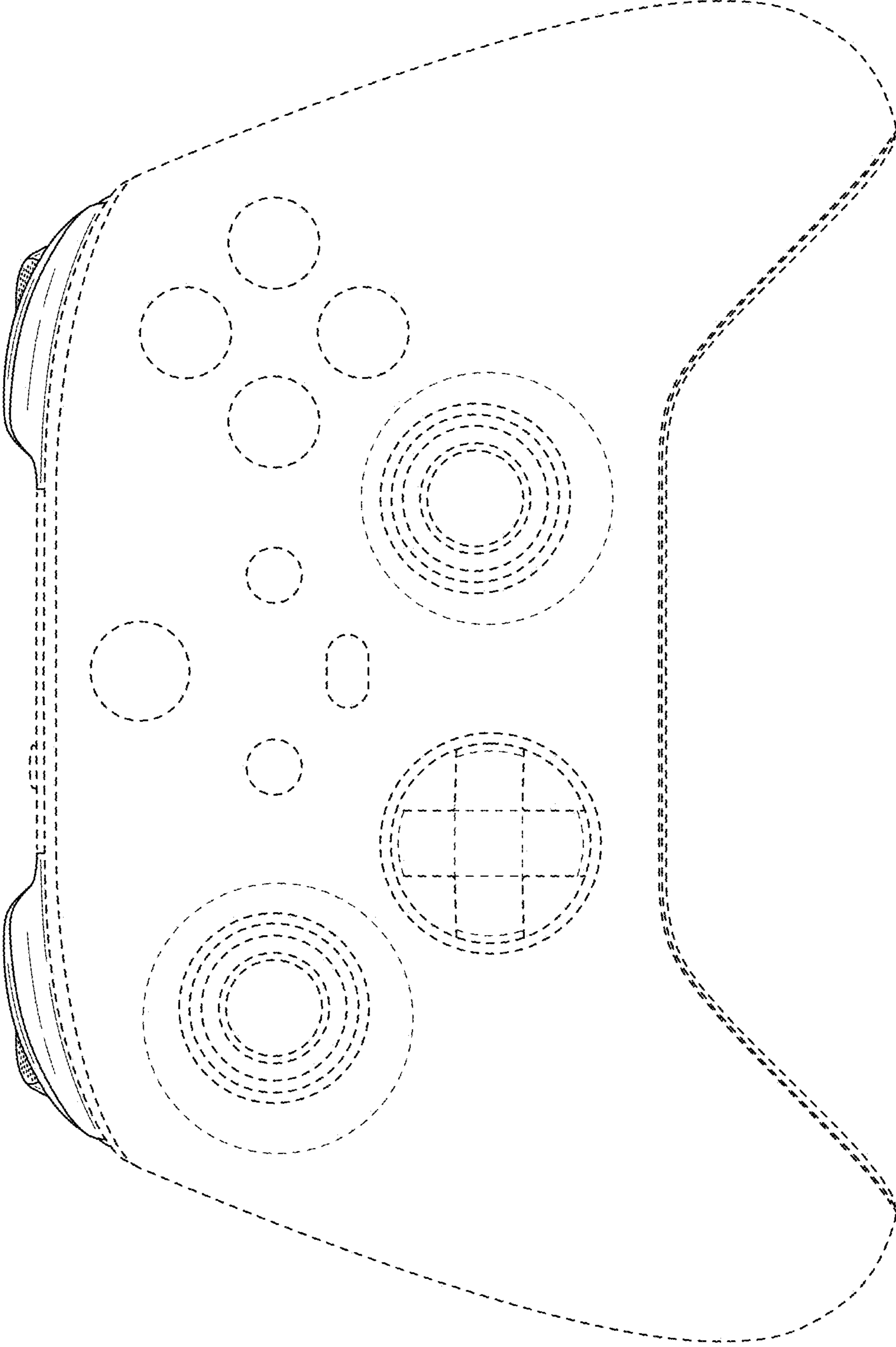

FIG. 2

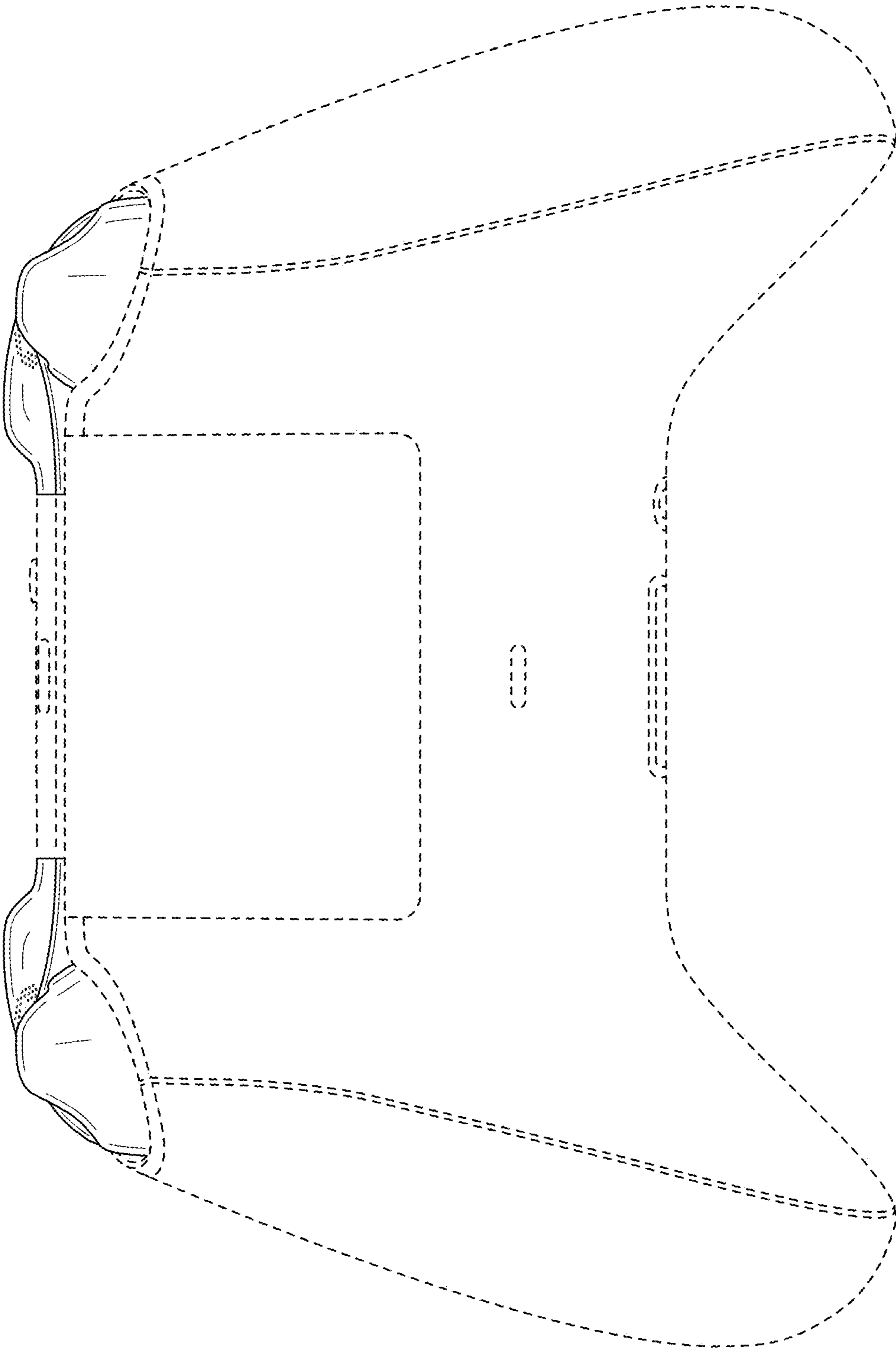

FIG. 3

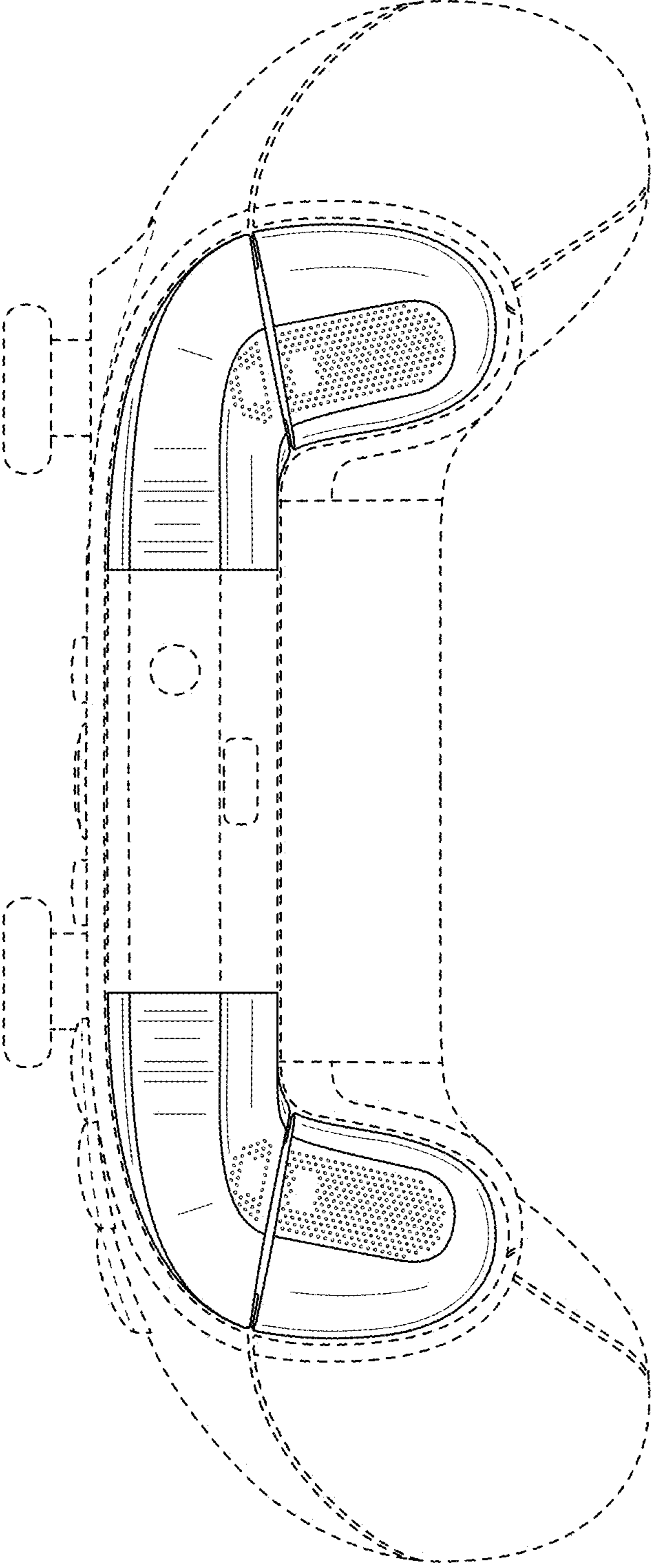

FIG. 4

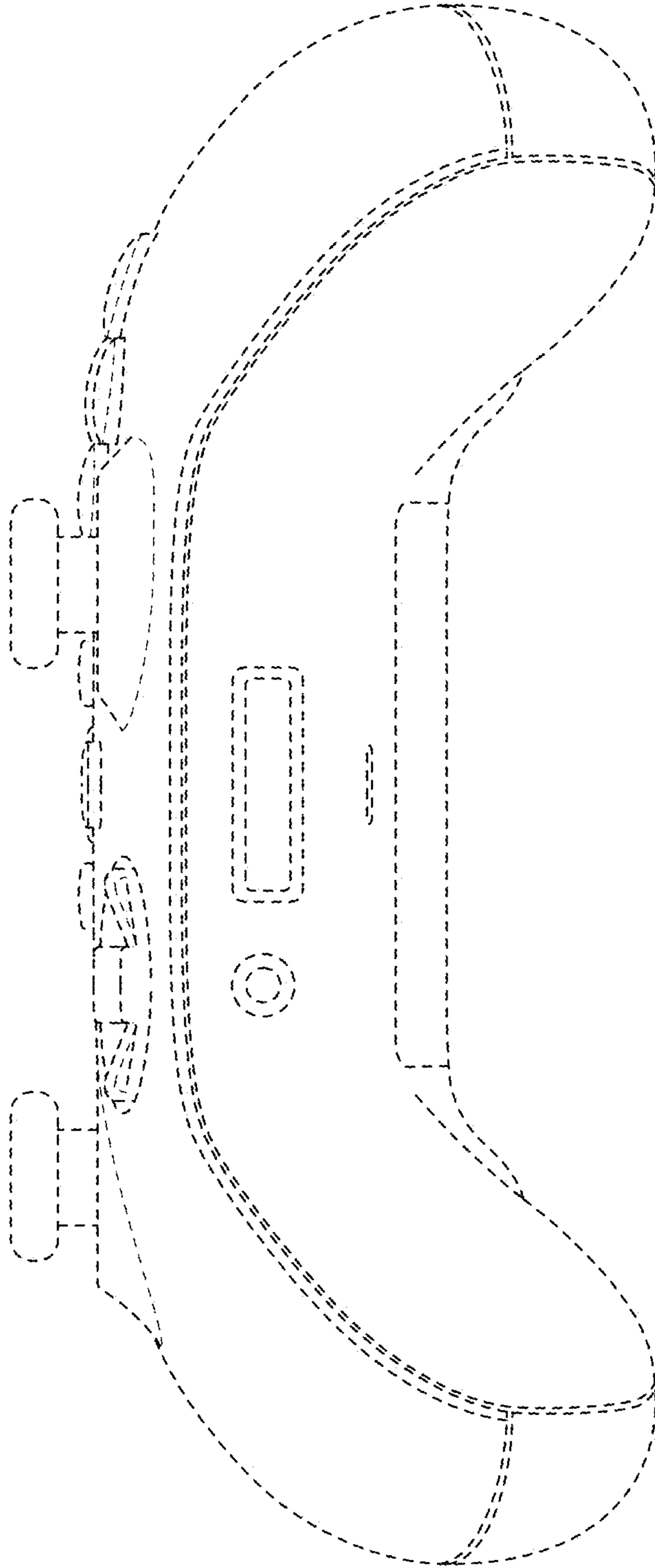

FIG. 5

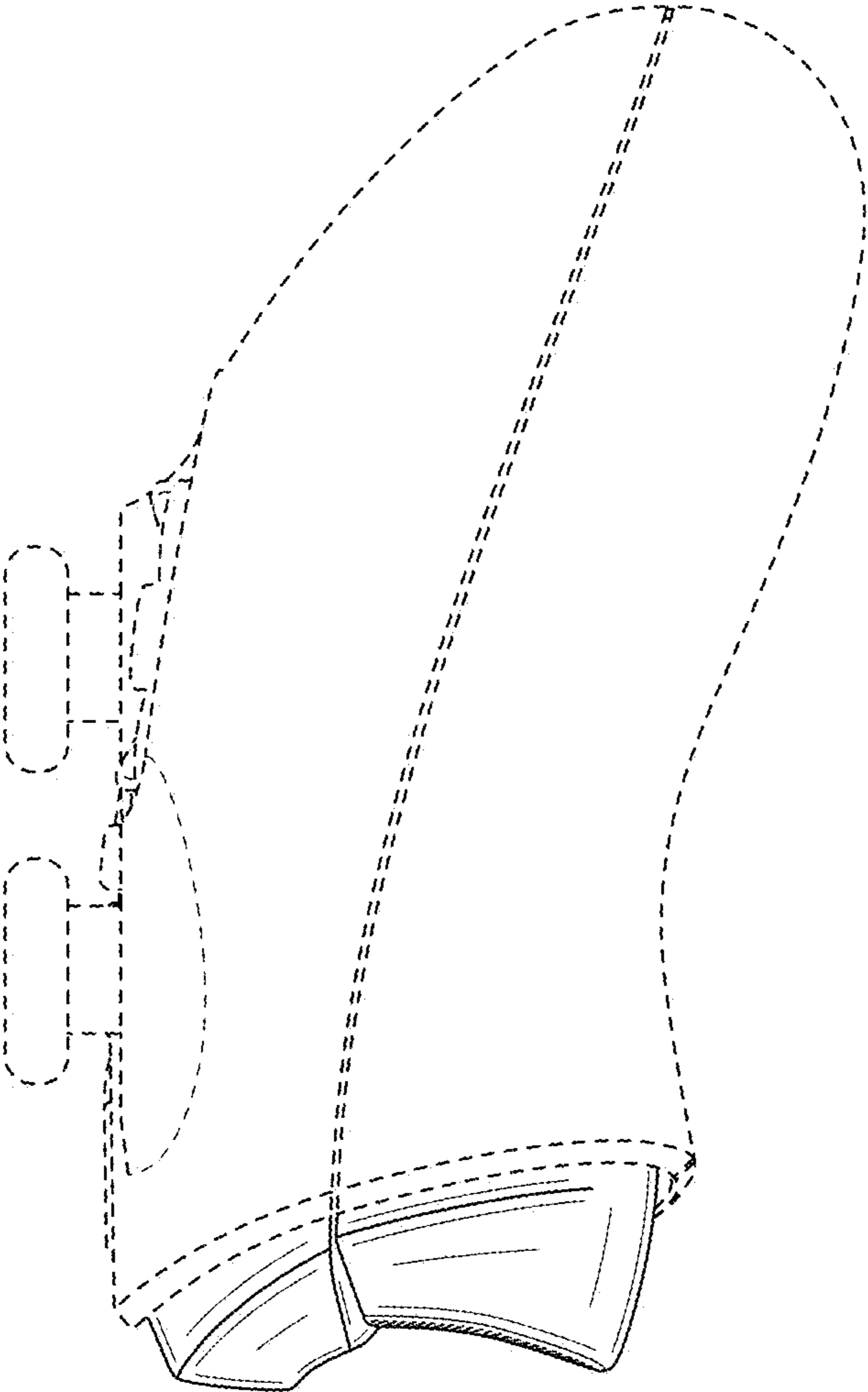

FIG. 6

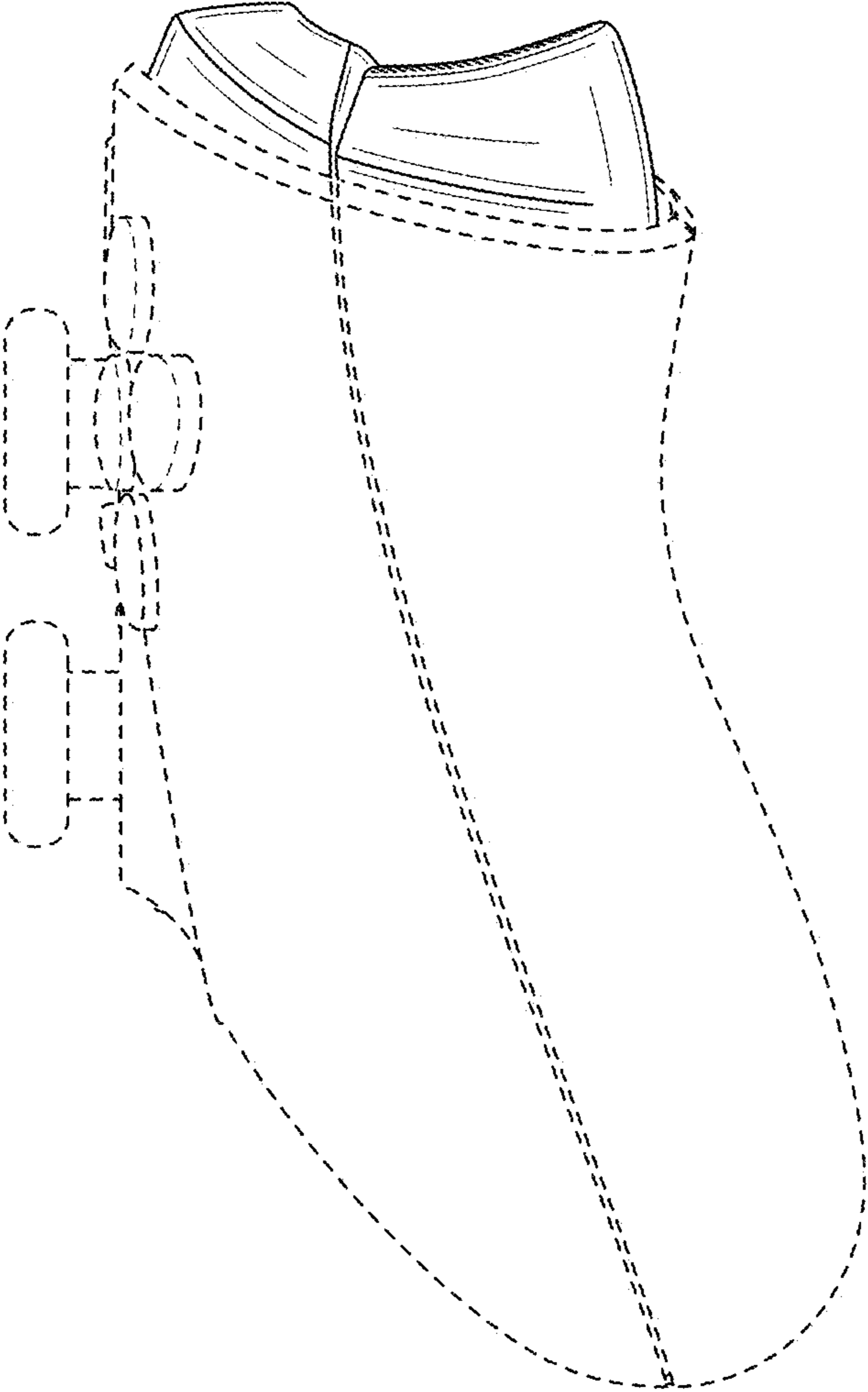

FIG. 7