



US00D909431S

(12) **United States Design Patent** (10) **Patent No.:** **US D909,431 S**
Kim et al. (45) **Date of Patent:** **** *Feb. 2, 2021**

(54) **REFRIGERATOR** 2,322,626 A * 6/1943 Gerhard F25D 11/02
62/71
(71) Applicant: **SAMSUNG ELECTRONICS CO., LTD.**, Suwon-si (KR) D169,431 S * 4/1953 Ferar D15/88
D171,129 S * 12/1953 Goodson D19/24
(Continued)

(72) Inventors: **Hyunsoo Kim**, Seongnam-si (KR);
Youngmin Park, Seoul (KR)

(73) Assignee: **SAMSUNG ELECTRONICS CO., LTD.**, Gyeonggi-Do (KR)

(*) Notice: This patent is subject to a terminal disclaimer.

(**) Term: **15 Years**

(21) Appl. No.: **29/676,069**

(22) Filed: **Jan. 8, 2019**

(30) **Foreign Application Priority Data**

Jul. 9, 2018 (KR) 30-2018-0031538

(51) **LOC (13) Cl.** **15-07**

(52) **U.S. Cl.**
USPC **D15/79**; D15/81

(58) **Field of Classification Search**
USPC D15/71-91; 62/340, 344, 382, 407, 448;
312/287, 402
CPC F25D 11/003; F25D 11/02; F25D 11/022;
F25D 13/06; F25D 19/006; F25D 29/00;
F25D 29/005; F25D 29/008; F25D
2201/14; F25D 2323/00261; F25D
2323/00262; F25D 2323/00272; F25D
2400/361; F25D 2500/06; F25D 2700/02;
F25D 2700/08; F25D 2700/12
See application file for complete search history.

(56) **References Cited**

U.S. PATENT DOCUMENTS

D135,274 S * 3/1943 Janes D15/88
D135,275 S * 3/1943 Janes D15/88

FOREIGN PATENT DOCUMENTS

KR 9611894 U 4/1996
KR 9744690 U 7/1997
(Continued)

OTHER PUBLICATIONS

The Antique Refrigerator, Earliest Available Date Oct. 1, 2011 [Online], [Site visited Jun. 11, 2020] Available From Internet, URL:<<http://www.denisbyrne.com/fridge.html>> (Year: 2011).*

(Continued)

Primary Examiner — Sandra Snapp
Assistant Examiner — Donald B Rose, Jr.
(74) *Attorney, Agent, or Firm* — Cantor Colburn LLP

(57) **CLAIM**

The ornamental design for a refrigerator, as shown and described.

DESCRIPTION

FIG. 1 is a left-side front perspective view of a refrigerator, showing our new design;
FIG. 2 is a front view thereof;
FIG. 3 is a rear view thereof;
FIG. 4 is a left-side view thereof;
FIG. 5 is a right-side view thereof;
FIG. 6 is a top view thereof;
FIG. 7 is a bottom view thereof; and,
FIG. 8 is a right-side front perspective view thereof shown in an alternate position in which a door is open.
The broken lines depict portions of the refrigerator that form no part of the claimed design.

1 Claim, 8 Drawing Sheets

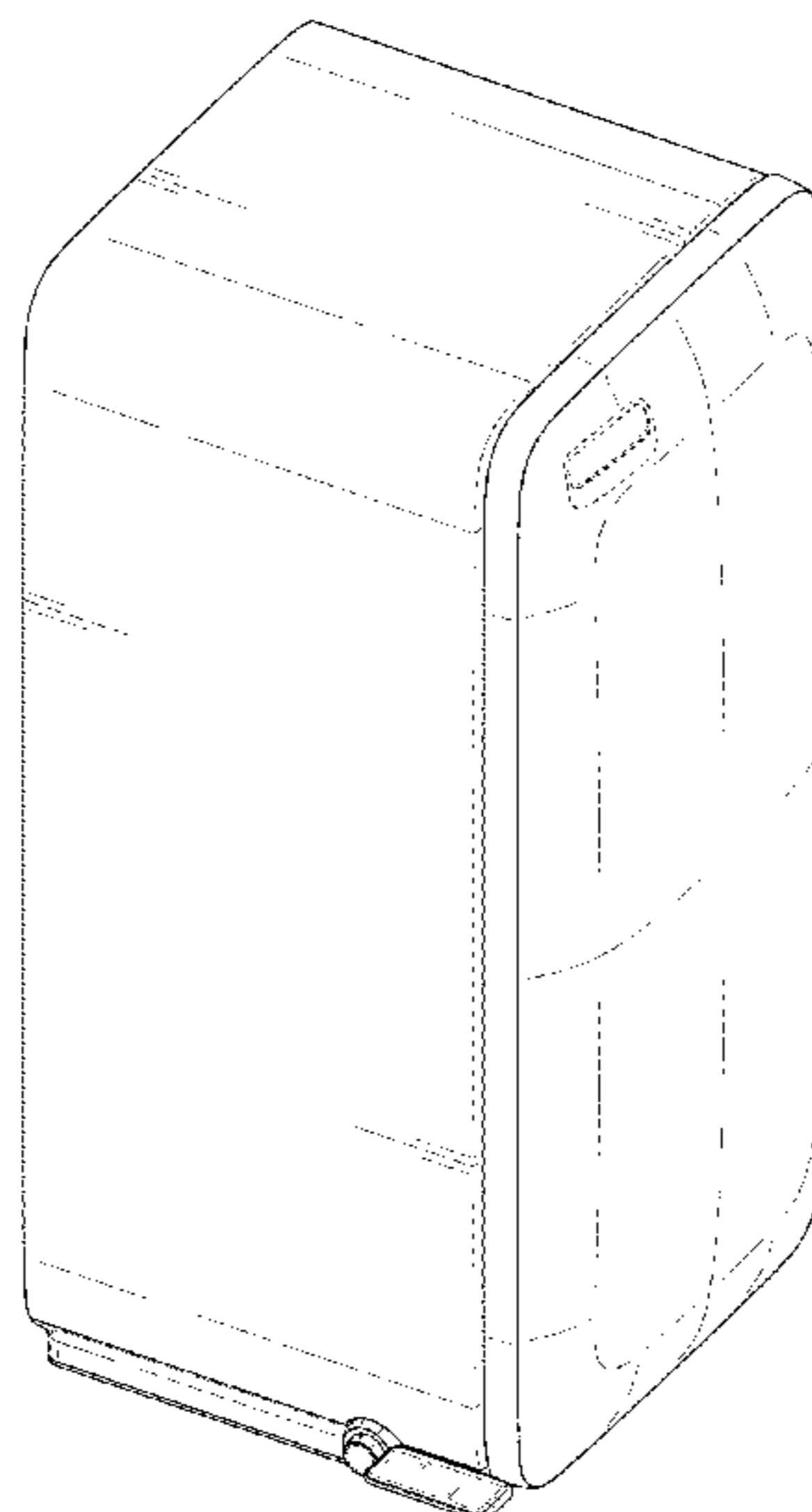

(56)

References Cited

U.S. PATENT DOCUMENTS

2,663,999 A * 12/1953 Alsing F25D 11/02
62/382
D175,647 S * 9/1955 Reynolds, Jr. D15/88
2,717,505 A * 9/1955 Andersson F25D 21/14
62/344
2,720,089 A * 10/1955 Morton F25D 21/14
62/131
2,753,695 A * 7/1956 Maranto F25D 19/00
62/448
2,770,102 A * 11/1956 Roedter F25C 1/04
62/137
2,770,954 A * 11/1956 Jansen F25D 17/045
62/276
2,775,430 A * 12/1956 Norberg F25D 23/04
165/263
D309,122 S * 7/1990 Biemolt D11/145
D803,903 S * 11/2017 Wang D15/88
D821,458 S * 6/2018 Kim D15/81
D825,622 S * 8/2018 Kwon D15/88
D826,292 S * 8/2018 Lee D15/88
D826,293 S * 8/2018 Kwon D15/88
D829,245 S * 9/2018 Kim D15/88
D829,775 S * 10/2018 Kim D15/81
D847,874 S * 5/2019 Kim D15/81
D852,853 S * 7/2019 Kim D15/81
D853,454 S * 7/2019 Kim D15/81
D886,164 S * 6/2020 Mangiarotti D15/81

D888,109 S * 6/2020 Kim D15/79
D888,112 S * 6/2020 Kim D15/89
2012/0060540 A1* 3/2012 Yang F25C 5/22
62/340

FOREIGN PATENT DOCUMENTS

KR 1999003643 U 1/1999
KR 300701985 S 7/2013
KR 300893921 S 2/2017

OTHER PUBLICATIONS

Daewoo FR-044RCNM Retro Compact Refrigerator 4.4 Cu. Ft. | Mint Green, First Available Date May 17, 2016 [Online], [Site visited Jun. 11, 2020] Available From Internet, URL: <Amazon.com, URL in PDF> (Year: 2016).
17.8 Cu. Ft. All Refrigerator, Approximate Review Date Dec. 31, 2018 [Online], [Site visited Jun. 11, 2020] Available From Internet, URL: <https://www.gladiatorgarageworks.com/products/17-8-cu-ft-all-refrigerator> (Year: 2018).
1959 Frigidaire Fridge, Bottom Freezer. [online]. pp. 1-2 [retrieved on Jan. 2, 2019]. Retrieved from the Internet: <URL: http://www.automaticwasher.org/cgi-bin/TD/TD-VIEWTHREAD.cgi?53187.
Under the Ice. FREON12 (R-12) Refrigerant GAS [online]. pp. 1-3 [retrieved on Jan. 2, 2019]. Retrieved from the Internet: <URL: http://freon12museum.blogspot.kr/.

* cited by examiner

FIG. 1

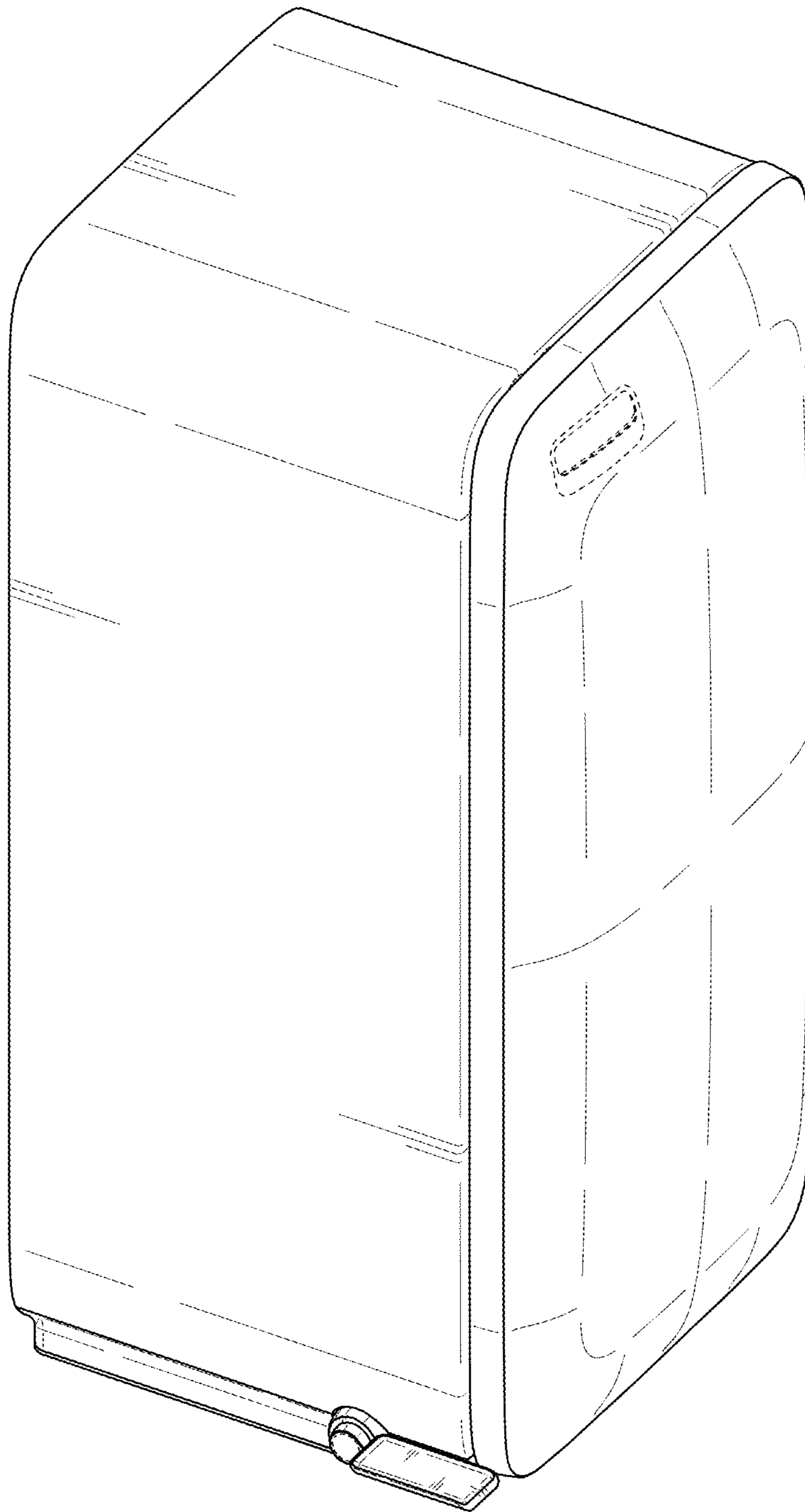

FIG. 2

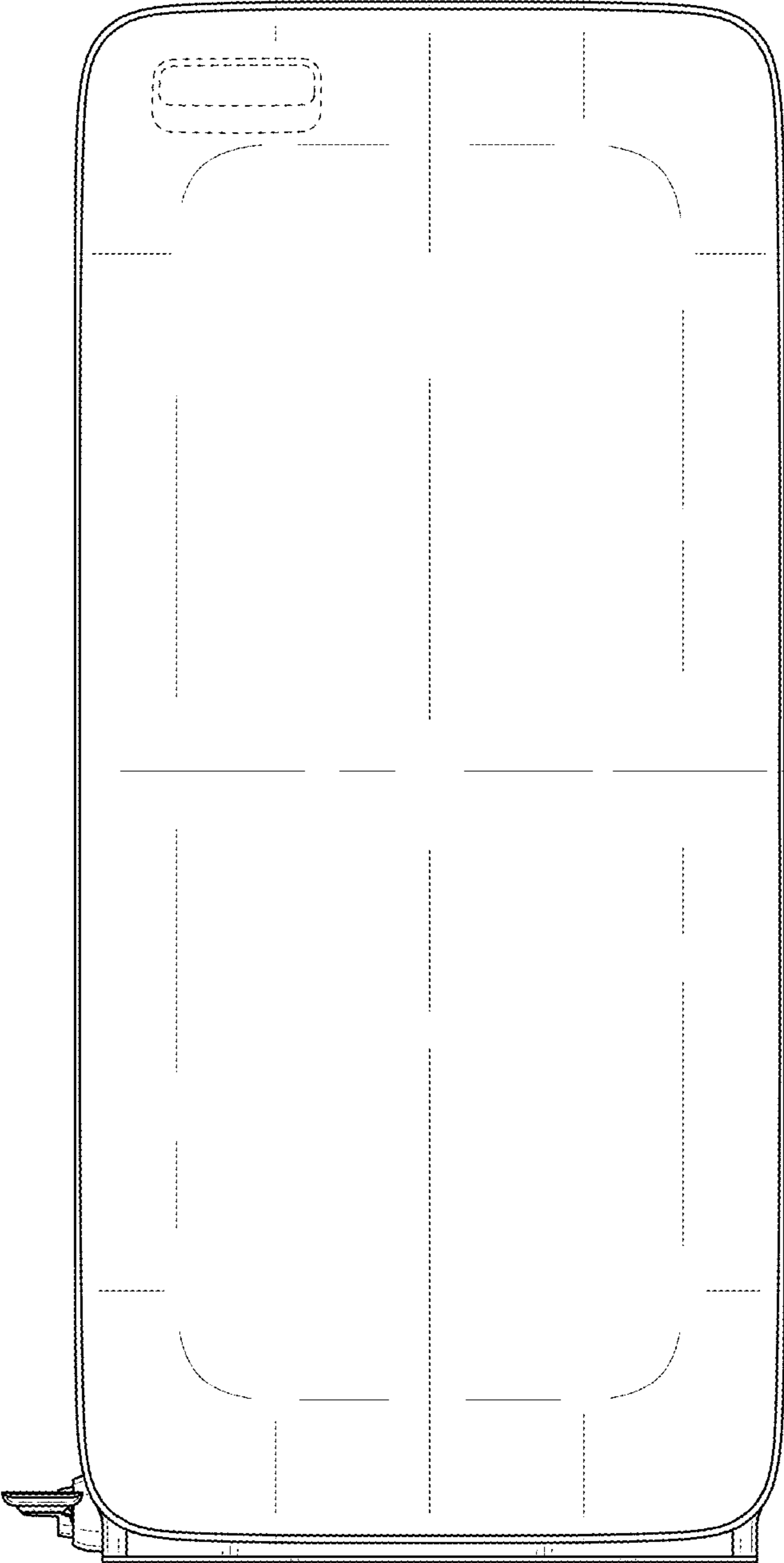

FIG. 3

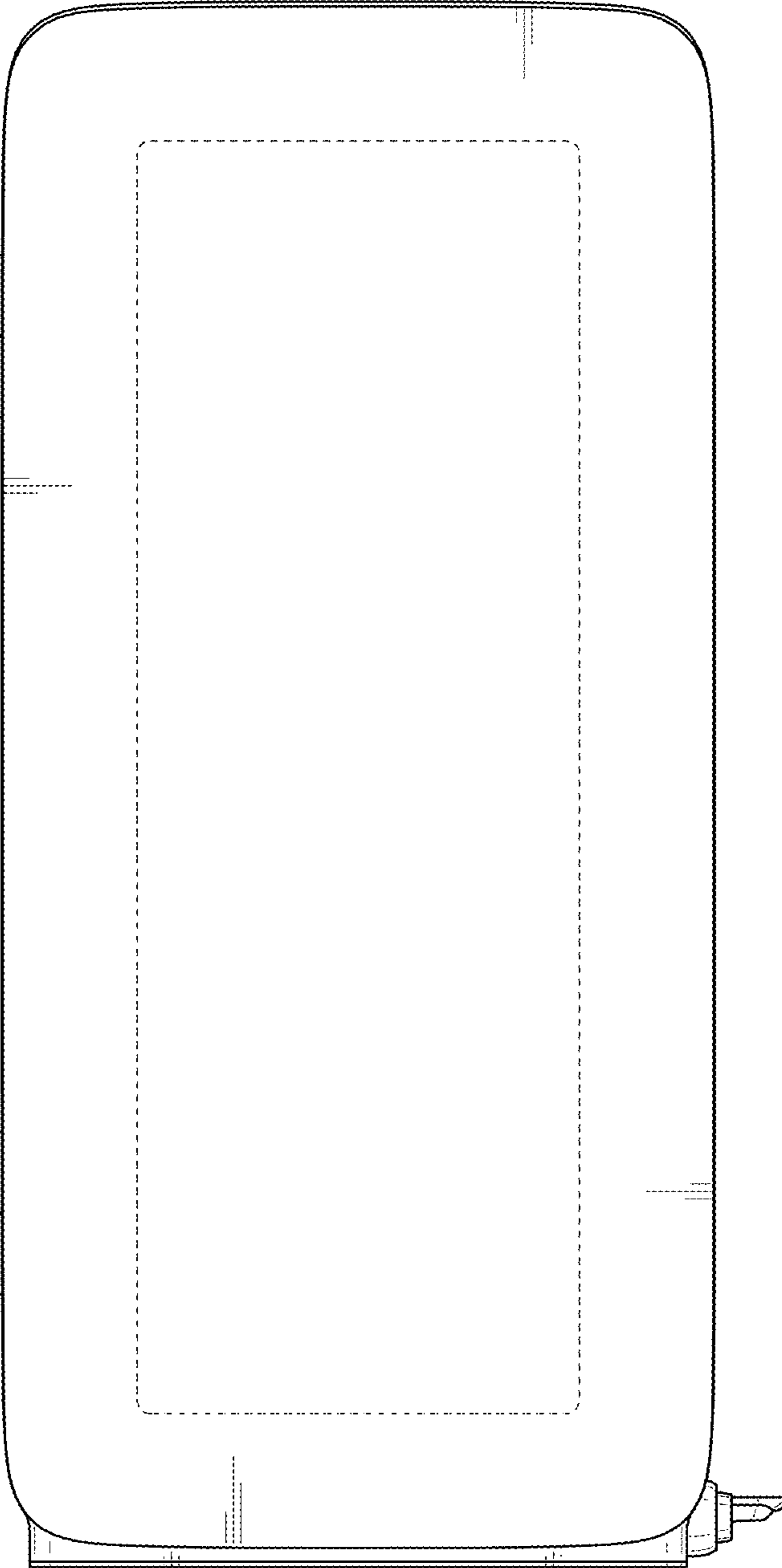

FIG. 4

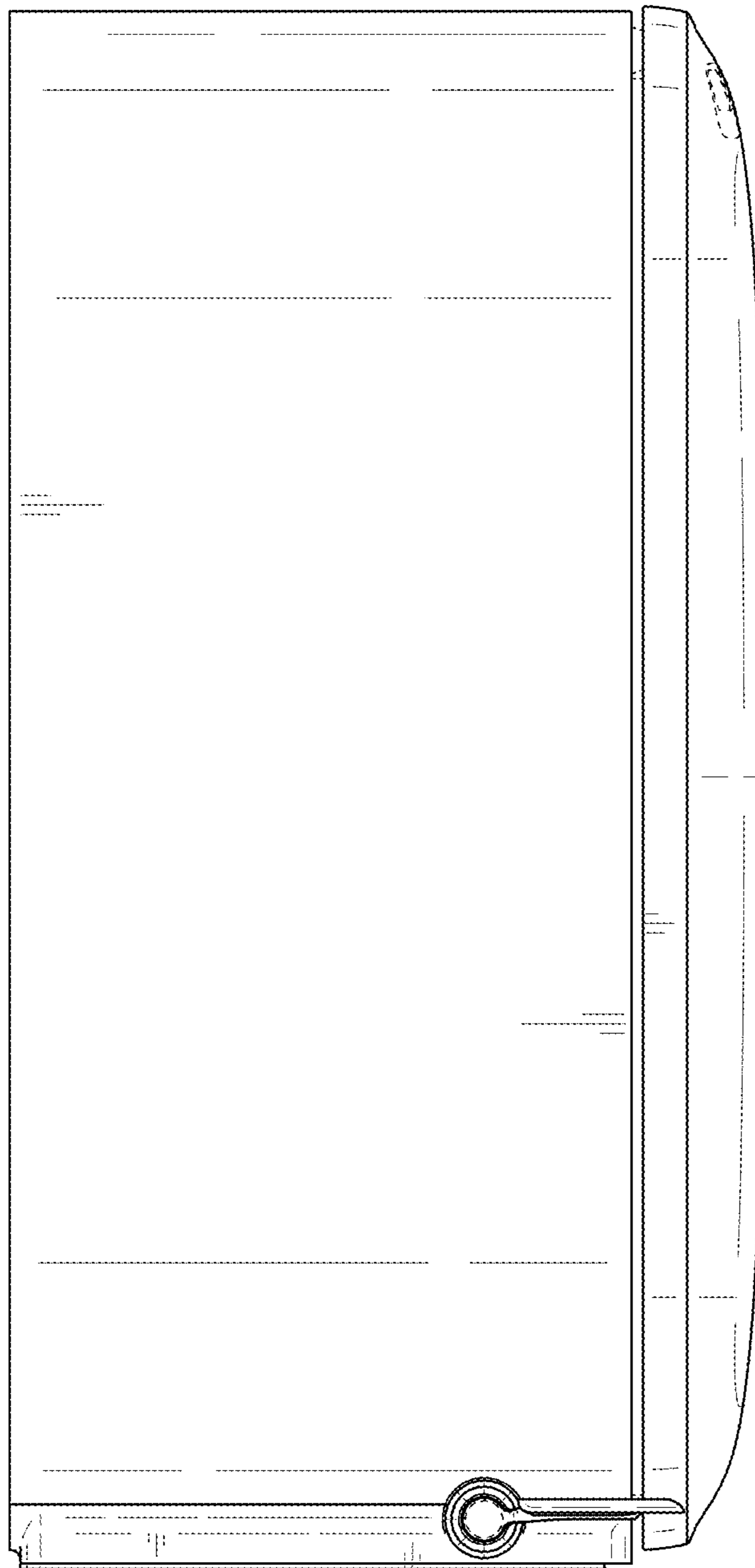

FIG. 5

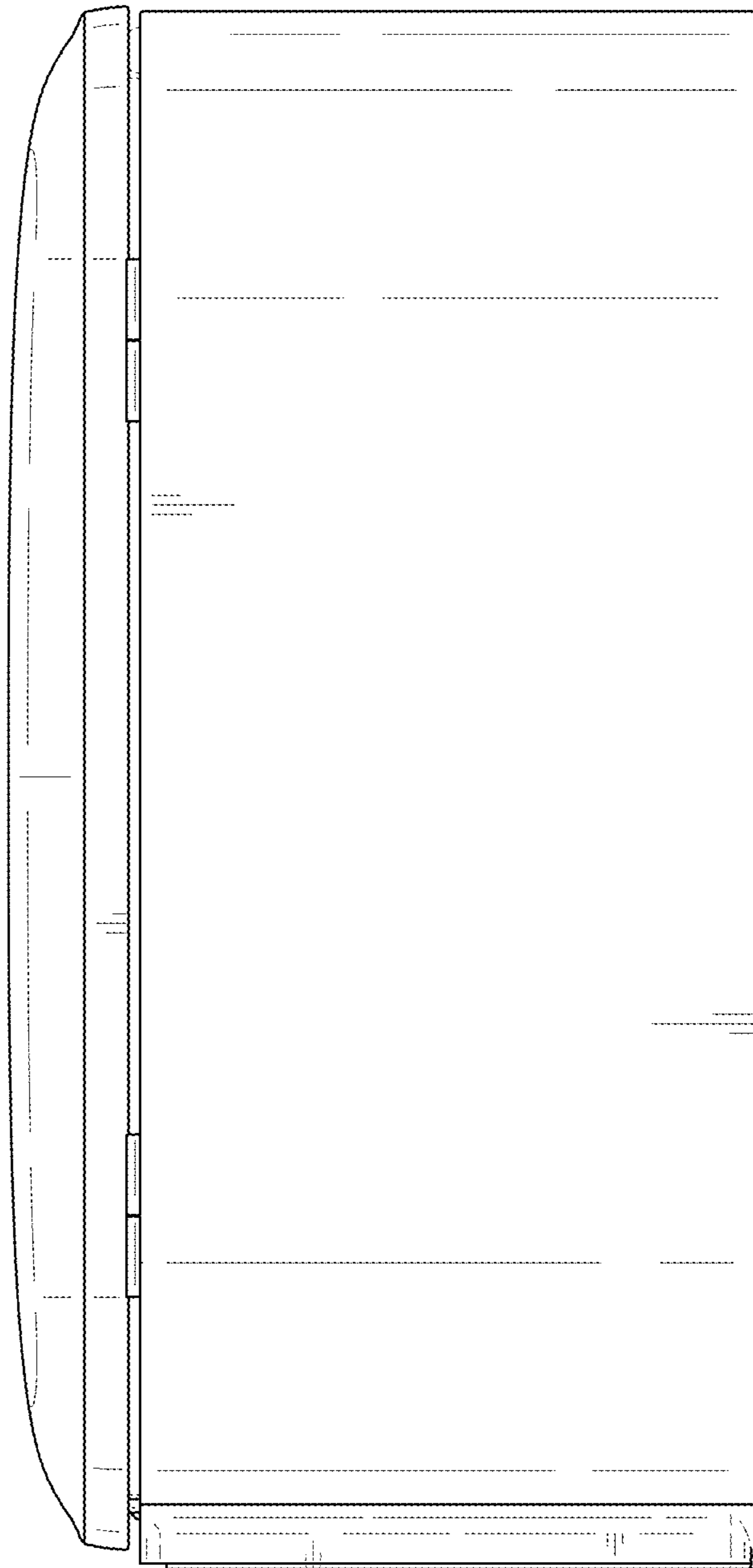

FIG. 6

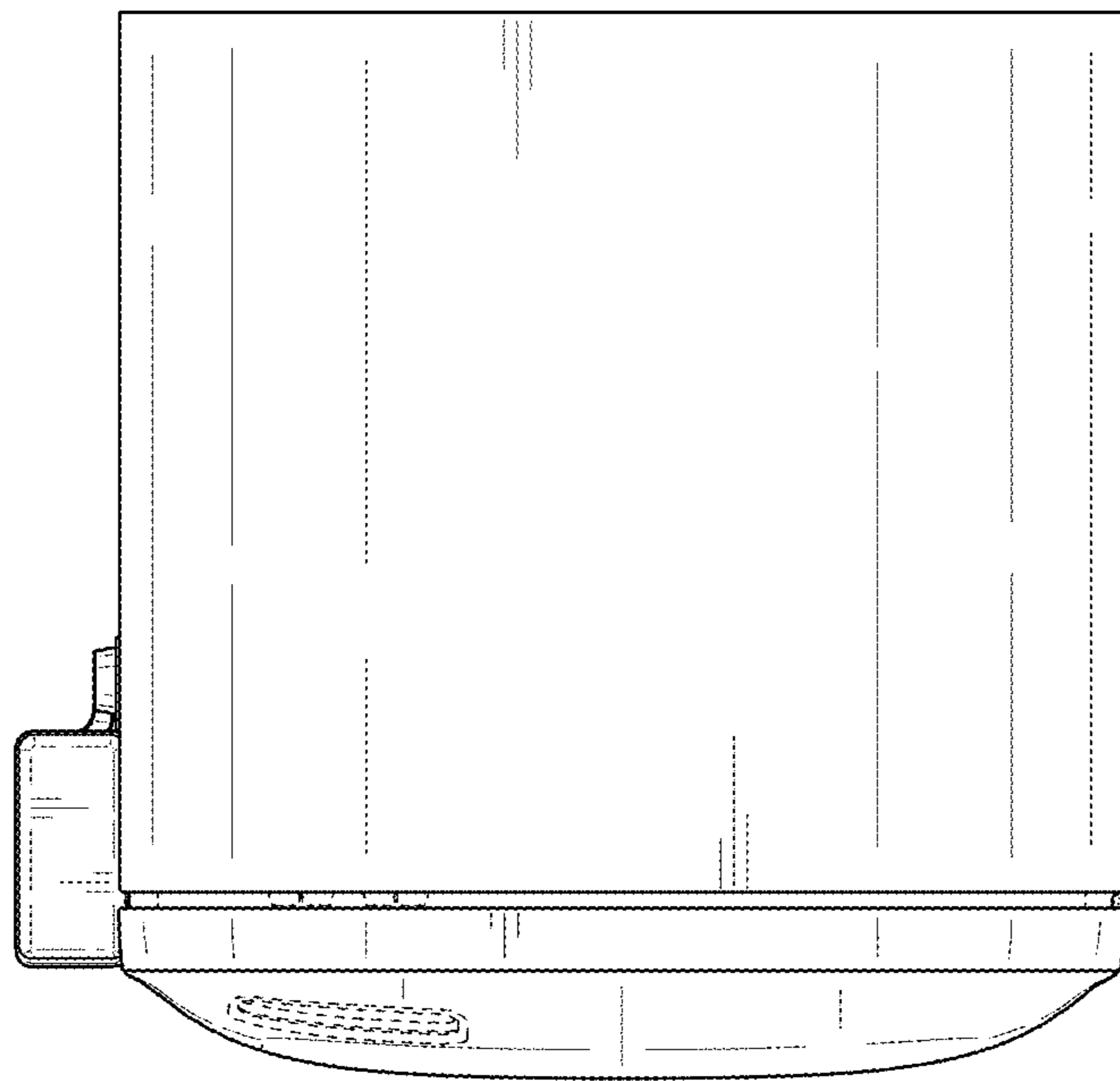

FIG. 7

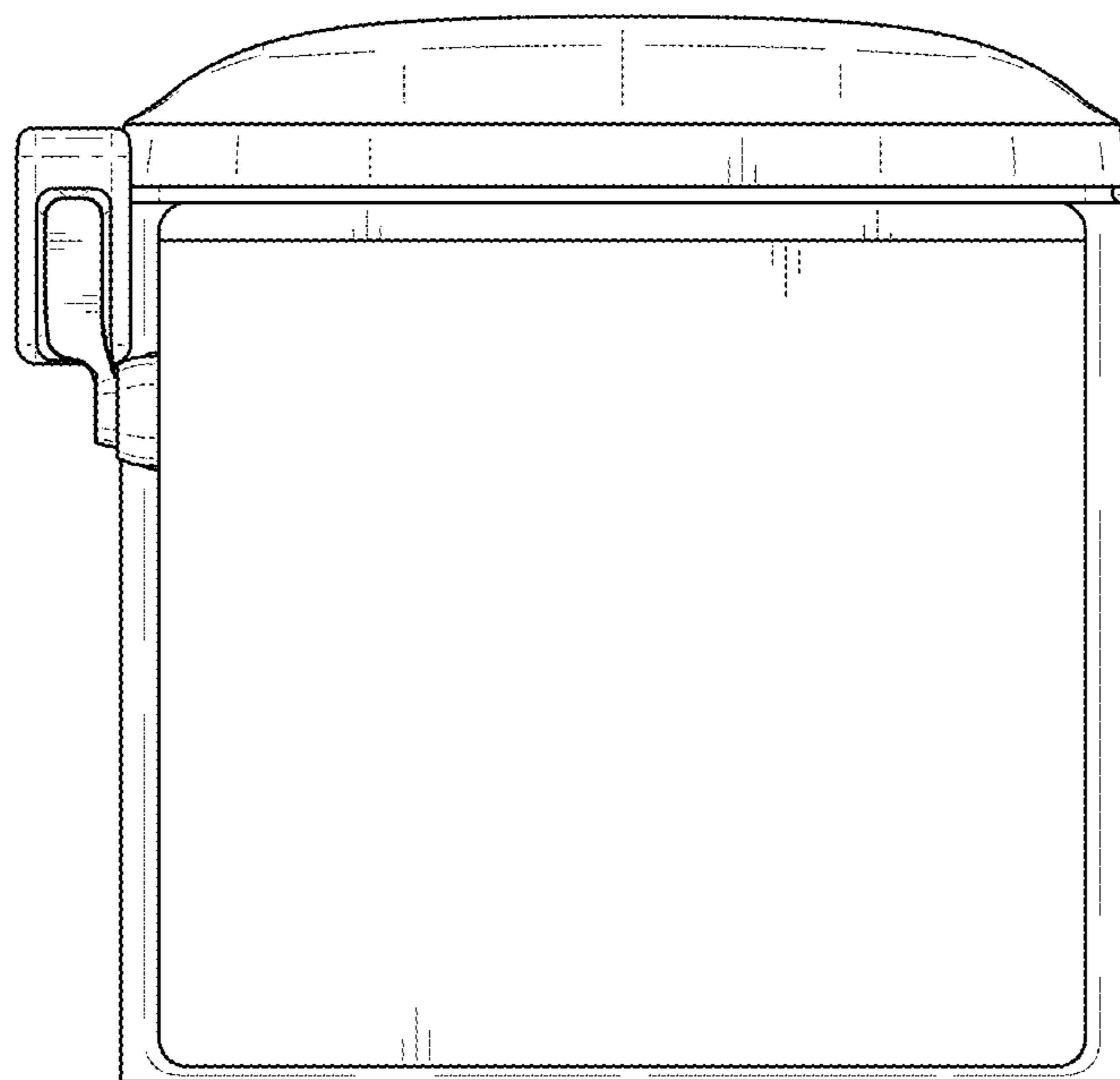

FIG. 8

